

INSTRUCTION MANUAL

TECO INVERTER



TECO INVERTER

E510s Series

E510s Instruction Manual

Table of Contents

Chapter 0 Preface.....	0-1
0.1 Preface	0-1
Chapter 1 Safety Precautions	1-1
1.1 Before Power Up.....	1-1
1.2 During Power Up.....	1-1
1.3 Before Operation	1-2
1.4 During Operation	1-3
1.5 Maintenance, Inspection and Replacement	1-3
1.6 Disposal of the Inverter	1-4
Chapter 2 Model Description	2-1
2.1 Nameplate Data.....	2-1
2.2 Model Identification	2-1
2.2.1 Invrter Model Name Identification	2-1
2.2.2 Invrter Product Name Identification	2-2
2.3 Standard Product Specification.....	2-3
Chapetr 3 Environment & Installation.....	3-1
3.1 Environment	3-1
3.2 Installation	3-5
3.2.1 Installation method	3-5
3.2.2 Installation space	3-12
3.2.3 External view	3-13
3.3 Wiring Guidelines.....	3-18

3.3.1 Power cables	3-18
3.3.2 Control cable selection and wiring	3-19
3.3.3 Wiring and EMC guidelines	3-20
3.3.4 Failure liability.....	3-21
3.3.5 Considerations for peripheral equipment	3-22
3.3.6 Ground connection.....	3-23
3.3.7 Single / Multi Pump Dedicated Wiring Diagram	3-24
3.4 Specifications	3-27
3.4.1 Product specifications	3-27
3.4.2 General specifications.....	3-31
3.4.3 De-rating curve.....	3-32
3.4.4 Capacitor reforming guide after long storage	3-36
3.5 Standard Wiring	3-37
3.6 Terminal description	3-38
3.6.1 Description of main circuit terminal.....	3-38
3.6.2 Description of control circuit terminal	3-40
3.7 Outline dimensions.....	3-42
3.8 EMC filter disconnection	3-51
3.9 The dimensions and installation of operator panel	3-52
3.9.1 Description of dimension and installation	3-52
3.9.2 Description of protective cover.....	3-53
Chapter 4 Software Index	4-1
4.1 Keypad description.....	4-1
4.1.1 Operator panel functions.....	4-1
4.1.2 Digital display description	4-2
4.1.3 LED display setup	4-4
4.1.4 Example of keypad operation.....	4-6
4.1.5 Operation control	4-8

4.1.6 LCD keypad.....	4-9
4.1.7 Keypad menu structure	4-10
4.1.8 Monitoring mode.....	4-11
4.1.9 Programming mode.....	4-12
4.1.10 Auto-tune mode	4-14
4.2 Parameters.....	4-16
4.3 Description of parameters	4-63
4.4 Built-in PLC function.....	4-251
4.4.1 Basic command	4-251
4.4.2 Basic command function.....	4-252
4.4.3 Application functions.....	4-254
Chapter 5 Troubleshooting and Fault Diagnostics.....	5-1
5.1 General.....	5-1
5.1.1 Fault detection function	5-1
5.2 General troubleshooting.....	5-15
5.3 Troubleshooting of the inverter	5-16
5.3.1 Quick troubleshooting of inverter.....	5-16
5.3.2 Troubleshooting for OC、OL error display	5-18
5.3.3 Troubleshooting for OV、LV error display.....	5-19
5.3.4 Motor not running.....	5-20
5.3.5 Motor overheating	5-21
5.3.6 Motor runs unbalanced.....	5-22
5.3.7 Auto-tuning Error	5-23
5.3.8 PM Motor Auto-tuning Error	5-23
5.4 Routine and periodic inspection	5-24
5.5 Maintenance.....	5-26
Chapter 6 Peripherals Components.....	6-1
6.1 Reactor specifications	6-1

6.2 Electromagnetic contactor circuit breaker	6-2
6.3 Fuse specification.....	6-2
6.4 Fuse specification(UL model recommended)	6-3
6.5 Brake resistor.....	6-4
6.6 Input noise filter	6-5
6.7 Accessories	6-6
Appendix 1 Instructions for UL	AP 1-1
Appendix 2 E510s parameter data	AP 2-1
Appendix 3 MODBUS Protocol Description.....	AP 3-1
Appendix 4 JN5-CM-USB Instruction	AP 4-1
Appendix 5 Accessories	AP 5-1
Appendix 6 Safety requirement specifications(SRS)	AP 6-1

Chapter 0 Preface

0.1 Preface

To extend the performance of the product and ensure personnel safety, please read this manual thoroughly before using the inverter. Should there be any problem in using the product that cannot be solved with the information provided in the manual, contact Our's technical or sales representative who will be willing to help you.

※ Precautions

The inverter is an electrical product. For your safety, there are symbols such as “Danger” , “Caution” in this manual as a reminder to pay attention to safety instructions on handling, installing, operating, and checking the inverter. Be sure to follow the instructions for highest safety.



Warning

Indicates a potential hazard that could cause death or serious personal injury if misused.



Caution

Indicates that the inverter or the mechanical system might be damaged if misused.



Danger

- Risk of electric. The DC link capacitors remains charged for five minutes after power has been removed. If it not permissible to open the equipment until 5 minutes after the power has been removed. (If the power rating of inverter is 20HP above, please open the equipment until 15 minutes after the power has been removed.)
- Do not make any connections when the inverter is powered on. Do not check parts and signals on circuit boards during the inverter operation.
- Do not disassemble the inverter or modify any internal wires, circuits, or parts.
- Ensure that the Inveter Ground terminal is connected correctly.



Caution

- Do not perform a voltage test on parts inside the inverter. High voltage can destroy the semiconductor components.
- Do not connect T1, T2, and T3 terminals of the inverter to any AC input power supply.
- CMOS ICs on the inverter's main board are susceptible to static electricity. Do not touch the main circuit board.

Chapter 1 Safety Precautions

1.1 Before Power Up

Danger

- Make sure the main circuit connections are correct Single phase L1(L),L3(N), Three phase L1(L),L2,L3(N) are power-input terminals and must not be mistaken for T1,T2 and T3. Otherwise, inverter damage can result.

Caution

- The line voltage applied must comply with the inverter's specified input voltage.(See the nameplate)
- To avoid the front cover from disengaging, or other damage do not carry the inverter by its covers. Support the drive by the heat sink when transporting. Improper handling can damage the inverter or injure personnel and should be avoided.
- To avoid the risk of fire, do not install the inverter on a flammable object.Install on nonflammable objects such as metal
- This product provides the 10V/24V for internal use only, do not use as the power supply sources for other external components, such as sensors, electronic components ... etc., otherwise it will cause adverse situation.
- When disconnecting the remote keypad, turn the power off first to avoid any damage to the keypad or the inverter.

Caution

- This product is sold subject to EN 61800-3 and EN 61800-5-1. In a domestic environment this product may cause radio interference in which case the user may be required to apply corrective measures.
- This product offers motor over temperature protection function.

Caution

- Work on the device/system by unqualified personnel or failure to comply with warnings can result in severe personal injury or serious damage to material. Only suitably qualified personnel trained in the setup, installation, commissioning and operation of the product should carry out work on the device/system.
- Only permanently-wired input power connections are allowed.

1.2 During Power Up

Danger

- Always turn OFF the power supply before attempting inverter installation and wiring of the user terminals.
- Wiring must be performed by a qualified personnel / certified electrician.
- Make sure the inverter is properly grounded. (200V Class: Grounding impedance shall be less than 100Ω. 400V Class: Grounding impedance shall be less than 10Ω.) Please connect to the earth according to EN61800-5-1 standard request, For system 430, 440, 450, 460 and 470, wiring size must be at least 10mm²(8 AWG) only can comply the standard of leakage current.

- RCD is required to be in compliance with the protection norm of B-type leakage current.
- Please check and test emergency stop circuits after wiring. (Installer is responsible for the correct wiring.)
- Never touch any of the input or output power lines directly or allow any input of output power lines to come in contact with the inverter case.
- Do not perform a dielectric voltage withstand test (megger) on the inverter this will result in inverter damage to the semiconductor components.

 **Caution**

- The line voltage applied must comply with the inverter's specified input voltage.
- Connect braking resistor and braking unit to the designated terminals.
- Do not connect a braking resistor directly to the DC terminals P (+) and N (-), otherwise fire may result.
- Use wire gauge recommendations and torque specifications.
- Never connect input power to the inverter output terminals U/T1, V/T2, W/T3.
- Do not connect a power factor correction capacitor or surge suppressor to the inverter output.
- Ensure the interference generated by the inverter and motor does not affect peripheral devices.

 **Danger**

- When the momentary power loss is longer than 2 seconds, the inverter will not have sufficient stored power for its control circuit. Therefore, when the power is re-applied, the run operation of the inverter will be based on the setting value of parameter 00-02(or 00-03) and 07-04 status of external run switch.
- When the momentary power loss is shorter, inverter still can control the power. Therefore, when the power is re-applied, the run operation of inverter will be based on the setting value of parameter 07-00.
- When the power is re-applied, the run operation of inverter will be based on the setting value of 00- 02(or 00- 03), 07- 04 and the status of power and operation switch(FWD/REVswitch)(and 07- 00/07- 01/07- 02) :
 - (1) If the parameter 00-02(or 00- 03)=0, inverter will not start automatically when the power is re-applied.
 - (2) If the parameter 00- 02(or 00- 03)=1 and the power or operation switch is open, inverter will not start automatically when the power is re-applied.
 - (3) If 00- 02(or 00- 03)=1, then power and operation switch are open (07- 04=0), inverter will restart automatically when the power is re-applied. For the safety, please turn off the power and operation switch after powered off.
- For the safety, please read the function explanation from the manual.

1.3 Before Operation

 **Caution**

- Make sure the inverter model and rating are the same as that set in parameter 13-00.

- Reduce the carrier frequency (parameter 11-01) If the cable from the inverter to the motor is greater than 80 ft (25m). A high-frequency current can be generated by stray capacitance between the cables and result in an overcurrent trip of the inverter, an increase in leakage current, or an inaccurate current readout

 **Caution**

- When the power is applied, inverter will show the voltage rating on display for 2 seconds according to the setting value of parameter 01-14.
- Do not connect a load to the motor while performing a rotational auto-tune.
- Make sure it is safe to operate the inverter and motor before performing a rotational auto-tune.

1.4 During Operation

 **Danger**

- Be sure to install all covers before turning on power
- Do not connect or disconnect the motor during operation. Otherwise, It may cause the inverter to trip or damage the unit.
- Please do not close to the equipment when the reset function is performed, equipment will restart the fault has been removed.
- Do not operate switches with wet hands, otherwise electric shock may result
- The motor will restart automatically after stop when auto-restart function is enabled. In this case, care must be taken while working around the drive and associated equipment.
- Confirm that no run command is active upon resetting the alarm or fault, otherwise accidents may occur.
- If automatic restart after power recovery (parameter 07-00) is enabled, the inverter will start automatically after power is restored
- Do not touch inverter terminals when energized even if inverter has stopped, otherwise electric shock may result.
- It is not permissible to open the equipment until 5 minutes after the power has been removed. ° (if the inverter rating is 15HP above, please open the equipment until 15 minutes after the power has been removed.

 **Caution**

- Do not touch heat-generating components such as heat sink and braking resistors.
- Carefully check the performance of motor or machine before operating at high speed, otherwise Injury may result.
- Note the parameter settings related to the braking unit when applicable.
- After the power is turned off, the cooling fan may continue to run for some time.
- Do not check signals on circuit boards while the inverter is running.

1.5 Maintenance, Inspection and Replacement

 **Warning**

- Wait a minimum of five minutes after power has been turned OFF before starting an inspection. Also confirm that the charge light is OFF and that the DC bus voltage has dropped below 25Vdc.
- Never touch high voltage terminals in the inverter.

- Make sure power to the inverter is disconnected before disassembling the inverter.
- Only authorized personnel should perform maintenance, inspection, and replacement operations. (Take off metal jewelry such as watches and rings and use insulated tools.)

 **Caution**

- The Inverter can be used in an environment with a temperature range from 14° ~104(°F) or -10~+50(°C1.6) and relative humidity of 95% non-condensing.
- The inverter must be operated in a dust, gas, mist and moisture free environment.
 - * -10°C~+50°C (suitable for the product which without dust cover or sticker)
 - * -10°C~+40°C (suitable for the product which with dust cover or sticker)

1.6 Disposal of the Inverter

 **Caution**

- Please dispose of this unit with care as an industrial waste and according to your required local regulations.
- The capacitors of inverter main circuit and printed circuit board are considered as hazardous waste and must not be burned.
- The Plastic enclosure and parts of the inverter such as the top cover board will release harmful gases if burned.

 Equipment containing electrical components may not be disposed of together with domestic waste. It must be separately collected with electrical and electronic waste according to local and currently valid legislation.

Chapter 2 Model Description

2.1 Nameplate Data

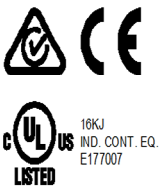
Product name & Motor rating	PRODUCT: E510-2P5-SH	MOTOR RATING: 0.5HP	
Input power specifications	INPUT : AC 1/3PH 200-240V (+10%,-15%) 50/60Hz 8.5/4.5A		
Output power specifications	OUTPUT : AC 3PH 0-240V 0-599 Hz 3.1A	IP20/NEMA1	
Model name	MODEL : 11-201-20-2P5-00		

(P/N code)	(S/N code)
------------	------------

TECO TECO Electric & Machinery Co., Ltd.

2.2 Model Identification

2.2.1 Inverter Model Name Identification

A B - C D E - F G - H I J - K L

A : Product	F : Standard voltage	H-J : Horse Power
1 : Inverter	1 : 100-120V	0P5 : 0.5HP
2 : SERVO	2 : 200-240V	001 : 1HP
3 : PLC	4 : 380-480V	075 : 75HP
B : UL Category	G : Phase	K : EMC Filter
0 : UL Recognized	0 : Single/Three phase	0 : Without built-in
1 : UL Listed	1 : Single phase	3 : Built-in+STO
	3 : Three phase	
C-E : Serial number		L : Protection Level
001-999		0 : IP20
		3 : NEMA1
		6 : IP66

2.2.2 Inverter Product Name Identification

E510 - 2 - 01 - S H - 1 - F - N4S

2 : Standard Voltage

2 : 200-240V

4 : 380-480V

S : 510s series

1 : Phase

1 : Single phase

3 : Three phase

Blank : Single/Three phase

01 : Horse Power

P5 : 0.5HP

01 : 1.0HP

02 : 2.0HP

03 : 3.0HP

05 : 5.0HP

08 : 7.5HP

10 : 10HP

15 : 15HP

20 : 20HP

25 : 25HP

30 : 30HP

40 : 40HP

50 : 50HP

60 : 60HP

75 : 75HP

H : Standard Product

F : EMC Filter

F : Built-in+STO

Blank : Without built-in

N4S : IP66 type

N4 : Built-in VR

N4S : Built-in power
switch, VR, EMC
filter and STO

2.3 Standard Product Specification

IP20 type 200V Class

Model Name	TECO Product Name	Supply voltage (VAC)	Horse power (HP)	Motor (kW)	EMC filter	STO function	Frame size
11-201-20-2P5-00	E510-2P5-SH	1/3 Phase 200~240V +10% ~ -15% 50/60Hz	0.5	0.4			1
11-201-20-201-00	E510-201-SH		1	0.75			1
11-201-20-202-00	E510-202-SH		2	1.5			2
11-201-20-203-00	E510-203-SH		3	2.2			2
11-301-21-2P5-30	E510-2P5-SH1F	1 Phase 200~240V +10% ~ -15% 50/60Hz	0.5	0.4	◎	◎	1
11-301-21-201-30	E510-201-SH1F		1	0.75	◎	◎	1
11-301-21-202-30	E510-202-SH1F		2	1.5	◎	◎	2
11-301-21-203-30	E510-203-SH1F		3	2.2	◎	◎	2
11-201-23-202-00	E510-202-SH3	3 Phase 200~240V +10% ~ -15% 50/60Hz	2	1.5			1
11-201-23-205-00	E510-205-SH3		5	4			2
11-201-23-208-00	E510-208-SH3		7.5	5.5			3
11-201-23-210-00	E510-210-SH3		10	7.5			3
11-201-23-215-00	E510-215-SH3		15	11			4
11-201-23-220-00	E510-220-SH3		20	15			4
11-201-23-225-00	E510-225-SH3		25	18.5 / 22			5
11-201-23-230-00	E510-230-SH3		30	22 / 30			6
11-201-23-240-00	E510-240-SH3		40	30 / 37			6
*** EMC filter models are built-in STO function.							

IP20 type 400V Class

Model Name	TECO Product Name	Supply voltage (VAC)	Horse power (HP)	Motor (kW)	EMC filter	STO function	Frame size	
11-201-43-401-00	E510-401-SH3	3 Phase 380~480V +10% ~ -15% 50/60Hz	1	0.75			1	
11-201-43-402-00	E510-402-SH3		2	1.5			1	
11-201-43-403-00	E510-403-SH3		3	2.2			2	
11-201-43-405-00	E510-405-SH3		5	4			2	
11-201-43-408-00	E510-408-SH3		7.5	5.5			3	
11-201-43-410-00	E510-410-SH3		10	7.5			3	
11-201-43-415-00	E510-415-SH3		15	11			3	
11-201-43-420-00	E510-420-SH3		20	15			4	
11-201-43-425-00	E510-425-SH3		25	18.5			4	
11-201-43-430-00	E510-430-SH3		30	22 / 30			5	
11-201-43-440-00	E510-440-SH3		40	30 / 37			6	
11-201-43-450-00	E510-450-SH3		50	37 / 45			6	
11-201-43-460-00	E510-460-SH3		60	45 / 55			6	
11-201-43-475-00	E510-475-SH3		75	55 / 75			6	
11-301-43-401-30	E510-401-SH3F			1	0.75	◎	◎	1
11-301-43-402-30	E510-402-SH3F			2	1.5	◎	◎	1
11-301-43-403-30	E510-403-SH3F			3	2.2	◎	◎	2
11-301-43-405-30	E510-405-SH3F			5	4	◎	◎	2
11-301-43-408-30	E510-408-SH3F			7.5	5.5	◎	◎	3
11-301-43-410-30	E510-410-SH3F			10	7.5	◎	◎	3
11-301-43-415-30	E510-415-SH3F			15	11	◎	◎	3
11-301-43-420-30	E510-420-SH3F			20	15	◎	◎	4
11-301-43-425-30	E510-425-SH3F			25	18.5	◎	◎	4
11-301-43-430-30	E510-430-SH3F			30	22 / 30	◎	◎	5
11-301-43-440-30	E510-440-SH3F			40	30 / 37	◎	◎	6
11-301-43-450-30	E510-450-SH3F		50	37 / 45	◎	◎	6	
11-301-43-460-30	E510-460-SH3F		60	45 / 55	◎	◎	6	
11-301-43-475-30	E510-475-SH3F		75	55 / 75	◎	◎	6	

*** EMC filter models are built-in STO function.

※ Uses Footprint type EMC filter

IP66 type 200V Class

Model Name	TECO Product Name	Supply voltage (VAC)	Horse power (HP)	Motor (kW)	Power Switch	EMC filter	STO function	Frame size	
11-301-21-2P5-36S	E510-2P5-SH1FN4S	1 Phase 200~240V +10% ~ -15% 50/60Hz	0.5	0.4	◎	◎	◎	1	
11-301-21-201-36S	E510-201-SH1FN4S		1	0.75	◎	◎	◎	1	
11-301-21-202-36S	E510-202-SH1FN4S		2	1.5	◎	◎	◎	2	
11-301-21-203-36S	E510-203-SH1FN4S		3	2.2	◎	◎	◎	2	
11-301-21-2P5-36	E510-2P5-SH1FN4		0.5	0.4		◎	◎	1	
11-301-21-201-36	E510-201-SH1FN4		1	0.75		◎	◎	1	
11-301-21-202-36	E510-202-SH1FN4		2	1.5		◎	◎	2	
11-301-21-203-36	E510-203-SH1FN4		3	2.2		◎	◎	2	
11-201-20-2P5-06	E510-2P5-SHN4		1/3 Phase 200~240V +10% ~ -15% 50/60Hz	2	1.5				1
11-201-20-201-06	E510-201-SHN4			5	4				1
11-201-20-202-06	E510-202-SHN4	7.5		5.5				2	
11-201-20-203-06	E510-203-SHN4	10		7.5				2	
11-201-23-205-06	E510-205-SH3N4	3 Phase 200~240V +10% ~ -15% 50/60Hz	15	11				2	
11-201-23-208-06	E510-208-SH3N4		20	15				3	
11-201-23-210-06	E510-210-SH3N4		25	18.5 / 22				3	
11-201-23-215-06	E510-215-SH3N4		30	22 / 30				3	
11-201-23-220-06	E510-220-SH3N4		40	30 / 37				3	

IP66 type 400V Class

Model Name	TECO Product Name	Supply voltage (VAC)	Horse power (HP)	Motor (kW)	Power Switch	EMC filter	STO function	Frame size
11-301-43-401-36S	E510-401-SH3FN4S	3 Phase 380~480V +10% ~ -15% 50/60Hz	1	0.75	☉	☉	☉	1
11-301-43-402-36S	E510-402-SH3FN4S		2	1.5	☉	☉	☉	1
11-301-43-403-36S	E510-403-SH3FN4S		3	2.2	☉	☉	☉	2
11-301-43-405-36S	E510-405-SH3FN4S		5	4	☉	☉	☉	2
11-301-43-408-36S	E510-408-SH3FN4S		7.5	5.5	☉	☉	☉	3
11-301-43-410-36S	E510-410-SH3FN4S		10	7.5	☉	☉	☉	3
11-301-43-415-36S	E510-415-SH3FN4S		15	11	☉	☉	☉	3
11-301-43-401-36	E510-401-SH3FN4		1	0.75		☉	☉	1
11-301-43-402-36	E510-402-SH3FN4		2	1.5		☉	☉	1
11-301-43-403-36	E510-403-SH3FN4		3	2.2		☉	☉	2
11-301-43-405-36	E510-405-SH3FN4		5	4		☉	☉	2
11-301-43-408-36	E510-408-SH3FN4		7.5	5.5		☉	☉	3
11-301-43-410-36	E510-410-SH3FN4		10	7.5		☉	☉	3
11-301-43-415-36	E510-415-SH3FN4		15	11		☉	☉	3
11-201-43-401-06	E510-401-SH3N4		1	0.75				1
11-201-43-402-06	E510-402-SH3N4		2	1.5				1
11-201-43-403-06	E510-403-SH3N4		3	2.2				2
11-201-43-405-06	E510-405-SH3N4		5	4				2
11-201-43-408-06	E510-408-SH3N4		7.5	5.5				3
11-201-43-410-06	E510-410-SH3N4		10	7.5				3
11-201-43-415-06	E510-415-SH3N4		15	11				3
11-201-43-420-06	E510-420-SH3N4		20	15				3
11-201-43-425-06	E510-425-SH3N4		25	18.5				3

Chapter3 Environment & Installation

3.1 Environment

Installation environment has a direct effect on the correct operation and the life expectancy of the inverter, Install the inverter in an environment complying with the following conditions :

Protection	
Protection class	IP20 / NEMA 1 & IP66
Suitable Environment	
Operation temperature	IP20 / NEMA 1 type : (please refer the ambient temperature and rating current curves in section 3.4.3) Inside distributor : -10~50°C(without sticker or dust cover)(up to 60°C) Output distributor : -10~40°C(with sticker or dust cover)(up to 50°C) (It is required to derate 1.5% of output current at each additional degrees once the ambient temperature is higher than 50 degrees.) If several inverters are installed in the same Operator panel, ensure adequate spacing and provide the necessary cooling and ventilation for successful operation. **Please does not exceed 70% rated current of inverter with dust sticker or over.
Storage temperature	-20 ~ 60°C
Relative Humidity	Relative humidity 5% to 95%, free of moisture. (Follow IEC60068-2-78 standard)
Vibration	Frequency : 10Hz to 150Hz and return to 10Hz Amplitude : 0.3mm (10Hz to 50Hz) Acceleration : 2G (50Hz to 150Hz) (According to IEC60068-2-6 standard)
Altitude	It's required to derate 1% of output current at each additional 100m. (2000m max)

Installation side

Install in an environment that will not have an adverse effect on the operation of the unit and ensure that there is no exposure to areas such as that listed below :

- Direct sunlight, Rain or moisture.
- Oil mist, salt, corrosive liquid and gas.
- Electromagnetic interference, radioactive and flammable materials
- Excessive vibration from machines such as stamping, punching machines, add a vibration-proof pads if necessary.

Inverter Rated Current v.s Ambient Temperature

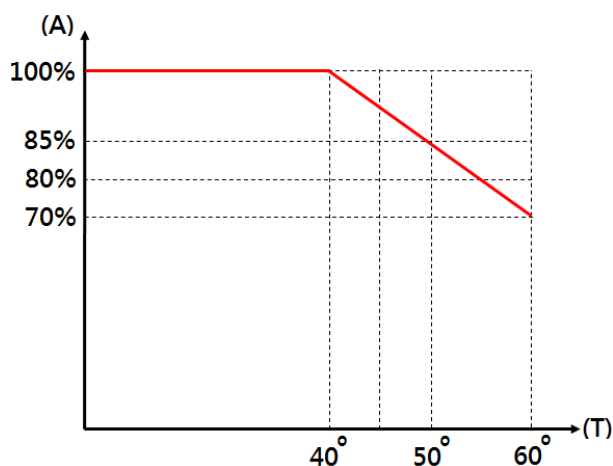

Wire gauges and tightening torque

To comply with UL standards, use UL approved copper wires (rated 75° C) and round crimp terminals (UL Listed products) as shown in table below when connecting to the main circuit terminals. TECO recommends using crimp terminals manufactured by NICHIFU Terminal Industry Co., Ltd and the terminal crimping tool recommended by the manufacturer for crimping terminals and the insulating sleeve.

Wire size mm ² (AWG)	Terminal Screw size	Model of the round crimp terminal	Fastening torque kgf.cm (in.lbs)	Model of insulating sleeve	Model of crimp tool
0.75 (18)	M3.5	R1.25-3.5	8.2 to 10 (7.1 to 8.7)	TIC 1.25	NH 1
	M4	R1.25-4	12.2 to 14 (10.4 to 12.1)	TIC 1.25	NH 1
1.25 (16)	M3.5	R1.25-3.5	8.2 to 10 (7.1 to 8.7)	TIC 1.25	NH 1
	M4	R1.25-4	12.2 to 14 (10.4 to 12.1)	TIC 1.25	NH 1
2 (14)	M3.5	R2-3.5	8.2 to 10 (7.1 to 8.7)	TIC 2	NH 1 / 9
	M4	R2-4	12.2 to 14 (10.4 to 12.1)	TIC 2	NH 1 / 9
	M5	R2-5	22.1 to 24 (17.7 to 20.8)	TIC 2	NH 1 / 9
	M6	R2-6	25.5 to 30.0 (22.1 to 26.0)	TIC 2	NH 1 / 9
3.5/5.5 (12/10)	M4	R5.5-4	12.2 to 14 (10.4 to 12.1)	TIC 3.5/5.5	NH 1 / 9
	M5	R5.5-5	20.4 to 24 (17.7 to 20.8)	TIC 3.5/5.5	NH 1 / 9
	M6	R5.5-6	25.5 to 30.0 (22.1 to 26.0)	TIC 3.5/5.5	NH 1 / 9
	M8	R5.5-8	61.2 to 66.0 (53.0 to 57.2)	TIC 3.5/5.5	NH 1 / 9
8 (8)	M4	R8-4	12.2 to 14 (10.4 to 12.1)	TIC 8	NOP 60
	M5	R8-5	20.4 to 24 (17.7 to 20.8)	TIC 8	NOP 60
	M6	R8-6	25.5 to 30.0 (22.1 to 26.0)	TIC 8	NOP 60
	M8	R8-8	61.2 to 66.0 (53.0 to 57.2)	TIC 8	NOP 60
14 (6)	M4	R14-4	12.2 to 14 (10.4 to 12.1)	TIC 14	NH 1 / 9
	M5	R14-5	20.4 to 24 (17.7 to 20.8)	TIC 14	NH 1 / 9
	M6	R14-6	25.5 to 30.0 (22.1 to 26.0)	TIC 14	NH 1 / 9
	M8	R14-8	61.2 to 66.0 (53.0 to 57.2)	TIC 14	NH 1 / 9
22 (4)	M6	R22-6	25.5 to 30.0 (22.1 to 26.0)	TIC 22	NOP 60/ 150H
	M8	R22-8	61.2 to 66.0 (53.0 to 57.2)	TIC 22	NOP 60/ 150H
30/38 (3 / 2)	M6	R38-6	25.5 to 30.0 (22.1 to 26.0)	TIC 38	NOP 60/ 150H
	M8	R38-8	61.2 to 66.0 (53.0 to 57.2)	TIC 38	NOP 60/ 150H
50 / 60 (1 / 1/0)	M8	R60-8	61.2 to 66.0 (53.0 to 57.2)	TIC 60	NOP 60/ 150H
	M10	R60-10	102 to 120 (88.5 to 104)	TIC 60	NOP 150H
70 (2/0)	M8	R70-8	61.2 to 66.0 (53.0 to 57.2)	TIC 60	NOP 150H
	M10	R70-10	102 to 120 (88.5 to 104)	TIC 60	NOP 150H
80 (3/0)	M10	R80-10	102 to 120 (88.5 to 104)	TIC 80	NOP 150H
	M16	R80-16	255 to 280 (221 to 243)	TIC 80	NOP 150H
100 (4/0)	M10	R100-10	102 to 120 (88.5 to 104)	TIC 100	NOP 150H
	M12	R100-12	143 to 157 (124 to 136)	TIC 100	NOP 150H
	M16	R80-16	255 to 280 (221 to 243)	TIC 80	NOP 150H

Tighting Torque for Terminals

Model	TM1(Power Terminal)				
	Wiring Size		Tighting Torque		
	AWG	mm ²	kgf.cm	lbf.in	Nm
Frame 1(200V)	14	2.5	9.8	8.5	0.96
Frame 1(400V)	14-12	2.5-10	9.8	8.5	0.96
Frame 2(200V)	14-12	2.5-4	18.4	15.9	1.8
Frame 2(400V)	14-8	2.5-10	18.4	15.9	1.8
Frame 3	12-6	4-16	24.5	21.2	2.4
Frame 4	8	10	24.5	21.2	2.4
Frame 5	6	16	30	26	2.9
Frame 6	0	50	81.7	70.7	8

Model	TM2(Control Terminal)				
	Wiring Size		Tighting Torque		
	AWG	mm ²	kgf.cm	lbf.in	Nm
Frame 1~2	26~18	0.5~0.15	5.7	5	0.56
Frame 3~4	16	0.5~0.15	8	7	0.79
Frame 5~6	14	0.5~0.15	8	7	0.79

Specifications for terminals

Frame size	Horsepower	Power specification	Voltage (Volt)	Current (A)
Frame1	0.5/1/2(-H3)	200V ~ 240V	600	20
	1/2	380V ~ 480V		
Frame2	2(-H)/3/5	200V ~ 240V	600	45
	3/5	380V ~ 480V		
Frame 3/4	7.5/10/15/20	200V ~ 240V	600	100
	7.5/10/15/20/25	380V ~ 480V	600	65
Frame 5	25	200V ~ 240V	600	100
	30	380V ~ 480V	600	75
Frame 6	30/40	200V ~ 240V	600	175
	40/50/60/75	380V ~ 480V	600	

Wiring specifications

Model No.	Case Frame	Total weight	Input wiring	Output wiring
11-301-21-2P5-30 11-301-21-201-30	Frame 1, 174 x 91 x 149 mm	1.9 kg	14 AWG (2.5 mm ²)	14 AWG (2.5 mm ²)
11-301-21-202-30 11-301-21-203-30	Frame 2, 198 x 129 x 150 mm	2.8 kg	14 – 8 AWG (2.5 – 10 mm ²)	14 – 8 AWG (2.5 – 10 mm ²)
11-301-43-401-30 11-301-43-402-30	Frame 1, 174 x 91 x 149 mm	1.9 kg	14 – 12 AWG (2.5 – 4.0 mm ²)	14 – 12 AWG (2.5 – 4.0 mm ²)
11-301-43-403-30 11-301-43-405-30	Frame 2, 198 x 129 x 150 mm	2.8 kg	14 – 8 AWG (2.5 – 10 mm ²)	14 – 8 AWG (2.5 – 10 mm ²)
11-301-43-408-30 11-301-43-410-30 11-301-43-415-30	Frame 3, 273 x 187 x 198 mm	7.1 kg	12 – 6 AWG (4.0 – 16 mm ²)	12 – 6 AWG (4.0 – 16 mm ²)
11-301-43-420-30 11-301-43-425-30	Frame 4, 400 x 236 x 261 mm	13.9 kg	8 AWG (10 mm ²)	8 AWG (10 mm ²)
11-301-43-430-30	Frame 5, 463 x 269 x 313 mm	15.56 kg	6 AWG (16 mm ²)	6 AWG (16 mm ²)
11-301-43-440-30 11-301-43-450-30 11-301-43-460-30 11-301-43-475-30	Frame 6, 653 x 289 x 364 mm	38.72 kg	0 AWG (50 mm ²)	0 AWG (50 mm ²)

Brake Circuit Specifications

Model	Manufacturer	Type	Rating
11-301-21-2P5-XX	Bussmann	16CT	690V 16A
11-301-21-201-XX	Bussmann	20CT	690V 20A
11-301-21-202-XX	Bussmann	32FE	690V 32A
11-301-21-203-XX	Bussmann	50FE	690V 50A
11-301-43-401-XX	Bussmann	10CT	690V 10A
11-301-43-402-XX	Bussmann	16CT	690V 16A
11-301-43-403-XX	Bussmann	16CT	690V 16A
11-301-43-405-XX	Bussmann	20CT	690V 20A
11-301-43-408-XX	Bussmann	32FE	690V 32A
11-301-43-410-XX	Bussmann	40FE	690V 40A
11-301-43-415-XX	Bussmann	63FE	690V 63A
11-301-43-420-XX	Bussmann	71FE	690V 71A
11-301-43-425-XX	Bussmann	100FEa	690V 100A
11-301-43-430-30	Bussmann	100FEa	690V 100A
11-301-43-440-30	FERRAZ SHAWMUT	A50QS125-4	500V 125A
11-301-43-450-30	FERRAZ SHAWMUT	A50QS175-4	500V 175A
11-301-43-460-30	FERRAZ SHAWMUT	A50QS200-4	500V 200A
11-301-43-475-30	FERRAZ SHAWMUT	A50QS300-4	500V 300A

3.2 Installation

3.2.1 Installation method

➤ IP20 / NEMA 1 standard installation

(a) 200V 0.5HP~1HP / 400V 1HP~2HP / 200V 2HP(Three phase)

▪ IP20

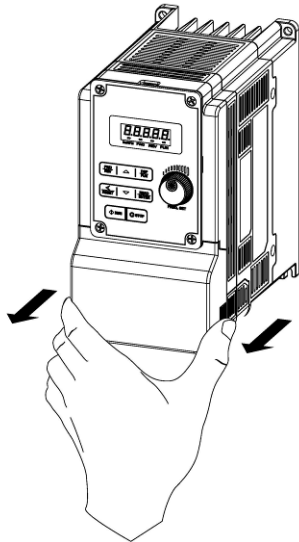

Step1 : Remove the terminal cover

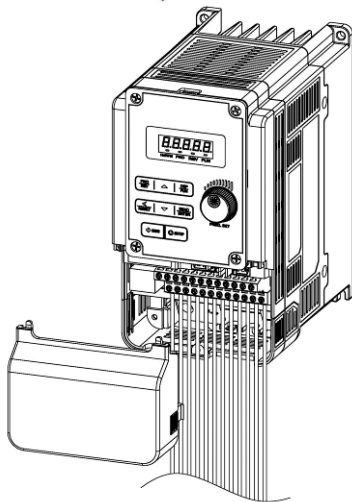

Step2 : Wire & Re-install cover

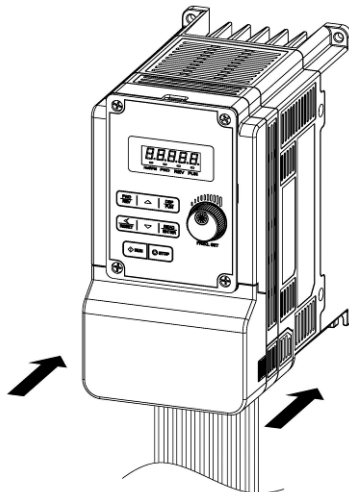

Step3 : Put the terminal cover back

▪ NEMA1

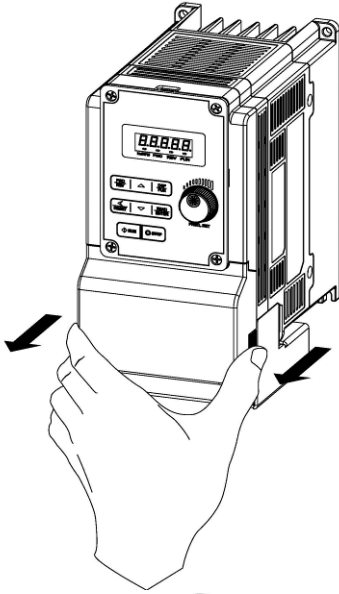

Step1 : Remove the terminal cover

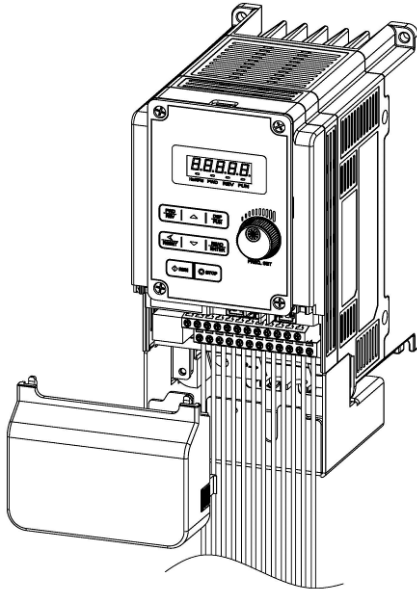

Step2 : Wire&Re-install the cover

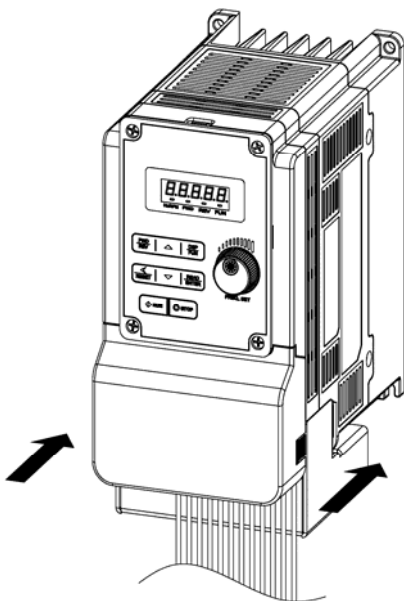

Step3 : Put the terminal cover back

(b) 200V 2HP(single/three phase) / 200V 3HP~20HP / 400V 3HP~25HP

▪ IP20

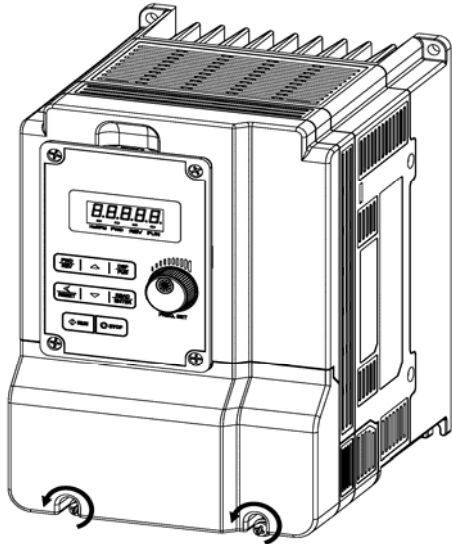

Step1 : Loosen the screws

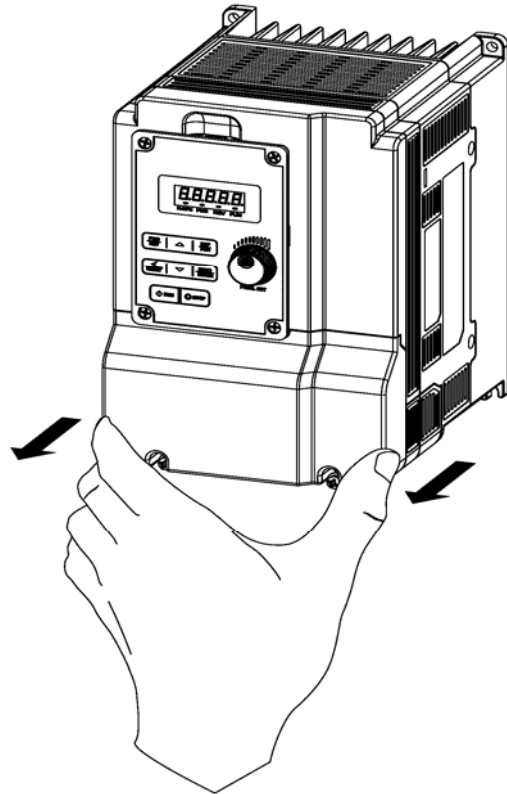

Step2 : Remove the terminal cover

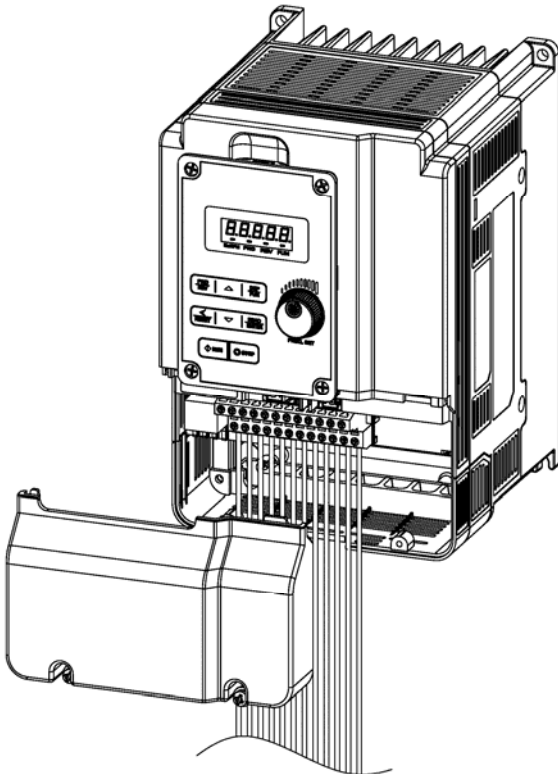

Step3 : Wire&Re-install the cover

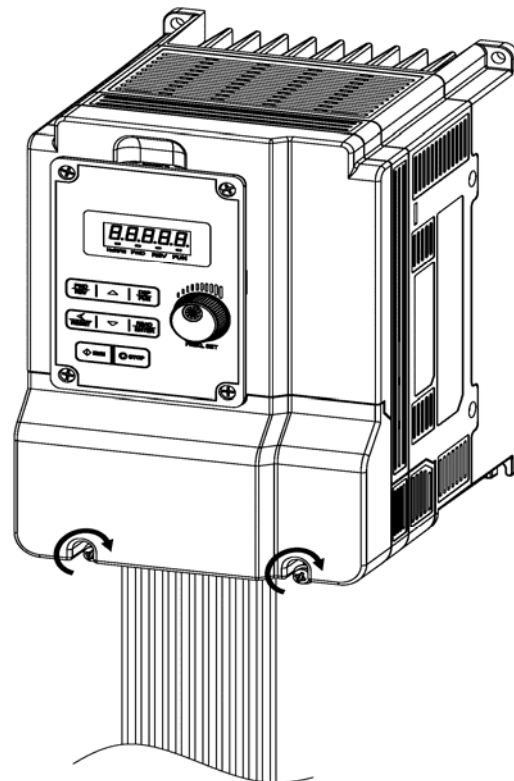

Step4 : Tighten the screws

▪ NEMA1

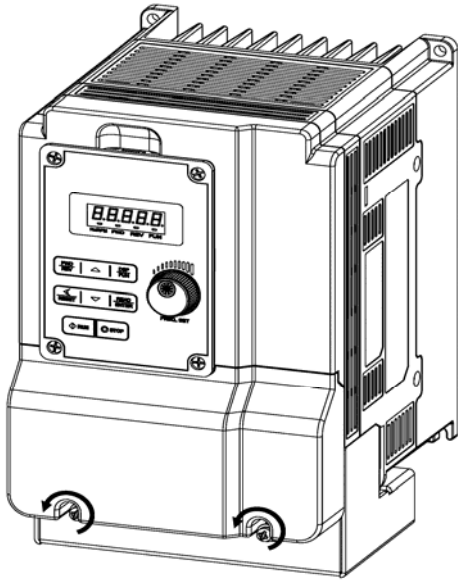

Step1 : Loosen the screws

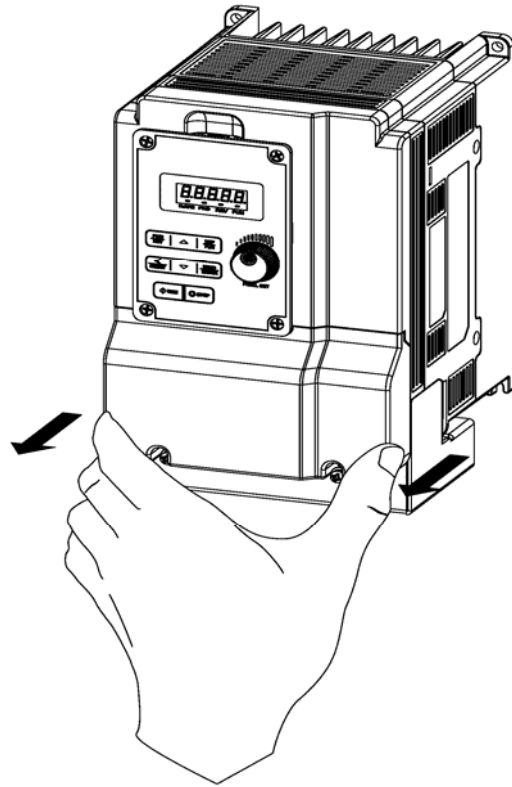

Step2 : Remove the terminal cover

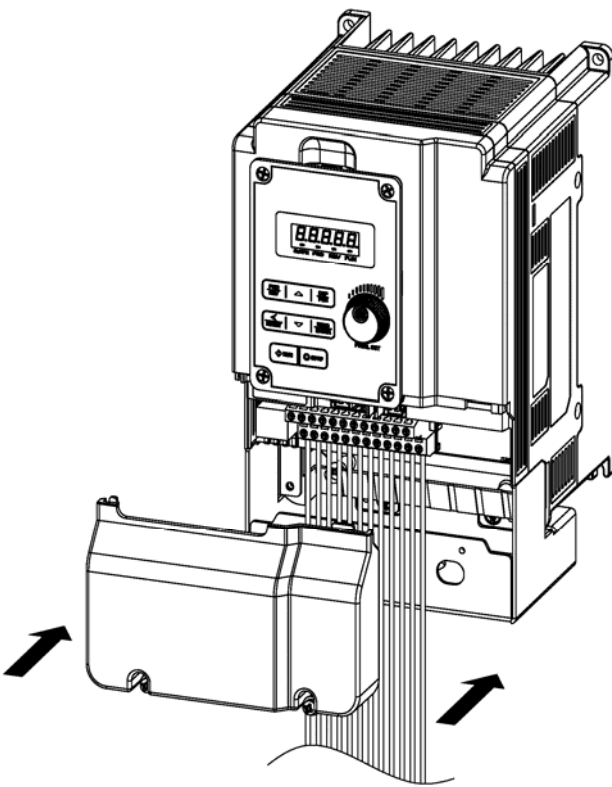

Step3 : Wire & Re-install the cover

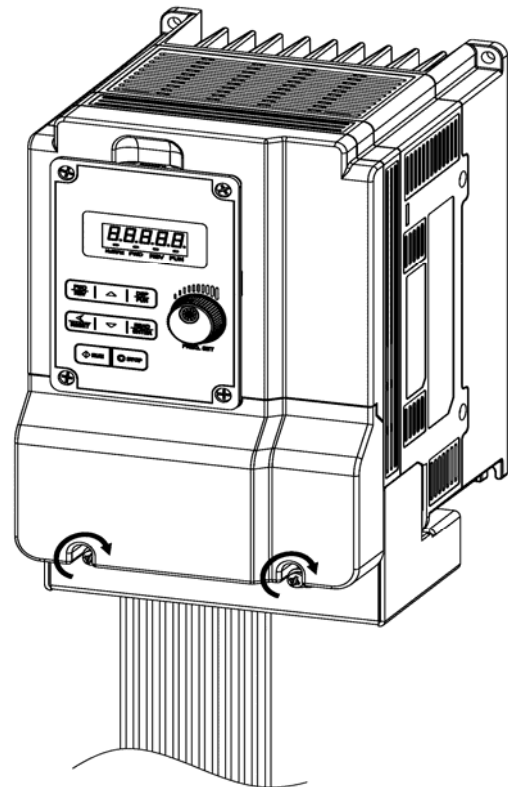

Step4 : Tighten the screws

(c) 200V 25HP / 400V 30HP

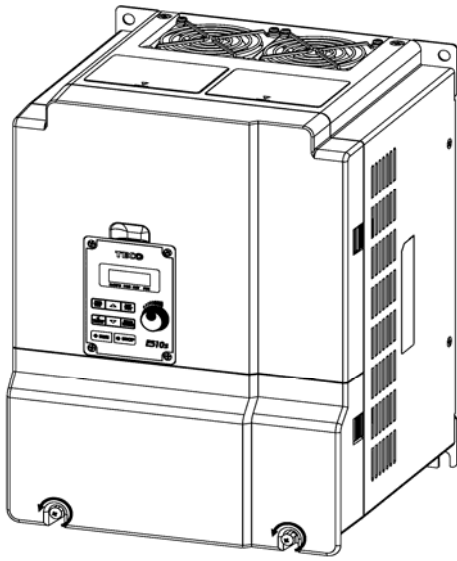

Step1: Loosen the screws

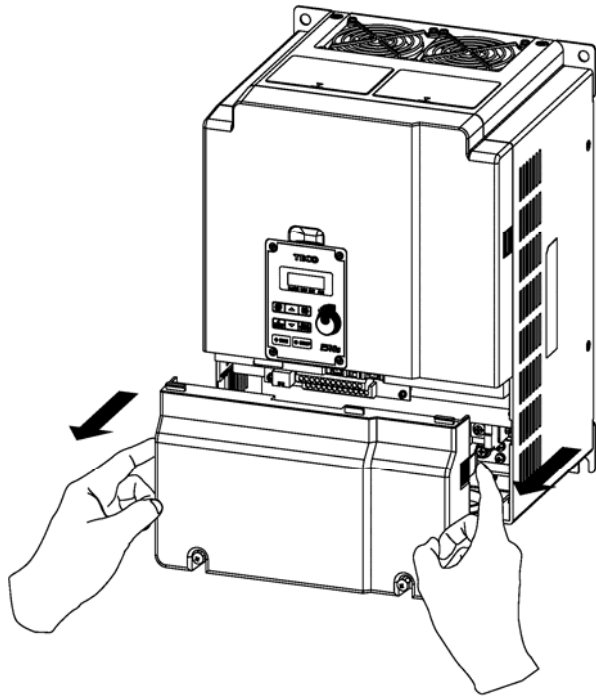

Step2: Remove the terminal cover

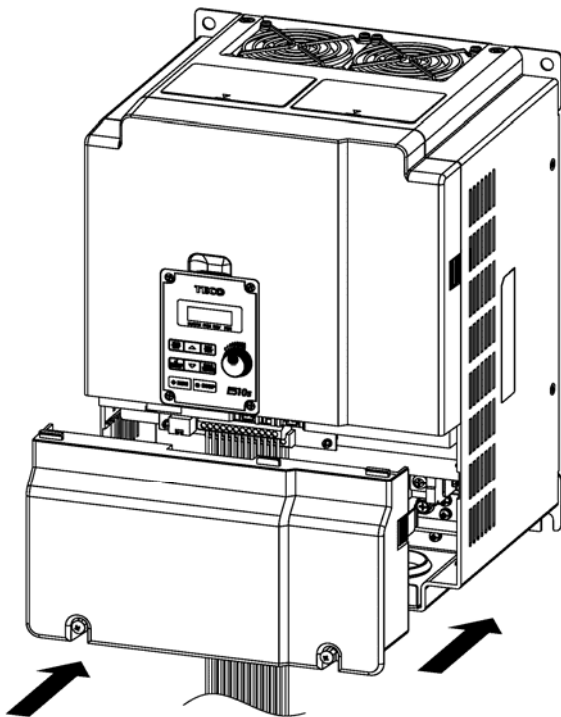

Step3 : Wire&Re-install the cover

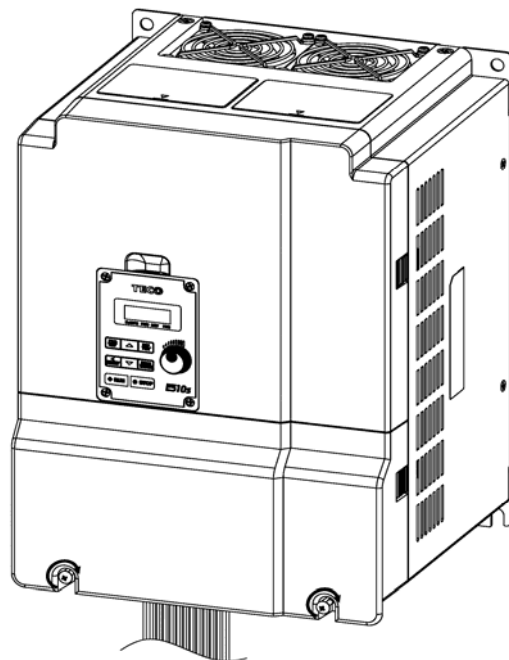

Step4 : Tighten the screws

(d) 200V 30HP~40HP / 400V 40HP~75HP

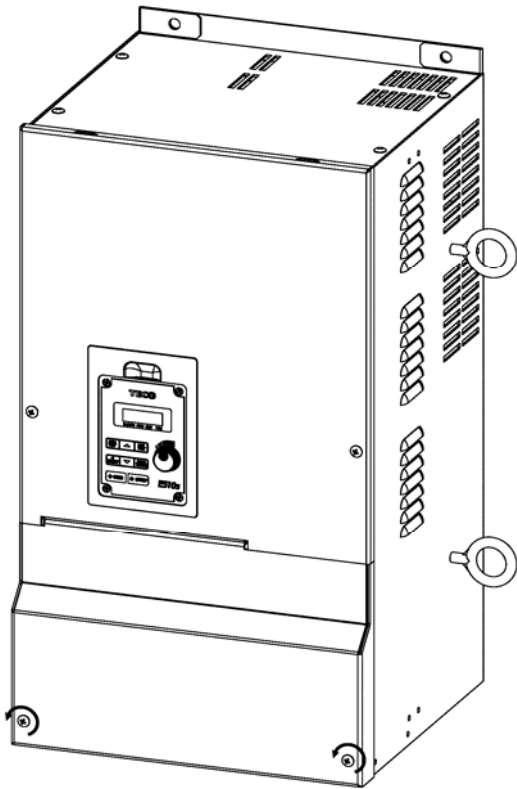

Step1: Loosen the screws

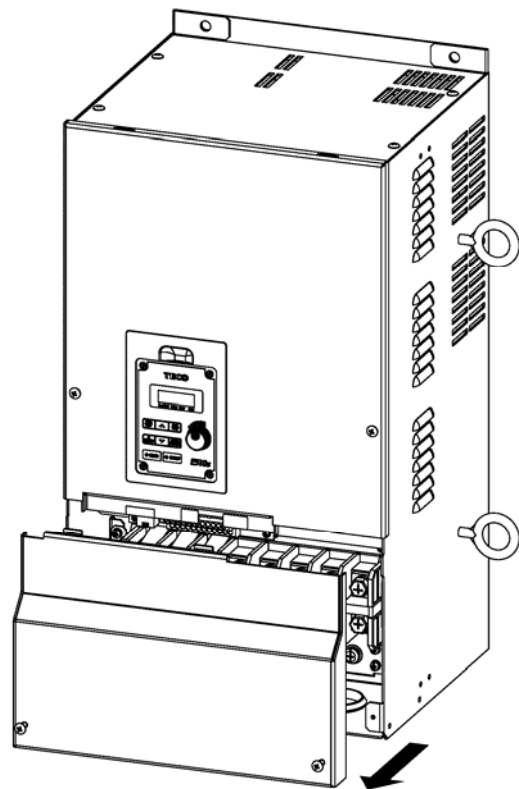

Step2: Remove the terminal cover

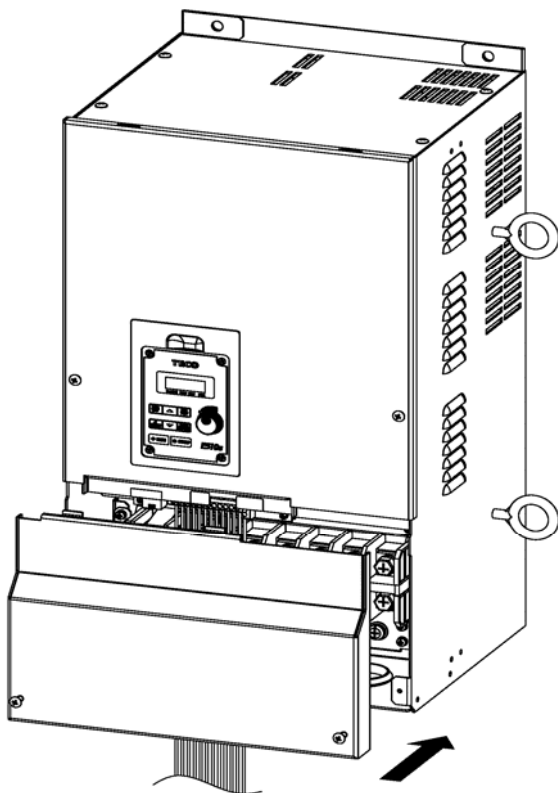

Step3 : Wirie&Re-install the cover

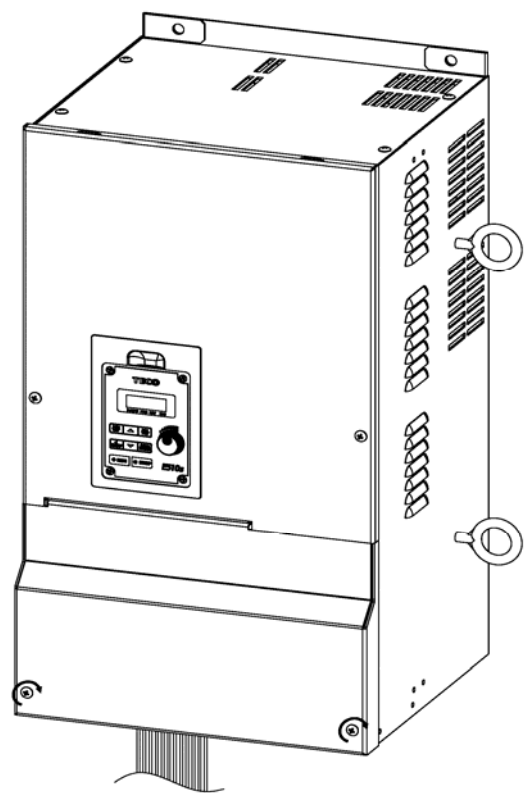

Step4 : Tighten the screws

(e) 400V 20HP~75HP(with EMC filter)

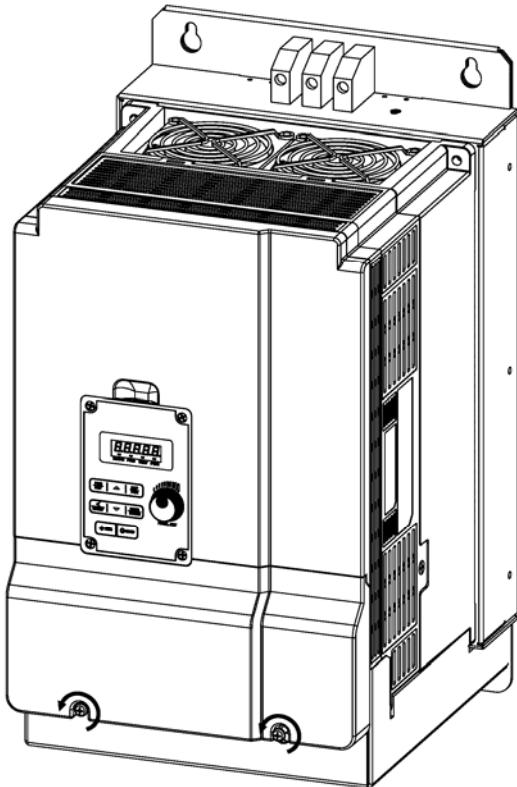

Step1: Loosen the screws

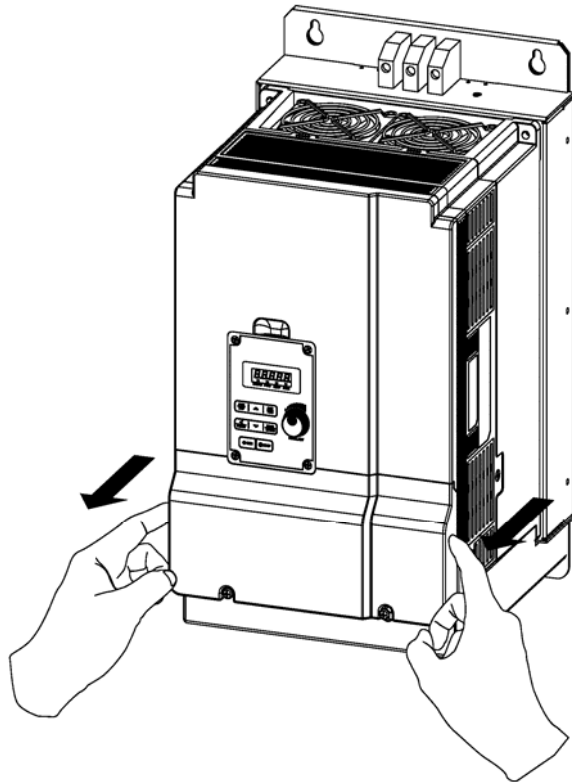

Step2: Remove the terminal cover

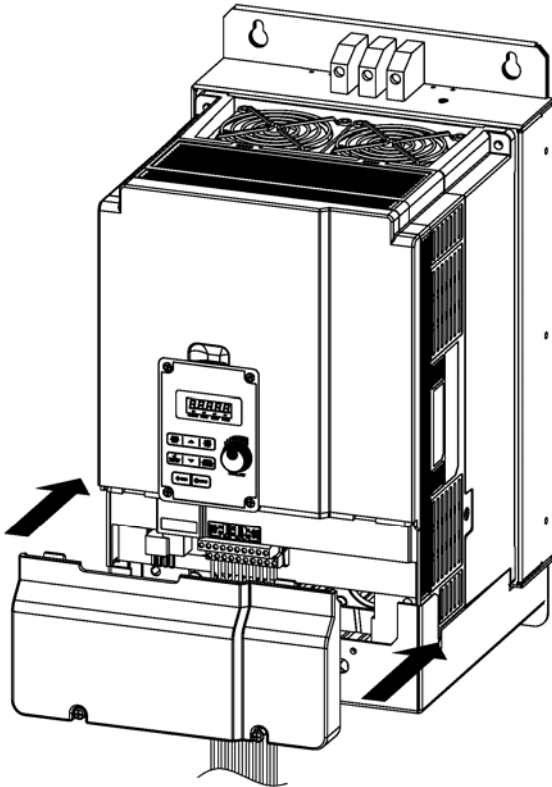

Step3 : Wirie&Re-install the cover

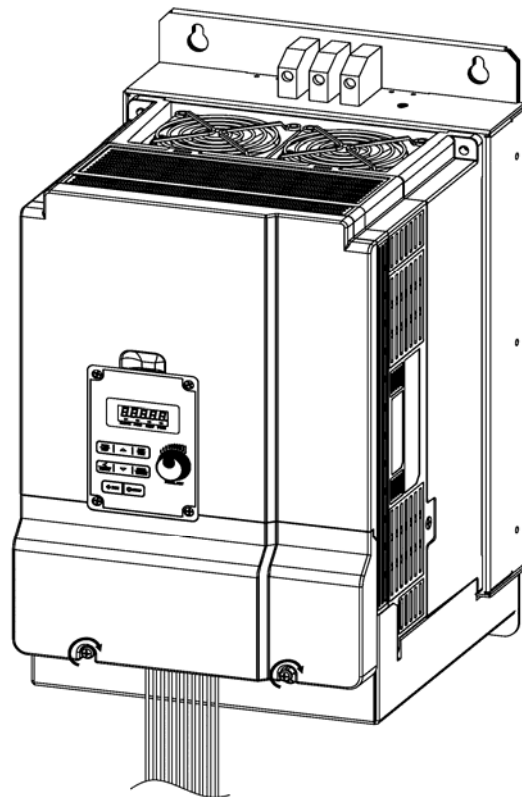

Step4 : Tighten the screws

3.2.2 Installation space

Provide sufficient air circulation space for cooling as shown in examples below.

Install the Inverter on surfaces that provide good heat dissipation .

Frame1 models : 2P5/201/202(three phase)/401/402

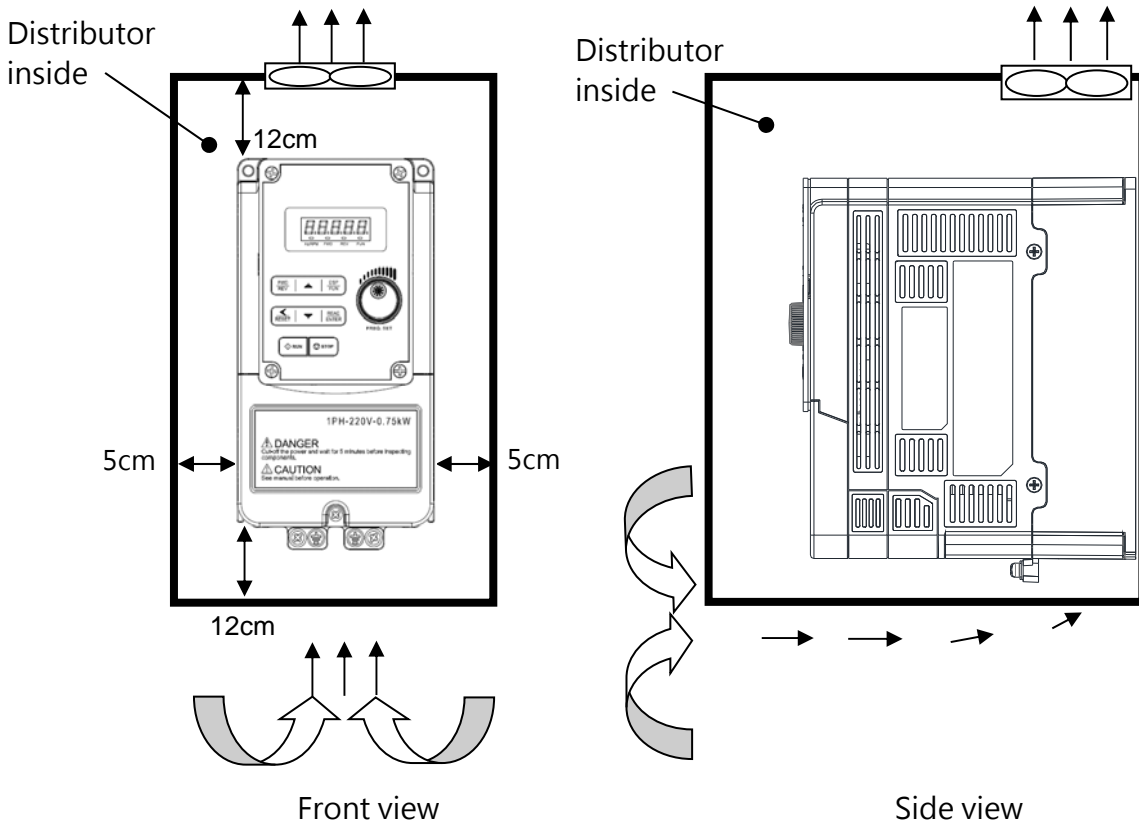

Side by side installation :

Provide the necessary physical space and cooling based on the ambient temperature and the heat loss in the panel.(2P5/201/202/401/402)

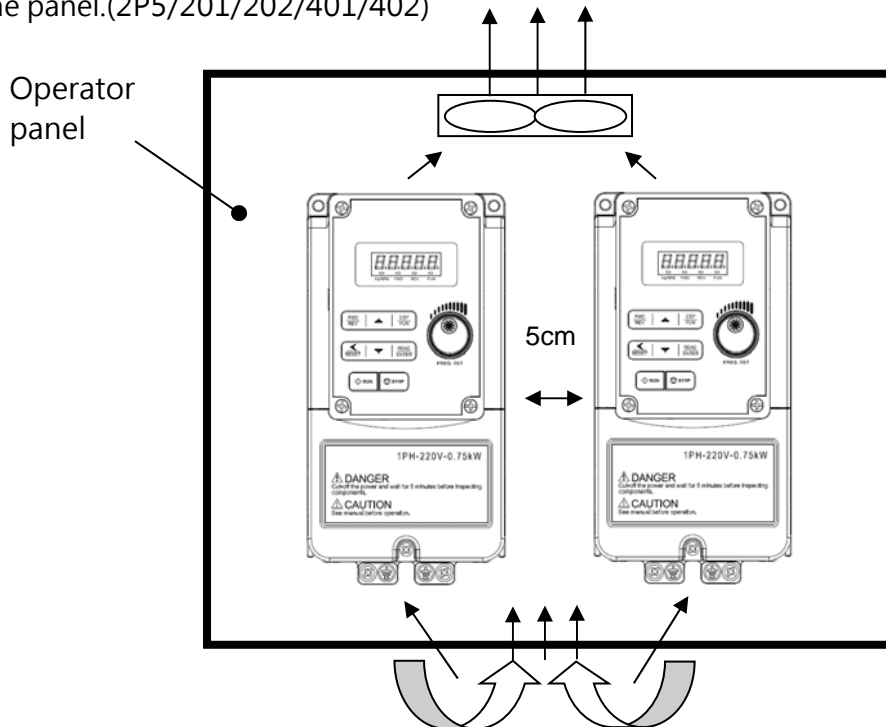

Note :  means "cooling fan" .

3.2.3 External View

3.2.3.1 IP20/NEMA 1

(a) 200V 0.5HP~1HP / 400V 1HP~2HP / 200V 2HP(3PH)

- IP20

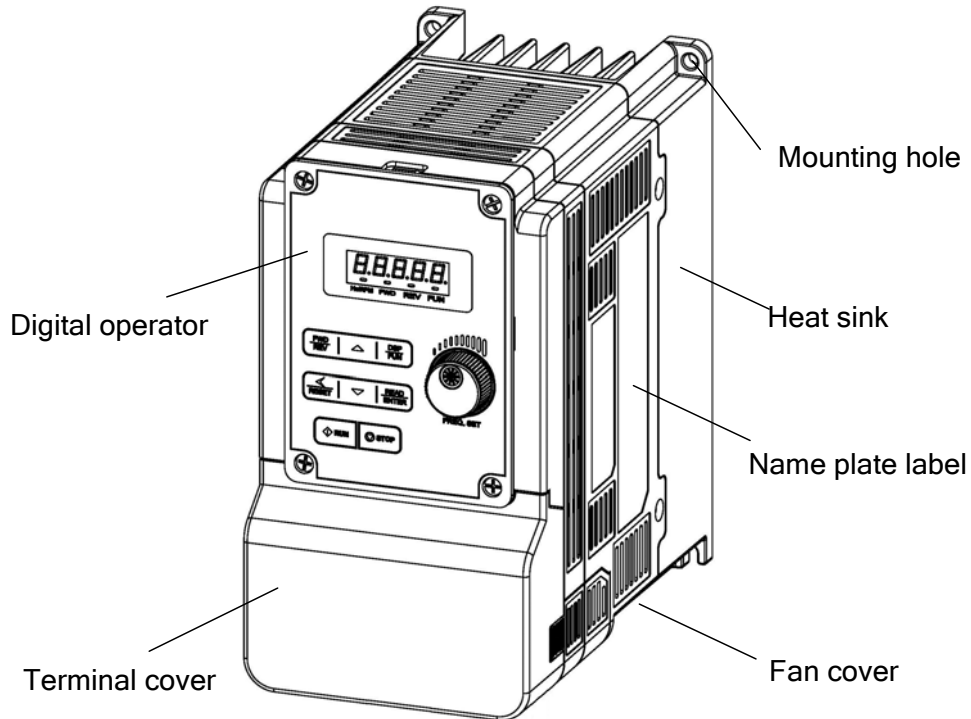

- NEMA1

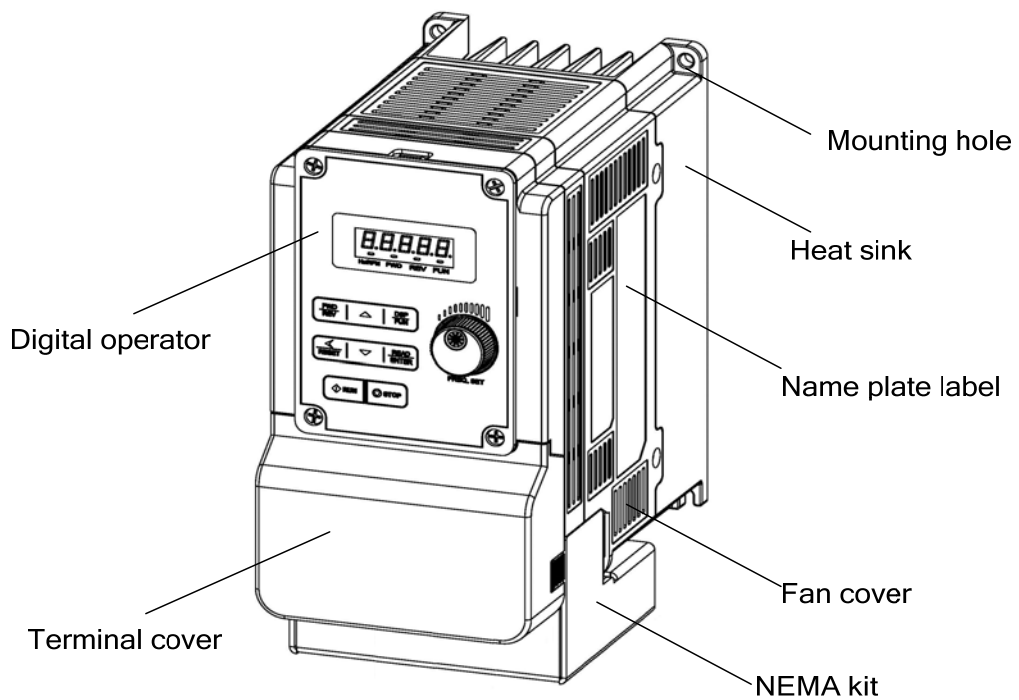

(b) 200V 2HP(1/3PH) / 200V 3HP~20HP / 400V 3HP~25HP

▪ IP20

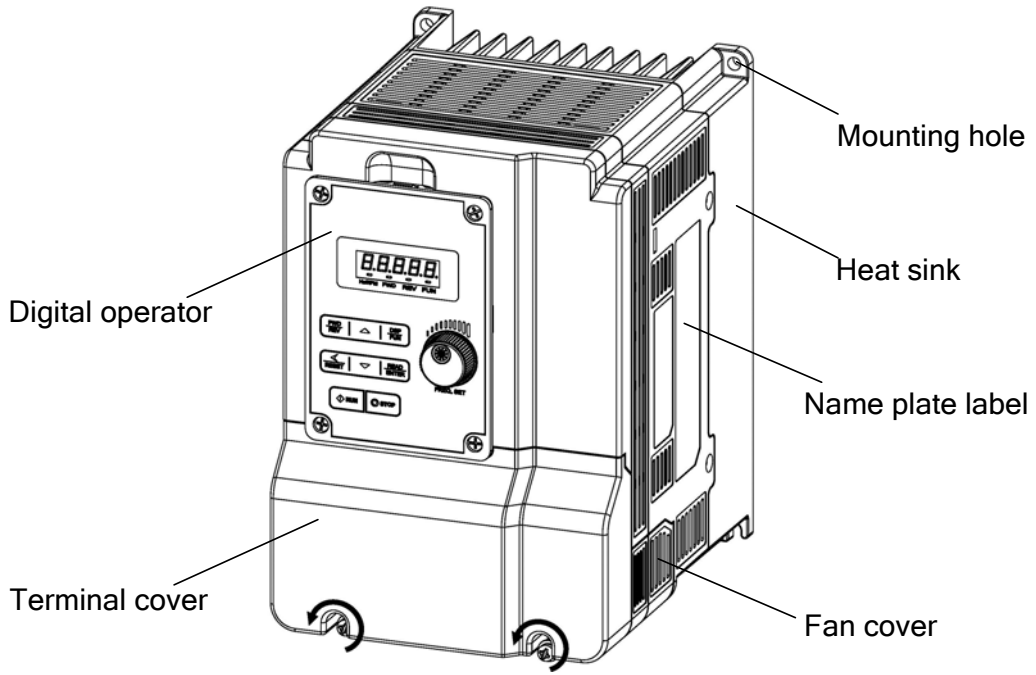

▪ NEMA1

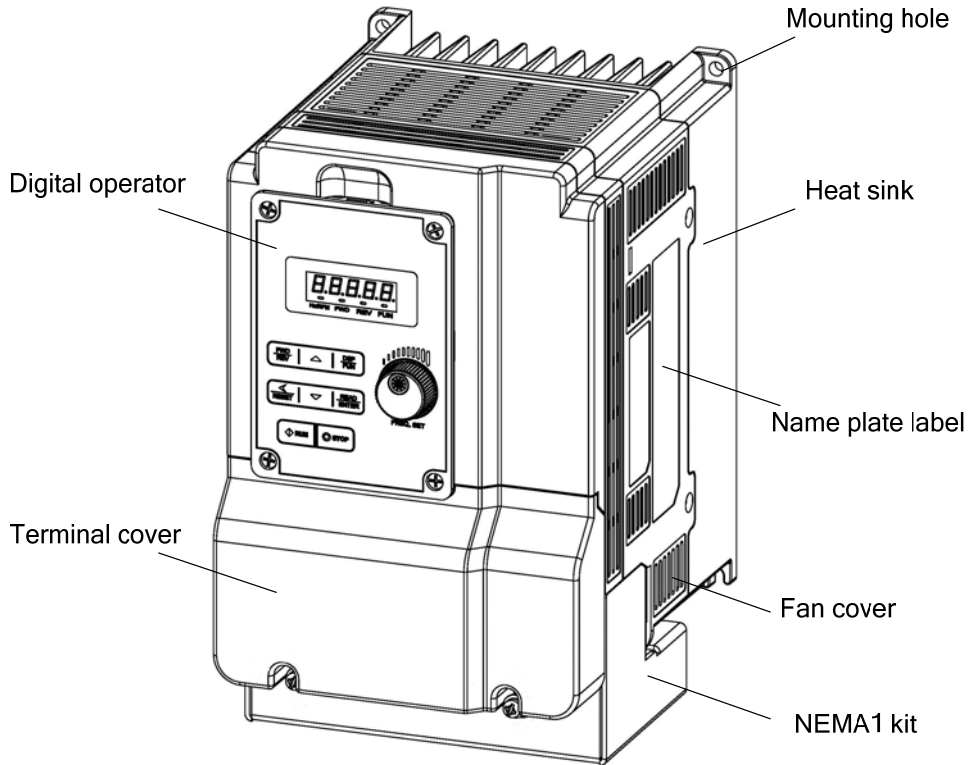

(c) 200V 25HP / 400V 30HP

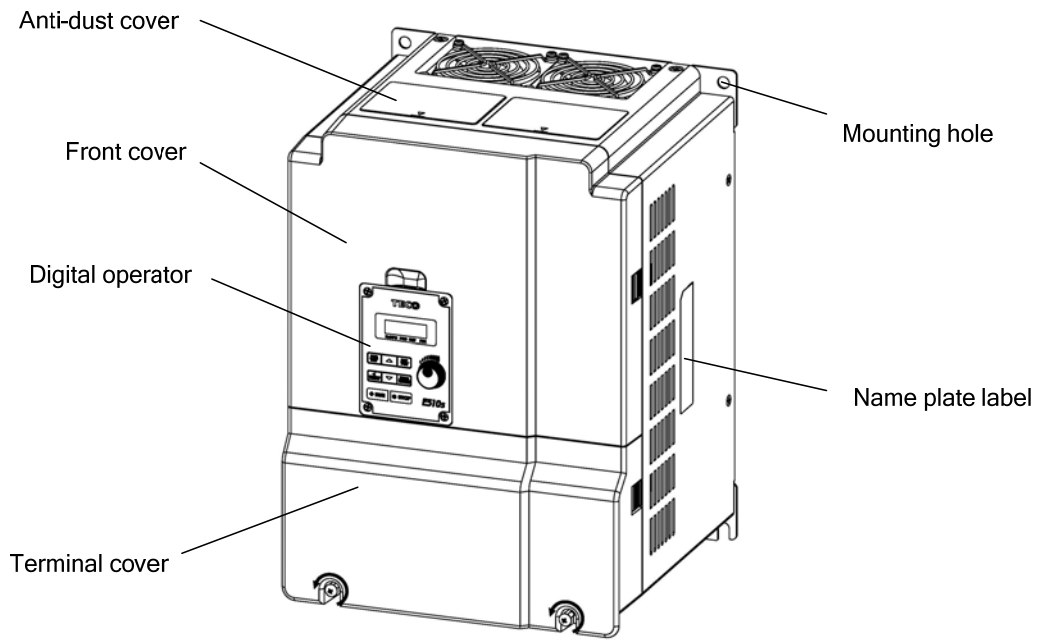

(d) 200V 30HP~40HP / 400V 40HP~75HP

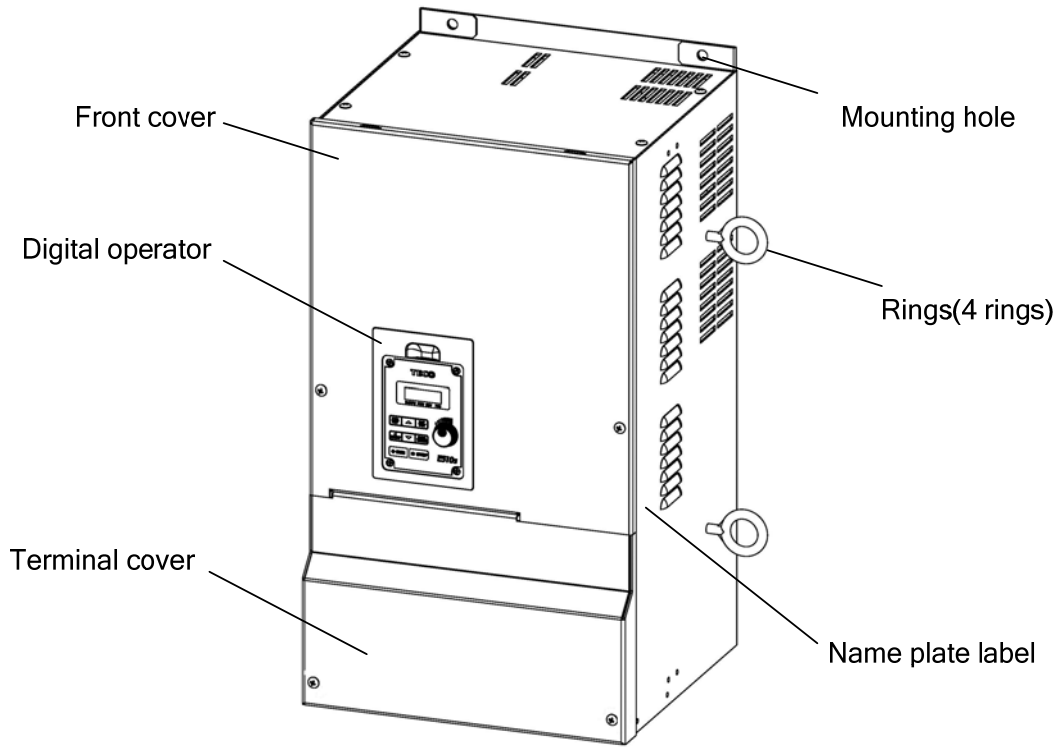

▪ Interior layout

(a) 200V 0.5HP~1HP / 400V 1HP~2HP / 200V 2HP(three phase)

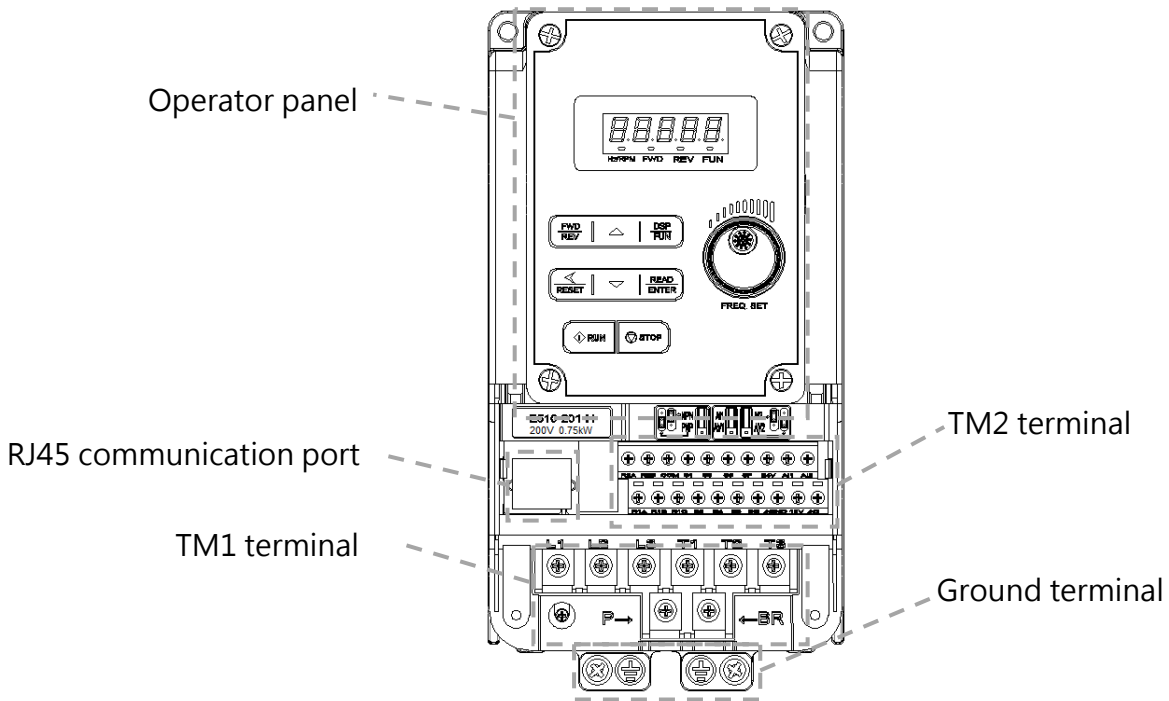

(b) 200V 2HP(single/three) / 200V 3HP~20HP / 400V 3HP~25HP

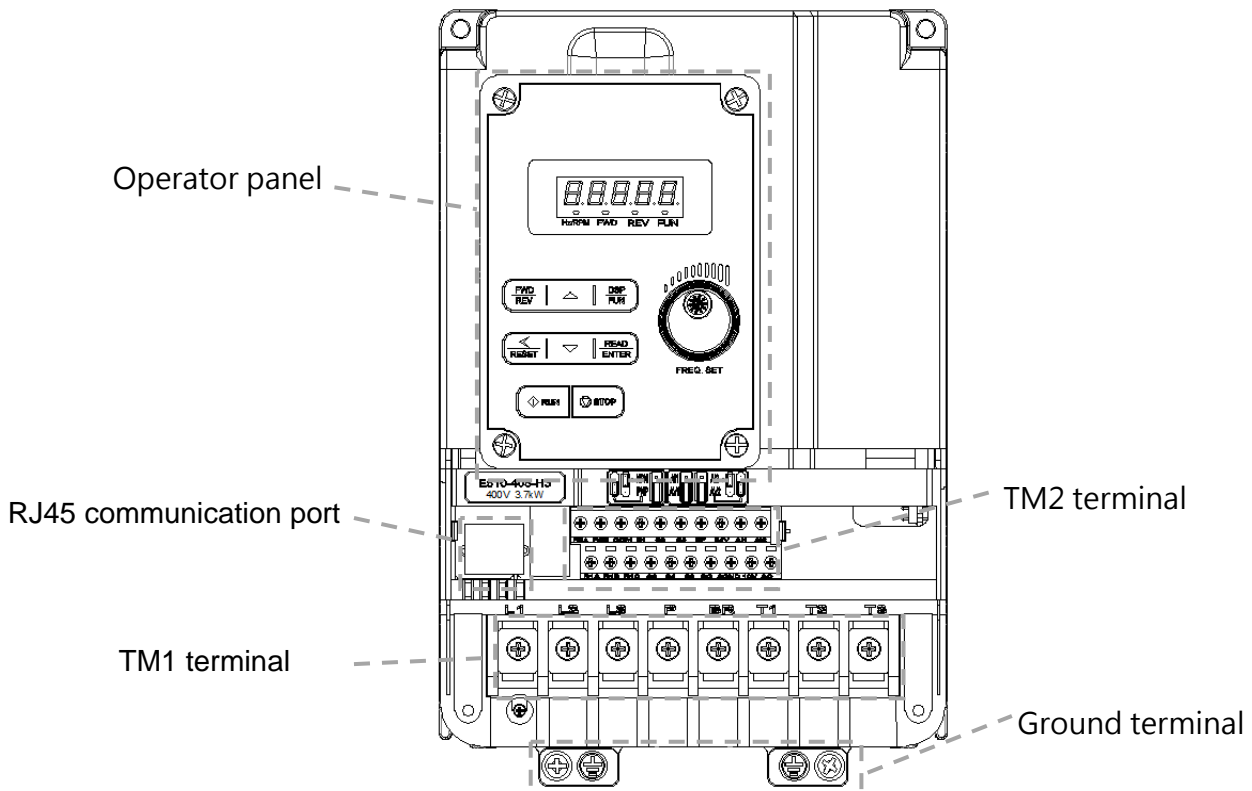

(c) 200V 25HP / 400V 30HP

(d) 200V 30HP~40HP / 400V 40HP~75HP

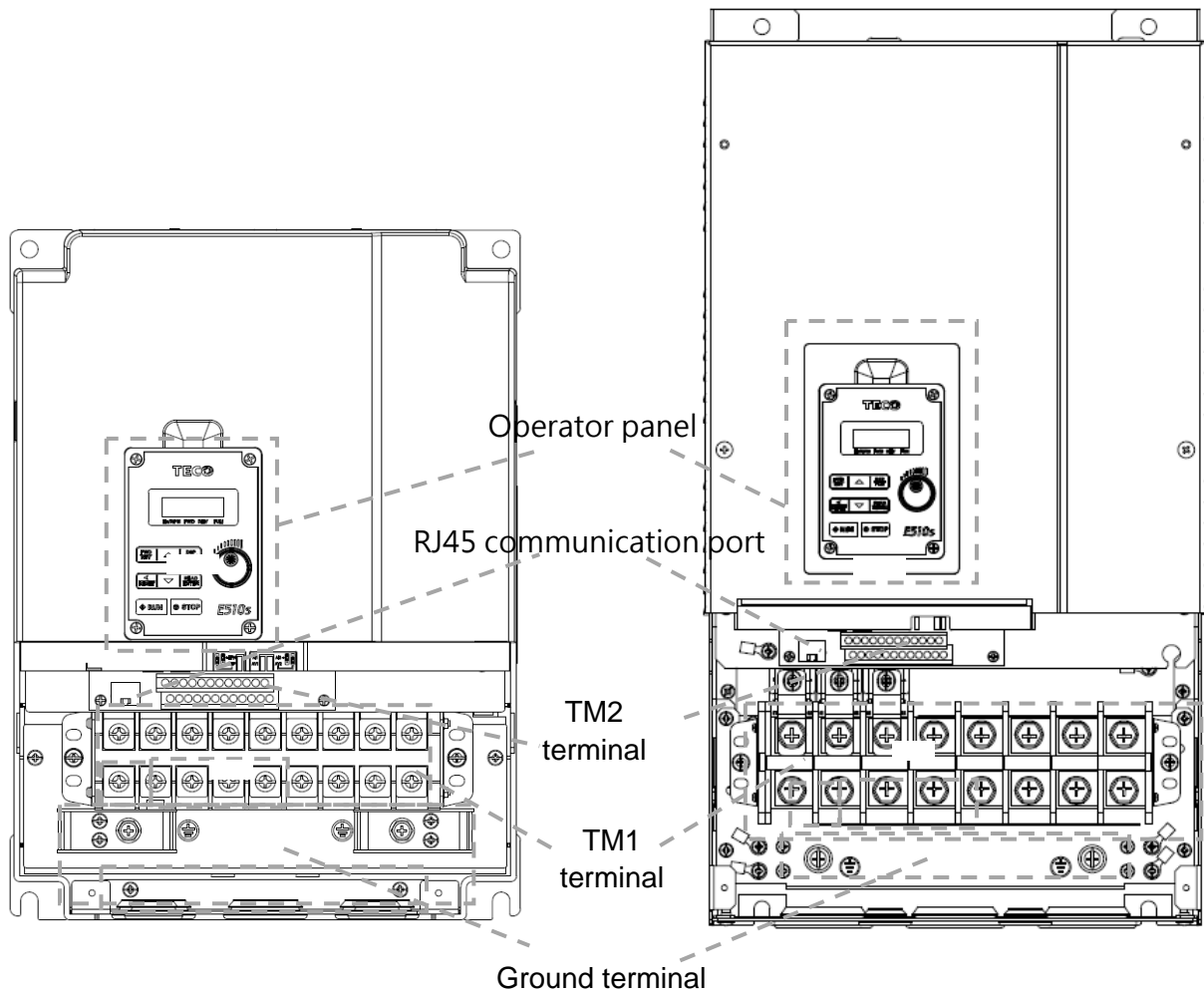

▪ Warning label

(a) 200V 0.5HP~20HP / 400V 1HP~25HP

	WARNING / AVERTISSEMENT
	Risk of electrical shock. Shut off main power and wait for 5 minutes before servicing. Risque de choc électrique. Coupez l'alimentation principale et attendez 5 minutes avant l'entretien.
	Hot surface. Risk of burn. / Surface chaude. Risque de brûlure.
	CAUTION / ATTENTION
	See manual before operation. / Consultez le manuel avant l'opération.

(b) 200V 25HP~40HP / 400V 30HP~75HP

	WARNING / AVERTISSEMENT
	Risk of electrical shock. Shut off main power and wait for 15 minutes before servicing. Risque de choc électrique. Coupez l'alimentation principale et attendez 15 minutes avant l'entretien.
	CAUTION / ATTENTION
	See manual before operation. / Consultez le manuel avant l'opération.

3.3 Wiring Guidelines

3.3.1. Power cables :

- L1(L) 、L2 、L3(N) for three phase input models.
- L1(L) and L3(N) for single phase input models. (L2 terminal will be removed)
- Motor cable must be connected T1, T2, T3 of TM1 terminals.

Power cables should be selected by the following conditions :

- Only can use copper wires, and the diameter needs to use 105 degrees Celsius level.
- The minimum power cable rated voltage level of 240V system is 300V.
- For the safety, power cables should be connected by "O" type terminal.

Warning

Connection of supply line cable to terminals T1,T2, T3 will result in serious damage to the drive components. Power cables should be separated with the other high voltage and high current cables to prevent the noise interference, please refer the photo below :

- Inverter with dedicated power line

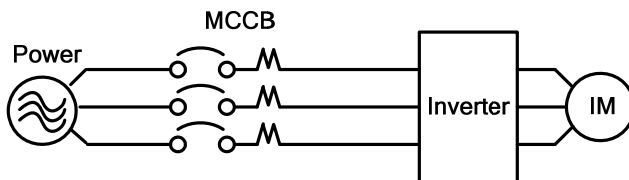

- Install a supply RFI filter or Isolation transformer when the power source is shared with other high power electrical equipment as shown below

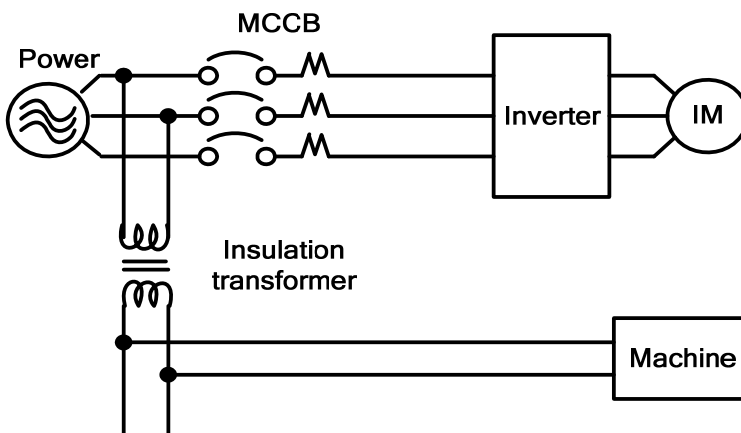
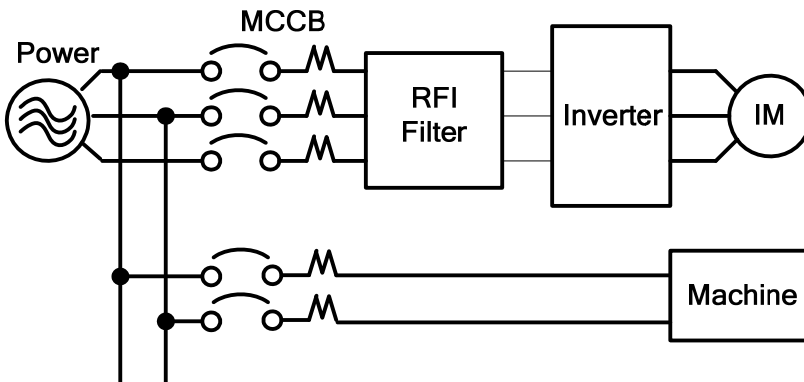

3.3.2 Control cable selection and wiring

Control cables should be connected to terminal block TM2, Choose power & Control cables according to the following criteria :

- Use copper wires with correct diameter and temperature rating of 65/70°C
- Minimum cable voltage rating for 200V type inverters should be 300VAC. Minimum cable voltage rating for 400V type inverters should be 600VAC
- Route all cables away from other high voltage or high current power lines to reduce interference effects °
- Use a twisted pair shielded cable and connect the shield (screen) wire to the ground terminal at the inverter end only. Cable length should not exceed 50 meters

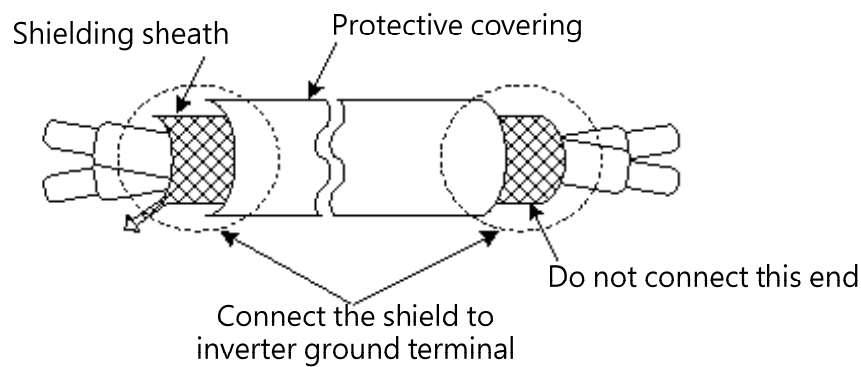

3.3.3. Wiring and EMC guidelines

- For effective interference suppression, do not route power and control cables in the same conduit or trunking
- To prevent radiated noise, motor cable should be put in a metal Conduit. Alternatively an armored or shielded type motor cable should be used
- Motor cable and signal lines of other control equipment should be at the least 30 cm apart
- For effective suppression of noise emissions the cable armor or shield must be grounded at both ends to the motor and the inverter ground. These connections should be as short as possible

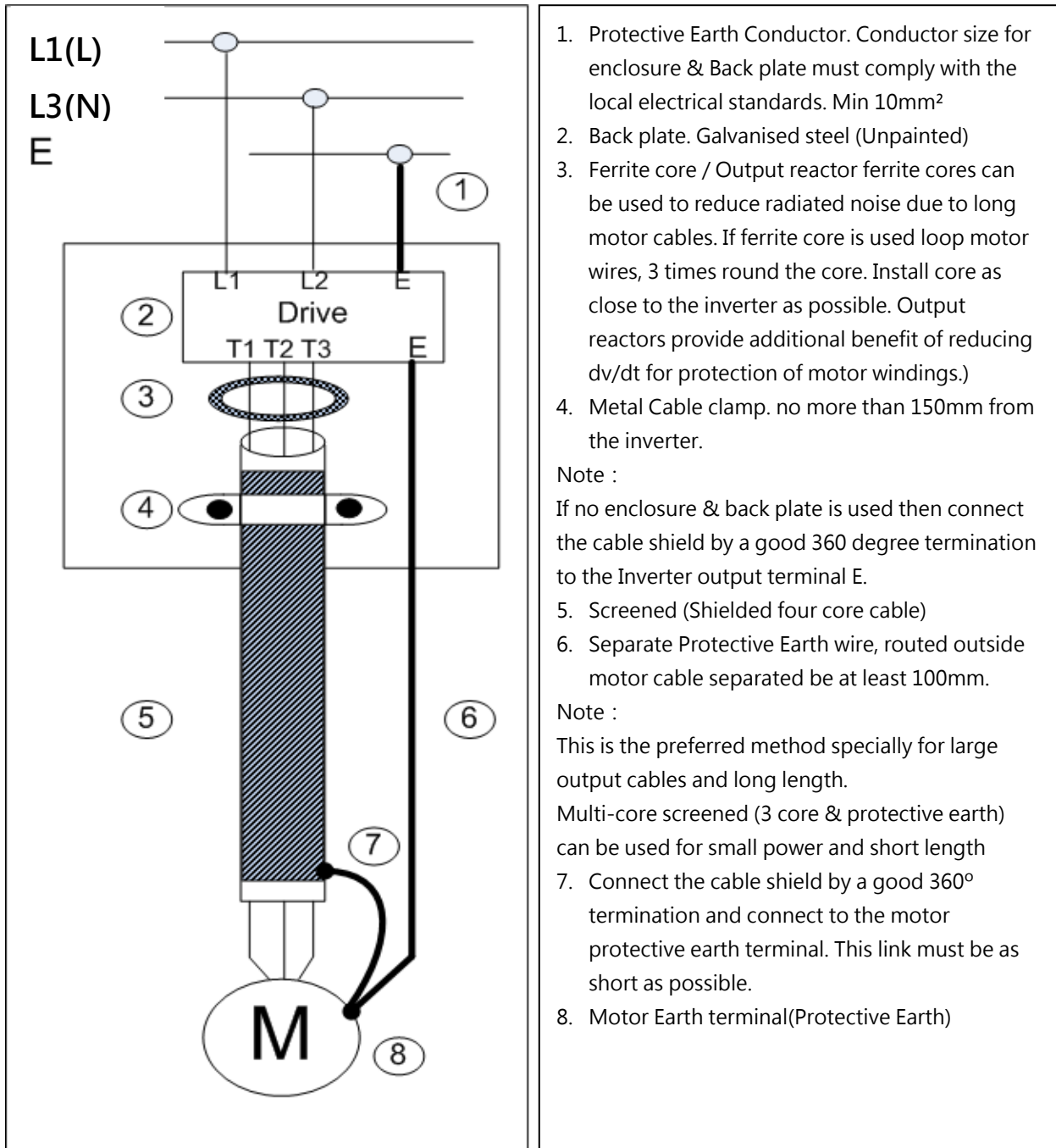

1. Protective Earth Conductor. Conductor size for enclosure & Back plate must comply with the local electrical standards. Min 10mm²
2. Back plate. Galvanised steel (Unpainted)
3. Ferrite core / Output reactor ferrite cores can be used to reduce radiated noise due to long motor cables. If ferrite core is used loop motor wires, 3 times round the core. Install core as close to the inverter as possible. Output reactors provide additional benefit of reducing dv/dt for protection of motor windings.)
4. Metal Cable clamp. no more than 150mm from the inverter.

Note :

If no enclosure & back plate is used then connect the cable shield by a good 360 degree termination to the Inverter output terminal E.

5. Screened (Shielded four core cable)
6. Separate Protective Earth wire, routed outside motor cable separated be at least 100mm.

Note :

This is the preferred method specially for large output cables and long length.

Multi-core screened (3 core & protective earth) can be used for small power and short length

7. Connect the cable shield by a good 360° termination and connect to the motor protective earth terminal. This link must be as short as possible.















8. Motor Earth terminal(Protective Earth)

3.3.4. Failure liability

Teco bears no responsibility for any failures or damaged caused to the inverter if the recommendations in this instruction manual have not been followed specifically points listed below :

- If a correctly rated Fuse or Circuit breaker has not been installed between the power source and the inverter.
- If a magnetic contactor, a phase capacitor, burst absorber and LC or RC circuits have been connected between the inverter and the motor.
- If an incorrectly rated three-phase squirrel cage induction motor has been used
- When one inverter is driving several motors, the total current of all motors running simultaneously must be less than the rated current of the inverter, and each motor has to be equipped with a correctly rated thermal overload relay.
- “Only Intended For Use In A Pollution Degree 2 Environment” or equivalent.
- Since there is no over speed protection there will be no liability due to overspeed damage.

3.3.5 Considerations for peripheral equipment

	→	Power	Ensure that the supply voltage is correct. A molded-case circuit breaker or fused disconnect must be installed between the AC source and the inverter
	→	Circuit Breaker & RCD	Use a molded-case circuit breaker that conforms to the rated voltage and current of the inverter. Do not use the circuit breaker as the run/stop switch for the inverter.
	→		Residual Current Circuit Breaker(RCD) Current setting should be 200mA or above and the operating time at 0.1 second or longer to prevent malfunctions.
	→	Magnetic contactor	Normally a magnetic contactor is not needed. A contactor can be used to perform functions such as external control and auto restart after power failure. Do not use the magnetic contactor as the run/stop switch of the inverter.
	→	AC reactor for power quality improvement	When a 200V/400V inverter with rating below 15KW is connected to a high capacity power source (600KVA or above) then an AC reactor can be connected for power factor improvement and reducing harmonics.
	→	Input noise filter	E510s has a built-in filter (Class A/First Environment Category C2, except for Frame 4) To satisfy the required EMC regulations for your specific application you may require an additional EMC filter.
	→	Inverter	Connect the single phase power to Terminals, L1(L) & L3(N). Warning! Connecting the input terminals T1, T2, and T3 to AC input power will damage the inverter. Output terminals T1, T2, and T3 are connected to U, V, and W terminals of the motor. To reverse the motor rotation direction just swap any two wires at terminals T1, T2, and T3. Ground the Inverter and motor correctly. Ground Resistance for 200V have to less than 100 Ohms. Ground Resistance for 400V have to less than 10 Ohms
	→		
	→		
	→		
	→	Inverter	Connect the single phase power to Terminals, L1(L) & L3(N). Warning! Connecting the input terminals T1, T2, and T3 to AC input power will damage the inverter. Output terminals T1, T2, and T3 are connected to U, V, and W terminals of the motor. To reverse the motor rotation direction just swap any two wires at terminals T1, T2, and T3. Ground the Inverter and motor correctly. Ground Resistance for 200V have to less than 100 Ohms. Ground Resistance for 400V have to less than 10 Ohms
	→		
	→		
	→	Motor	Three-phase induction motor. Voltage drop on motor due to long cable can be calculated, volts drop should be less than 10%. The formula of Phase-to-phase voltage drop is $(V) = \sqrt{3} \times \text{resistance of wire } (\Omega/\text{km}) \times \text{length of line(m)} \times \text{current} \times 10^{-3}$
	→		

3.3.6 Ground connection

Inverter ground terminal must be connected to installation ground correctly and according to the required local wiring regulations

- Ground cable size must be according to the required local wiring regulations. Ground connection should be as short as possible
- Do not share the ground of the inverter with other high current loads (Welding machine, high power motors). Ground each unit separately
- Ensure that all ground terminals and connections are secure
- Do not make ground loops when several inverters share a common ground point.

Please leave at least 5cm while installing inverter side by side in order to provide enough cooling space.

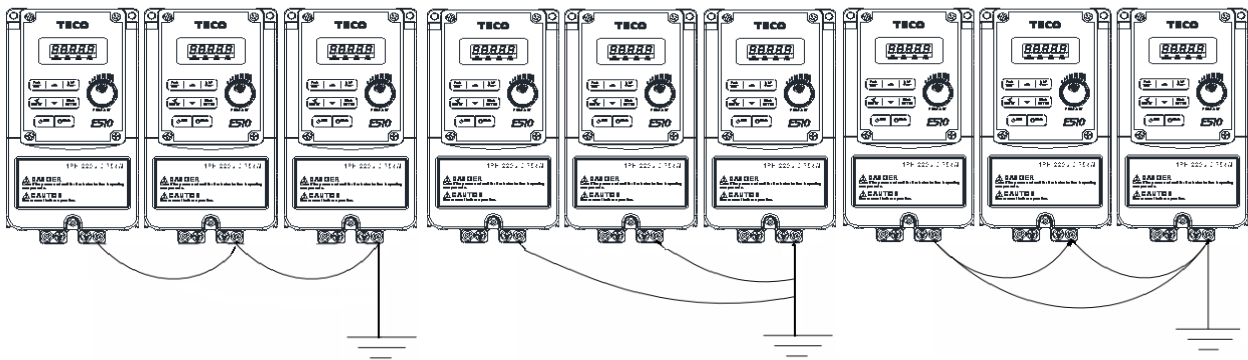

(a) Corrent

(b) Correct

(c) Incorrect

➤ Input power cable length

The length of the cables between the power source and/or the motor and inverter can casue a significant phase to phase voltage reduction due to the voltage drop across the cables. The maximum voltage drop is 2%, if this value is exceeded, a wire size having large diameter is needed. To calculate phase to phase voltage drop by the following formula.

Phase-to-phase voltage drop(V) =

$$\sqrt{3} \times \text{resistance of wire}(\Omega/\text{km}) \times \text{length of line}(\text{m}) \times \text{current (A)} \times 10^{-3}$$

➤ Installing an AC line reactor

If the inverter is connected to a large-capacity power source (600kVA or more), install an optional AC reactor on the input side of the inverte, it can improve the power factor on the power supply side.

➤ Cable length & Carrier frequency

The followable setting of the PWM carrier frequency is also determined by motor cable length and is specified in the following table.

Cable length of motor in m (ft.)	< 30m (100)	30m ~ 50m (100~165)	50m ~100m (166~328)	≥100m (329)
Recommanded carrier frequenc allowed parameter 11-01	16kHz(max)	10kHz(max)	5kHz(max)	2kHz(max)

※ The minimum carrier frequency of SLV control mode is 4K, please confirm the cable length.

3.3.7 Single / Multi Pump Dedicated Wiring Diagram

PUMP Wiring Diagram for Pressure Sensor of Voltage Type

Single Pump :

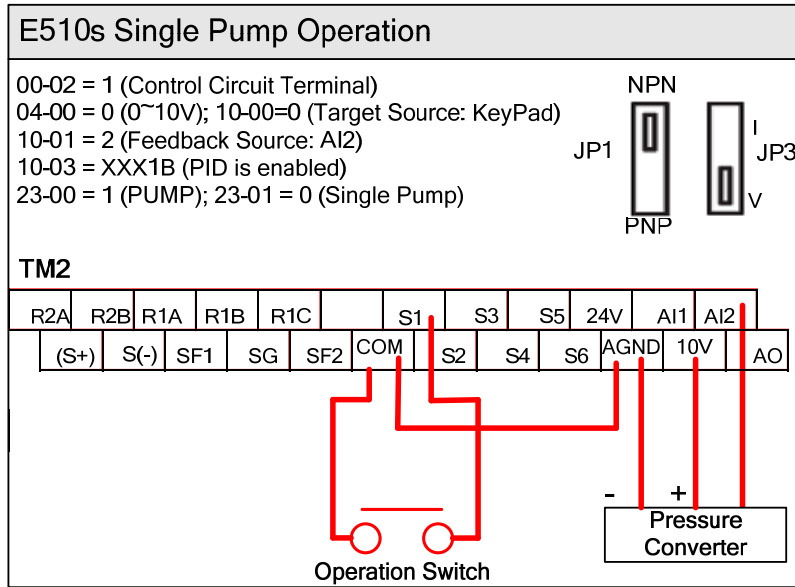

Multi-Pump :

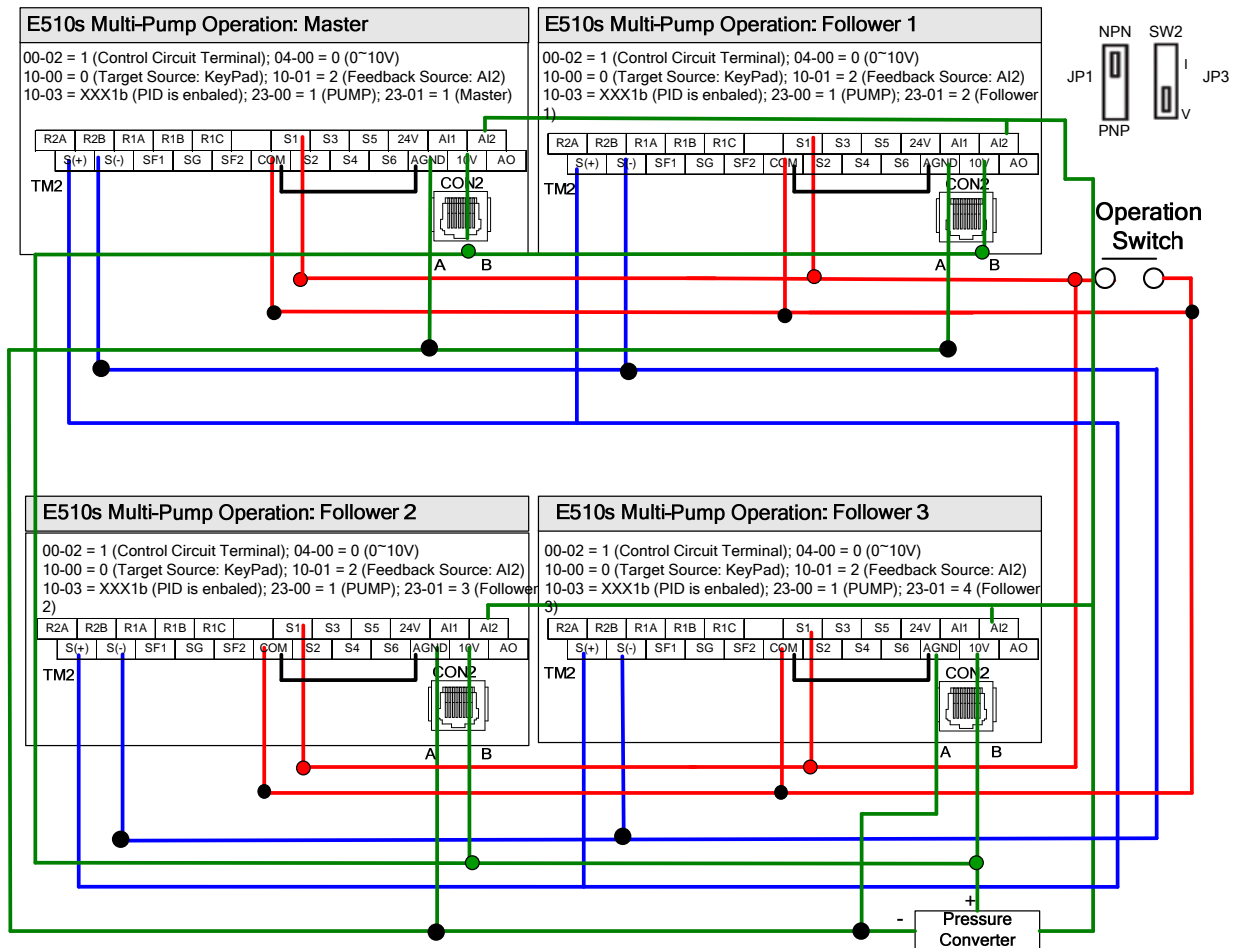

PUMP Wiring Diagram for PressureSensor of Current Type

Single Pump :

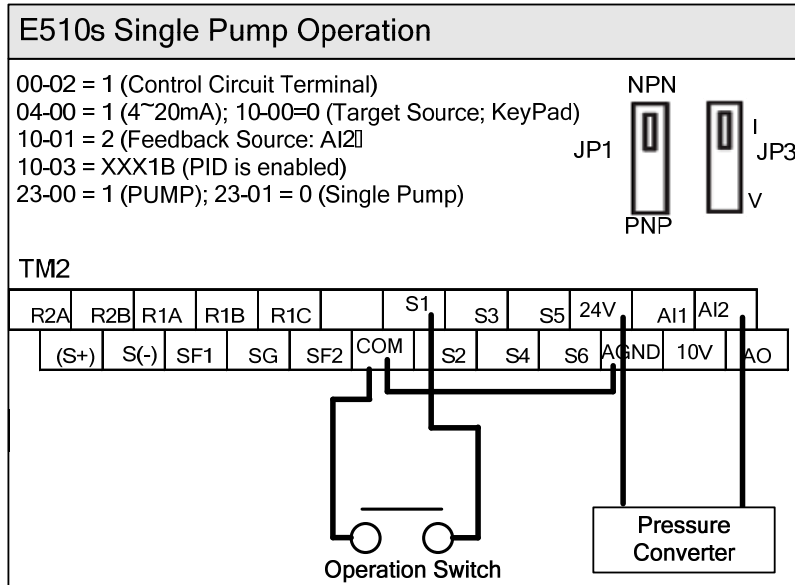

Multi-Pump :

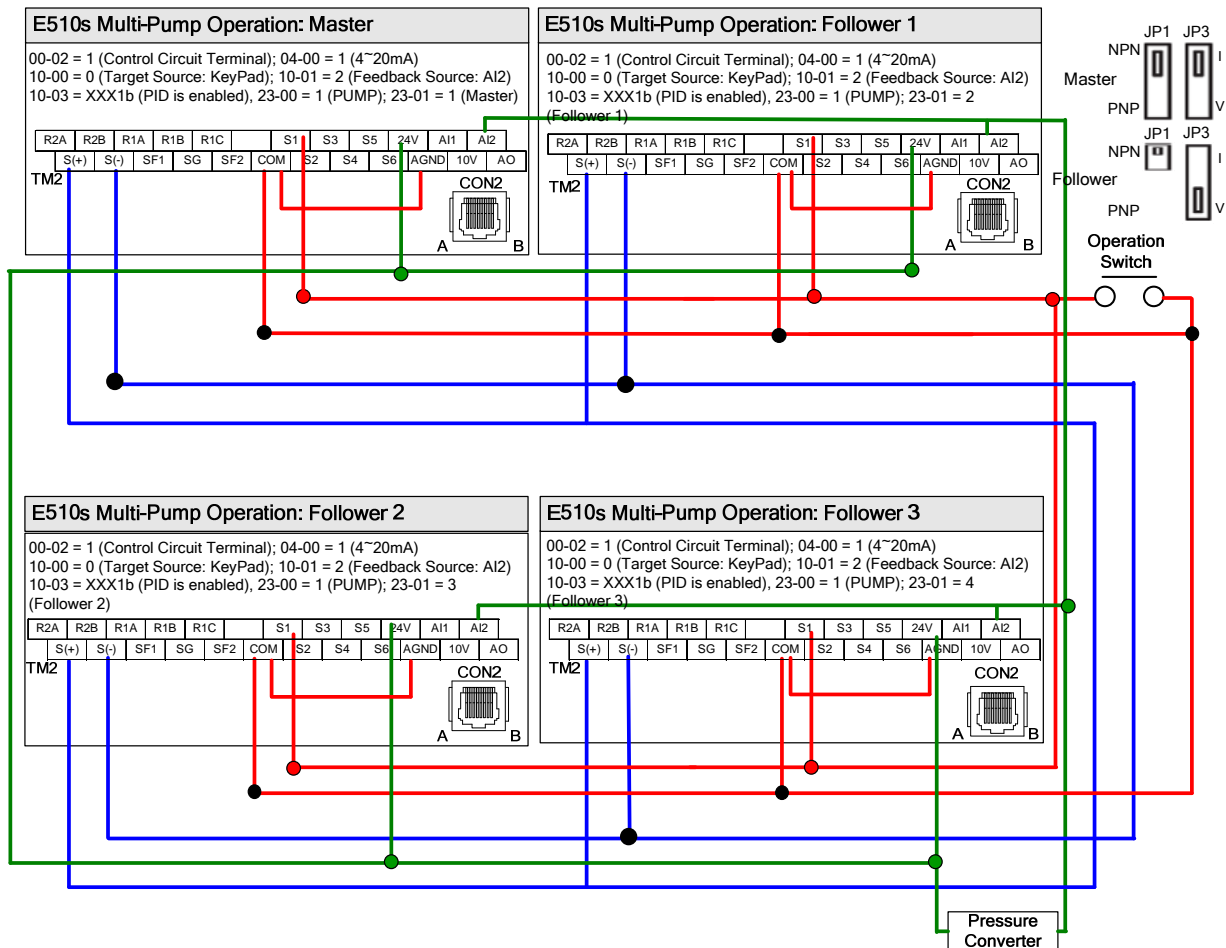

Notes1: The position of dip switch requires being correct (JP1,JP3), it is required to reconnect the power after setting Master/Slave.

Notes2: When the communication modes is selected to be multiple pumps in parallel connection (09-01=3), the baud rate settings 09-02 of Master and Slave are required to be consistent.

Notes3: Refer to parameter 23-31 for the actions in parallel connection modes.

Notes4: In the wiring of multi-pump current type pressure sensor, it is required to adjust Slave to be 04-07=252.0% and 04-08=-25.0%

Notes5: In multi-pump operation, if one of the inverter does not Power ON, the 24V of connection is also need to disconnect to avoid magneto-resistance effect.

3.4 Specifications

3.4.1 Product specifications

200V Class : Single phase

Model : E510-□□□-SH1F	2P5	201	202	203
Horse power (HP)	0.5	1	2	3
Suitable motor capacity (KW)	0.4	0.75	1.5	2.2
Rated output current (A)	3.1	4.5	7.5	10.5
Rated capacity (KVA)	1.2	1.7	2.90	4.00
Input voltage range(V)	Single phase : 200~240V, 50/60Hz			
Allowable voltage fluctuation	-15%~+10%			
Output voltage range(V)	Three phase : 0~240V			
Input current (A)*	8.5	12	16	23.9
Inverter net weight (KG)	1.5	1.5	2.0	2.0
Allowable momentary power loss time(s)	2.0	2.0	2.0	2.0
Enclosure	IP20/NEMA1			

200V Class : Single/Three phase

Model : E510-□□□-SH	2P5	201	202	203
Horse power (HP)	0.5	1	2	3
Suitable motor capacity (KW)	0.4	0.75	1.5	2.2
Rated output current (A)	3.1	4.5	7.5	10.5
Rated capacity (KVA)	1.2	1.7	2.90	4.00
Input voltage range(V)	Single/Three : 200~240V, 50/60Hz			
Allowable voltage fluctuation	-15%~+10%			
Output voltage range(V)	Three phase : 0~240V			
Input current (A)*	8.5/4.5	12/6.5	16/11	23.9/12.5
Inverter net weight (KG)	1.5	1.5	2.0	2.0
Allowable momentary power loss time(s)	2.0	2.0	2.0	2.0
Enclosure	IP20/NEMA1			

200V Class : Three phase

(If connected to single-phase input, the output current must not exceed 50% of the rated current)

Model : E510-□□□-SH3	202	205	208	210	215	220
Horse power (HP)	2	5	7.5	10	15	20
Suitable motor capacity (KW)	1.5	4	5.5	7.5	11	15
Rated output current (A)	7.5	17.5	26	35	48	64
Rated capacity (KVA)	2.9	6.7	9.9	13.3	20.6	27.4
Input voltage range(V)	Three phase : 200~240V, 50/60Hz					
Allowable voltage fluctuation	-15%~+10%					
Output voltage range(V)	Three phase : 0~240V					
Input current (A)*	11	20.5	33	42	57	70
Inverter net weight (KG)	1.5	2.0	6.0	6.0	10.0	10.0
Allowable momentary power loss time(s)	2.0	2.0	2.0	2.0	2.0	2.0
Enclosure	IP20/NEMA1					

Model : E510-□□□-SH3	225	230	240
Horse power (HP)	25	30	40
HD/ND Suitable motor capacity (kW)	18.5/22	22/30	30/37
HD/ND Rated output current (A)	73/80	85/110	115/138
HD/ND Rated capacity (KVA)	27.8/30.1	32.4/41.9	43.8/52.6
Input voltage range(V)	Three phase : 200~240V,50/60Hz		
Allowable voltage fluctuation	-15%~+10%		
Output voltage range(V)	Three phase : 0~240V		
Input current (A)*	79.4/85.9	92.4/119.6	125/150
Inverter net weight (KG)	10.0	23.2	23.2
Allowable momentary power loss time(s)	2.0	2.0	2.0
Enclosure	IP20/NEMA1		

400V Class : Three phase

Model : E510-□□□-SH3(F)	401	402	403	405
Horse power (HP)	1	2	3	5
Suitable motor capacity (KW)	0.75	1.5	2.2	4.0
Rated output current (A)	2.5	3.8	5.3	9.2
Rated capacity (KVA)	1.7	2.9	4.0	6.7
Input voltage range(V)	Three phase : 380~480V,50/60Hz			
Allowable voltage fluctuation	-15%~+10%			
Output voltage range(V)	Three phase : 0~480V			
Input current (A)*	4.2	5.6	7.3	11.6
Inverter net weight (KG)	1.5	1.5	2.0	2.0
Inverter net weight(with Filter) (KG)	1.58	1.58	2.2	2.2
Allowable momentary power loss time(s)	2.0	2.0	2.0	2.0
Enclosure	IP20/NEMA1			

Model : E510-□□□-SH3(F)	408	410	415	420	425
Horse power (HP)	7.5	10	15	20	25
Suitable motor capacity (KW)	5.5	7.5	11	15	18.5
Rated output current (A)	13.0	17.5	24	32	40
Rated capacity (KVA)	9.9	13.3	19.1	24	30.5
Input voltage range(V)	Three phase : 380~480V,50/60Hz				
Allowable voltage fluctuation	-15%~+10%				
Output voltage range(V)	Three phase : 0~480V				
Input current (A)*	17	23	31	38	48
Inverter net weight (KG)	6.0	6.0	6.0	10.0	10.0
Inverter net weight(with Filter) (KG)	6.5	6.5	18.0	18.0	22.0
Allowable momentary power loss time(s)	2.0	2.0	2.0	2.0	2.0
Enclosure	IP20/NEMA1				

Model : E510-□□□ - SH3(F)	430	440
Horse power (HP)	30	40
HD/ND Suitable motor capacity (kW)	22/30	30/37
HD/ND Rated output current (A)	45/58	60/73
HD/ND Rated capacity (KVA)	34.3/44.2	45.7/55.6
Input voltage range(V)	Three phase : 380~480V,50/60Hz	
Allowable voltage fluctuation	+ 10% - 15%	
Output voltage range(V)	Three phase : 0~480V	
Input current (A)*	48.9/63	65.2/78.3
Inverter net weight (KG)	10.0	23.2
Inverter net weight(with Filter) (KG)	42.5	42.5
Allowable momentary power loss time(s)	2.0	
Enclosure	IP20/NEMA1	

Model : E510-□□□ - SH3(F)	450	460	475
Horse power (HP)	50	60	75
HD/ND Suitable motor capacity (kW)	37/45	45/55	55/75
HD/ND Rated output current (A)	75/88	91/103	118/145
HD/ND Rated capacity (KVA)	57.2/67.1	69.3/78.5	89.9/111
Input voltage range(V)	Three phase : 380~480V,50/60Hz		
Allowable voltage fluctuation	+ 10% - 15%		
Output voltage range(V)	Three phase : 0~480V		
Input current (A)*	81.5/95.7	98.9/112	130/159
Inverter net weight (KG)	23.2	23.2	23.2
Inverter net weight(with Filter) (KG)	42.5	42.5	42.5
Allowable momentary power loss time(s)	2.0	2.0	2.0
Enclosure	IP20/NEMA1		

Notes :

1. Take standard 4-poles induction motor as the base.
2. E510s model is designed to use in heavy duty conditions, the factory setting is HD (Heavy Duty type) mode.
3. The overload capacity of E510s model HD (Heavy Duty) is 150%/1min, 200%/2sec. See the table below for the carrier frequency default setting and range.
4. The overload capacity of E510s model ND (Normal Duty) is 120%/1min, carrier frequency range is 1kHz~16kHz, the default setting is 2kHz.
5. If the carrier frequency is greater than default, it need to adjust the load current based on the de-rating curve.

Inverter voltage and capacity		HD mode carrier frequency range			ND mode carrier frequency range
200V Class	400V Class	V/F	SLV	PMSLV	
1~20HP	1~25HP	1~16kHz	4~16kHz	4~8kHz	5kHz
	30HP	1~16kHz	4~16kHz(6)	4~8kHz	5kHz
25~40HP	40~50HP	1~12kHz	4~12kHz(6)	4~8kHz	5kHz
	60~75HP	1~10kHz	4~10kHz	4~8kHz	5kHz

6. If control mode (00-00) is set to 2 (SLV mode) and maximum frequency (01-02) is larger than 80Hz, the carrier frequency range is 2~8kHz.

The following table shows maximum output frequency for each control mode.

Duty Cycle	Control Mode	Other Settings	Max. Output Frequency
Heavy Duty (00-27=0)	V/F	Maximum output frequency is 599Hz	599Hz
	SLV	200V 1~10HP, 400V 1~15HP	150Hz
		200V 15~20HP, 400V 20HP	110Hz
		400V 25HP	100Hz
		200V 25~40HP, 400V 30~75HP, carrier (11-01) is set as 8K or below 8K	100Hz
	200V 25~40HP, 400V 30~75HP, carrier (11-01) is above 8K	80Hz	
PMSLV	Please refer parameter group 22 of chapter 4.3 (PM motor parameter group)	599Hz	
Normal Duty (00-27=1)	V/F	200V 25~40HP, 400V 30~75HP The maximum frequency is 120Hz	120Hz
	SLV /PMSLV	Without standard loading mode	-

Model No.	Input Voltage (V)	Input Current (A)	Max. Output Voltage (V)	Rated Output Current (A)	Output Power (KW)
11-301-21-xxx-30 series					
11-301-21-2P5-30	200-240 / 1φ	8.5	240/3φ	3.1	0.4
11-301-21-201-30	200-240 / 1φ	12	240/3φ	4.5	0.75
11-301-21-202-30	200-240 / 1φ	16	240/3φ	7.5	1.5
11-301-21-203-30	200-240 / 1φ	23.9	240/3φ	10.5	2.2
11-301-43-xxx-30 series					
11-301-43-401-30	380-480 / 3φ	4.2	480/3φ	2.3	0.75
11-301-43-402-30	380-480 / 3φ	5.6	480/3φ	3.8	1.5
11-301-43-403-30	380-480 / 3φ	7.3	480/3φ	5.2	2.2
11-301-43-405-30	380-480 / 3φ	11.6	480/3φ	9.2	4.0
11-301-43-408-30	380-480 / 3φ	17.0	480/3φ	13.0	5.5
11-301-43-410-30	380-480 / 3φ	23.0	480/3φ	17.5	7.5
11-301-43-415-30	380-480 / 3φ	31.0	480/3φ	24	11
11-301-43-420-30	380-480 / 3φ	38.0	480/3φ	32	15
11-301-43-425-30	380-480 / 3φ	48.0	480/3φ	40	18.5
11-301-43-430-30	380-480 / 3φ	48.9/63.0	480/3φ	45/58	22/30
11-301-43-440-30	380-480 / 3φ	65.2/78.3	480/3φ	60/73	30/37
11-301-43-450-30	380-480 / 3φ	81.5/95.7	480/3φ	75/88	37/45
11-301-43-460-30	380-480 / 3φ	98.9/112	480/3φ	91/103	45/55
11-301-43-475-30	380-480 / 3φ	130/159	480/3φ	118/145	55/75

- For 11-301-43-430/40/50/60/75-30, these models have two operation modes for setting.
- N.D : Normal Duty operation mode.
- H.D : Heavy Duty operation mode.

3.4.2 General specifications

Item		E510s
Control mode		V/F, SLV, PMSLV control mode
Frequency	Output Frequency	0.01 ~ 599.00Hz
	Starting Torque	150% / 1Hz (SLV mode) · 150% / 3Hz(V/F mode)
	Frequency resolution	Digital input : 0.01Hz Analog input : 0.06Hz/60Hz
	Frequency setting	Keypad : set directly with ▲▼ keys or the VR on the keypad External input terminals : AI1 · AI2 (0/2-10V, 0/4-20mA) Multifunction input UP/DOWN function(Group 3) Set frequency by communication method
	Frequency limit	Lower and upper frequency limits 3 skip frequency settings.
Run	Operation set	Keypad RUN/STOP button External terminals : Multi-operation mode 2/3 wires selection JOG operation Run signal by communication method
Main Control Features	V / F curve setting	15 fixed curves and 1 customized curve
	Carrier frequency	1 ~ 16kHz (factory setting is 5kHz)
	Acceleration and deceleration control	2 off acceleration/deceleration time parameters 4 off S curves parameters
	Multifunction input	Refer to description on Group 3
	Multifunction output	Refer to description on Group 3
	Multifunction analog output	Refer to description on Group 4
	Main features	Overload detection, 16 preset speed, Auto-run, Acc/Dec switch(2 stages), Main/Alt run command select, Main/Alt frequency command select, PID control, Torque boost, Fault reset, Fire mode, Multi-Pump function.
Display	LED display	Parameter, Parameter value, Frequency, Line speed, DC voltage, Output voltage, Output current, PID feedback, Input and output terminal status, Heat sink temperature, Firmware version, Fault list.
	LED status indicator	Run, Stop, Forward, Reverse and etc.
Protective Functions	Overload protection (OL1)	Electrical overload protection curve
	Overload protection (OL2)	H.D mode : 150% for 60s (200% for 2s) N.D mode : 120% for 60s
	Over voltage	200V Class : DC bus voltage higher than 410Vdc 400V Class : DC bus voltage higher than 820Vdc
	Under Voltage	200V Class : DC bus voltage lower than 190V 400V Class : DC bus voltage lower than 380V
	Momentary Power Loss Restart	Inverter auto-restart after a momentary power loss
	Stall Prevention	Stall prevention for acceleration/deceleration operation
	Short-circuit output terminal	Electronic circuit protection
	Grounding Fault	Electronic circuit protection
	Other protection features	Protection for overheating of heat sink, Fault output, Reverse prohibit, Prohibit for direct start after power up and error recovery, Parameter lock up, STO (Safety Torque Off).

Communication control		Built-in RS485 communication for one to one or one to many. Built-in BACnet communication for building control. (Ex : Fire protection system, Air conditioning system, Monitoring system and Access control system)
Environment	Operating temperature	IP20/NEMA1 type : -10~50°C(without sticker or upper dust cover) -10~40°C(with sticker or upper dust cover)
	Storage temperature	-20 ~ 60°C
	Humidity	95% RH or less (no condensation) (Follow IEC60068-2-78 standard)
	Vibration	Frequency : 10Hz to 150Hz and return to 10Hz Amplitude : 0.3mm (10Hz to 50Hz) Acceleration : 2G (50Hz to 150Hz) (According to IEC60068-2-6 standard)
	Enclosure	IP20/NEMA1

3.4.3 De-rating curve

The curves are showing the applicable output current de-rate due to setting of carrier frequency and the ambient operating temperatures of 40 and 50 degrees.

- When the carrier frequency under than 10KHz, ambient temperature will not effect rated current.
- When the carrier frequency higher than 10KHz :
If the ambient temperature is under 40°C, inverter can output 100% rated current on 2-10KHz.
16KHz only can be used 85% output current.
If the ambient temperature is under 50°C, inverter only can output 85% rated current on 2-16KHz.
- It is required to derate 1.5% of output current at each additional degrees once the ambient inverter is higher than 50 degrees (The maximum ambient temperqture is 60 degrees).

Note :

----- De-rating curve of 40°C ambient temperature

..... De-rating curve of 50°C ambient temperature

Frame 1/2/3/4 (Single phase/Three phase 200V 2HP, Three phase200V 0.5~2HP/5HP~20HP)

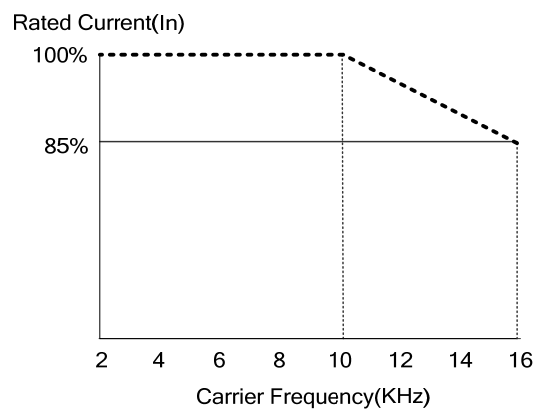

Frame2 (Three phase 200V 3HP)

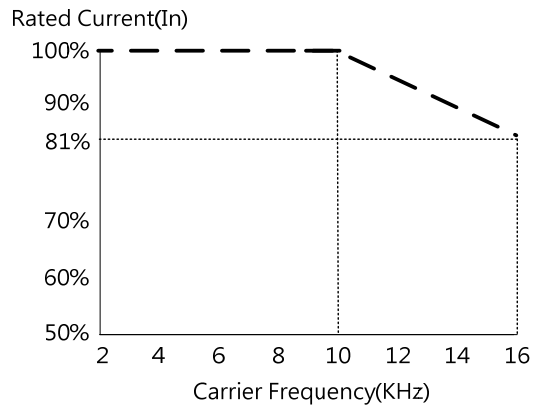

Frane 5/6 (Three 200V 25HP)

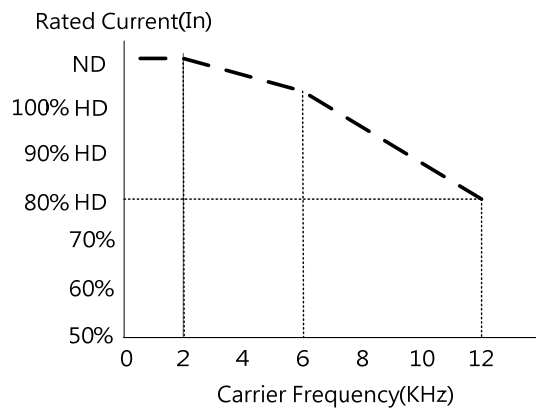

Frame 5/6 (Three phase 200V 30HP · 40HP)

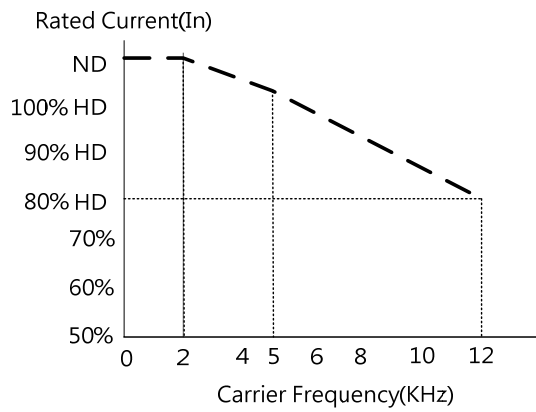

Frame 1/2/3 (Three phase 400V 1HP~5HP, 10HP, 20HP~25HP)

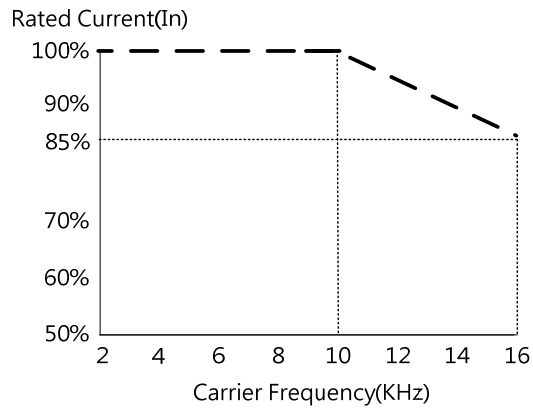

Frame 3 (Three phase 400V 8HP)

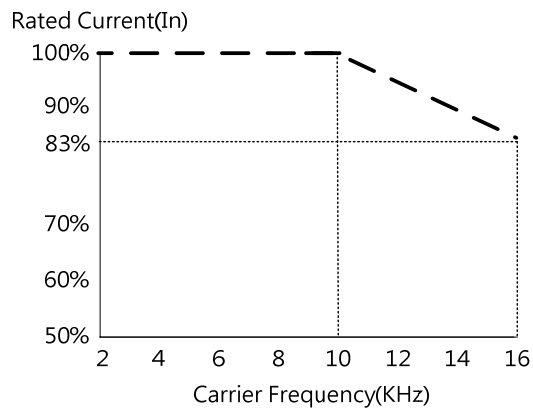

Frame 3 (Three phase 400V 15HP)

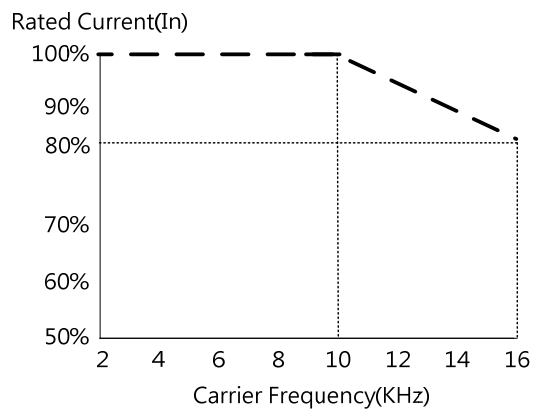

Frame 5 (Three phase 400V 30HP)

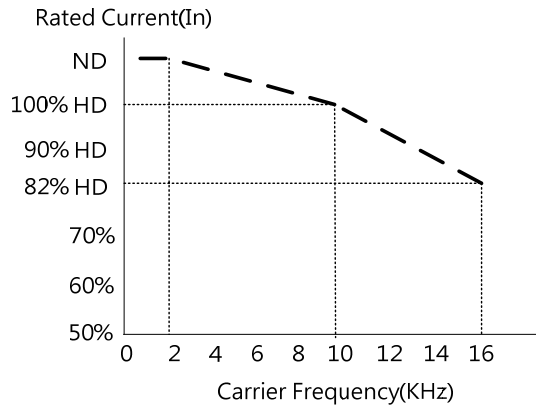

Frame 6 (Three phase 400V 40HP~50HP)

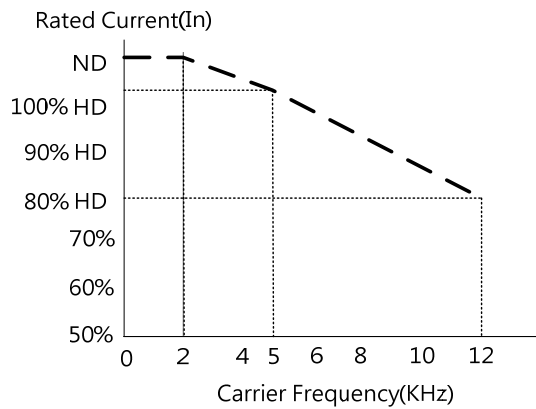

Frame 6 (Three phase 400V 60HP~75HP)

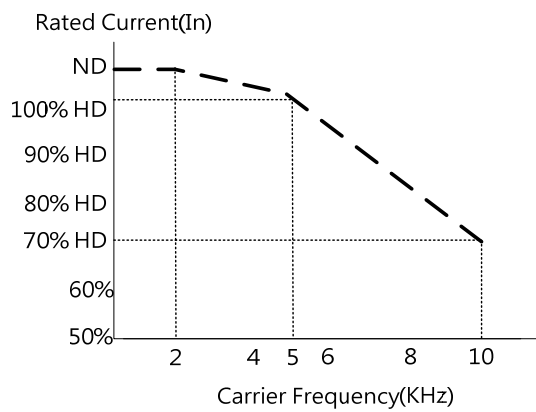

3.4.4 Capacitor Reforming Guide After Long Storage

For correct performance of this product after long storage before use it is important that Inverter Capacitors are reformed according to the guide below :

Storage time	Procedure to re-apply voltage
≤ 1 year	Apply rated voltage of inverter in the normal way
Between 1-2 years	Apply rated voltage of inverter(Note1) to the product for one hour before using the inverter
≥ 2 years	Use a variable AC power supply to 1. Connecting 25% rated voltage of inverter for 30 minutes. 2. Connecting 50% rated voltage of inverter for 30 minutes. 3. Connecting 75% rated voltage of inverter for 30 minutes. 4. Connecting 100% rated voltage of inverter for 210 minutes. Once the procedures completed, inverter just can be used normally

Note1 : Please refer the rated voltage according to model label of inverter.

3.5 Standard Wiring

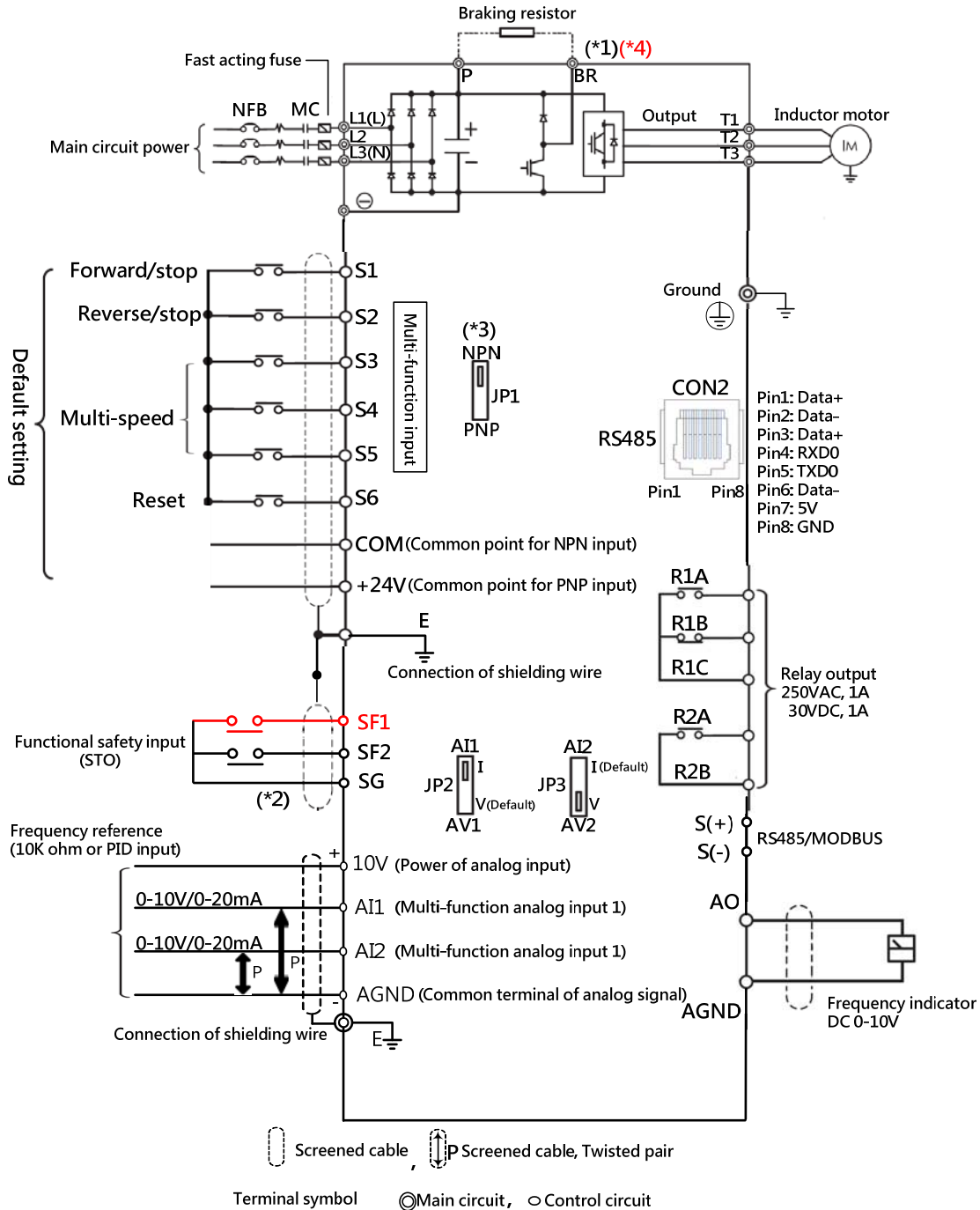

Remark :

- (*1) Models 200V 0.5-25HP and 400V 1-40HP with built-in braking transistor, braking transistor can be connected directly between P and BR.
- (*2) Safety input connector (SF/SG) should be shorted so that inverter outputs properly. When the safety input is used, please be sure to remove the short-pin between SF/SG.
- (*3) The multi-function digital input terminals S1-S6 can be set to Sink(NPN) and Source(PNP) by JP1.
- (*4) Models 200V 25HP and 400V 30HP and higher ratings provides P1 terminal for DCL connected, please connect wiring correctly according to the next section.

3.6 Terminal description

3.6.1 Description of main circuit terminal

Terminal symbol	200V : 0.5-20HP 400V : 1-25HP	200V : 25HP 400V : 30HP	200V : 30-40HP 400V : 40-75HP
L1(L), R/L1	Main power input 1 phase : L1(L)-L3(N) 3 phase : L1(L)-L2-L3(N)	Main power input 3 phase : R/L1-S/L2-T/L3	Main power input 3 phase : R/L1-S/L2-T/L3
L2, S/L2			
L3(N), T/L3			
P	Externally connected braking resistor	-	-
BR			
⊖	-	-	⊖-P1 : Externally connected braking resistor P1-P2 : Externally connected DCL
P1	-	P1-P2/B1 : Externally connected DCL P2/B1-B2 : Externally connected braking resistor	
P2/B1			
B2			
P2			
T1	Inverter output, connect to U/V/W terminals of motor		
T2			
T3			
⊕	Ground terminal		

- Main power terminal of Single phase 200V Class 0.5~1HP

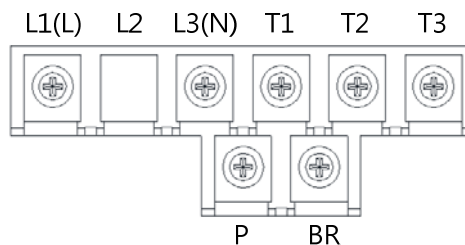

Notes : The screw on L2 terminal will be removed for single phase input supply models.

- Main power terminal of Single/Three phase 200V Class 0.5~1HP and Three phase 400V Class 1~2HP.

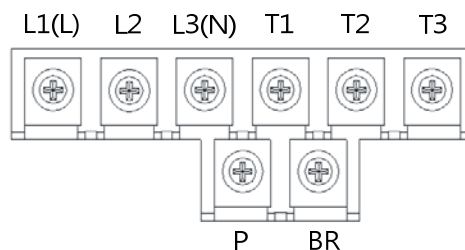

- Main power terminal of Single/Three phase 200V Class 2~3HP

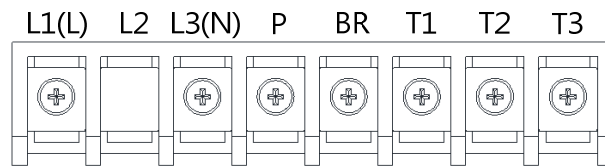

- Main power terminal of Single/Three phase 200V Class 2~3HP, Three phase 200V Class 5HP and Three phase 400V Class 3~5HP

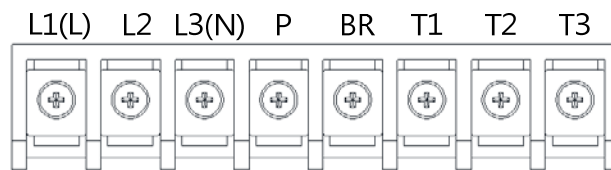

- Main power terminal of Three phase 200V Class 7.5~20HP and Three phase 400V Class 7.5~20HP

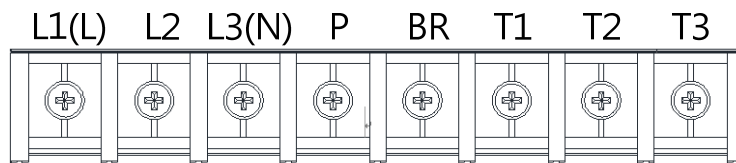

- Main power terminal of Three phase 200V Class 25HP and Three phase 400V Class 30HP

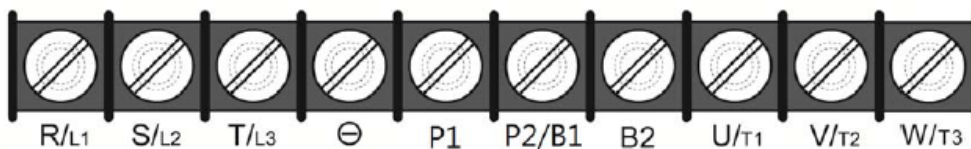

- Main power terminal of Three phase 200V Class 30~40HP and Three phase 400V Class 40~75HP

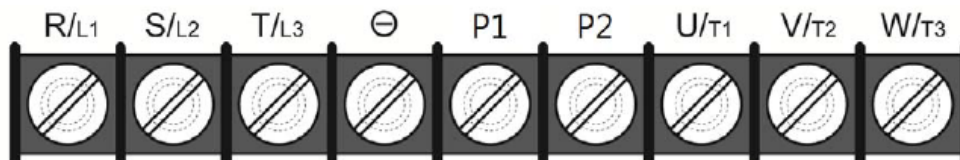

3.6.2 Description of control circuit terminal

Type	Terminal	Function		Signal level
Digital Input	S1	Please refer to group3 (digital input functions) for default setting and setting range.		24 VDC, 8 mA photocoupler isolation. (The max. input voltage is 30 Vdc, input resistance is 4.3kΩ) High Logic: 13V Low Logic: 10V
	S2			
	S3			
	S4			
	S5			
	S6			
Relay Output	R1A	Normal Open	Please refer to group3 (digital output functions) for default setting and setting range.	250VAC/1A (30VDC/1A)
	R1B	Normal Close		
	R1C	Common Point		
	R2A	Normal Open		
	R2B			
24Vdc Supply	24V	Common point of PNP input (JP1 switch to PNP)		±15% (max output current is 60mA)
	COM	Common point of NPN input (JP1 switch to NPN)		
Analog Input	10V	Built-in power for external potentiometer		10V (max current is 20mA)
	AI1/AV1	Multi-analog input 1 (0-10V/0-20mA) (Please use JP2 to select voltage or current input)		Resistance for voltage input is 153KΩ; for current input is :500Ω
	AI2/AV2	Multi-analog input 2 (0-10V/0-20mA) (Please use JP3 to select voltage or current input)		
	AGND	Analog input common point.		----
		Ground terminal.		----
Analog Output	AO	Analog output terminal.		0-10V,(max current is 2mA)
	AGND	Analog input common point.		----
STO Terminal	SF1,SF2	The default status of safety switch is normal close, when the terminal becomes to normal open status, output voltage of inverter will be cut off.		24V for SF1/SF2
	SG			
RS485 Modbus	S(+)	RS485/MODBUS (Baud rate setting 9600~38400)		Differential input and output
	S(-)			

Control terminal :

R2A	R2B	R1A	R1B	R1C		S1	S3	S5	24V	AI1	AI2
S(+)	S(-)	SF1	SG	SF2	COM	S2	S4	S6	AGND	10V	AO

Jumper function description

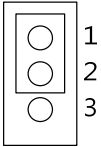
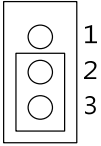
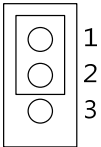
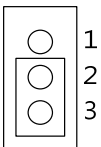
Jumper	Symbol	Function	Signal reference	Note
JP1		NPN/PNP selectable	NPN input	Factory default setting
			PNP input	
JP2 /JP3		External signal type selection	0-20mA / 4-20mA Analog signal	Set parameter 00-05/00-06 to 2 or 3 (External analog input) to become effective
			0/2-10V Analog signal	

3.7 Outline dimensions

➤ IP20 dimensions

200V Class single phase : 0.5HP~1HP

200V Class three phase : 2HP

400V Class three phase : 1HP~2HP

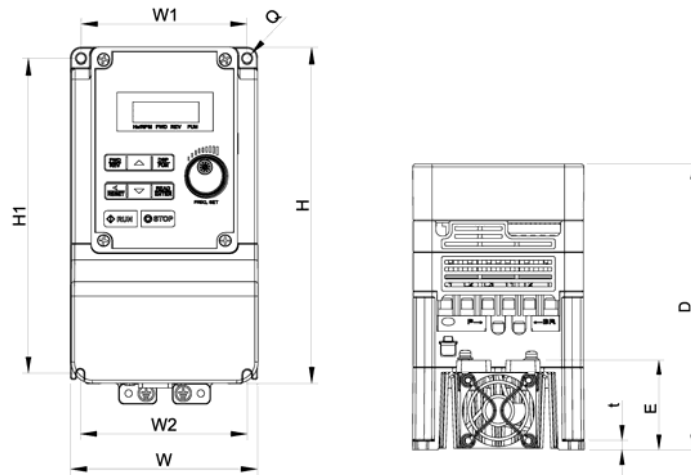

Inverter Model	Dimensions in mm (inch)									Net Weight Kg/(lbs)
	W	W1	W2	H	H1	D	E	t	Q	
E510-2P5-SH	90.6 (3.57)	80.5 (3.17)	80.5 (3.17)	164 (6.46)	153 (6.02)	151.4 (5.96)	47 (1.85)	5 (0.19)	M4	1.5/(3.3)
E510-201-SH										
E510-2P5-SH1F										
E510-201-SH1F										
E510-202-SH3										
E510-401-SH3										
E510-402-SH3										
E510-401-SH3F										
E510-402-SH3F										1.58/(3.48)

200V Class single/three phase : 2HP

400V Class three phase : 3~25HP

200V Class three phase : 3~20HP

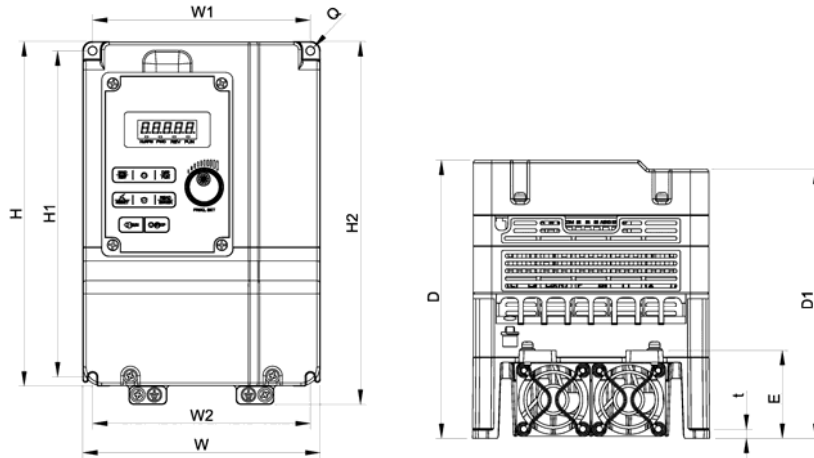

Inverter Model	Dimensions in mm (inch)											Net Weight Kg/(lbs)
	W	W1	W2	H	H1	H2	D	D1	E	t	Q	
E510-202-SH	128.7 (5.07)	118 (4.65)	118 (4.65)	187.6 (7.39)	177.6 (6.99)	197.5 (7.78)	152.4 (6)	147.4 (5.8)	48.2 (1.9)	5 (0.19)	M4	2.0/(4.41)
E510-203-SH												
E510-202-SH1F												
E510-203-SH1F												
E510-205-SH3												
E510-403-SH3												
E510-405-SH3												
E510-403-SH3F												
E510-405-SH3F												
E510-208-SH3	186.9 (7.36)	175 (6.89)	176 (6.93)	260.9 (10.27)	249.8 (9.83)	273 (10.75)	202.6 (7.98)	197.6 (7.78)	76.7 (3.02)	6.5 (0.26)	M4	6.0/(13.23)
E510-210-SH3												
E510-408-SH3												
E510-410-SH3												
E510-415-SH3												
E510-408-SH3F												
E510-410-SH3F												
E510-415-SH3F												
E510-215-SH3	224.6 (8.84)	207 (8.15)	207 (8.15)	321.6 (12.66)	303.5 (11.95)	330.9 (13.03)	206.1 (8.11)	201.1 (7.92)	94 (3.7)	8 (0.31)	M5	10.0/(22.05)
E510-220-SH3												
E510-420-SH3												
E510-425-SH3												

200V Class three phase : 25HP

400V Class three phase : 30HP

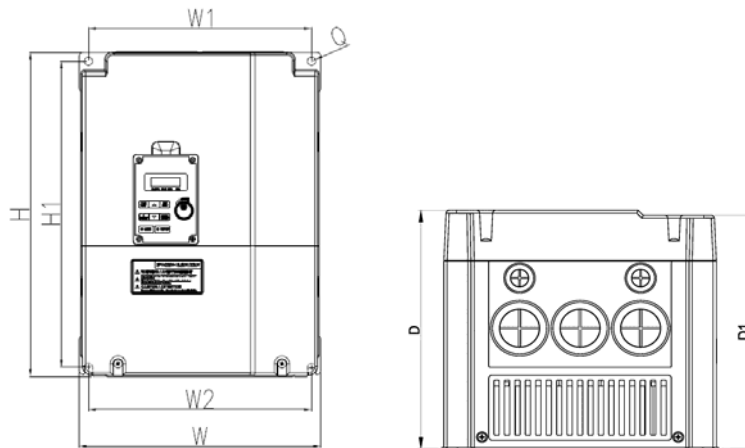

Inverter Model	Dimensions in mm (inch)									Net Weight Kg/(lbs)
	W	W1	W2	H	H1	D	D1	t	Q	
E510-225-SH3	265	245	245	360	340	238.2	233.2	1.6	M8	10.0/(22.05)
E510-430-SH3	(10.43)	(9.65)	(9.65)	(14.17)	(13.39)	(9.38)	(9.18)	(0.06)		

200V Class three phase : 30~40HP

400V Class three phase : 40~75HP

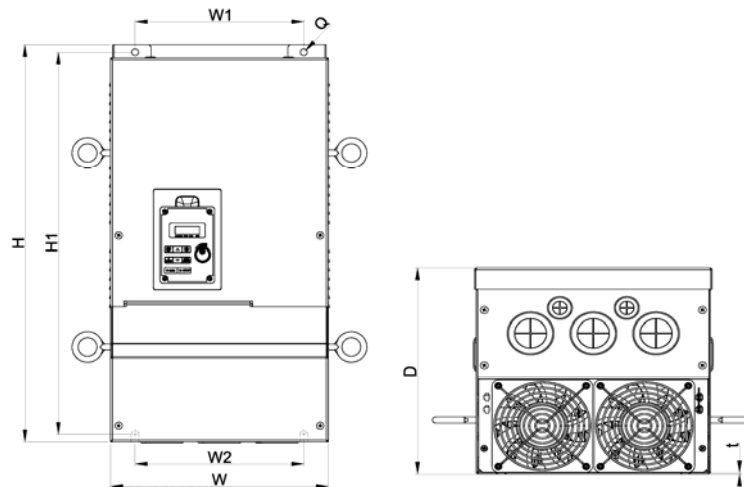

Inverter Model	Dimensions in mm (inch)								Net Weight in Kg/(lbs)
	W	W1	W2	H	H1	D	t	Q	
E510-230-SH3	286.5 (11.28)	220 (8.66)	220 (8.66)	525 (20.67)	505 (19.88)	269.8 (10.62)	3.3 (0.13)	M8	23.2/(51.15)
E510-240-SH3									
E510-440-SH3									
E510-450-SH3									
E510-460-SH3									
E510-475-SH3									

➤ NEMA 1 dimensions

200V Class single phase : 0.5~1HP

400V Class three phase : 1~2HP

200V Class three phase : 2HP

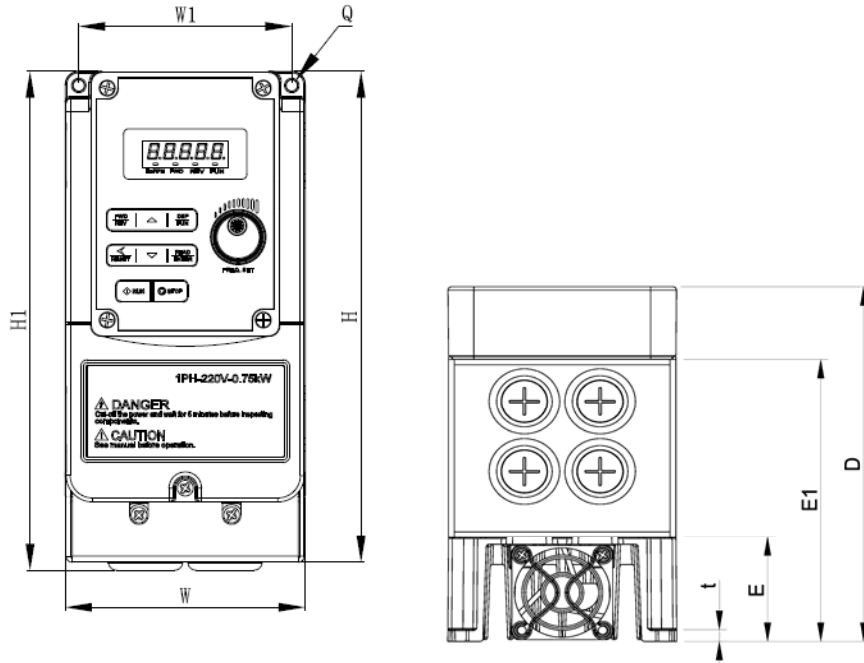

Inverter Model	Dimensions in mm (inch)									Net Weight in Kg/(lbs)
	W	W1	H	H1	D	E	E1	t	Q	
E510-2P5-SH	90.6 (3.57)	80.5 (3.17)	186.2 (7.33)	189.2 (7.45)	151.4 (5.96)	47 (1.85)	120.5 (4.74)	5 (0.19)	M4	1.9/(4.19)
E510-201-SH										
E510-2P5-SH1F										
E510-201-SH1F										
E510-202-SH3										
E510-401-SH3										
E510-402-SH3										
E510-401-SH3F										2.0/(4.41)
E510-402-SH3F										

200V Class single phase/three phase : 2HP

400V Class three phase : 3~25HP

200V Class three phase : 3~20HP

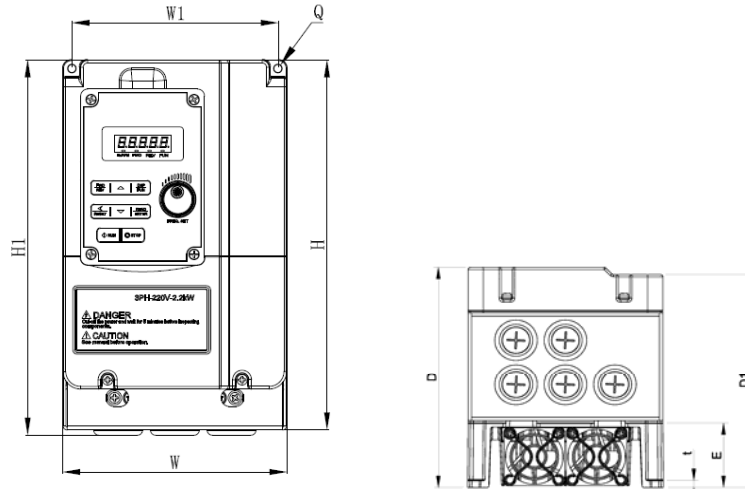

Inverter Model	Dimensions in mm (inch)										Net Weight Kg/(lbs)
	W	W1	H	H1	D	D1	E	E1	t	Q	
E510-202-SH	128.7 (5.06)	118 (4.65)	210.6 (8.29)	213.6 (8.41)	152.4 (6)	147.4 (5.8)	48.2 (1.9)	121.1 (4.77)	5 (0.19)	M4	2.9/(6.39)
E510-203-SH											
E510-202-SH1F											
E510-203-SH1F											
E510-205-SH3											
E510-403-SH3											
E510-405-SH3											
E510-403-SH3F											
E510-405-SH3F											
E510-208-SH3											
E510-210-SH3											
E510-408-SH3											
E510-410-SH3											
E510-415-SH3											
E510-408-SH3F											
E510-410-SH3F											
E510-415-SH3F											
E510-215-SH3	224.6 (8.84)	207 (8.15)	358.3 (14.1)	363.3 (14.3)	206.1 (8.11)	201.1 (7.92)	94 (3.7)	174 (6.85)	8 (0.31)	M4	11.0/(24.25)
E510-220-SH3											11.4/(25.13)
E510-420-SH3											
E510-425-SH3											

400V Class three phase : 20~30HP (built-in EMC filter)

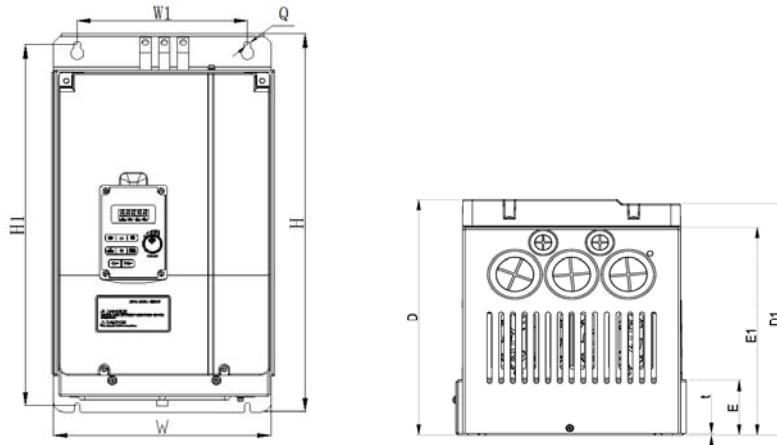

Inverter Model	Dimensions in mm (inch)										Net Weight Kg/(lbs)
	W	W1	H	H1	D	D1	E	E1	t	Q	
E510-420-SH3F	235.6	180	400	381.5	267.1	262.1	62	237	4	M6	18.9/(41.67)
E510-425-SH3F	(9.28)	(7.09)	(15.75)	(15.02)	(10.52)	(10.32)	(2.44)	(9.33)	(0.16)		
E510-430-SH3F	269	230	462	440	318.2	313.2	80	267.6	4	M8	22.8/(50.27)
	(10.59)	(9.05)	(18.19)	(17.32)	(12.53)	(12.33)	(3.15)	(10.54)	(0.16)		

400V Class three phase : 40~75HP (built-in EMC filter)

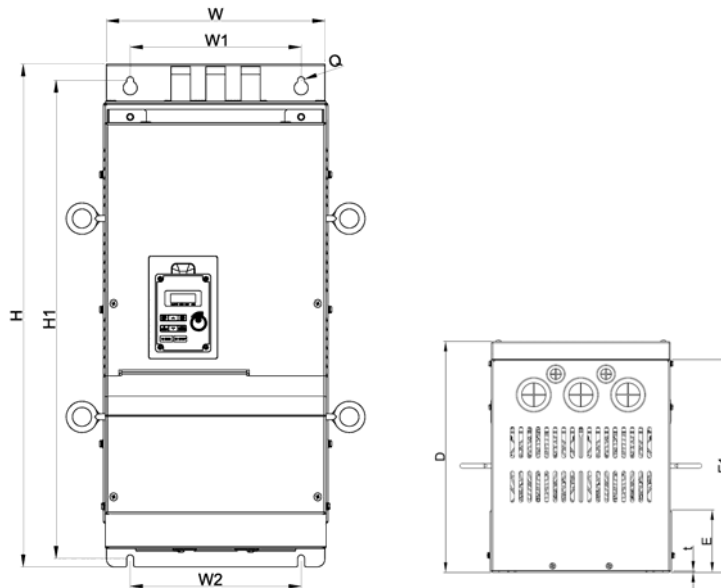

Inverter Model	Dimensions in mm (inch)										Net Weight Kg/(lbs)
	W	W1	W2	H	H1	D	E	E1	t	Q	
E510-440-SH3F	288.9	220	220	652	620	369.8	90	331.1	4	M8	47.2
E510-450-SH3F											
E510-460-SH3F											
E510-475-SH3F											
	(11.37)	(8.66)	(8.66)	(25.67)	(24.41)	(14.56)	(3.54)	(13.04)	(0.16)		(104.07)

IP66 Dimensions

200V Single phase : 0.5~1HP

200V Single/Three phase : 0.5~1HP

400V Three phase : 1~2HP

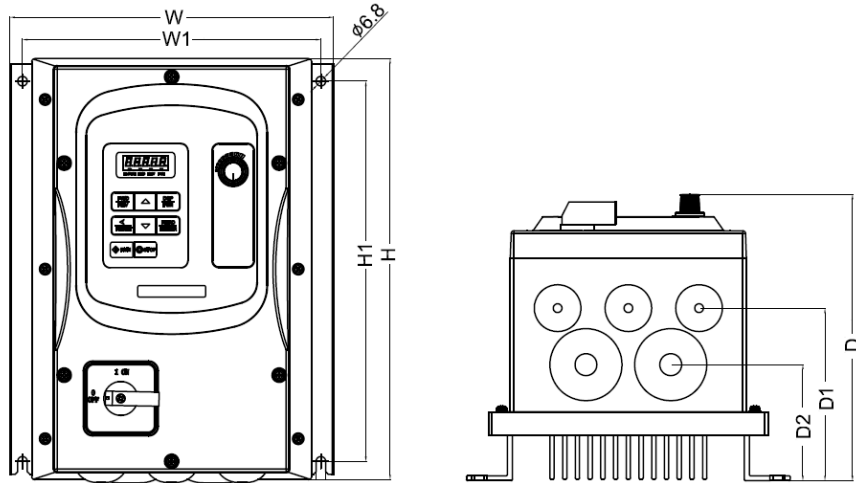

Inverter Model	Dimensions in mm (inch)								Net Weight in Kg/(lbs)	
	W	W1	H	H1	D	D1	D2	Ø		
E510-2P5-SH1FN4S									M6	3.0/(6.6)
E510-201-SH1FN4S										
E510-2P5-SH1FN4										
E510-201-SH1FN4										
E510-2P5-SHN4										
E510-201-SHN4	229	211	298	269	202.6	122.1	82.1			
E510-401-SH3FN4S	(9.01)	(8.30)	(11.73)	(10.59)	(7.97)	(4.80)	(3.23)			
E510-402-SH3FN4S										
E510-401-SH3FN4										
E510-402-SH3FN4										
E510-401-SH3N4										
E510-402-SH3N4										

200V Single phase : 2~3HP

200V Three phase : 5HP

400V Three phase : 3~5HP

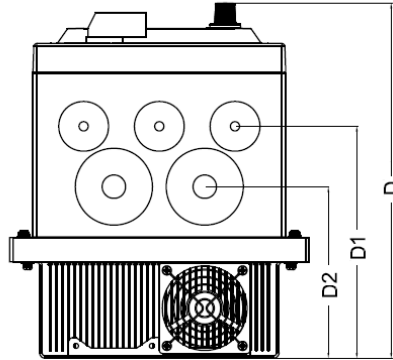
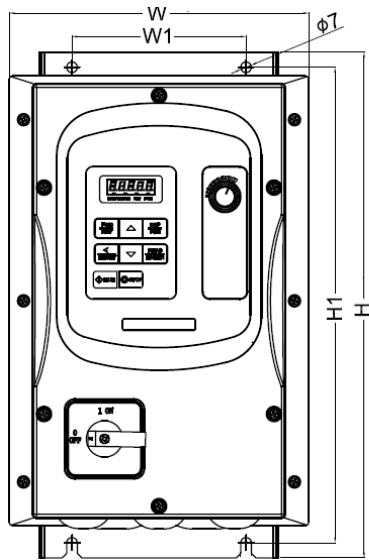

Inverter Model	Dimensions in mm (inch)								Net Weight Kg/(lbs)
	W	W1	H	H1	D	D1	D2	∅	
E510-202-SH1FN4S	198 (9.63)	115 (5.59)	335 (16.30)	315 (15.33)	235.3 (11.45)	153.6 (7.47)	113.6 (5.53)	M6	5.9/(13.0)
E510-203-SH1FN4S									
E510-202-SH1FN4									
E510-203-SH1FN4									
E510-202-SHN4									
E510-203-SHN4									
E510-205-SH3N4									
E510-403-SH3FN4S									
E510-405-SH3FN4S									
E510-403-SH3FN4									
E510-405-SH3FN4									
E510-403-SH3N4									
E510-405-SH3N4									

200V Three phase : 7.5~20HP

400V Three phase : 7.5~25HP

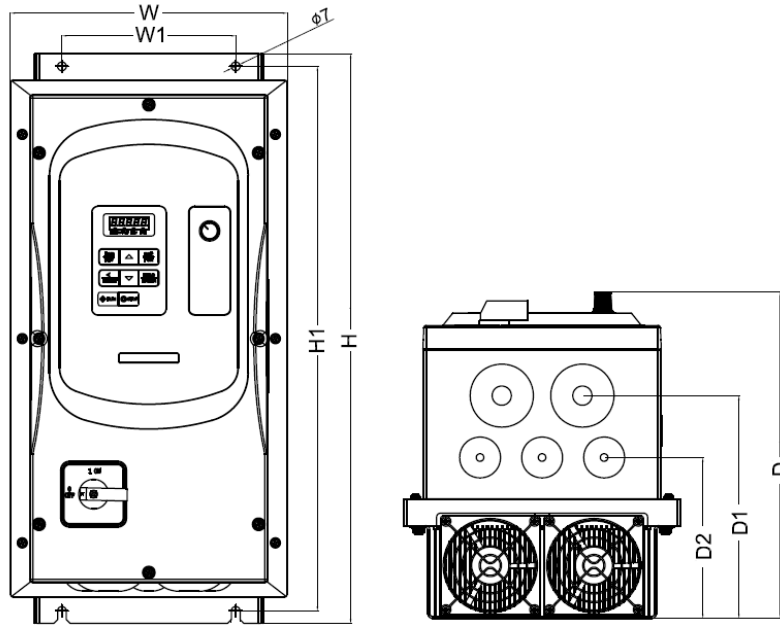

Inverter Model	Dimensions in mm (inch)								Net Weight Kg/(lbs)
	W	W1	H	H1	D	D1	D2	Ø	
E510-208-SH3N4	223 (10.58)	140 (6.81)	460 (22.39)	440 (21.42)	263.5 (12.82)	180 (8.76)	130 (6.32)	M6	13.0/(28.6)
E510-210-SH3N4									
E510-215-SH3N4									
E510-220-SH3N4									
E510-408-SH3FN4S									
E510-410-SH3FN4S									
E510-415-SH3FN4S									
E510-408-SH3FN4									
E510-410-SH3FN4									
E510-415-SH3FN4									
E510-408-SH3N4									
E510-410-SH3N4									
E510-415-SH3N4									
E510-420-SH3N4									
E510-425-SH3N4									

3.8 EMC filter disconnection

EMC filter may be disconnected :

Inverter drives with built-in EMC filter are not suitable for connection to certain type of supply systems, such as listed below; in these cases the RFI filter can be disabled.

In all such cases consult your local electrical standards requirements.

IT type supply systems (ungrounded) & certain supply systems for medical equipment.

For ungrounded supply systems If the filter is not disconnected the supply system becomes connected to Earth through the Y capacitors on the filter circuit. This could result in danger and damage to the Drive.

Disconnection steps :

- (1) Remove the front cover.
- (2) Loosen the screw.
- (3) Remove the metal link.
- (4) Tighten the screw.

Note : Disconnecting the EMC filter link will disable the filter function, please consult your local EMC standards requirement.

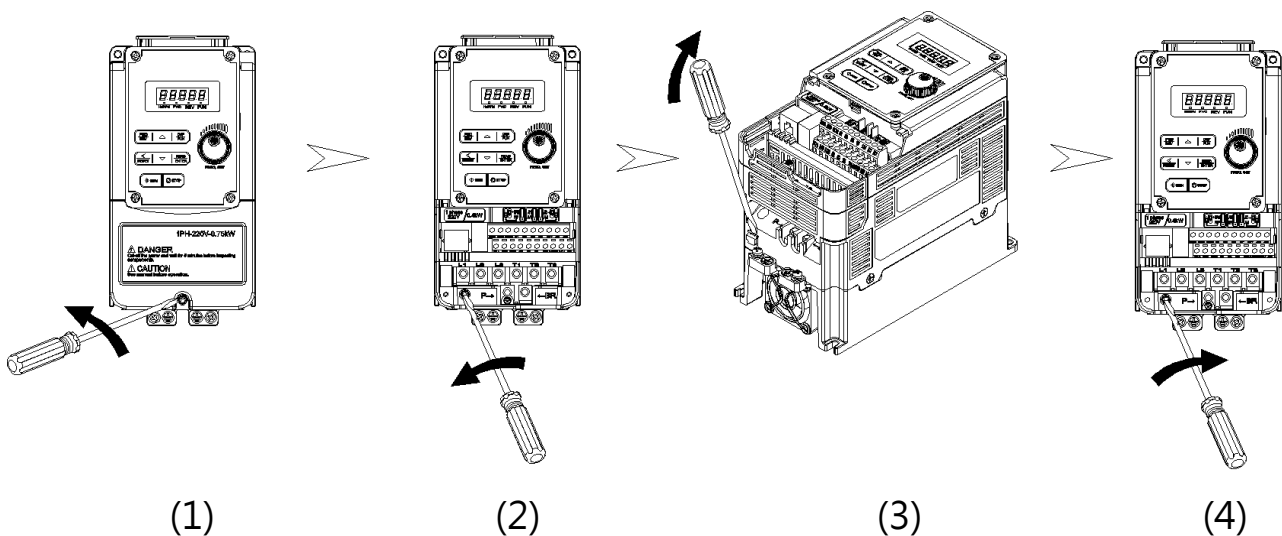

3.9 The dimension and installation of operator panel

3.9.1 Description of dimension and installation

(IP20/NEMA1) The operator panel has a LED display and can be removed for remote installation. Installation and dimension information are as follows :

➤ Dimension

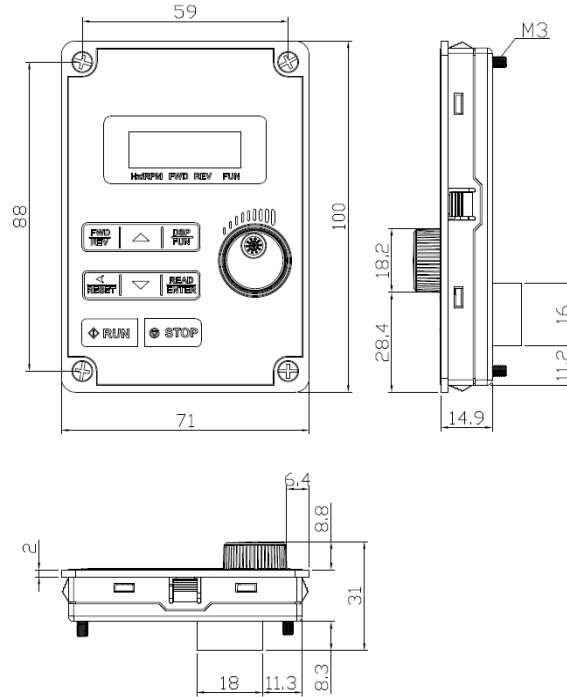

➤ Surface installation diagram

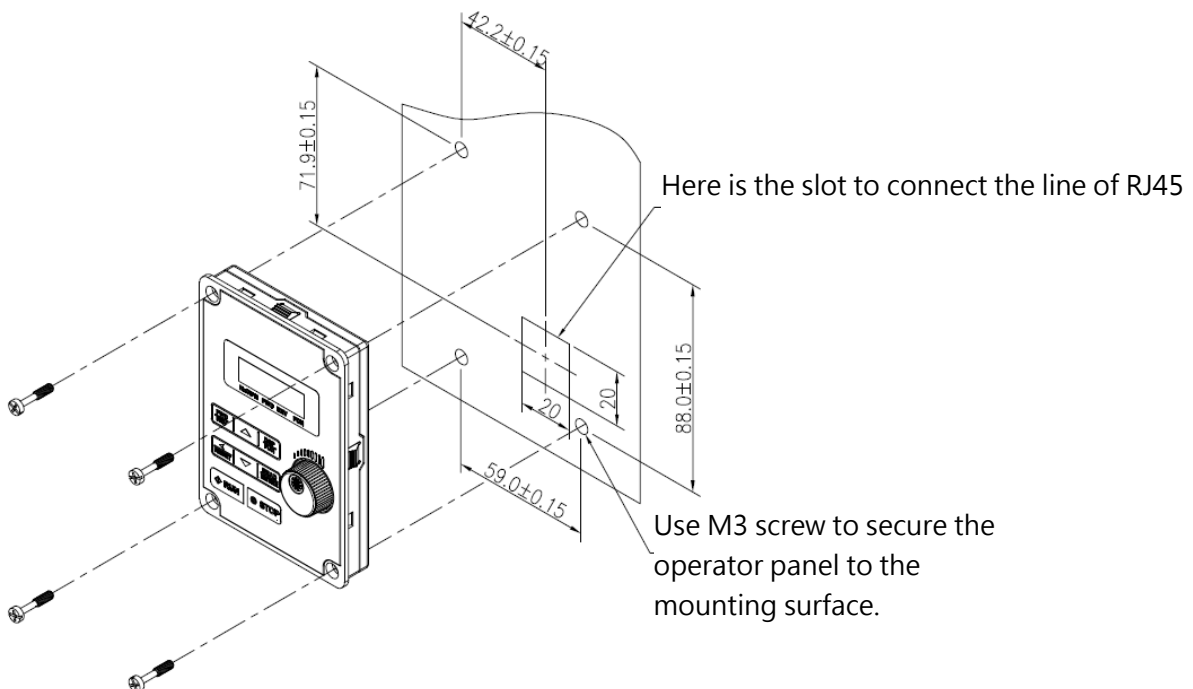

3.9.2 Description of protective cover

For remote installation of the operator panel, to avoid ingress of dust, use the supplied protective cover.

Step1 : Loosen the four screws of the operator panel

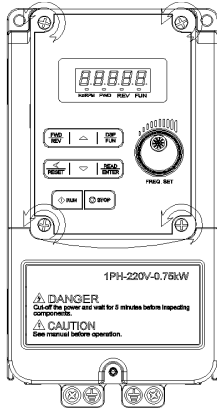

Step2 : Take out the operator panel

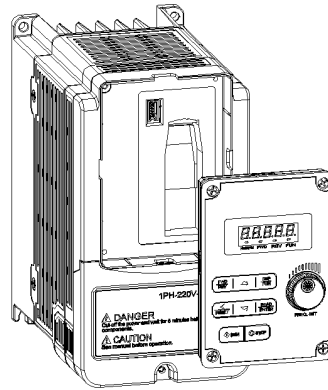
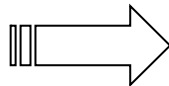

Step3 : Mount the self-adhesive protective cover as per diagram below. Push into position to locate.

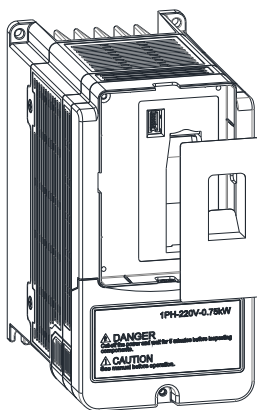

Here is the bottom of the slot

Here is the ligulate structure

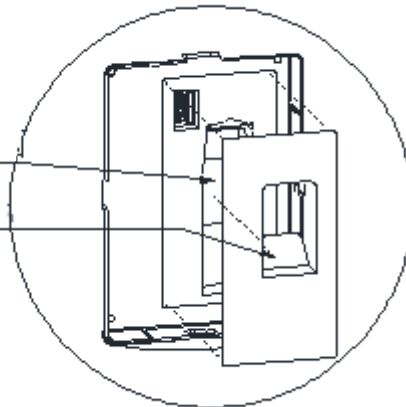

Step 4 : Installation is completed.

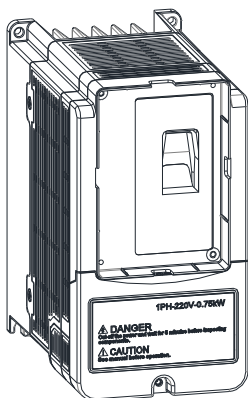

Chapter 4 Software Index

4.1 Keypad description

4.1.1 Operator panel functions



Type	Item	Functions
Digital display & LEDs	Main digital displays	Frequency Display, Parameter, voltage, Current, Temperature, Fault messages.
	LED Status	<p>Hz/RPM : ON, when the frequency or line speed is displayed. OFF, when parameters are displayed.</p> <p>FWD : ON, while the inverter is running forward, flashes while stopping.</p> <p>REV : ON, while the inverter is running reverse, flashes while stopping.</p> <p>FUN : ON, when parameters are displayed. OFF, when the frequency is displayed.</p>
Variable Resistor	FREQ SET	Used to set the frequency
Function keys (8 buttons)	RUN	Run at the set frequency.
	STOP	Decelerate or Coast to Stop.
	▲	Increment parameter number and preset Values.
	▼	Decrement parameter number and preset Values.
	FWD/REV (Dual function keys)	FWD : Forward Run REV : Reverse Run
	DSP/FUN (Dual function keys)	DSP : Switch between available displays FUN : Used to examine the parameter content
	</ RESET (Dual function keys)	< (Left Shift) : Changing the parameters or parameter Values RESET : Use to Reset alarms or resettable faults
	READ/ENTER (Dual function keys)	Used to display the preset Value of parameters and for saving the changed parameter Values.

4.1.2 Digital display description











Alpha numerical display format

Digit	LED	Letter	LED	Letter	LED	Symbol	LED
0		A		L		Y	
1		B		n		-	
2		C		o		°	
3		D		P		_	
4		E		q		.	
5		F		r			
6		G		S			
7		H		t			
8		I		u			
9		J		V			

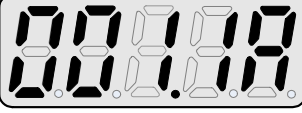



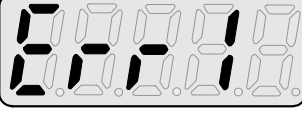

Digital tube lights flashing instructions

Actual output frequency	Set frequency	
Digits are lit Continually	Preset digits flashing	Selected digit flashing

LED display examples

Display	Description
	In stop mode shows the set frequency In run mode shows the actual output frequency
	Selected Parameter
	Parameter Value
	Output Voltage
	Output Current in Amps
	DC Bus voltage
	Temperature
	PID feedback Value, based on setting value of 12-01
	Error display, please refer the contents in chapter 5
	Analogue Current / Voltage AI1 / AI2 . Range (0~100%)

LED status description

	LED indicator light status		LED indicator flashing status	
Frequency / Line speed Indicator	 Hz/RPM	ON while displaying frequency or linear speed		
Menu mode indicator	 FUN	ON while not displaying frequency or line speed	 FUN	Flashing while fire mode enabled
FWD indicator	 FWD	ON while running forward	 FWD	Flashing while stopped in Forward mode.
REV indicator	 REV	ON while running reverse	 REV	Flashing while stopped in Reverse mode

4.1.3 LED display setup

On power up, digital display screens will be shown below.

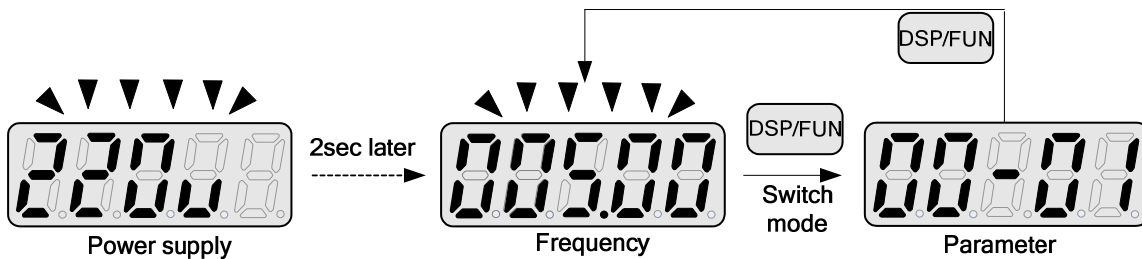

User selectable display formats :

12- 00	Display mode
	<div style="display: flex; justify-content: space-around;"> <u>0</u> <u>0</u> <u>0</u> <u>0</u> <u>0</u> </div> <p>High Low</p> <p>Each of the 5 digis can be set to any of the selections below from 0~8.</p> <div style="display: flex; justify-content: space-between;"> <div> <p>【0】 : Display display</p> <p>【3】 : DC voltage</p> <p>【6】 : AI1 input value</p> </div> <div> <p>【1】 : Output current</p> <p>【4】 : Temperature</p> <p>【7】 : AI2 input value</p> </div> <div> <p>【2】 : Output voltage</p> <p>【5】 : PID feedback</p> <p>【8】 : Counter Value</p> </div> </div>

The highest bit of 12-00 sets the power on the display, other bits set the selected display from range 0-7, as the liste above.

Example1 : Set parameter 12- 00= 【10000】 to obtain display format shown below.

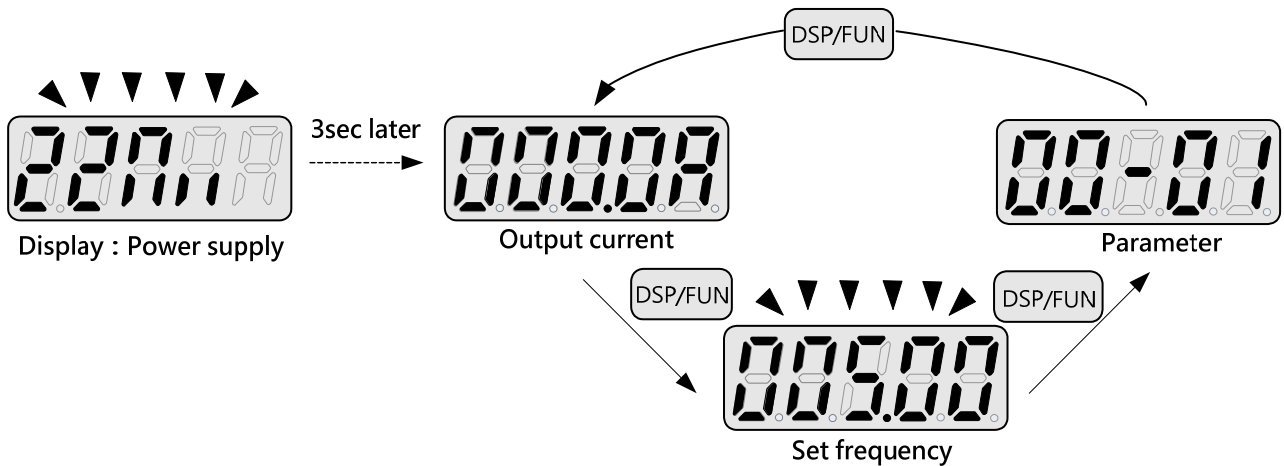

Example 2. Set parameter 12- 00= 【12345】 to obtain the display format shown below

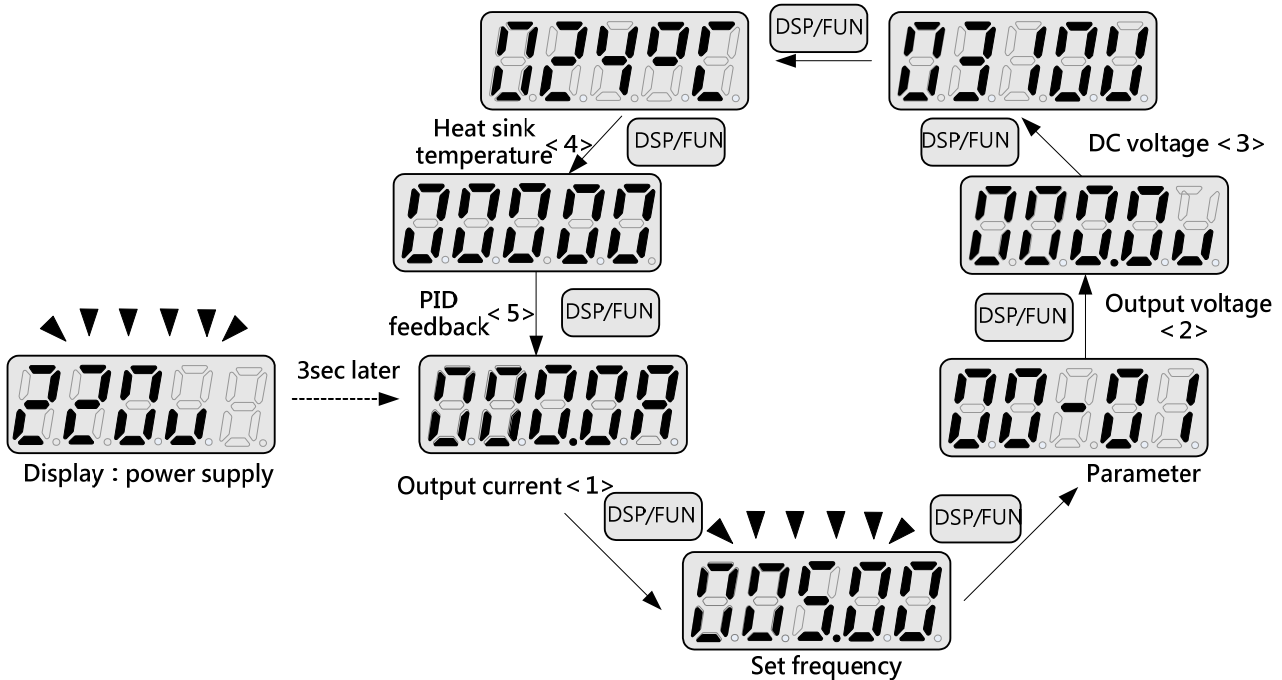

Increment/ Decrement key functions :

" ▲ key" / " ▼ key" :

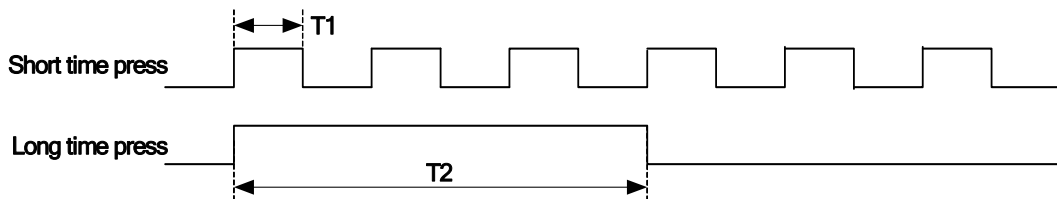

Quick pressing of these kwys will increment or decrement the selected digit by one. Extended pressing will increment or decrement the selected digit continuously.

4.1.4 Example of keypad operation

Example 1 : Modifying parameters

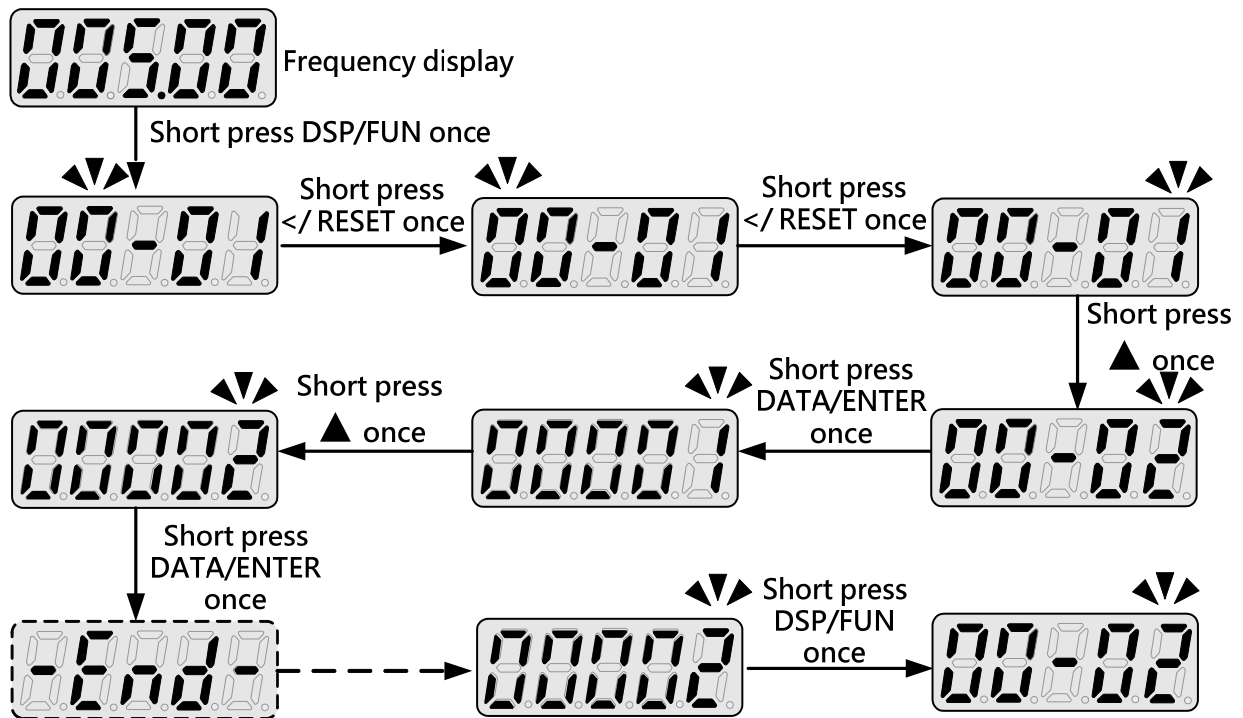

Example 2 : Modifying the frequency from keypad in run and stop modes

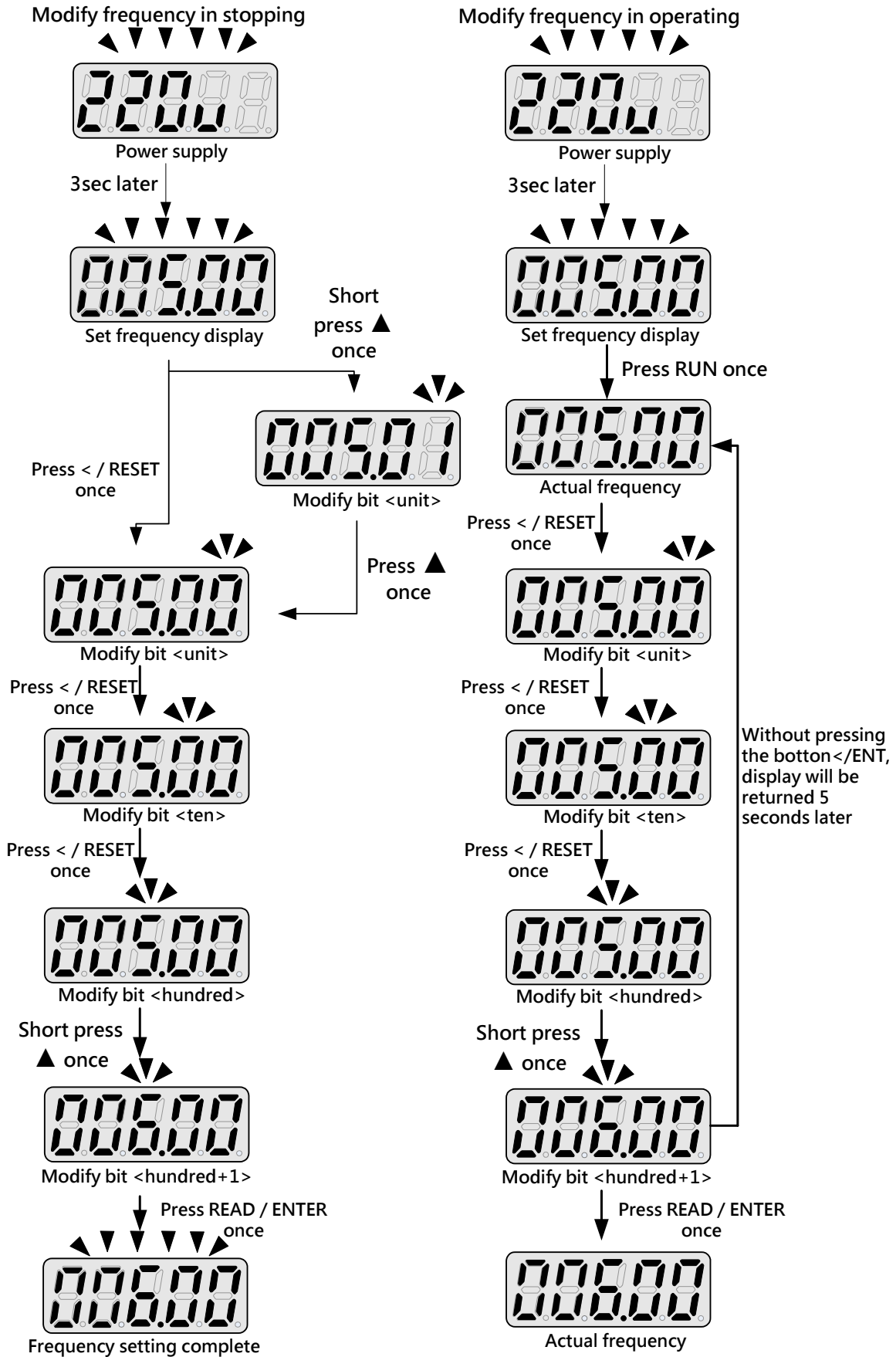

4.1.5 Operation control

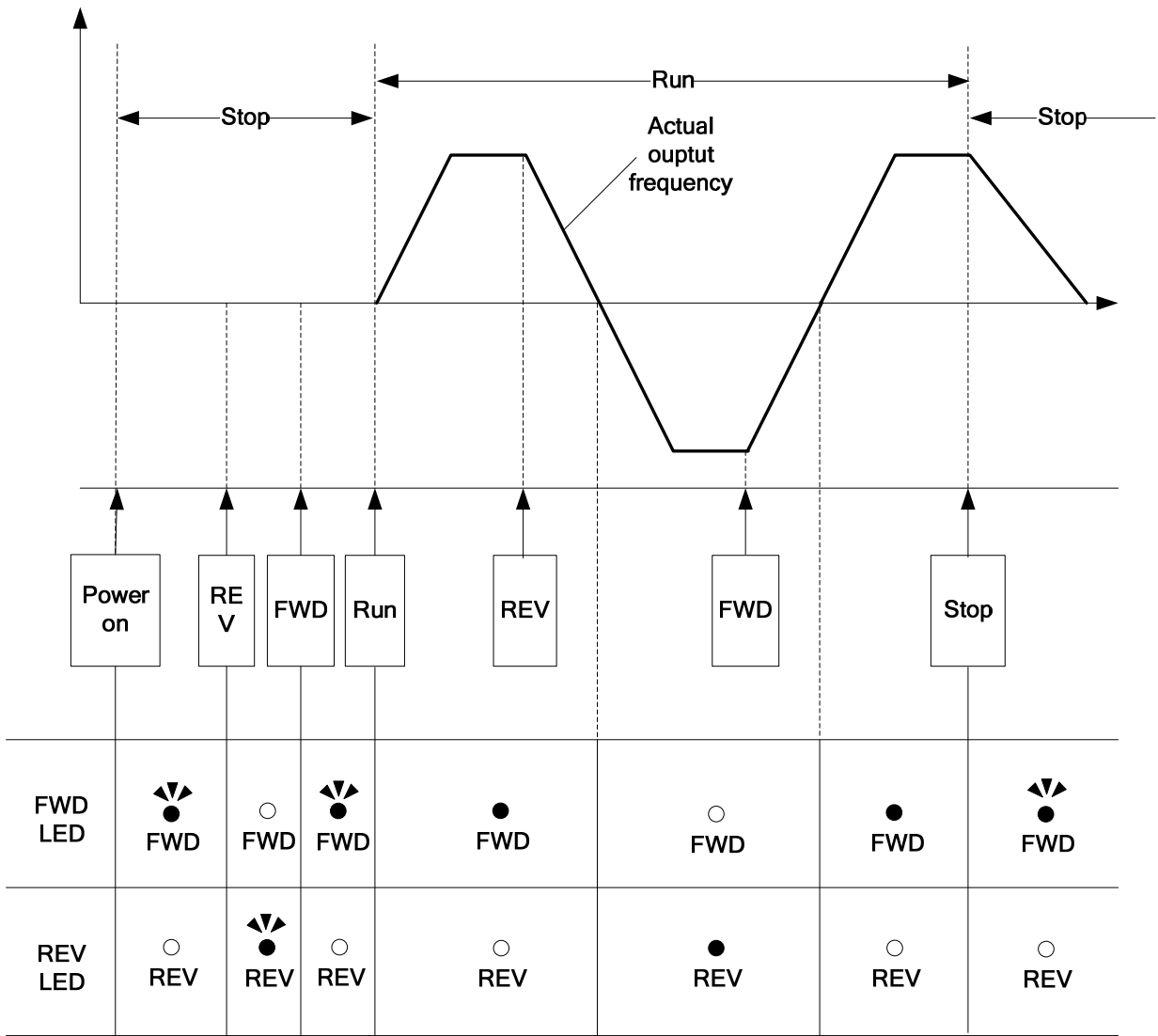

4.1.6 LCD keypad

LCD display (JN5-OP-A02) built-in internal memory can upload or download from one inverter to another one, please refer the functions of LCD keypad.



LED indicators for inverter status

- FAULT : LED on when a fault or alarm is active.
- FWD : LED on when inverter is running or forward
- REV : LED on when inverter is running or reverse
- SEQ : LED on when run command is from the external control or communication
- REF : LED on when frequency reference command is from external control or communication

LCD display (8 lines x 25 letters)

- ⊙ Display the monitoring value and parameter setting
- ⊙ Mode display (display on upper left of screen)

Monitor : Displayed at drive mode

Group : Displayed at mode setting

PARA : Displayed at parameter setting mode

Edit : Displayed at edit or auto-tune mode

Function keys (please refer to LED keypad)

Figure 4.1.6.1 LCD display

4.1.8 Monitoring Mode

In monitor mode inverter signals can be monitored such as output frequency, output current and output voltage, etc...) as well as fault information and fault trace. See Fig.4.1.8.1.

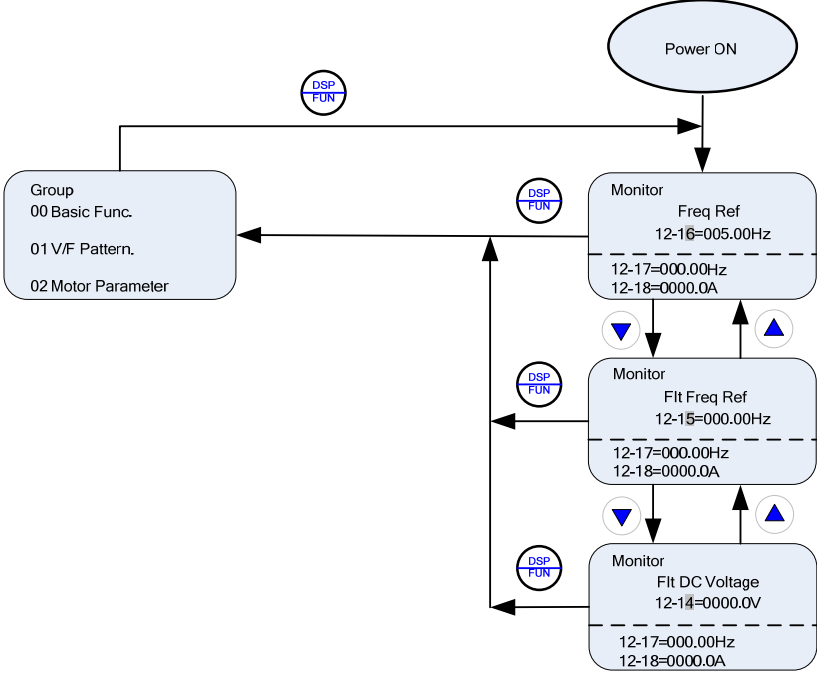

Fig.4.1.8.1 Monitoring Mode

4.1.9 Programming Mode

In programming mode inverter can be read or changed. Please refer Fig.4.1.9.1 ◦

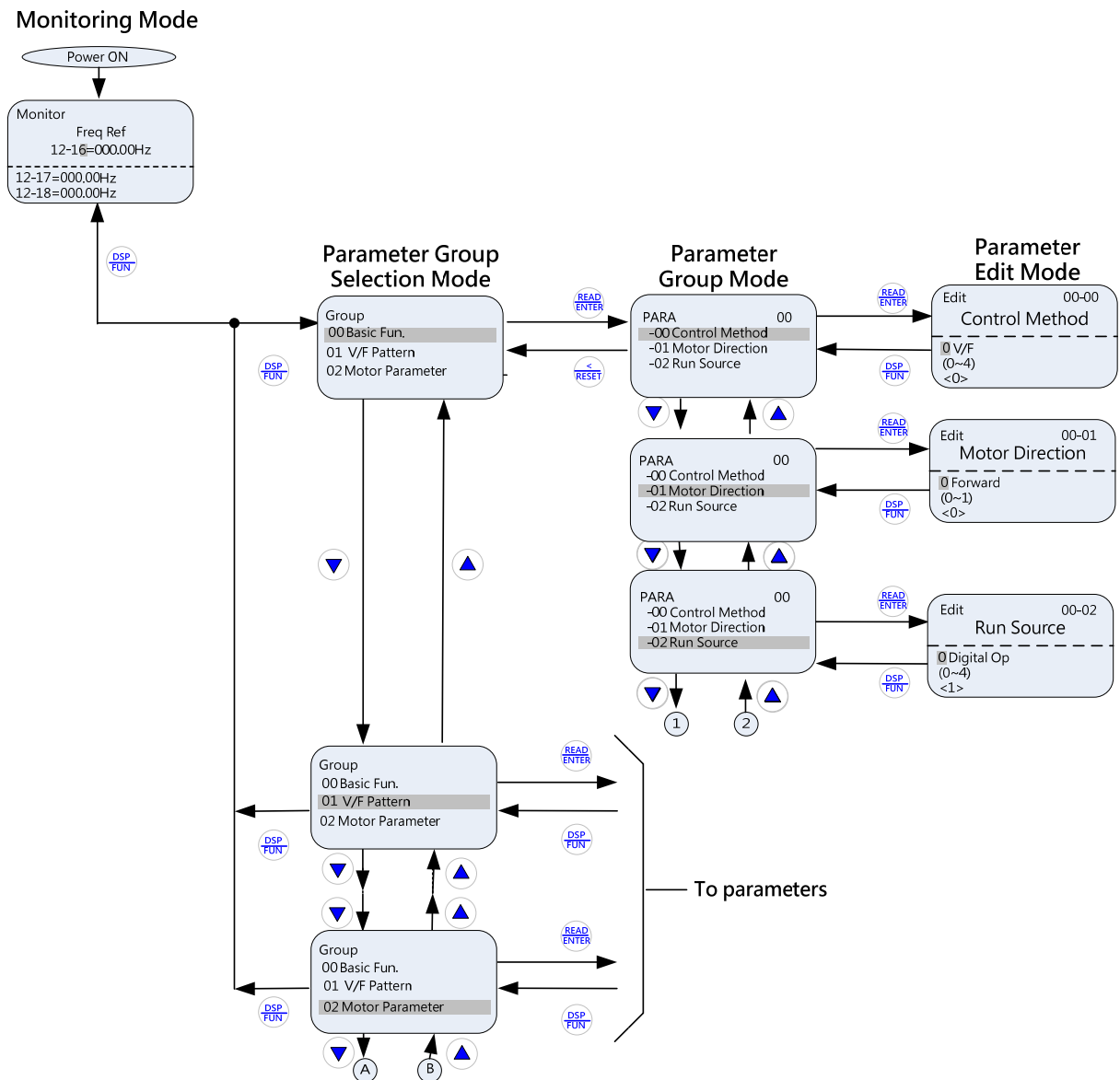

Fig.4.1.9.1 Programming Mode

Notes :

- (1) The parameters value can be changed from the edit screen with the function keys.
- (2) To save a parameter press the READ/ENTER key.
- (3) Refer to section 4.3 for parameter details.
- (4) Press the ▲ (up) or ▼ (down) key to scroll parameter groups or parameter list.

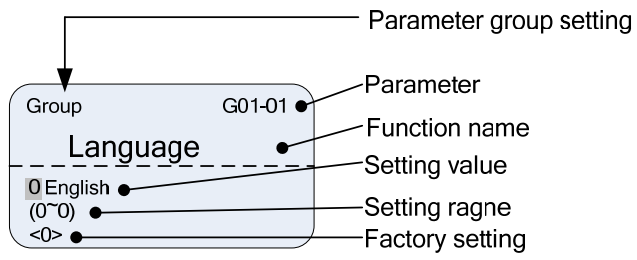

Fig.4.1.9.2 Parameter group setting

- Use ▲(up)/▼(down) key or <(left) key to change the parameter setting value, when you press READ/ENTER key, setting value will be saved and then display will flash again after a few seconds.

4.1.10 Auto-tune mode

In the auto-tune mode, motor parameters can be calculated and set automatically based on the selected control mode. See Fig.4.1.10.1 for keypad navigation.

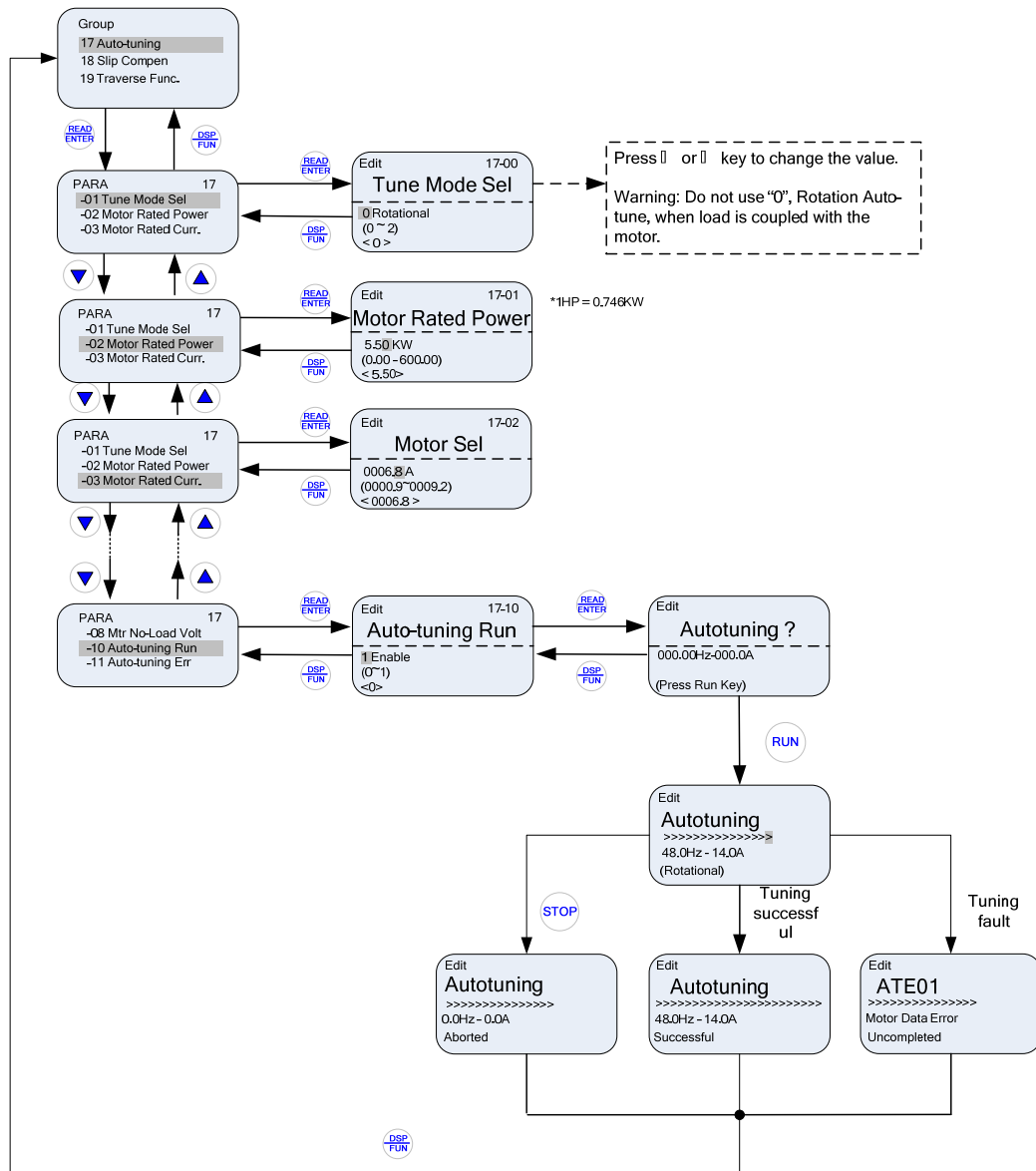

Fig.4.1.10.1 Auto-tune Mode

Notes :

- (1) Use the up and down keys to scroll through the auto-tuning parameter list. Depending on the selected control mode in parameter 00-00, part of auto-tuning parameters will not be accessible. (Refer to the Auto-tuning Group 17 parameters).
- (2) After entering the motor nameplate rated output power (17-01), rated current (17-02), rated voltage (17-03), rated frequency (17-04), rated speed (17-05) and number of motor poles (17-06), select the automatic tuning mode and press the RUN key to perform the auto-tuning operation. When auto-tuning is successful the calculated motor parameters will be saved into parameter group 02 (motor parameter).
- (3) When inverter executes auto-tune function :
 - (a) (Rotational) will be displayed during rotational auto-tuning (17-00=0) and the motor will rotate during auto-tuning. Ensure that it is safe to operate the motor before pressing the RUN key.
 - (b) (Stationary) will be displayed during stationary auto-tuning (17-00=1), the motor shaft does not rotate.
 - (c) (R1 Tuning) will be displayed during stationary auto-tuning (17-00=2), the motor shaft does not rotate.

- (d) The RUN LED (in the upper left corner of the RUN key) will be lit during auto-tuning.
 - (e) The LCD display shows ">>>" or "Atund" during the auto-tuning process.
- (4) Press the STOP key on the keypad to abort the auto-tuning operation °
 - (5) In case of an auto-tuning fault, a fault message and the uncompleted message are displayed on the keypad. The RUN LED will be flashing and the motor will coast to stop. (Refer to section 10.4 for the Auto-tuning Faults.) The auto-tuning fault can be cleared by pressing the RESET key after which the keypad displays the auto-tuning mode again.
 - (6) Upon successful completion of an auto-tune, the RUN LED will turn off. Press the DSP/FUN key to return to the main menu to select the next operation. The auto-tuning procedure takes approximately 50 seconds.

4.2 Parameters

Parameter group	Group Name
Group 00	Basic Parameters
Group 01	V/F Control Parameters
Group 02	IM Motor Parameters
Group 03	External Digital Input and Output Parameters
Group 04	External Analog Input and Output Parameters
Group 05	Multi-Speed Parameters
Group 06	Automatic Program Operation Parameters
Group 07	Start /Stop Parameters
Group 08	Protection Parameters
Group 09	Communication Parameters
Group 10	PID Parameters
Group 11	Auxiliary Parameters
Group 12	Monitoring Parameters
Group 13	Maintenance Parameters
Group 14	PLC Parameters
Group 15	PLC Monitoring Parameters
Group 16	LCD Parameters
Group 17	Automatic Tuning Parameters
Group 18	Slip Compensation Parameters
Group 20	Speed Control Parameters
Group 21	Torque And Position Control Parameters
Group 22	PM Motor Parameters
Group 23	Constant Pressure PUMP Parameters

Parameter Attribute	
*1	Parameters can be changed during run operation.
*2	Reserved
*3	Parameter will not reset to default during a factory reset (initialization).
*4	Read-only parameter
*5	Parameter will be displayed in being coupled with the option card.
*6	Parameter will be displayed only in LED keypad.
*7	Parameter will be displayed only in LCD keypad.
*8	When 13-08 setting is changed, the value will be also changed.

Group 00 Basic Parameters

Code	Parameter Name	Setting Range	Default	Unit	Control mode			Attribute
					V/F	SLV	PM SLV	
00-00	Control Mode Selection	0 : V/F 2 : SLV 5 : PMSLV	0	-	<input type="radio"/>	<input type="radio"/>	<input type="radio"/>	*3
00-01	Motor's Rotation Direction	0 : Forward 1 : Reverse	0	-	<input type="radio"/>	<input type="radio"/>	<input type="radio"/>	*1
00-02	Main Run Command Source Selection	0 : Keypad 1 : External Terminal (Control Circuit) 2 : Communication Control (RS-485) 3 : PLC	1	-	<input type="radio"/>	<input type="radio"/>	<input type="radio"/>	
00-03	Alternative Run Command Selection	0 : Keypad 1 : External Terminal (Control Circuit) 2 : Communication Control (RS-485) 3 : PLC	0	-	<input type="radio"/>	<input type="radio"/>	<input type="radio"/>	
00-04	Operation Modes For External Terminals	0 : Forward/Stop-Reverse/Stop 1 : Run/Stop- Reverse/Forward 2 : 3 Wire Control Mode Run/Stop	0	-	<input type="radio"/>	<input type="radio"/>	<input type="radio"/>	
00-05	Main Frequency Command Source Selection	0 : UP/DOWN of Keypad 1 : Potentiometer on Keypad 2 : External AI1 Analog Signal Input 3 : External AI2 Analog Signal Input 4 : External Up/Down Frequency 5 : Communication Setting Frequency 6 : Reserved 7 : Pulse Input(*6)	2	-	<input type="radio"/>	<input type="radio"/>	<input type="radio"/>	
00-06	Alternative Frequency Command Source Selection	0 : UP/DOWN of Keypad 1 : Potentiometer on Keypad 2 : External AI1 Analog Signal Input 3 : External AI2 Analog Signal Input 4 : External Up/Down Frequency 5 : Communication Setting Frequency 6 : Reserved 7 : Pulse Input(*6)	0	-	<input type="radio"/>	<input type="radio"/>	<input type="radio"/>	
00-07	Main and Alternative Frequency Command Modes	0 : Main or Alternative Frequency 1 : Main Frequency+ Alternative Frequency	0	-	<input type="radio"/>	<input type="radio"/>	<input type="radio"/>	
00-08	Communication Frequency Command	0.00~599.00	0.00	Hz	<input type="radio"/>	<input type="radio"/>	<input type="radio"/>	*4
00-09	Frequency Command Save on Power Down	0 : Disable 1 : Enable	0	-	<input type="radio"/>	<input type="radio"/>	<input type="radio"/>	

Group 00 Basic Parameters

Code	Parameter Name	Setting Range	Default	Unit	Control mode			Attribute
					V/F	SLV	PM SLV	
00-10	Initial Frequency Selection (keypad mode)	0 : by Current Frequency Command 1 : by 0 Frequency Command 2 : by 00-11	0	-	O	O	O	
00-11	Initial Frequency Setpoint	0.00-599.00	50/60	Hz	O	O	O	*1
00-12	Frequency Upper Limit	0.01-599.00	0.0	Hz	O	O	O	
00-13	Frequency Lower Limit	0.00-599.00	0.0	Hz	O	O	O	
00-14	Acceleration Time 1	0.1~6000.0	*	s	O	O	O	*1
00-15	Deceleration Time 1	0.1~6000.0	*	s	O	O	O	*1
00-16	Acceleration Time 2	0.1~6000.0	*	s	O	O	O	*1
00-17	Deceleration Time 2	0.1~6000.0	*	s	O	O	O	*1
00-18	Jog Frequency	0.00~599.00	2.00	Hz	O	O	O	*1
00-19	Jog Acceleration Time	0.1~0600.0	*	s	O	O	O	*1
00-20	Jog Deceleration Time	0.1~0600.0	*	s	O	O	O	*1
00-21	Acceleration Time 3	0.1~6000.0	*	s	O	X	X	*1
00-22	Deceleration Time 3	0.1~6000.0	*	s	O	X	X	*1
00-23	Acceleration Time 4	0.1~6000.0	*	s	O	X	X	*1
00-24	Deceleration Time 4	0.1~6000.0	*	s	O	X	X	*1
00-26	Emergency Stop Time	0.1~6000.0	5.0	s	O	O	O	
00-27	HD/ND Mode (F5/F6 Only)(***)	0 : HD (Heavy Duty Mode) 1 : ND (Normal Duty Mode)	0	-	O	X	X	*3
00-34	Language	0 : English 1 : Simplified Chinese 2 : Traditional Chinese 3 : Turkish	0	-	O	O	O	*7
00-35	Minimum Frequency Detection	0 : Alarm 1 : Keep Running At Lower Frequency	0	-	O	O	O	
00-36	PID Lower Frequency Selection	0 : Disable (Lower Frequency of PID Sleep Mode) 1 : Enable (0Hz of PID Sleep Mode)	0	-	O	O	O	

* : Refer to the following attachment 1.

*** : If parameter 00-27 is set to ND mode, group 02 motor 1 parameter will automatically adjust to more than 1 class of it.

If parameter 00-27 is set to HD mode, group 02 motor 1 parameter will automatically adjust to the same class of it.

It is suggested that parameter 00-27 be set first before motor performs auto-tuning because the parameter will make the motor parameter automatically be changed.

Group 01 V/F Control Parameters

Code	Parameter Name	Setting Range	Default	Unit	Control mode			Attribute
					V/F	SLV	PM SLV	
01-00	Volts/Hz Patterns	0~FF	F	-	O	X	X	*3
01-02	Maximum Output Frequency of Motor 1	4.8~599.0	50.0/60.0	Hz	O	O	X	*8
01-03	Maximum Output Voltage of Motor 1	200V : 0.1~255.0	230.0	V	O	X	X	*8
		400V : 0.2~510.0	400.0					
01-04	Middle Output Frequency 2 of Motor 1	0.0~599.0	0.0	Hz	O	X	X	
01-05	Middle Output Voltage 2 of Motor 1	200V : 0.0~255.0 400V : 0.0~510.0	0.0	V	O	X	X	*8
01-06	Middle Output Frequency 1 of Motor 1	0.0~599.0	2.5/3.0	Hz	O	X	X	*8
01-07	Middle Output Voltage 1 of Motor 1	200V : 0.0~255.0 400V : 0.0~510.0	KVA	V	O	X	X	*8
01-08	Minimum Output Frequency of Motor 1	0.0~599.0	V/F :	1.3/1.5	Hz	O	O	O
			SLV :	0.5/0.6				
			PMSLV :	10.0				
01-09	Minimum Output Voltage of Motor 1	200V : 0.0~255.0 400V : 0.0~510.0	KVA	V	O	X	X	*8
01-10	Torque Compensation Gain	0.0~2.0	0.5	-	O	X	X	*1
01-11	Selection of Torque Compensation Mode	0 : Mode 0 (Normal) 1 : Mode 1 (High Speed)	0	-	O	X	X	
01-12	Base Frequency of Motor 1	4.8~599.0	50.0/60.0	Hz	O	O	X	*8
01-13	Base Output Voltage of Motor 1	200V : 0.0~255.0	230.0	V	O	X	X	*8
		400V : 0.0~510.0	400.0					
01-14	Input Voltage Setting	200V : 55.0~255.0	230.0	V	O	O	O	*8
		400V : 10.0~510.0	400.0					
01-15	Torque Compensation Time	0~10000	200	ms	O	X	X	
01-16	Maximum Output Frequency of Motor 2	4.8~599.0	50.0/60.0	Hz	O	X	X	*8
01-17	Maximum Output Voltage of Motor 2	200V : 0.1~255.0	230.0	V	O	X	X	*8
		400V : 0.2~510.0	400.0					
01-18	Middle Output Frequency 2 of Motor 2	0.0~599.0	0.0	Hz	O	X	X	
01-19	Middle Output Voltage 2 of Motor 2	200V : 0.0~255.0 400V : 0.0~510.0	0.0	V	O	X	X	
01-20	Middle Output Frequency 1 of Motor 2	0.0~599.0	2.5/3.0	Hz	O	X	X	*8
01-21	Middle Output Voltage 1 of Motor 2	200V : 0.0~255.0 400V : 0.0~510.0	KVA	V	O	X	X	*8
01-22	Minimum Output Frequency of Motor 2	0.0~599.0	1.3/1.5	Hz	O	X	X	
01-23	Minimum Output Voltage of Motor 2	200V: 0.0~255.0 400V: 0.0~510.0	KVA	V	O	X	X	*8
01-24	Base Frequency of Motor 2	4.8~599.0	50.0/60.0	Hz	O	X	X	*8
01-25	Base Output Voltage of Motor 2	200V: 0.0~255.0	230.0	V	O	X	X	*8
		400V: 0.0~510.0	400.0					
01-26	V/F Curve Selection of Motor 2	0~FF	F	-	O	X	X	*3

Group 02 IM Motor Parameters

Code	Parameter Name	Setting Range	Default	Unit	Control mode			Attribute
					V/F	SLV	PM SLV	
02-00	No-Load Current of Motor1	0.01~600.00	KVA	A	O	X	X	
02-01	Rated Current of Motor1	Lower limit : 10% Inverter rated current (V/F) 25% Inverter rated current (SLV) Upper limit : Based on inverter capacity	KVA	A	O	O	X	
02-03	Rated Rotation Speed of Motor1	0~60000	KVA	RPM	O	O	X	*8
02-04	Rated Voltage of Motor1	200V: 50.0~240.0	230.0	V	O	O	X	*8
		400V: 100.0~480.0	400.0					
02-05	Rated Power of Motor1	0.01~600.00	KVA	kW	O	O	X	
02-06	Rated Frequency of Motor1	4.8~599.0	50.0/60.0	Hz	O	O	X	*8
02-07	Poles of Motor 1	2~16(Even)	4	Poles	O	O	X	
02-09	Excitation Current of Motor 1	15%~70% of motor rated current	KVA	%	X	O	X	
02-10	Core Saturation Coefficient 1	1~100	KVA	%	X	O	X	
02-11	Core Saturation Coefficient 2 of Motor 1	1~100	KVA	%	X	O	X	
02-12	Core Saturation Coefficient 3 of Motor 1	80~300	KVA	%	X	O	X	
02-13	Core loss of Motor 1	0.0~15.0	KVA	%	O	X	X	
02-15	Resistance Between Wires of Motor 1	1~60.000	KVA	Ω	O	O	X	
02-16	Rotor Resistance Gain of Motor 1	1~60.000	KVA	Ω	O	O	X	
02-17	Leakage Inductance of Motor 1	0.001~60.000	KVA	mH	O	O	X	
02-19	No-Load Voltage of Motor 1	200V : 50~240 400V : 100~480	-	V	X	O	X	*8
02-20	No-Load Current of Motor 2	0.01~600.00	KVA	A	O	X	X	
02-21	Rated Current of Motor 2	10%~200% of inverter rated current	KVA	A	O	X	X	
02-22	Rated Rotation Speed of Motor 2	0~60000	KVA	RPM	O	X	X	*8
02-23	Rated Voltage of Motor 2	200V : 50.0~240.0	230.0	V	O	X	X	*8
		400V : 100.0~480.0	400.0					
02-24	Rated Power of Motor 2	0.01~600.00	KVA	kW	O	X	X	
02-25	Rated Frequency of Motor 2	4.8~599.0	50.0/60.0	Hz	O	X	X	*8
02-26	Poles of Motor 2	2~16(Even)	4	Poles	O	X	X	
02-32	Resistance between Wires of Motor 2	0.001~60.000	KVA	Ω	O	X	X	
02-33	Proportion of Motor Leakage Inductance	0.1~15.0	KVA	%	X	O	X	
02-34	Slip Frequency of Motor	0.10~20.00	KVA	Hz	X	O	X	

Group 03 External Digital Input and Output Parameters

Code	Parameter Name	Setting Range	Default	Unit	Control mode			Attribute
					V/F	SLV	PM SLV	
03-00	Multifunction Input Terminal S1	0 : Forward/Stop Command	0	-	<input type="checkbox"/>	<input type="checkbox"/>	<input type="checkbox"/>	
		1 : Reverse/Stop Command			<input type="checkbox"/>	<input type="checkbox"/>	<input type="checkbox"/>	
		2 : Multi-Speed/Position Setting Command 0			<input type="checkbox"/>	<input type="checkbox"/>	<input type="checkbox"/>	
		3 : Multi-Speed/Position Setting Command 1			<input type="checkbox"/>	<input type="checkbox"/>	<input type="checkbox"/>	
		4 : Multi-Speed/Position Setting Command 2			<input type="checkbox"/>	<input type="checkbox"/>	<input type="checkbox"/>	
		5 : Multi-Speed/Position Setting Command 3			<input type="checkbox"/>	<input type="checkbox"/>	<input type="checkbox"/>	
		6 : Forward Jog Run Command			<input type="checkbox"/>	<input type="checkbox"/>	<input type="checkbox"/>	
03-01	Multifunction Input Terminal S2	7 : Reverse Jog Run Command	1	-	<input type="checkbox"/>	<input type="checkbox"/>	<input type="checkbox"/>	
		8 : UP Frequency Increasing Command			<input type="checkbox"/>	<input type="checkbox"/>	<input type="checkbox"/>	
		9 : DOWN Frequency Decreasing Command			<input type="checkbox"/>	<input type="checkbox"/>	<input type="checkbox"/>	
		10 : Acceleration/ Deceleration Time Selection 2			<input type="checkbox"/>	<input type="checkbox"/>	<input type="checkbox"/>	
		11 : Inhibit Acceleration/ Deceleration Command			<input type="checkbox"/>	<input type="checkbox"/>	<input type="checkbox"/>	
		12 : Main/ Alternative Run Switch Function			<input type="checkbox"/>	<input type="checkbox"/>	<input type="checkbox"/>	
		13 : Main/ Alternative Frequency Switch Function			<input type="checkbox"/>	<input type="checkbox"/>	<input type="checkbox"/>	
03-02	Multifunction Input Terminal S3	14 : Emergency Stop (decelerate to zero and stop)	2	-	<input type="checkbox"/>	<input type="checkbox"/>	<input type="checkbox"/>	
		15 : External Baseblock Command (rotation freely to stop)			<input type="checkbox"/>	<input type="checkbox"/>	<input type="checkbox"/>	
		16 : PID Control Disable			<input type="checkbox"/>	<input type="checkbox"/>	<input type="checkbox"/>	
		17 : Fault Reset			<input type="checkbox"/>	<input type="checkbox"/>	<input type="checkbox"/>	
		18 : Auto Run Mode Enable			<input type="checkbox"/>	<input type="checkbox"/>	<input type="checkbox"/>	
		19 : Speed Search 1			<input type="checkbox"/>	<input type="checkbox"/>	<input checked="" type="checkbox"/>	
		20 : Energy Saving (V/F only)			<input type="checkbox"/>	<input checked="" type="checkbox"/>	<input checked="" type="checkbox"/>	
03-03	Multifunction Input Terminal S5	21 : Reset PID integral value to Zero	3	-	<input type="checkbox"/>	<input type="checkbox"/>	<input type="checkbox"/>	
		22 : Counter Input			<input type="checkbox"/>	<input type="checkbox"/>	<input type="checkbox"/>	
		23 : Counter reset			<input type="checkbox"/>	<input type="checkbox"/>	<input type="checkbox"/>	
		24 : PLC Input			<input type="checkbox"/>	<input type="checkbox"/>	<input type="checkbox"/>	
		25 : Pulse-In width measure(S3)			<input type="checkbox"/>	<input type="checkbox"/>	<input type="checkbox"/>	
		26 : Pulse-In frequency measure(S3)			<input type="checkbox"/>	<input type="checkbox"/>	<input type="checkbox"/>	
03-04	Multifunction Input Terminal S5	27 : Local/Romote selection	4	-	<input type="checkbox"/>	<input type="checkbox"/>	<input type="checkbox"/>	
		28 : Remote mode selection		-	<input type="checkbox"/>	<input type="checkbox"/>	<input type="checkbox"/>	
		29 : Jog Frequency Selection			<input type="checkbox"/>	<input type="checkbox"/>	<input type="checkbox"/>	
		33 : DC Braking		-	<input type="checkbox"/>	<input type="checkbox"/>	<input type="checkbox"/>	
03-05	Multifunction Input Terminal S6	34 : Speed Search 2	17	-	<input type="checkbox"/>	<input type="checkbox"/>	<input checked="" type="checkbox"/>	
		40 : Switching between Motor 1/Motor 2		-	<input type="checkbox"/>	<input type="checkbox"/>	<input checked="" type="checkbox"/>	
		41 : PID Sleep		-	<input type="checkbox"/>	<input type="checkbox"/>	<input type="checkbox"/>	
		47 : Fire mode			<input type="checkbox"/>	<input type="checkbox"/>	<input type="checkbox"/>	
		48 : KEB Acceleration			<input type="checkbox"/>	<input checked="" type="checkbox"/>	<input checked="" type="checkbox"/>	
		57 : Forced Frequency Run			<input type="checkbox"/>	<input type="checkbox"/>	<input type="checkbox"/>	
		63 : Switch to Constant Pressure 2			<input type="checkbox"/>	<input type="checkbox"/>	<input type="checkbox"/>	
		65 : Short-circuit braking		-	<input checked="" type="checkbox"/>	<input checked="" type="checkbox"/>	<input type="checkbox"/>	
		66 : PID Control Disable 2			<input type="checkbox"/>	<input type="checkbox"/>	<input type="checkbox"/>	
		68 : External Fault			<input type="checkbox"/>	<input type="checkbox"/>	<input type="checkbox"/>	
69 : External Overload		<input type="checkbox"/>	<input type="checkbox"/>	<input type="checkbox"/>				
03-06	Up/Down frequency step	0.00~5.00			<input type="checkbox"/>	<input type="checkbox"/>	<input type="checkbox"/>	

Group 03 External Digital Input and Output Parameters

Code	Parameter Name	Setting Range	Default	Unit	Control mode			Attribute
					V/F	SLV	PM SLV	
03-07	Up/Down Keep Frequency Status after Stop Command	0 : When Up/Down is used, the preset frequency is held as the inverter stops, and the UP/Down function is disabled 1 : When Up/Down is used, the preset frequency is reset to 0 Hz as the inverter stops. 2 : When Up/Down is used, the preset frequency is held as the inverter stops, and the UP/Down is available. 3 : When acceleration is used, the output frequency will be updated.	0	-	○	○	○	
03-08	S1 ~ S6 DI scan Time	1~200	1	ms	○	○	○	
03-09	Multi-Function Terminal S1~ S4 type selection	xxx0b : S1 A Contact, xxx1b : S1 B Contact xx0xb : S2 A Contact, xx1xb : S2 B Contact x0xxb : S3 A Contact, x1xxb : S3 B Contact 0xxxb : S4 A Contact, 1xxxb : S4 B Contact	0000b	-	○	○	○	
03-10	Multi-Function Terminal S5~ S6 type selection	xxx0b : S5A Contact, xxx1b : S5 B Contact xx0xb : S6 A Contact, xx1xb : S6 B Contact	0000b	-	○	○	○	
03-11	Relay (R1A-R1C) Output	0 : During Running	1	-	○	○	○	
		1 : Fault Contact Output			○	○	○	
		2 : Frequency Agree			○	○	○	
		3 : Setting Frequency Agree (03-13±03-14)			○	○	○	
		4 : Frequency Detection 1 (≥03-13+03-14)			○	○	○	
		5 : Frequency Detection 2 (≤ 03-13+03-14)			○	○	○	
		6 : Automatic Restart			○	○	○	
		7 : Momentary AC Power Loss			○	○	○	
		8 : Rapid Stop			○	○	○	
		9 : Base Block			○	○	○	
		10 : Motor Overload Protection (OL1)			○	○	○	
		11 : Drive Overload Protection (OL2)			○	○	○	
		12 : Over-torque Threshold Level (OT)			○	○	○	
		13 : Preset Output Current Reached			○	○	○	
		14 : Brake Control			○/	○	○	
		15 : PID Feedback Signal Loss			○	○	○	
		16 : Single pre-set count (3-22~23)			○	○	○	
		17 : Dual pre-set count (3-22~23)			○	○	○	
		18 : PLC Status Indicator (00-02)			○	○	○	
		19 : PLC control *			○	○	○	
20 : Zero Speed	○	○	○					
30 : Motor 2 Selection	○	X	X					
	37 : Detection Output of PID Feedback Loss			○	○	○		
	54 : Turn on short-circuit braking			X	X	○		

Group 03 External Digital Input and Output Parameters

Code	Parameter Name	Setting Range	Default	Unit	Control mode			Attribute
					V/F	SLV	PM SLV	
03-12	Relay (R2A-R2B)	55 : Low Current Detection	0	-	<input type="checkbox"/>	<input type="checkbox"/>	<input type="checkbox"/>	
	Output	59 : OH Detection			<input type="checkbox"/>	<input type="checkbox"/>	<input type="checkbox"/>	
03-13	Frequency Detection Level	0.0~599.0	0.0	Hz	<input type="checkbox"/>	<input type="checkbox"/>	<input type="checkbox"/>	
03-14	Frequency Detection Width	0.1~25.5	2.0	Hz	<input type="checkbox"/>	<input type="checkbox"/>	<input type="checkbox"/>	
03-15	Current Agree Level	0.1~999.9	0.1	A	<input type="checkbox"/>	<input type="checkbox"/>	<input type="checkbox"/>	
03-16	Delay Time of Current Agree Detection	0.1~10.0	0.1	s	<input type="checkbox"/>	<input type="checkbox"/>	<input type="checkbox"/>	
03-17	* Mechanical Braking Release Level	0.00~20.00	0.00	Hz	<input type="checkbox"/>	<input type="checkbox"/>	<input type="checkbox"/>	
03-18	* Mechanical Braking Level Set	0.00~20.00	0.00	Hz	<input type="checkbox"/>	<input type="checkbox"/>	<input type="checkbox"/>	
03-19	Relay (R1A-R2B) Type	xxx0b : R1 A Contact, xxx1b : R1 B Contact xx0xb : R2 A Contact, xx1xb : R2 B Contact	0000b	-	<input type="checkbox"/>	<input type="checkbox"/>	<input type="checkbox"/>	
03-20	Internal / External Multi-Function Input Terminal Selection	0~63	0		<input type="checkbox"/>	<input type="checkbox"/>	<input type="checkbox"/>	
03-21	Action To Set The Internal Multi-Function Input Terminals	0~63	0		<input type="checkbox"/>	<input type="checkbox"/>	<input type="checkbox"/>	
03-22	Pre-Set Count 1	0~9999	0		<input type="checkbox"/>	<input type="checkbox"/>	<input type="checkbox"/>	
03-23	Pre-Set Count 2	0~9999	0		<input type="checkbox"/>	<input type="checkbox"/>	<input type="checkbox"/>	
03-24	Output Under Current Detection	0 : Invalid 1 : Valid	0		<input type="checkbox"/>	<input type="checkbox"/>	<input type="checkbox"/>	
03-25	Output Under Current Detection Level	0~999.9	0.1	A	<input type="checkbox"/>	<input type="checkbox"/>	<input type="checkbox"/>	
03-26	Output Under Current Detection Delay Time	0.0~655.34s	0.01	s	<input type="checkbox"/>	<input type="checkbox"/>	<input type="checkbox"/>	
03-27	Pulse Frequency	50~25000	200	Hz	<input type="checkbox"/>	<input type="checkbox"/>	<input type="checkbox"/>	*1
03-28	Pulse Input Gain	0.0~1000.0	100.0	%	<input type="checkbox"/>	<input type="checkbox"/>	<input type="checkbox"/>	*1
03-30	Selection of Pulse Input	0 : General Pulse Input 1 : PWM 2 : PLC Encoder input	0	-	<input type="checkbox"/>	<input type="checkbox"/>	<input type="checkbox"/>	
03-33	Pulse Input Bias	-100.0~100.0	0.0	%	<input type="checkbox"/>	<input type="checkbox"/>	<input type="checkbox"/>	*1
03-34	Filter Time of Pulse Input	0.00~2.00	0.1	s	<input type="checkbox"/>	<input type="checkbox"/>	<input type="checkbox"/>	*1
03-53	Current Agree Level 2	0.0~999.9	0.1	A	<input type="checkbox"/>	<input type="checkbox"/>	<input type="checkbox"/>	

Group 03 External Digital Input and Output Parameters

Code	Parameter Name	Setting Range	Default	Unit	Control mode			Attribute
					V/F	SLV	PM SLV	
03-54	Emergency Stop Action	Run command disable and emergency Stop command disable. 0 : Restart after Inverter Stop 1 : Restart after External Reset Command	0	-	<input type="radio"/>	<input type="radio"/>	<input type="radio"/>	

* : If the maximum output frequency of motor is over 300HZ, the frequency resolution is changed to 0.1Hz

Group 04 Analog signal inputs / Analog output

Code	Parameter Name	Setting Range	Default	Unit	Control mode			Attribute
					V/F	SLV	PM SLV	
04-00	Analog Input Signal Type	0 : AI1 0~10V AI2 0~10V / 0~20mA 1 : AI1 0~10V AI2 4~20mA / 2~10V 2 : AI1 2~10V AI2 0~10V / 0~20mA 3 : AI1 2~10V AI2 4~20mA / 2~10V	1	-	<input type="radio"/>	<input type="radio"/>	<input type="radio"/>	
04-01	AI1 Signal Scanning and Filtering Time	0.00~2.00	0.03	s	<input type="radio"/>	<input type="radio"/>	<input type="radio"/>	
04-02	AI1 Gain	0.0~1000.0	100.0	%	<input type="radio"/>	<input type="radio"/>	<input type="radio"/>	*1
04-03	AI1 Bias	-100.0~100.0	0	%	<input type="radio"/>	<input type="radio"/>	<input type="radio"/>	*1
04-05	AI1 Slope	0 : Positive 1 : Negative	0	-	<input type="radio"/>	<input type="radio"/>	<input type="radio"/>	
04-06	AI2 Signal Scanning and Filtering Time	0.00~2.00	0.03	s	<input type="radio"/>	<input type="radio"/>	<input type="radio"/>	
04-07	AI2 Gain	0.0~1000.0	100.0	%	<input type="radio"/>	<input type="radio"/>	<input type="radio"/>	*1
04-08	AI2 Bias	-100.0~100.0	0	%	<input type="radio"/>	<input type="radio"/>	<input type="radio"/>	*1
04-10	AI2 Slope	0 : Positive 1 : Negative	0	-	<input type="radio"/>	<input type="radio"/>	<input type="radio"/>	
04-11	Analog Output (AO) Mode	0 : Output Frequency 1 : Frequency Command 2 : Output Voltage 3 : DC Bus Voltage 4 : Output Current	0	-	<input type="radio"/>	<input type="radio"/>	<input type="radio"/>	
04-12	AO Gain	0.0~1000.0	100.0	%	<input type="radio"/>	<input type="radio"/>	<input type="radio"/>	*1
04-13	AO Bias	-100.0~100.0	0	%	<input type="radio"/>	<input type="radio"/>	<input type="radio"/>	*1
04-15	AO Slope	0 : Positive 1 : Negative	0	-	<input type="radio"/>	<input type="radio"/>	<input type="radio"/>	
04-16	F-Gain	0 : Disable 1 : Enable	0	-	<input type="radio"/>	<input type="radio"/>	<input type="radio"/>	
04-20	AO Signal Scanning and Filtering Time	0.00~0.50	0.00	s	<input type="radio"/>	<input type="radio"/>	<input type="radio"/>	*1
04-22	AO voltage correction	0 : Disable 1 : Enable	0	-	<input type="radio"/>	<input type="radio"/>	<input type="radio"/>	

Group 05 Preset Frequency Selection

Code	Parameter Name	Setting Range	Default	Unit	Control mode			Attribute
					V/F	SLV	PM SLV	
05-00	Preset Speed Control Mode Selection	0 : Accel/Decel 1~4 apply to all speeds 1 : Individual Accel/Decel for each preset speed	0	-	<input type="radio"/>	<input type="radio"/>	<input type="radio"/>	
05-01	* Preset Speed 0	0.00~599.00	5.00	Hz	<input type="radio"/>	<input type="radio"/>	<input type="radio"/>	*1
05-02	* Preset Speed 1	0.00~599.00	5.00	Hz	<input type="radio"/>	<input type="radio"/>	<input type="radio"/>	*1
05-03	* Preset Speed 2	0.00~599.00	10.00	Hz	<input type="radio"/>	<input type="radio"/>	<input type="radio"/>	*1
05-04	* Preset Speed 3	0.00~599.00	20.00	Hz	<input type="radio"/>	<input type="radio"/>	<input type="radio"/>	*1
05-05	* Preset Speed 4	0.00~599.00	30.00	Hz	<input type="radio"/>	<input type="radio"/>	<input type="radio"/>	*1
05-06	* Preset Speed 5	0.00~599.00	40.00	Hz	<input type="radio"/>	<input type="radio"/>	<input type="radio"/>	*1
05-07	* Preset Speed 6	0.00~599.00	50.00	Hz	<input type="radio"/>	<input type="radio"/>	<input type="radio"/>	*1
05-08	* Preset Speed 7	0.00~599.00	50.00	Hz	<input type="radio"/>	<input type="radio"/>	<input type="radio"/>	*1
05-09	* Preset Speed 8	0.00~599.00	5.00	Hz	<input type="radio"/>	<input type="radio"/>	<input type="radio"/>	*1
05-10	* Preset Speed 9	0.00~599.00	5.00	Hz	<input type="radio"/>	<input type="radio"/>	<input type="radio"/>	*1
05-11	* Preset Speed 10	0.00~599.00	5.00	Hz	<input type="radio"/>	<input type="radio"/>	<input type="radio"/>	*1
05-12	* Preset Speed 11	0.00~599.00	5.00	Hz	<input type="radio"/>	<input type="radio"/>	<input type="radio"/>	*1
05-13	* Preset Speed 12	0.00~599.00	5.00	Hz	<input type="radio"/>	<input type="radio"/>	<input type="radio"/>	*1
05-14	* Preset Speed 13	0.00~599.00	5.00	Hz	<input type="radio"/>	<input type="radio"/>	<input type="radio"/>	*1
05-15	* Preset Speed 14	0.00~599.00	5.00	Hz	<input type="radio"/>	<input type="radio"/>	<input type="radio"/>	*1
05-16	* Preset Speed 15	0.00~599.00	5.00	Hz	<input type="radio"/>	<input type="radio"/>	<input type="radio"/>	*1
05-17	Preset Speed 0-Acc time	0.1~6000.0	10.0	s	<input type="radio"/>	<input type="radio"/>	<input type="radio"/>	
05-18	Preset Speed 0-Dec time	0.1~6000.0	10.0	s	<input type="radio"/>	<input type="radio"/>	<input type="radio"/>	
05-19	Preset Speed 1-Acc time	0.1~6000.0	10.0	s	<input type="radio"/>	<input type="radio"/>	<input type="radio"/>	
05-20	Preset Speed 1-Dec time	0.1~6000.0	10.0	s	<input type="radio"/>	<input type="radio"/>	<input type="radio"/>	
05-21	Preset Speed 2-Acc time	0.1~6000.0	10.0	s	<input type="radio"/>	<input type="radio"/>	<input type="radio"/>	
05-22	Preset Speed 2-Dec time	0.1~6000.0	10.0	s	<input type="radio"/>	<input type="radio"/>	<input type="radio"/>	
05-23	Preset Speed 3-Acc time	0.1~6000.0	10.0	s	<input type="radio"/>	<input type="radio"/>	<input type="radio"/>	
05-24	Preset Speed 3-Dec time	0.1~6000.0	10.0	s	<input type="radio"/>	<input type="radio"/>	<input type="radio"/>	
05-25	Preset Speed 4-Acc time	0.1~6000.0	10.0	s	<input type="radio"/>	<input type="radio"/>	<input type="radio"/>	
05-26	Preset Speed 4-Dec time	0.1~6000.0	10.0	s	<input type="radio"/>	<input type="radio"/>	<input type="radio"/>	
05-27	Preset Speed 5-Acc time	0.1~6000.0	10.0	s	<input type="radio"/>	<input type="radio"/>	<input type="radio"/>	
05-28	Preset Speed 5-Dec time	0.1~6000.0	10.0	s	<input type="radio"/>	<input type="radio"/>	<input type="radio"/>	
05-29	Preset Speed 6-Acc time	0.1~6000.0	10.0	s	<input type="radio"/>	<input type="radio"/>	<input type="radio"/>	
05-30	Preset Speed 6-Dec time	0.1~6000.0	10.0	s	<input type="radio"/>	<input type="radio"/>	<input type="radio"/>	
05-31	Preset Speed 7-Acc time	0.1~6000.0	10.0	s	<input type="radio"/>	<input type="radio"/>	<input type="radio"/>	
05-32	Preset Speed 7-Dec time	0.1~6000.0	10.0	s	<input type="radio"/>	<input type="radio"/>	<input type="radio"/>	

Group 05 Preset Frequency Selection

Code	Parameter Name	Setting Range	Default	Unit	Control mode			Attribute
					V/F	SLV	PM SLV	
05-33	Preset Speed 8-Acc time	0.1~6000.0	10.0	s	○	○	○	
05-34	Preset Speed 8-Dec time	0.1~6000.0	10.0	s	○	○	○	
05-35	Preset Speed 9-Acc time	0.1~6000.0	10.0	s	○	○	○	
05-36	Preset Speed 9-Dec time	0.1~6000.0	10.0	s	○	○	○	
05-37	Preset Speed 10-Acc time	0.1~6000.0	10.0	s	○	○	○	
05-38	Preset Speed 10-Dec time	0.1~6000.0	10.0	s	○	○	○	
05-39	Preset Speed 11-Acc time	0.1~6000.0	10.0	s	○	○	○	
05-40	Preset Speed 11-Dec time	0.1~6000.0	10.0	s	○	○	○	
05-41	Preset Speed 12-Acc time	0.1~6000.0	10.0	s	○	○	○	
05-42	Preset Speed 12-Dec time	0.1~6000.0	10.0	s	○	○	○	
05-43	Preset Speed 13-Acc time	0.1~6000.0	10.0	s	○	○	○	
05-44	Preset Speed 13-Dec time	0.1~6000.0	10.0	s	○	○	○	
05-45	Preset Speed 14-Acc time	0.1~6000.0	10.0	s	○	○	○	
05-46	Preset Speed 14-Dec time	0.1~6000.0	10.0	s	○	○	○	
05-47	Preset Speed 15-Acc time	0.1~6000.0	10.0	s	○	○	○	
05-48	Preset Speed 15-Dec time	0.1~6000.0	10.0	s	○	○	○	

* : If the maximum output frequency of motor is over 300HZ, the frequency resolution is changed to 0.1Hz

Group 06 Automatic Program Opera

Code	Parameter Name	Setting Range	Default	Unit	Control mode			Attribute
					V/F	SLV	PM SLV	
06-00	Auto Run Mode Selection	0 : Disabled 1 : Execute a single cycle operation mode. Restart speed is based on the previous stopped speed. 2 : Execute continuous cycle operation mode. Restart speed is based on the previous stopped speed. 3 : After the completion of a single cycle, the on-going operation speed is based on the speed of the last stage. Restart speed is based on the previous stopped speed. 4 : Execute a single cycle operation mode. Restart speed will be based on the speed of stage 0. 5 : Execute continuous cycle operation mode. Restart speed will be based on the speed of stage 0. 6 : After the completion of a single cycle, the on-going operation speed is based on the speed of the last stage. Restart speed is based on the speed of stage 0.	0	-	O	O	X	
06-01	* Frequency Setting of Operation-Stage 1	0.00~599.00	0.0	Hz	O	O	X	*1
06-02	* Frequency Setting of Operation-Stage 2	0.00~599.00	0.0	Hz	O	O	X	*1
06-03	* Frequency Setting of Operation-Stage 3	0.00~599.00	0.0	Hz	O	O	X	*1
06-04	* Frequency Setting of Operation-Stage 4	0.00~599.00	0.0	Hz	O	O	X	*1
06-05	* Frequency Setting of Operation-Stage 5	0.00~599.00	0.0	Hz	O	O	X	*1
06-06	* Frequency Setting of Operation-Stage 6	0.00~599.00	0.0	Hz	O	O	X	*1
06-07	* Frequency Setting of Operation-Stage 7	0.00~599.00	0.0	Hz	O	O	X	*1
06-08	* Frequency Setting of Operation-Stage 8	0.00~599.00	0.0	Hz	O	O	X	*1
06-09	* Frequency Setting of Operation-Stage 9	0.00~599.00	0.0	Hz	O	O	X	*1
06-10	* Frequency Setting of Operation-Stage 10	0.00~599.00	0.0	Hz	O	O	X	*1

Group 06 Automatic Program Opera

Code	Parameter Name	Setting Range	Default	Unit	Control mode			Attribute
					V/F	SLV	PM SLV	
06-11	* Frequency Setting of Operation-Stage 11	0.00~599.00	0.0	Hz	O	O	X	*1
06-12	* Frequency Setting of Operation-Stage 12	0.00~599.00	0.0	Hz	O	O	X	*1
06-13	* Frequency Setting of Operation-Stage 13	0.00~599.00	0.0	Hz	O	O	X	*1
06-14	* Frequency Setting of Operation-Stage 14	0.00~599.00	0.0	Hz	O	O	X	*1
06-15	* Frequency Setting of Operation-Stage 15	0.00~599.00	0.0	Hz	O	O	X	*1
06-16	Operation Time Setting of Speed-Stage 0	0.0~6000.0	0.0	s	O	O	X	*1
06-17	Operation Time Setting of Speed-Stage 1	0.0~6000.0	0.0	s	O	O	X	*1
06-18	Operation Time Setting of Speed-Stage 2	0.0~6000.0	0.0	s	O	O	X	*1
06-19	Operation Time Setting of Speed-Stage 3	0.0~6000.0	0.0	s	O	O	X	*1
06-20	Operation Time Setting of Speed-Stage 4	0.0~6000.0	0.0	s	O	O	X	*1
06-21	Operation Time Setting of Speed-Stage 5	0.0~6000.0	0.0	s	O	O	X	*1
06-22	Operation Time Setting of Speed-Stage 6	0.0~6000.0	0.0	s	O	O	X	*1
06-23	Operation Time Setting of Speed-Stage 7	0.0~6000.0	0.0	s	O	O	X	*1
06-24	Operation Time Setting of Speed-Stage 8	0.0~6000.0	0.0	s	O	O	X	*1
06-25	Operation Time Setting of Speed-Stage 9	0.0~6000.0	0.0	s	O	O	X	*1
06-26	Operation Time Setting of Speed-Stage 10	0.0~6000.0	0.0	s	O	O	X	*1
06-27	Operation Time Setting of Speed-Stage 11	0.0~6000.0	0.0	s	O	O	X	*1
06-28	Operation Time Setting of Speed-Stage 12	0.0~6000.0	0.0	s	O	O	X	*1
06-29	Operation Time Setting of Speed-Stage 13	0.0~6000.0	0.0	s	O	O	X	*1
06-30	Operation Time Setting of Speed-Stage 14	0.0~6000.0	0.0	s	O	O	X	*1
06-31	Operation Time Setting of Speed-Stage 15	0.0~6000.0	0.0	s	O	O	X	*1

Group 06 Automatic Program Opera

Code	Parameter Name	Setting Range	Default	Unit	Control mode			Attribute
					V/F	SLV	PM SLV	
06-32	Operation Direction Selection of Speed Stage 0	0 : Stop 1 : Forward 2 : Reverse	0	-	<input type="radio"/>	<input type="radio"/>	<input checked="" type="checkbox"/>	
06-33	Operation Direction Selection of Speed Stage 1	0 : Stop 1 : Forward 2 : Reverse	0	-	<input type="radio"/>	<input type="radio"/>	<input checked="" type="checkbox"/>	
06-34	Operation Direction Selection of Speed Stage 2	0 : Stop 1 : Forward 2 : Reverse	0	-	<input type="radio"/>	<input type="radio"/>	<input checked="" type="checkbox"/>	
06-35	Operation Direction Selection of Speed Stage 3	0 : Stop 1 : Forward 2 : Reverse	0	-	<input type="radio"/>	<input type="radio"/>	<input checked="" type="checkbox"/>	
06-36	Operation Direction Selection of Speed Stage 4	0 : Stop 1 : Forward 2 : Reverse	0	-	<input type="radio"/>	<input type="radio"/>	<input checked="" type="checkbox"/>	
06-37	Operation Direction Selection of Speed Stage 5	0 : Stop 1 : Forward 2 : Reverse	0	-	<input type="radio"/>	<input type="radio"/>	<input checked="" type="checkbox"/>	
06-38	Operation Direction Selection of Speed Stage 6	0 : Stop 1 : Forward 2 : Reverse	0	-	<input type="radio"/>	<input type="radio"/>	<input checked="" type="checkbox"/>	
06-39	Operation Direction Selection of Speed Stage 7	0 : Stop 1 : Forward 2 : Reverse	0	-	<input type="radio"/>	<input type="radio"/>	<input checked="" type="checkbox"/>	
06-40	Operation Direction Selection of Speed Stage 8	0 : Stop 1 : Forward 2 : Reverse	0	-	<input type="radio"/>	<input type="radio"/>	<input checked="" type="checkbox"/>	
06-41	Operation Direction Selection of Speed Stage 9	0 : Stop 1 : Forward 2 : Reverse	0	-	<input type="radio"/>	<input type="radio"/>	<input checked="" type="checkbox"/>	
06-42	Operation Direction Selection of Speed Stage 10	0 : Stop 1 : Forward 2 : Reverse	0	-	<input type="radio"/>	<input type="radio"/>	<input checked="" type="checkbox"/>	
06-43	Operation Direction Selection of Speed Stage 11	0 : Stop 1 : Forward 2 : Reverse	0	-	<input type="radio"/>	<input type="radio"/>	<input checked="" type="checkbox"/>	
06-44	Operation Direction Selection of Speed Stage 12	0 : Stop 1 : Forward 2 : Reverse	0	-	<input type="radio"/>	<input type="radio"/>	<input checked="" type="checkbox"/>	
06-45	Operation Direction Selection of Speed Stage 13	0 : Stop 1 : Forward 2 : Reverse	0	-	<input type="radio"/>	<input type="radio"/>	<input checked="" type="checkbox"/>	
06-46	Operation Direction Selection of Speed Stage 14	0 : Stop 1 : Forward 2 : Reverse	0	-	<input type="radio"/>	<input type="radio"/>	<input checked="" type="checkbox"/>	
06-47	Operation Direction Selection of Speed Stage 15	0 : Stop 1 : Forward 2 : Reverse	0	-	<input type="radio"/>	<input type="radio"/>	<input checked="" type="checkbox"/>	

* : If the maximum output frequency of motor is over 300HZ, the frequency resolution is changed to 0.1Hz

Group 07 Start/Stop Parameters

Code	Parameter Name	Setting Range	Default	Unit	Control mode			Attribute
					V/F	SLV	PM SLV	
07-00	Momentary Power Loss and Restart	0 : Disable 1 : Enable	0	-	<input type="radio"/>	<input type="radio"/>	<input checked="" type="checkbox"/>	
07-01	Fault Reset Time	0~7200	0	s	<input type="radio"/>	<input type="radio"/>	<input type="radio"/>	
07-02	Number of Auto Restart Attempts	0~10	0	-	<input type="radio"/>	<input type="radio"/>	<input type="radio"/>	
07-03	Reset Mode Setting	0 : Enable Reset Only when Run Command is Off 1 : Enable Reset when Run Command is On or Off	0	-	<input type="radio"/>	<input type="radio"/>	<input type="radio"/>	
07-04	Momentary Power Loss and Restart	0 : Enable Direct run on power up 1 : Disable Direct run on power up	1	-	<input type="radio"/>	<input type="radio"/>	<input type="radio"/>	
07-05	Delay-ON Timer	1.0~300.0	1.0	s	<input type="radio"/>	<input type="radio"/>	<input type="radio"/>	
07-06	DC Injection Braking Start Frequency	0.0~10.0	1.5	Hz	<input type="radio"/>	<input type="radio"/>	<input type="radio"/>	
07-07	DC Injection Braking Level (Current Mode)	0~100	50	%	<input type="radio"/>	<input type="radio"/>	<input type="radio"/>	
07-08	DC Injection Braking Time	0.00~100.00	0.50	s	<input type="radio"/>	<input type="radio"/>	<input type="radio"/>	
07-09	Stop Mode Selection	0 : Deceleration to Stop 1 : Coast to Stop 2 : DC Braking Stop in All Fields 3 : Coast to Stop with Timer	0	-	<input type="radio"/>	<input type="radio"/>	<input checked="" type="checkbox"/>	
07-10	Speed Search Mode Selection	0 : Normal Start 1 : Execute Speed Search Once 2 : Speed Search Start	0	-	<input type="radio"/>	<input type="radio"/>	<input type="radio"/>	
07-13	Low Voltage Detection Level	200V : 100~300	190	V	<input type="radio"/>	<input type="radio"/>	<input type="radio"/>	
		400V : 250~600	380					
07-15	DC Injection Brake Mode	0 : Current Mode 1 : Voltage Mode	1		<input type="radio"/>	<input type="radio"/>	<input type="radio"/>	
07-16	DC Injection Braking Time at Start	0.00~100.00	0.00	s	<input type="radio"/>	<input type="radio"/>	<input type="radio"/>	
07-18	Minimum Base block Time	0.1~5.0	KVA	s	<input type="radio"/>	<input type="radio"/>	<input type="radio"/>	
07-19	Speed Direction Search Operation Current	0~100	50	%	<input type="radio"/>	<input type="radio"/>	<input checked="" type="checkbox"/>	
07-20	Speed Search Operating Current	0~100	20	%	<input type="radio"/>	<input type="radio"/>	<input checked="" type="checkbox"/>	
07-21	Integral Time of Speed Searching	0.1~10.0	2.0	s	<input type="radio"/>	<input type="radio"/>	<input checked="" type="checkbox"/>	
07-22	Delay Time of Speed Searching	0.0~20.0	0.2	s	<input type="radio"/>	<input type="radio"/>	<input checked="" type="checkbox"/>	
07-23	Voltage Recovery Time	0.1~5.0	2.0	s	<input type="radio"/>	<input type="radio"/>	<input checked="" type="checkbox"/>	
07-24	Direction-Detection Speed Search Selection	0 : Invalid 1 : Valid	1	-	<input type="radio"/>	<input type="radio"/>	<input checked="" type="checkbox"/>	
07-25	Low Voltage Detection Time	0.00~1.00	0.02	s	<input type="radio"/>	<input type="radio"/>	<input type="radio"/>	

Group 07 Start/Stop Parameters

Code	Parameter Name	Setting Range	Default	Unit	Control mode			Attribute
					V/F	SLV	PM SLV	
07-26	Start-up Mode Selection of SLV Coast to Stop	0 : Start With Speed Search 1 : Normal Start	0	-	X	O	X	
07-27	Start Selection after Fault During SLV Mode	0 : Start With Speed Search 1 : Normal Start	0	-	X	O	X	
07-28	Start after External BaseBlock	0 : Start With Speed Search 1 : Normal Start	0	-	O	O	X	
07-29	Run Command Selection at the Action of DC Braking	0 : Not Allowable to Run 1 : Allowable to Run	0	-	O	X	X	
07-33	Start Frequency of Speed Search Selection	0 : Maximum Output Frequency 1 : Frequency Command	0	-	O	O	X	
07-34	Start Short-Circuit Braking Time	0.00~100.00	0.00	s	X	X	O	
07-35	Stop Short-Circuit Braking Time	0.00~100.00	0.50	s	X	X	O	
07-36	Short-Circuit Braking Current Limited	0.0~200.0	100.0	%	X	X	O	
07-37	Pre-Excitation Time	0.00~10.00	2.00	s	X	O	X	
07-38	Pre-Excitation Level	50~200	100	%	X	O	X	
07-39	Short-Circuit Braking Time of PM Motor Speed Search Function	0.00~100.00	0.00	s	X	X	O	
07-40	DC Injection Braking Time of PM Motor Speed Search Function	0.00~100.00	0.00	s	X	X	O	
07-45	STP2 function selection	0 : STP2 is enabled 1 : STP2 is disabled	0		O	O	O	

* : If the maximum output frequency of motor is over 300HZ, the frequency resolution is changed to 0.1Hz

Group 08 Protection Parameters

Code	Parameter Name	Setting Range	Default	Unit	Control mode			Attribute
					V/F	SLV	PM SLV	
08-00	Stall Prevention Function	xxx0b : Stall prevention is enabled in acceleration. xxx1b : Stall prevention is disabled in acceleration. xx0xb : Stall prevention is enabled in deceleration. xx1xb : Stall prevention is disabled in deceleration. x0xxb : Stall prevention is enabled in operation x1xxb : Stall prevention is disabled in operation 0xxxb : Stall prevention in operation is based on deceleration time of speed-stage 1. 1xxxb : Stall prevention in operation is based on deceleration time of speed-stage 2.	0000b	-	O	O	O	
08-01	Stall Prevention Level During Acceleration	20~200	HD:150 ND:120	%	O	O	O	
08-02	Stall Prevention Level During Deceleration	200V : 330V~410V 400V : 660V~820V	385V 770V	V	O	O	O	
08-03	Stall Prevention Level During Run	30~200	HD:160 ND:120	%	O	X	X	
08-05	Selection for Motor Overload Protection (OL1)	xxx0b : Overload Protection is disabled. xxx1b : Overload Protection is enabled. xx0xb : Cold Start of Motor Overload xx1xb : Hot Start of Motor Overload x0xxb : Standard Motor x1xxb : Inverter Duty Motor 0xxxb : Reserved 1xxxb : Reserved	0001b	-	O	O	O	
08-06	Start-up Mode of Overload Protection Operation (OL1)	0 : Stop Output after Overload Protection 1 : Continuous Operation after Overload Protection.	0	-	O	O	O	
08-07	Cooling Fan Control	0 : Start in High Temperature 1 : Start in Operation 2 : Always Run 3 : Stop Operation	1	-	O	O	O	
08-08	Auto Voltage Regulation (AVR)	0 : Enable 1 : Disable	0	-	O	O	O	
08-09	Selection of Input Phase Loss Protection	0 : Disable 1 : Enable	0	-	O	O	O	
08-10	Selection of Output Phase Loss Protection	0 : Disable 1 : Enable	0	-	O	O	O	
08-13	Selection of Over-Torque Detection	0 : Over-Torque Detection is Disabled. 1 : Start to Detect when Reaching the Set Frequency. 2 : Start to Detect when the Operation is Begun.	0	-	O	O	O	

Group 08 Protection Parameters

Code	Parameter Name	Setting Range	Default	Unit	Control mode			Attribute
					V/F	SLV	PM SLV	
08-14	Selection of Over-Torque Action	0 : Deceleration to Stop when Over Torque is Detected. 1 : Display Warning when Over Torque is Detected. Go on Operation. 2 : Coast to Stop when Over Torque is Detected	0	-	○	○	○	
08-15	Level of Over-Torque Detection	0~300	160	%	○	○	○	
08-16	Time of Over-Torque Detection	0.0~10.0	0.1	s	○	○	○	
08-21	Limit of Stall Prevention During Acceleration	1~100	50	%	○	○	○	
08-22	Stall Prevention Detection Time During Run	2~100	100	ms	○	○	○	
08-23	Ground Fault (GF) Selection	0 : Disable 1 : Enable	0	-	○	○	○	
08-24	Operation Selection of External Fault	0 : Deceleration to Stop 1 : Coast to Stop 2 : Continuous Operation	0	-	○	○	○	
08-25	Detection Selection of External Fault	0 : Immediately Detect When the Power is Supplied 1 : Start to Detect during Operation	0	-	○	○	○	
08-35	Motor Overheating Fault Selection	0 : Disable 1 : Deceleration to Stop 2 : Coast to Stop 3 : Keep Running	0	-	○	○	○	
08-36	PTC Input Filter Time Constant	0.00 ~ 5.00	2.00	s	○	○	○	
08-38	Delay Time of Fan Off	0~600	60	s	○	○	○	
08-39	Delay Time of Motor Overheat Protection	1~300	60	s	○	○	○	
08-40	Motor2 Acceleration Stall Prevention Level	20~200	HD: 150	%	○	○	X	
			ND: 120					
08-41	Motor2 Acceleration Stall Prevention Limit	1~100	50	%	○	○	X	
08-42	PTC Protection Level	0.1~10.0V	0.7	V	○	○	○	
08-43	PTC Restart Level	0.1~10.0V	0.3	V	○	○	○	
08-44	PTC Warning Level	0.1~10.0V	0.5	V	○	○	○	
08-46	Temperature Agree Level	0~254°C	0	°C	○	○	○	
08-47	Temperature Reset Level	0~254°C	0	°C	○	○	○	

Group 08 Protection Parameters

Code	Parameter Name	Setting Range	Default	Unit	Control mode			Attribute
					V/F	SLV	PM SLV	
08-48	Selection of Fire Mode	0 : Disable 1 : Enable	0		<input type="radio"/>	<input type="radio"/>	<input type="radio"/>	
08-49	Multi-Function Input Terminal Status of Fire Mode	0 : Reset after Power Off 1 : Reset after Terminal Removed	0		<input type="radio"/>	<input type="radio"/>	<input type="radio"/>	
08-50	Multi-Function Terminal Status of Fire Mode	xxx0b : S6 A Contact xxx1b : S6 B Contact	0000b	-	<input type="radio"/>	<input type="radio"/>	<input type="radio"/>	
08-51	Motor Speed Setting Source of Fire Mode	0 : Fire Mode Speed(08-52) 1 : PID Control 2 : AI2	0	-	<input type="radio"/>	<input type="radio"/>	<input type="radio"/>	
08-52	Motor Speed of Fire Mode	0.00~100.00	100.00	%	<input type="radio"/>	<input type="radio"/>	<input type="radio"/>	
08-53	PID Detection Level of Fire Mode	0~100	0	%	<input type="radio"/>	<input type="radio"/>	<input type="radio"/>	
08-54	Delay Time of Fire Mode PID Loss	0.0~10.0	0.0	s	<input type="radio"/>	<input type="radio"/>	<input type="radio"/>	
08-55	PID Feedback Loss Detection Selection of Fire Mode	0 : Keep Running 1 : Fire Mode Speed(08-52) 2 : Max. Output Frequency of Motor 1 (01-02)	0	-	<input type="radio"/>	<input type="radio"/>	<input type="radio"/>	
08-56	Detection Level of Fire Mode AI2 Signal	0~100	0	%	<input type="radio"/>	<input type="radio"/>	<input type="radio"/>	
08-57	Delay Time of Fire Mode AI2 Signal Loss	0.0~10.0	0.0	s	<input type="radio"/>	<input type="radio"/>	<input type="radio"/>	
08-58	Selection of Fire Mode AI2 Signal Loss	0 : Keep Running 1 : Fire Mode Speed(08-52) 2 : Maximun Output Frequency (01-02)	0	-	<input type="radio"/>	<input type="radio"/>	<input type="radio"/>	
08-59	Fire Mode Motor Direction	0 : Forward 1 : Reverse	0	-	<input type="radio"/>	<input type="radio"/>	<input type="radio"/>	
08-60	Fire Mode Password	00000~65534	0	-	<input type="radio"/>	<input type="radio"/>	<input type="radio"/>	

***STO function only be designed in EMC filter built-in models.

Group 09 Communication Parametes

Code	Parameter Name	Setting Range	Default	Unit	Control mode			Attribute
					V/F	SLV	PM SLV	
09-00	INV Communication Station Address	1~32	1	-	○	○	○	*3
09-01	Communication Mode Selection	0 : MODBUS 1 : BACnet 3 : PUMP in Parallel Connection	0		○	○	○	*3
09-02	Baud Rate Setting (bps)	2 : 4800 3 : 9600 4 : 19200 5 : 38400	4	-	○	○	○	*3
09-03	Stop Bit Selection	0 : 1 Stop Bit 1 : 2 Stop Bit	0	-	○	○	○	*3
09-04	Parity Selection	0 : No Parity 1 : Even Bit 2 : Odd Bit	0	-	○	○	○	*3
09-05	Communication Data Bit Selection	0 : 8 Bit Data 1 : 7 Bit Data	0	-	○	○	○	*3
09-06	Communication Error Detection Time	0.0~25.5	0.0	s	○	○	○	*3
09-07	Fault Stop Selection	0 : Deceleration to Stop By Deceleration Time 1 1 : Coast to Stop 2 : Deceleration to Stop By Deceleration Time 2 3 : Keep Operating	3	-	○	○	○	*3
09-08	Comm. Fault Tolerance Count	1~20	1	-	○	○	○	*3
09-09	Waiting Time	5~65	5	ms	○	○	○	*3
09-10	BACNET Device Instance Number	1~254	1		○	○	○	*3

*3 : Parameter group 09 will not be effected by factory setting. (13-08).

Group 10 PID Parameters

Code	Parameters	Setting Range	Default	Unit	Control Mode			Attribute
					V/F	SLV	PM SLV	
10-00	PID Target Value Source Setting	0 : Keypad given 1 : AI1 given 2 : AI2 given 3 : Communication given 4 : 10-02 given	1	-	○	○	○	
10-01	PID Feedback Value Source Setting	0 : Keypad given 1 : AI1 given 2 : AI2 given 3 : Communication given	2	-	○	○	○	
10-02	PID Target Value	0.00~100.00	0.00	%	○	○	○	*1
10-03	PID Control Mode	xxx0b : PID Disable xxx1b : PID Enable xx0xb : PID Positive Characteristic xx1xb : PID Negative Characteristic x0xxb : PID Error Value of D Control x1xxb : PID Feedback Value of D Control 0xxxb : PID Output 1xxxb : PID Output+Frequency Command	0000b	-	○	○	○	
10-04	Feedback Gain	0.01~10.00	1.00	-	○	○	○	*1
10-05	Proportional Gain (P)	0.00~10.00	1.00	-	○	○	○	*1
10-06	Integral Time (I)	0.00~100.00	1.00	s	○	○	○	*1
10-07	Differential Time (D)	0.00~10.00	0.00	s	○	○	○	*1
10-08	Primary Delay Filter Time	1~250	4	ms	○	○	○	*1
10-09	PID Bias	-100.0~100.0	0	%	○	○	○	*1
10-11	PID Feedback Loss Detection Selection	0 : Disable 1 : Warning 2 : Fault	0	-	○	○	○	*1
10-12	PID Feedback Loss Det. Lev.	0~100	0	%	○	○	○	
10-13	PID Feedback Loss Det. Time	0.0~25.5	1.0	s	○	○	○	
10-14	PID Integral Limit	0.0~100.0	100.0	%	○	○	○	*1
10-17	* Start Frequency of PID Sleep	0.00~599.00	0.00	Hz	○	○	○	
10-18	Delay Time of PID Sleep	0.0~255.5	0.0	s	○	○	○	
10-19	* Frequency of PID Waking up	0.00~599.00	0.00	Hz	○	○	○	
10-20	Delay Time of PID Waking up	0.0~255.5	0.0	s	○	○	○	
10-23	PID Output Limit	0.00~100.0	100.0	%	○	○	○	*1
10-24	PID Output Gain	0.0~25.0	1.0	-	○	○	○	
10-25	PID Reversal Output Selection	0 : No Allowing Reversal Output 1 : Allow Reversal Output	0	-	○	○	○	
10-26	PID Target Acceleration/ Deceleration Time	0.0~25.5	0.0	s	○	○	○	

Group 10 PID Parameters

Code	Parameters	Setting Range	Default	Unit	Control Mode			Attribute
					V/F	SLV	PM SLV	
10-27	PID Feedback Display Bias	-99.99~99.99	0	-	<input type="radio"/>	<input type="radio"/>	<input type="radio"/>	
10-29	PID Sleep Selection	0 : Disable 1 : Enable 2 : Set By DI	1	-	<input type="radio"/>	<input type="radio"/>	<input type="radio"/>	
10-30	Upper Limit of PID Target	0.0 ~ 100.0	100.0	%	<input type="radio"/>	<input type="radio"/>	<input type="radio"/>	
10-31	Lower Limit of PID Target	0.0 ~ 100.0	0.0	%	<input type="radio"/>	<input type="radio"/>	<input type="radio"/>	
10-33	Maximum Value of PID Feedback	1 ~ 10000	999	-	<input type="radio"/>	<input type="radio"/>	<input type="radio"/>	
10-34	PID Decimal Width	0 ~ 4	1		<input type="radio"/>	<input type="radio"/>	<input type="radio"/>	
10-35	PID Unit	0 : % 1 : FPM 2 : CFM 3 : SPI 4 : GPH 5 : GPM 6 : IN 7 : FT 8 : /s 9 : /m 10 : /h 11 : °F 12 : inW 13 : HP 14 : m/s 15 : MPM 16 : CMM 17 : W 18 : KW 19 : m 20 : °C 21 : RPM 22 : Bar 23 : Pa 24 : kPa	0		<input type="radio"/>	<input type="radio"/>	<input type="radio"/>	*7
10-39	* Output Frequency Setting of PID Disconnection	00.00~599.00	30.00	Hz	<input type="radio"/>	<input type="radio"/>	<input type="radio"/>	
10-40	Selection of PID Sleep Compensation Frequency	0 : Disable 1 : Enable	0	-	<input type="radio"/>	<input type="radio"/>	<input type="radio"/>	
10-47	Proportional Gain (P) of Fire Mode	0.00~10.00	1.00		<input type="radio"/>	<input type="radio"/>	<input type="radio"/>	*1
10-48	Integral Time (I) of Fire Mode	0.00~100.00	1.00	s	<input type="radio"/>	<input type="radio"/>	<input type="radio"/>	*1
10-49	Differential Time (D) of Fire Mode	0.00~10.00	0.00	s	<input type="radio"/>	<input type="radio"/>	<input type="radio"/>	*1

Group 11 Auxiliary Parameters

Code	Parameters	Setting Range	Default	Unit	Control Mode			Attribute
					V/F	SLV	PM SLV	
11-00	Direction Lock Selection	0 : Allow Forward and Reverse Rotation 1 : Only Allow Forward Rotation 2 : Only Allow Reverse Rotation	0	-	O	O	O	
11-01	Carrier frequency	0 : Carrier Output Frequency Tuning 1~16 : 1~16KHz	*	-	O	O	O	
11-02	Soft PWM Function Selection	0 : Disable 1 : Soft PWM	0	-	O	O	O	
11-03	Automatic carrier lowering selection	0 : Disable 1 : Enable	0	-	O	X	X	
11-04	S-curve Time Setting at the Start of Acceleration	0.00~2.50	0.20	s	O	O	O	
11-05	S-curve Time Setting at the Stop of Acceleration	0.00~2.50	0.20	s	O	O	O	
11-06	S-curve Time Setting at the Start of Deceleration	0.00~2.50	0.20	s	O	O	O	
11-07	S-curve Time Setting at the Stop of Deceleration	0.00~2.50	0.20	s	O	O	O	
11-08	Jump Frequency 1	0.0~599.0	0.0	Hz	O	O	O	
11-09	Jump Frequency 2	0.0~599.0	0.0	Hz	O	O	O	
11-10	Jump Frequency 3	0.0~599.0	0.0	Hz	O	O	O	
11-11	Jump Frequency Width	0.00 ~ 30.00	1.0	Hz	O	O	O	
11-12	Manual Energy Saving Gain (V/F)	0~100	80	%	O	X	X	
11-14	OV Prevention Selection	230V : 200V~400V	370		O	X	X	
		400V : 400V~800V	740					
11-17	Acceleration/Deceleration Gain	0.1~10.0	1		O	X	X	
11-18	Manual Energy Saving Frequency	0.0~599.0	0.0	Hz	O	X	X	
11-28	Frequency Gain of Over Voltage Prevention 2	1~200	100	%	O	X	X	
11-33	DC Voltage Filter Rise Amount	0.1~10.0	0.1	Vdc	O	X	X	
11-34	DC Voltage Filter Fall Amount	0.1~10.0	5.0	Vdc	O	X	X	*1
11-35	DC Voltage Filter Deadband Level	0.0~99.0	10.0	Vdc	O	X	X	*1
11-36	Frequency gain of OV Prevention	0.000~1.000	0.050	-	O	X	X	*1
11-37	Frequency limit of OV Prevention	*0.00~599.00	5.00	Hz	O	X	X	*1

Group 11 Auxiliary Parameters

Code	Parameters	Setting Range	Default	Unit	Control Mode			Attribute
					V/F	SLV	PM SLV	
11-38	Deceleration start voltage of OV prevention	200V: 200~400V	300	V	O	X	X	
		400V: 400~800V	700					
11-39	Deceleration end voltage of OV Prevention	200V: 300~400V	350	V	O	X	X	
		400V: 600~800V	750					
11-40	OV Prevention Selection	0~3	0		O	X	X	
11-47	KEB Deceleration Time	0.0~25.5	0.0	s	O	X	X	*1
11-48	KEB Detection Level	230V : 190~210	200V	V	O	X	X	
		400V : 380~420	400V					
11-55	STOP Key Selection	0 : Stop Key is Disabled when the Operation Command is not Provided by Operator. 1 : Stop Key is Enabled when the Operation Command is not Provided by Operator.	1	-	O	O	O	
11-59	Gain of Preventing Oscillation	0.00~2.50	*		O	X	X	
11-60	Upper Limit of Preventing Oscillation	0~100	*	%	O	X	X	
11-61	Time Parameter of Preventing Oscillation	0~100	0		O	X	X	
11-62	Selection of Preventing Oscillation	0 : Mode 1 1 : Mode 2 2 : Mode 3	1	-	O	X	X	
11-63	Strong Magnetic Selection	0 : Disable 1 : Enable	1	-	X	O	X	
11-69	Gain of Preventing Oscillation 2	0.00~200.00	5.00	%	O	X	X	
11-70	Upper Limit of Preventing Oscillation 2	0.01~100.00	5.00	%	O	X	X	
11-71	Time of Preventing Oscillation 2	0~30000	100	ms	O	X	X	
11-72	Switch Frequency 1 of Preventing Oscillation 2	0.01~300.00	30.00	Hz	O	X	X	
11-73	Switch Frequency 2 of Preventing Oscillation 2	0.01~300.00	50.00	Hz	O	X	X	

* If the maximum output frequency of motor is over 300HZ, the frequency resolution is changed to 0.1Hz

Note : The parameter of 11-01 can be changed during run operation, the range is 1~16KHz.

Group 12 Monitoring Parameters

Code	Parameters	Setting Range	Default	Unit	Control Mode			Attribute
					V/F	SLV	PM SLV	
12-00	Display Screen Selection (LED)	00000~88888 From the leftmost bit, it displays the screen when press DSP key in order. 0 : no display 1 : Output Current 2 : Output Voltage 3 : DC Bus Voltage 4 : Heatsink Temperature* 5 : PID Feedback 6 : AI1 Value 7 : AI2 Value 8 : Counter Value	00000	-	○	○	○	*1 *6
12-01	PID Feedback Display Mode (LED)	0 : Display the Feedback Value by Integer (xxx) 1 : Display the Feedback Value by the Value with One Decimal Place (xx.x) 2 : Display the Feedback Value by the Value with Two Decimal Places (x.xx)	0		○	○	○	*6
12-02	PID Feedback Display Unit Setting (LED)	0 : xxxxx (no unit) 1 : xxxPb (pressure) 2 : xxxFL (flow)	0		○	○	○	*6
12-03	Line Speed Display (LED)	0~60000	1500/ 1800	RPM	○	○	○	*1 *6
12-04	Modes of Line Speed Display (LED)	0 : Display Inverter Output Frequency 1 : Display Line Speed with integer (xxxxx) 2 : Display Line Speed with the First Decimal Place (xxxx.x) 3 : Display Line Speed with the Second Decimal Place (xxx.xx) 4 : Display Line Speed with the Third Decimal Place (xx.xxx)	0	-	○	○	○	*1 *6
12-05	Status Display of Digital Input & Output Terminal (LED/LCD)	LCD display is shown as below LED display is shown as below	-		○	○	○	*4

Group 12 Monitoring Parameters

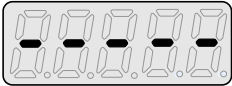
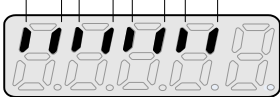
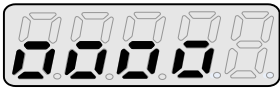
Code	Parameters	Setting Range	Default	Unit	Control Mode			Attribute
					V/F	SLV	PM SLV	
		no input  Correspondences to input and output S1 S2 S3 S4 S5 S6 S7 S8   R1 R2 DO1 PLC						
12-11	Output Current of Current Fault	Display the output current of current fault	-	A	<input type="radio"/>	<input type="radio"/>	<input type="radio"/>	*4
12-12	Output Voltage of Current Fault	Display the output voltage of current fault	-	V	<input type="radio"/>	<input type="radio"/>	<input type="radio"/>	*4
12-13	Output Frequency of Current Fault	Display the output frequency of current fault	-	Hz	<input type="radio"/>	<input type="radio"/>	<input type="radio"/>	*4
12-14	DC Voltage of Current Fault	Display the DC voltage of current fault	-	V	<input type="radio"/>	<input type="radio"/>	<input type="radio"/>	*4
12-15	Frequency Command of Current Fault	Display the frequency command of current fault	-	Hz	<input type="radio"/>	<input type="radio"/>	<input type="radio"/>	*4
12-16	Frequency Command	If LED enters this parameter, it only allows monitoring frequency command.	-	Hz	<input type="radio"/>	<input type="radio"/>	<input type="radio"/>	*4
12-17	Output Frequency	Display the current output frequency	-	Hz	<input type="radio"/>	<input type="radio"/>	<input type="radio"/>	*4
12-18	Output Current	Display the current output current	-	A	<input type="radio"/>	<input type="radio"/>	<input type="radio"/>	*4
12-19	Output Voltage	Display the current output voltage	-	V	<input type="radio"/>	<input type="radio"/>	<input type="radio"/>	*4
12-20	DC Voltage (Vdc)	Display the current DC voltage	-	V	<input type="radio"/>	<input type="radio"/>	<input type="radio"/>	*4
12-21	Output Power	Display the current output power	-	kW	<input type="radio"/>	<input type="radio"/>	<input type="radio"/>	*4
12-28	Motor Torque Current (Iq)	Display the current q-axis current		%	<input checked="" type="radio"/>	<input type="radio"/>	<input type="radio"/>	*4
12-29	Motor Excitation Current (Id)	Display the current d-axis current		%	<input checked="" type="radio"/>	<input type="radio"/>	<input type="radio"/>	*4
12-36	PID Input	Display input error of the PID controller (PID target value - PID feedback) (100% corresponds to the maximum frequency set by 01-02 or 01-16)		%	<input type="radio"/>	<input type="radio"/>	<input type="radio"/>	*4
12-37	PID Output	Display output of the PID controller (100% corresponds to the maximum frequency set by 01-02 or 01-16)		%	<input type="radio"/>	<input type="radio"/>	<input type="radio"/>	*4
12-38	PID Setting	Display the target value of the PID controller (100% corresponds to the maximum frequency set by 01-02 or 01-16)		%	<input type="radio"/>	<input type="radio"/>	<input type="radio"/>	*4

Group 12 Monitoring Parameters

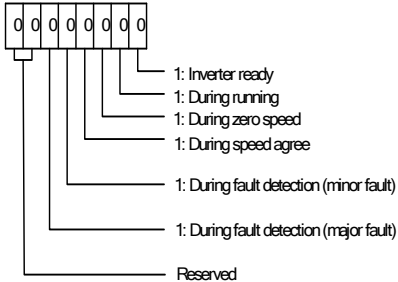
Code	Parameters	Setting Range	Default	Unit	Control Mode			Attribute
					V/F	SLV	PM SLV	
12-39	PID Feedback	Display the feedback value of the PID controller (100% corresponds to the maximum frequency set by 01-02 or 01-16)		%	○	○	○	*4
12-41	Heatsink Temperature*	Display the heatsink temperature of IGBT temperature**		°C	○	○	○	*4
12-43	Inverter Status				○	○	○	*4
12-74	Operation Pressure Setting	0.01~25.50	2.00	PSI	○	X	X	
12-75	Pressure Feedback Value	0.01~25.50	-	PSI	○	X	X	
12-82	Motor Loading	Display the loading current of motor	-	%	○	○	○	*4
12-83	Type of E510s	0 : IP20 NFS(without functional safety) 1 : IP20 FS(with functional safety) 2 : IP66 NFS(without functional safety) 3 : IP66 FS(with functional safety)	-	-	○	○	○	*4

Group 13 Maintenance Parameters

Code	Parameters	Setting Range	Default	Unit	Control Mode			Attribute
					V/F	SLV	PM SLV	
13-00	Inverter Capacity Selection	----	-	-	<input type="radio"/>	<input type="radio"/>	<input type="radio"/>	*3*4
13-01	Software Version	0.00-9.99	-	-	<input type="radio"/>	<input type="radio"/>	<input type="radio"/>	*3*4
13-02	Fault Record		0	-	<input type="radio"/>	<input type="radio"/>	<input type="radio"/>	*4
13-03	Cumulative Operation Hours 1	0~23	-	hr	<input type="radio"/>	<input type="radio"/>	<input type="radio"/>	*3*4
13-04	Cumulative Operation Hours 2	0~65534	-	day	<input type="radio"/>	<input type="radio"/>	<input type="radio"/>	*3*4
13-05	Selection of Cumulative Operation Time	0 : Cumulative time in power on 1 : Cumulative time in operation	0	-	<input type="radio"/>	<input type="radio"/>	<input type="radio"/>	*1
13-06	Parameters Locked	0 : Parameters are read-only except 13-06 and main frequency 1 : Reserved 2 : All Parameters are Writable	2	-	<input type="radio"/>	<input type="radio"/>	<input type="radio"/>	
13-07	Parameter Password Function	00000~65534	00000	-	<input type="radio"/>	<input type="radio"/>	<input type="radio"/>	
13-08	Restore Factory Setting	1 : 2 wire initialization (50Hz) (220V/380V) 2 : 2 wire initialization (60Hz) (220V/380V) 3 : 2 wire initialization (50Hz) (230V/400V) 4 : 2 wire initialization (60Hz) (230V/460V) 5 : 2 wire initialization (50Hz) (220V/415V) 6 : 2 wire initialization (60Hz) (230V/400V) 7 : 2 wire initialization (50Hz) (220V/440V) 8 : 2 wire initialization (60Hz) (220V/440V) 9 : 2 wire initialization (60Hz) (220V/380V) 10 : 2 wire initialization (60Hz) (220V/380V) 1112 : PLC initialization (RESET)	-	-	<input type="radio"/>	<input type="radio"/>	<input type="radio"/>	
13-09	Fault History Clearance Function	0 : No Clearing Fault History 1 : Clear Fault History	0					
13-10	Situation	0~9999	-	-	<input type="radio"/>	<input type="radio"/>	<input type="radio"/>	
13-21	Last Time Fault History	Exhibit last time fault history			<input type="radio"/>	<input type="radio"/>	<input type="radio"/>	
13-22	Previous Two Fault History	Exhibit previous two fault history			<input type="radio"/>	<input type="radio"/>	<input type="radio"/>	
13-23	Previous Three Fault History	Exhibit previous three fault history			<input type="radio"/>	<input type="radio"/>	<input type="radio"/>	
13-24	Previous Four Fault History	Exhibit previous four fault history			<input type="radio"/>	<input type="radio"/>	<input type="radio"/>	
13-25	Previous Five Fault History	Exhibit previous five fault history			<input type="radio"/>	<input type="radio"/>	<input type="radio"/>	
13-26	Previous Six Fault History	Exhibit previous six fault history		-	<input type="radio"/>	<input type="radio"/>	<input type="radio"/>	

Group 13 Maintenance Parameters

Code	Parameters	Setting Range	Default	Unit	Control Mode			Attribute
					V/F	SLV	PM SLV	
13-27	Previous Seven Fault History	Exhibit previous seven fault history		-	<input type="radio"/>	<input type="radio"/>	<input type="radio"/>	
13-28	Previous Eight Fault History	Exhibit previous eight fault history		-	<input type="radio"/>	<input type="radio"/>	<input type="radio"/>	
13-29	Previous Nine Fault History	Exhibit previous nine fault history		-	<input type="radio"/>	<input type="radio"/>	<input type="radio"/>	
13-30	Previous Ten Fault History	Exhibit previous ten fault history		-	<input type="radio"/>	<input type="radio"/>	<input type="radio"/>	
13-31	Previous Eleven Fault History	Exhibit previous eleven fault history		-	<input type="radio"/>	<input type="radio"/>	<input type="radio"/>	
13-32	Previous Twelve Fault History	Exhibit previous twelve fault history		-	<input type="radio"/>	<input type="radio"/>	<input type="radio"/>	
13-33	Previous Thirteen Fault History	Exhibit previous thirteen fault history		-	<input type="radio"/>	<input type="radio"/>	<input type="radio"/>	
13-34	Previous Fourteen Fault History	Exhibit previous fourteen fault history		-	<input type="radio"/>	<input type="radio"/>	<input type="radio"/>	
13-35	Previous Fifteen Fault History	Exhibit previous fifteen fault history		-	<input type="radio"/>	<input type="radio"/>	<input type="radio"/>	
13-36	Previous Sixteen Fault History	Exhibit previous sixteen fault history		-	<input type="radio"/>	<input type="radio"/>	<input type="radio"/>	
13-37	Previous Seventeen Fault History	Exhibit previous seventeen fault history		-	<input type="radio"/>	<input type="radio"/>	<input type="radio"/>	
13-38	Previous Eighteen Fault History	Exhibit previous eighteen fault history		-	<input type="radio"/>	<input type="radio"/>	<input type="radio"/>	
13-39	Previous Nineteen Fault History	Exhibit previous nineteen fault history		-	<input type="radio"/>	<input type="radio"/>	<input type="radio"/>	
13-40	Previous Twenty Fault History	Exhibit previous twenty fault history		-	<input type="radio"/>	<input type="radio"/>	<input type="radio"/>	
13-41	Previous Twenty one Fault History	Exhibit previous twenty one fault history		-	<input type="radio"/>	<input type="radio"/>	<input type="radio"/>	
13-42	Previous Twenty Two Fault History	Exhibit previous twenty two fault history		-	<input type="radio"/>	<input type="radio"/>	<input type="radio"/>	
13-43	Previous Twenty Three Fault History	Exhibit previous twenty three fault history		-	<input type="radio"/>	<input type="radio"/>	<input type="radio"/>	
13-44	Previous Twenty Four Fault History	Exhibit previous twenty four fault history		-	<input type="radio"/>	<input type="radio"/>	<input type="radio"/>	
13-45	Previous Twenty Five Fault History	Exhibit previous twenty five fault history		-	<input type="radio"/>	<input type="radio"/>	<input type="radio"/>	
13-46	Previous Twenty Six Fault History	Exhibit previous twenty six fault history		-	<input type="radio"/>	<input type="radio"/>	<input type="radio"/>	
13-47	Previous Twenty Seven Fault History	Exhibit previous twenty seven fault history		-	<input type="radio"/>	<input type="radio"/>	<input type="radio"/>	

Group 13 Maintenance Parameters

Code	Parameters	Setting Range	Default	Unit	Control Mode			Attribute
					V/F	SLV	PM SLV	
13-48	Previous Twenty Eight Fault History	Exhibit previous twenty eight fault history		-	<input type="radio"/>	<input type="radio"/>	<input type="radio"/>	
13-49	Previous Twenty Nine Fault History	Exhibit previous twenty nine fault history		-	<input type="radio"/>	<input type="radio"/>	<input type="radio"/>	
13-50	Previous Thirty Fault History	Exhibit previous thirty fault history		-	<input type="radio"/>	<input type="radio"/>	<input type="radio"/>	
13-51	Operation Time Clearance Function	0 : Do not clear operation time 1 : Clear operation time	0	-	<input type="radio"/>	<input type="radio"/>	<input type="radio"/>	*1

Group 14 PLC Setting Parameters

Code	Parameters	Setting Range	Default	Unit	Control Mode			Attribute
					V/F	SLV	PM SLV	
14-00	T1 Set Value 1	0~9999	0	-	○	○	○	
14-01	T1 Set Value 2 (Mode 7)	0~9999	0	-	○	○	○	
14-02	T2 Set Value 1	0~9999	0	-	○	○	○	
14-03	T2 Set Value 2 (Mode 7)	0~9999	0	-	○	○	○	
14-04	T3 Set Value 1	0~9999	0	-	○	○	○	
14-05	T3 Set Value 2 (Mode 7)	0~9999	0	-	○	○	○	
14-06	T4 Set Value 1	0~9999	0	-	○	○	○	
14-07	T4 Set Value 2 (Mode 7)	0~9999	0	-	○	○	○	
14-08	T5 Set Value 1	0~9999	0	-	○	○	○	
14-09	T5 Set Value 2 (Mode 7)	0~9999	0	-	○	○	○	
14-10	T6 Set Value 1	0~9999	0	-	○	○	○	
14-11	T6 Set Value 2 (Mode 7)	0~9999	0	-	○	○	○	
14-12	T7 Set Value 1	0~9999	0	-	○	○	○	
14-13	T7 Set Value 2 (Mode 7)	0~9999	0	-	○	○	○	
14-14	T8 Set Value 1	0~9999	0	-	○	○	○	
14-15	T8 Set Value 2 (Mode 7)	0~9999	0	-	○	○	○	
14-16	C1 Set Value	0~65534	0	-	○	○	○	
14-17	C2 Set Value	0~65534	0	-	○	○	○	
14-18	C3 Set Value	0~65534	0	-	○	○	○	
14-19	C4 Set Value	0~65534	0	-	○	○	○	
14-20	C5 Set Value	0~65534	0	-	○	○	○	
14-21	C6 Set Value	0~65534	0	-	○	○	○	
14-22	C7 Set Value	0~65534	0	-	○	○	○	
14-23	C8 Set Value	0~65534	0	-	○	○	○	
14-24	AS1 Set Value 1	0~65534	0	-	○	○	○	
14-25	AS1 Set Value 2	0~65534	0	-	○	○	○	
14-26	AS1 Set Value 3	0~65534	0	-	○	○	○	
14-27	AS2 Set Value 1	0~65534	0	-	○	○	○	
14-28	AS2 Set Value 2	0~65534	0	-	○	○	○	
14-29	AS2 Set Value 3	0~65534	0	-	○	○	○	
14-30	AS3 Set Value 1	0~65534	0	-	○	○	○	
14-31	AS3 Set Value 2	0~65534	0	-	○	○	○	
14-32	AS3 Set Value 3	0~65534	0	-	○	○	○	
14-33	AS4 Set Value 1	0~65534	0	-	○	○	○	
14-34	AS4 Set Value 2	0~65534	0	-	○	○	○	
14-35	AS4 Set Value 3	0~65534	0	-	○	○	○	
14-36	MD1 Set Value 1	0~65534	1	-	○	○	○	
14-37	MD1 Set Value 2	0~65534	1	-	○	○	○	

Group 14 PLC Setting Parameters

Code	Parameters	Setting Range	Default	Unit	Control Mode			Attribute
					V/F	SLV	PM SLV	
14-38	MD1 Set Value 3	1~65534	1	-	○	○	○	
14-39	MD2 Set Value 1	0~65534	1	-	○	○	○	
14-40	MD2 Set Value 2	0~65534	1	-	○	○	○	
14-41	MD2 Set Value 3	1~65534	1	-	○	○	○	
14-42	MD3 Set Value 1	0~65534	1	-	○	○	○	
14-43	MD3 Set Value 2	0~65534	1	-	○	○	○	
14-44	MD3 Set Value 3	1~65534	1	-	○	○	○	
14-45	MD4 Set Value 1	0~65534	1	-	○	○	○	
14-46	MD4 Set Value 2	0~65534	1	-	○	○	○	
14-47	MD4 Set Value 3	1~65534	1	-	○	○	○	

Group 15 PLC Monitoring Parameters

Code	Parameters	Setting Range	Default	Unit	Control Mode			Attribute
					V/F	SLV	PM SLV	
15-00	T1 Current Value1	0~9999	0	-	○	○	○	*4
15-01	T1 Current Value 2 (Mode7)	0~9999	0	-	○	○	○	*4
15-02	T2 Current Value 1	0~9999	0	-	○	○	○	*4
15-03	T2 Current Value 2 (Mode7)	0~9999	0	-	○	○	○	*4
15-04	T3 Current Value 1	0~9999	0	-	○	○	○	*4
15-05	T3 Current Value 2 (Mode7)	0~9999	0	-	○	○	○	*4
15-06	T4 Current Value 1	0~9999	0	-	○	○	○	*4
15-07	T4 Current Value 2 (Mode7)	0~9999	0	-	○	○	○	*4
15-08	T5 Current Value 1	0~9999	0	-	○	○	○	*4
15-09	T5 Current Value 2 (Mode7)	0~9999	0	-	○	○	○	*4
15-10	T6 Current Value 1	0~9999	0	-	○	○	○	*4
15-11	T6 Current Value 2 (Mode7)	0~9999	0	-	○	○	○	*4
15-12	T7 Current Value 1	0~9999	0	-	○	○	○	*4
15-13	T7 Current Value 2 (Mode7)	0~9999	0	-	○	○	○	*4
15-14	T8 Current Value 1	0~9999	0	-	○	○	○	*4
15-15	T8 Current Value 2 (Mode7)	0~9999	0	-	○	○	○	*4
15-16	C1 Current Value	0~65534	0	-	○	○	○	*4
15-17	C2 Current Value	0~65534	0	-	○	○	○	*4
15-18	C3 Current Value	0~65534	0	-	○	○	○	*4
15-19	C4 Current Value	0~65534	0	-	○	○	○	*4
15-20	C5 Current Value	0~65534	0	-	○	○	○	*4
15-21	C6 Current Value	0~65534	0	-	○	○	○	*4
15-22	C7 Current Value	0~65534	0	-	○	○	○	*4
15-23	C8 Current Value	0~65534	0	-	○	○	○	*4
15-24	AS1 Current Value	0~65534	0	-	○	○	○	*4
15-25	AS2 Current Value	0~65534	0	-	○	○	○	*4
15-26	AS3 Current Value	0~65534	0	-	○	○	○	*4
15-27	AS4 Current Value	0~65534	0	-	○	○	○	*4
15-28	MD1 Current Value	0~65534	0	-	○	○	○	*4
15-29	MD2 Current Value	0~65534	0	-	○	○	○	*4
15-30	MD3 Current Value	0~65534	0	-	○	○	○	*4
15-31	MD4 Current Value	0~65534	0	-	○	○	○	*4
15-32	TD Current Value	0~65534	0	-	○	○	○	*4

Group 16 LCD Function Parameters

Code	Parameters	Setting Range	Default	Unit	Control Mode			Attribute
					V/F	SLV	PM SLV	
16-00	Main Screen Monitoring	5~83 when using LCD to operate, the monitored item displays in the first line. (default: frequency command)	16	-	O	O	O	*1*7
16-01	Sub-Screen Monitoring 1	5~83 when using LCD to operate, the monitored item displays in the second line. (default: output frequency)	17	-	O	O	O	*1*7
16-02	Sub-Screen Monitoring 2	5~83 when using LCD to operate, the monitored item displays in the third line. (default is output current))	18	-	O	O	O	*1*7
16-03	Display Unit	0~39999 Determine the display way and unit of frequency command 0 : Frequency display unit is 0.01Hz 1 : Frequency display unit is 0.01% 2 : Frequency display unit is RPM. 3~39 : Reserved 40~9999 : Users specify the format, Input 0XXXX represents the display of XXXX at 100%. 10001~19999 : Users specify the format; Input 1XXXX represents the display of XXX.X at 100%. 20001~29999 : Users specify the format, Input 2XXXX represents the display of XX.XX at 100%. 30001~39999 : Users specify the format, Input 3XXXX represents the display of X.XXX at 100%.	0	-	O	O	O	*7
16-04	Engineering Unit	0 : No Unit 1 : FPM 2 : CFM 3 : PSI 4 : GPH 5 : GPM 6 : IN 7 : FT 8 : /s 9 : /m 10 : /h 11 : °F 12 : inW 13 : HP 14 : m/s 15 : MPM 16 : CMM	0	-	O	O	O	*7

Group 16 LCD Function Parameters

Code	Parameters	Setting Range	Default	Unit	Control Mode			Attribute
					V/F	SLV	PM SLV	
		17 : W 18 : kW 19 : m 20 : °C 21 : RPM 22 : Bar 23 : Pa 24 : kPa						
16-05	LCD Backlight	0~7	5	-	○	○	○	*1*7
16-07	Copy Function Selection	0 : Do not copy parameters 1 : Read inverter parameters and save them to the operator. 2 : Write the operator parameters to inverter. 3 : Compare parameters of inverter and operator.	0	-	○	○	○	*7
16-08	Selection of Allowing Reading	0 : Do not allow to read inverter parameters or save them to the operator. 1 : Allow to read inverter parameters and save to the operator.	0	-	○	○	○	*7
16-09	Selection of Operator Removed (LCD)	0 : Keep operating when LCD operator is removed. 1 : Display fault when LCD operator is removed	0	-	○	○	○	*1*7

Group 17 Automatic Tuning Parameters

Code	Parameter Name	Setting Range	Default	Unit	Control Mode			Attribute
					V/F	SLV	PM SLV	
17-00	Mode Selection of Automatic Tuning*	0 : Rotation Auto-tuning 1 : Static Auto-tuning 2 : Stator Resistance Measurement 3 : Reserved 4 : Loop Tuning 5 : Rotation Auto-tuning Combination (item: 4+2+0) 6 : Static Auto-tuning Combination (item: 4+2+1)	V/F : 2 SLV : 6	-	O	O	X	
17-01	Motor Rated Output Power	0.00~600.00	KVA	kW	O	O	X	
17-02	Motor Rated Current	0.1~1200.0	KVA	A	O	O	X	
17-03	Motor Rated Voltage	200V : 50.0~240.0	220	V	O	O	X	
		400V : 100.0~480.0	440					
17-04	Motor Rated Frequency	4.8~599.0	60.0	Hz	O	O	X	
17-05	Motor Rotated Speed	0~24000	KVA	RPM	O	O	X	
17-06	Pole Number of Motor	2~16(Even)	4	Pole	O	O	X	
17-08	Motor no-load Voltage	200V : 50~240	KVA	V	O	O	X	
		400V : 100~480						
17-09	Motor Excitation Current	0.01~600.00	KVA	A	X	O	X	
17-10	Automatic Tuning Start	0 : Disable 1 : Enable	0	-	O	O	X	
17-11	Error History of Automatic Tuning	0 : No error 1 : Motor data error 2 : Stator resistance tuning error 3 : Leakage induction tuning error 4 : Rotor resistance tuning error 5 : Mutual induction tuning error 6 : DT Error 7 : Encoder error 8 : Motor's acceleration error 9 : Warning	0	-	O	O	X	
17-12	Proportion of Motor Leakage Inductance	0.1~15.0	KVA	%	X	O	X	
17-13	Motor Slip Frequency	0.10~20.00	KVA	Hz	X	O	X	
17-14	Selection of Rotation Auto-tuning	0: VF Rotation Auto-tuning 1: Vector Rotation Auto-tuning	0	-	O	O	X	

KVA : The default value of this parameter will be changed by different capacities of inverter

It is suggested that HD/ ND mode (00-27) be selected first before motor performs auto-tuning.

Note : The value of mode selection of automatic tuning is 6 (Static Auto-tuning Combination). When do auto-tuning with no-load motor, it is suggested to select 17-00=5 (Rotation Auto-tuning Combination)

Group 18 Slip Compensation Parameters

Code	Parameters	Setting Range	Default	Unit	Control mode			Attribute
					V/F	SLV	PM SLV	
18-00	Slip Compensation Gain at Low Speed.	0.00~2.50	VF : 0.00	-	O	O	X	*1
			SLV : ***					
18-01	Slip Compensation Gain at High Speed.	-1.00~1.00	0.0	-	O	O	X	*1
18-02	Slip Compensation Limit	0~250	200	%	O	X	X	
18-03	Slip Compensation Filter Time	0.0~10.0	1.0	s	O	X	X	
18-04	Regenerative Slip Compensation Selection	0 : Disable 1 : Enable	0	-	O	X	X	
18-05	FOC Delay Time	1~1000	100	ms	X	O	X	
18-06	FOC Gain	0.00~2.00	0.1	-	X	O	X	

*** : Refer to the following attachment 1

Group 20 Speed Control Parameters

Code	Parameters	Setting Range	Default	Unit	Control Mode			Attribute
					V/F	SLV	PM SLV	
20-00	ASR Gain 1	0.00~250.00	-	-	X	O	O	*1
20-01	ASR Integral Time 1	0.001~10.000	-	s	X	O	O	*1
20-02	ASR Gain 2	0.00~250.00	-	-	X	O	O	*1
20-03	ASR Integral Time 2	0.001~10.000	-	s	X	O	O	*1
20-04	ASR Integral Time Limit	0~300	200	%	X	O	O	
20-07	Selection of Acceleration and Deceleration of P/PI	0 : PI speed control will be enabled only in constant speed. For the speed acceleration and deceleration, only use P control 1 : Speed control is enabled either in acceleration or deceleration.	0	-	X	O	X	
20-08	ASR Delay Time	0.000~0.500	0.004	s	X	O	O	
20-09	Speed Observer Proportional (P) Gain1	0.00~2.55	0.61	-	X	O	X	*1
20-10	Speed Observer Integral(I) Time 1	0.01~10.00	0.05	s	X	O	X	*1
20-11	Speed Observer Proportional (P) Gain2	0.00~2.55	0.61	-	X	O	X	*1
20-12	Speed Observer Integral(I) Time 2	0.01~10.00	0.06	s	X	O	X	*1
20-13	Low-pass Filter Time Constant of Speed Feedback 1	1~1000	4	ms	X	O	X	
20-14	Low-pass Filter Time Constant of Speed Feedback 2	1~1000	30	ms	X	O	X	
20-15	ASR Gain Change Frequency 1	0.0~599.0	4.0	Hz	X	O	O	
20-16	ASR Gain Change Frequency 2	0.0~599.0	8.0	Hz	X	O	O	
20-17	Torque Compensation Gain at Low Speed	0.00~2.50	1.00	-	X	O	X	*1
20-18	Torque Compensation Gain at High Speed	-10~10	0	%	X	O	X	*1
20-33	Detection Level at Constant Speed	0.1~5.0	1.0		X	O	O	*1
20-34	Compensation Gain of Derating	0~25600	0		X	O	O	*1
20-35	Compensation Time of Derating	0~30000	100	ms	X	O	O	*1

Group 21 Torque And Position Control Parameters

Code	Parameters	Setting Range	Default	Unit	Control mode			Attribute
					V/F	SLV	PM SLV	
21-05	Positive Torque Limit	0~300	150	%	X	O	O	*1
21-06	Negative Torque Limit	0~300	150	%	X	O	O	*1
21-07	Forward Regenerative Torque Limit	0~300	150	%	X	O	O	*1
21-08	Reversal Regenerative Torque Limit	0~300	150	%	X	O	O	*1

Group 22 PM Motor Parameters

Code	Parameters	Setting Range	Default	Unit	Control Mode			Attribute
					V/F	SLV	PM SLV	
22-00	PM Motor Rated Power	0.00~600.00	KVA	kW	X	X	O	
22-02	PM Motor Rated Current	25%~200% inverter rated current	KVA	A	X	X	O	
22-03	PM Motor's Pole Number	2~96	8	Poles	X	X	O	
22-04	PM Motor's Rotation Speed	0~60000	1500	RPM	X	X	O	
22-05	PM Motor's Maximum Rotation Speed	0~60000	1500	RPM	X	X	O	
22-06	PM Motor Rated Frequency	4.8~599.0	75.0	Hz	X	X	O	
22-07	PM Motor Type Selection	0: SPM 1: IPM	0	-	X	X	O	
22-10	PM SLV Start Current	20% ~ 200% Motor Rated Current	50	%	X	X	O	
22-11	I/F Mode Start Frequency Switching Point	1.0 ~ 20.0	10.0	%	X	X	O	
22-14	Armature Resistance of PM Motor	0.001 ~ 30.000	1.000	Ω	X	X	O	
22-15	D-axis Inductance of PM Motor	0.01 ~ 300.00	10.00	mH	X	X	O	
22-16	Q-axis Inductance of PM Motor	0.01 ~ 300.00	10.00	mH	X	X	O	
22-18	Flux-Weakening Limit	0~100	0	%	X	X	O	
22-21	PM Motor Tuning	0 : PM Motor Tuning is not Active. 1 : Parameter Auto-tune Mode 1 2 : Parameter Auto-tune Mode 2	0	-	X	X	O	
22-22	Fault History of PM Motor Tuning	0 : None 1 : Static Magnetic Alignment Fault 5 : Loop Adjustment is Time Out 7 : Other Errors of Motor Tuning 9 : Current Abnormity Occurs when Loop Adjustment	0	-	X	X	O	*4
22-23	PMSLV acceleration time	0.1~10.0	1.0	Sec	X	X	O	
22-25	Detection Mode Selection of Initial Magnetic Pole	0 : Upon the angle before stopping 1 : Detection Mode 1 2 : Detection Mode 2	2	-	X	X	O	
22-26	Estimator Mode	0~1 (in PMSLV mode)	0	-	X	X	O	
22-27	Voltage Command of Mode 2	5~120 (22-25=2 or 22-26=1 is enabled)	50	%	X	X	O	
22-28	Divider Ratio of Mode 2	0~8 (22-25=2 or 22-26=1 is enabled)	2	-	X	X	O	
22-29	Flux-weakening Voltage Command Restriction	80~110 (related to parameter 22-18)	100	%	X	X	O	
22-34	IPM Estimator Gain	1~300.0	180		X	X	O	

Group 23 PUMP & HVAC Function Parameters

Code	Parameters	Setting Range	Default	Unit	Control Mode			Attribute
					V/F	SLV	PM SLV	
23-00	Function Selection	0: Disable 1: PUMP 2: HVAC 3: Compressor	0	-	O	X	X	
23-01	Setting of Single & Multiple Pumps and Master & Slave Machines	0: Single Pump 1: Master 2: Slave 1 3: Slave 2 4: Slave 3	0	-	O	X	X	
23-02	Operation Pressure Setting	0.10 ~ 650.00	2.00	PSI	O	X	X	
23-03	Maximum Pressure Setting of Pressure Transmitter	0.10 ~ 650.00	10.00	PSI	O	X	X	
23-04	Pump Pressure Command Source	0 : Set by 23-02 1 : Set by AI	0		O	X	X	
23-05	Display Mode Selection	0: Display of Target and Pressure Feedback 1: Target Pressure Only 2: Feedback Pressure Only	0		O	X	X	
23-06	Proportion Gain(P)	0.00~10.00	3.00	-	O	X	X	
23-07	Integral Time(I)	0.0~100.0	0.5	Sec	O	X	X	
23-08	Differential Time(D)	0.00~10.00	0.00	Sec	O	X	X	
23-09	Tolerance Range of Constant Pressure	0.01 ~ 650.00	0.5	PSI	O	X	X	
23-10	Sleep Frequency of Constant Pressure	0.00 ~ 599.00	30.00	Hz	O	X	X	
23-11	Sleep Time of Constant Pressure	0.0 ~ 255.5	0.0	Sec	O	X	X	
23-12	Maximun Presure Limit	0.00 ~ 650.00	5	PSI	O	X	X	
23-13	Warning Time of High Pressure	0.0 ~ 600.0	10.0	Sec	O	X	X	
23-14	Stop Time of High Pressure	0.0 ~ 600.0	20.0	Sec	O	X	X	
23-15	Minimum Pressure Limit	0.00 ~ 650.00	5	%/PSI	O	X	X	
23-16	Warning Time of Low Pressure	0.0 ~ 600.0	0.0	Sec	O	X	X	
23-17	Fault Stop Time of Low Pressure	0.0 ~ 600.0	0.0	Sec	O	X	X	

Group 23 PUMP & HVAC Function Parameters								
Code	Parameters	Setting Range	Default	Unit	Control Mode			Attribute
					V/F	SLV	PM SLV	
23-18	Time of Loss Pressure Detection	0.0 ~ 600.0	0.0	Sec	O	X	X	
23-19	Proportion of Loss Pressure Detection	0 ~ 100	0	%	O	X	X	
23-22	Slave Trip Frequency	0.00 ~ 599.00	45.00	Hz	O	X	X	
23-23	Direction of Water Pressure Detection	0: Upward Detection 1: Downward Detection	1	-	O	X	X	
23-24	Range of Water Pressure Detection	0.00 ~ 65.00	0.1	PSI	O	X	X	
23-25	Period of Water Pressure Detection	0.0 ~ 200.0	30.0	Sec	O	X	X	
23-26	Acceleration Time of Water Pressure Detection	0.1 ~ 6000.0	KVA	Sec	O	X	X	
23-27	Deceleration Time of Water Pressure Detection	0.1 ~ 6000.0	KVA	Sec	O	X	X	
23-28	Forced Run Command	0.00 ~ 599.00	0.00	Hz	O	X	X	
23-29	Switching Time of Water Pressure Detection	0 ~ 240	3	Hr/min	O	X	X	
23-30	Detection Time of Multiple Pumps in Parallel Running Start	0.0 ~ 30.0	5.0	Sec	O	X	X	
23-31	Synchronous Selection of Multiple Pumps in Parallel	0: Disable 1: Pressure Setting Run/Stop 2: Pressure Setting 3: Run/Stop	1		O	X	X	
23-34	Tolerance Range of Constant Pressure 2	0.01 ~ 650.00	0.5	PSI	O	X	X	
23-35	Selection of Multiple Pumps Shift Operation	0: No Function 1: Timer Alternately Selection 2: Sleep Stop Alternately Selection 3: Timer and Sleep Stop Alternately Selection 4: Multiple Pumps Test Mode	1		O	X	X	
23-37	Leakage Detection Time	0.0~100.0	0.0	Sec	O	X	X	
23-38	Pressure Variation of Leakage Detection Restart	0.01 ~ 65.00	0.1	PSI	O	X	X	
23-39	Pressure Tolerance Range of Leakage Detection Restart	0.01 ~ 650.00	0.5	PSI	O	X	X	

Group 23 PUMP & HVAC Function Parameters

Code	Parameters	Setting Range	Default	Unit	Control Mode			Attribute
					V/F	SLV	PM SLV	
23-71	Maximum Pressure Setting	0.10~650.00	10.00	PSI	○	X	X	
23-72	Switching Time of Alternation in Parallel	0: Hour 1: Minute	0		○	X	X	
23-73	Slave Wake-Up Selection	0: Disable 1: Enable	0		○	X	X	
23-74	High Pressure Setting	0: Disable 1: High Pressure Warning 2: High Pressure Warning or Error	2		○	○	○	
23-75	Low Pressure Setting	0: Disable 1: Low Pressure Warning 2: Low Pressure Warning or Error	0		○	○	○	
23-78	Selection of Loss Pressure Detection	0: Disable 1: Loss Pressure Warning 2: Low Pressure Error	0		○	○	○	

Attachment 1 : Different factory setting and maximum setting value of each models

Model	Frame	When 11-01 <= 8K, the maximum output of SLV mode (Hz)	When 11-01 > 8K, the maximum output of SLV mode (Hz)	Whether 12-41 displayed inverter temperature?	SLV initial value(18-00) (Low speed slip compensation)
2P5	1	150	150	YES	1.00
201					
202H3					
202H1	2	150	150	YES	1.00
203					
205					
208	3	150	150	YES	1.00
210					
215	4	110	110	YES	1.00
220					
225	5	100	80	YES	0.70
230	6	100	80	YES	0.70
240					
401	1	150	150	YES	1.00
402					
403	2	150	150	YES	1.00
405					
408	3	150	150	YES	1.00
410					
415					
420	4	110	110	YES	1.00
425		100	100		
430	5	100	80	YES	0.70
440	6	100	80	YES	0.70
450					
460					
475					

Model	Initial value of 21-05~21-08 (Torque limit)	Initial value of 20-08 (ASR filter time)	Initial value of 00-14~00-17 00-23~00-27	Factory setting of 11-01 in HD mode	The maximum value of 11-01 in HD mode (SLV control mode)	The maximum value of 11-01 in HD mode (Other control modes)
2P5	150%	0.001	10.0	5	16	16
201				5	16	16
202H3				5	16	16
202H1	150%	0.001	10.0	5	16	16
203				5	16	16
205				5	16	16
208	150%	0.001	10.0	5	16	16
210				5	16	16
215	150%	0.002	15.0	5	16	16
220				5	16	16
225	150%	0.002	20.0	5	8	12
230	150%	0.004	20.0	5	8	12
240				5	8	12
401	150%	0.001	10.0	5	16	16
402				5	16	16
403	150%	0.001	10.0	5	16	16
405				5	16	16
408	150%	0.001	10.0	5	16	16
410				5	16	16
415				5	16	16
420	150%	0.002	15.0	5	16	16
425				5	16	16
430	150%	0.002	20.0	5	8	16
440	150%	0.004	20.0	5	8	12
450				5	8	12
460				5	8	10
475				5	8	10

The function of Low Voltage Start :

Wiring diagram :

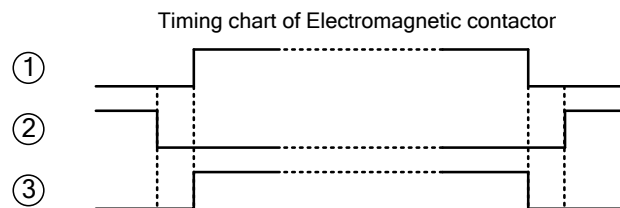
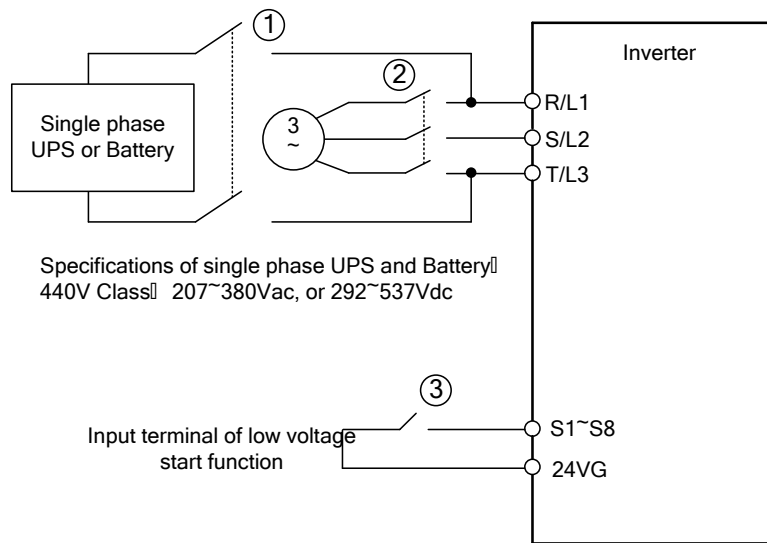

Contactor 1 and 3 will be enabled before the backup power is powered on, contactor 2 needs to keep opened. Contactor 3 will be opened after contactor 1. Contactor 1 and 3 should keep closed before backup power was removed and contactor 2 was closed.

Notes of Low Voltage Start function :

1. When low voltage start function is enabled (DI=62), cooling fan will not run, it can prevent the input voltage be dropped.
2. When low voltage start function is enabled, the function of input phase loss protection will be disabled.
3. When low voltage start function is enabled, the output frequency of motor will be based on 07-31.

Enhance the Riding Confort of Elevator

If there is any uncomfortable feeling during acceleration and deceleration period when you take the elevator. Please try to adjust the parameters as follows.

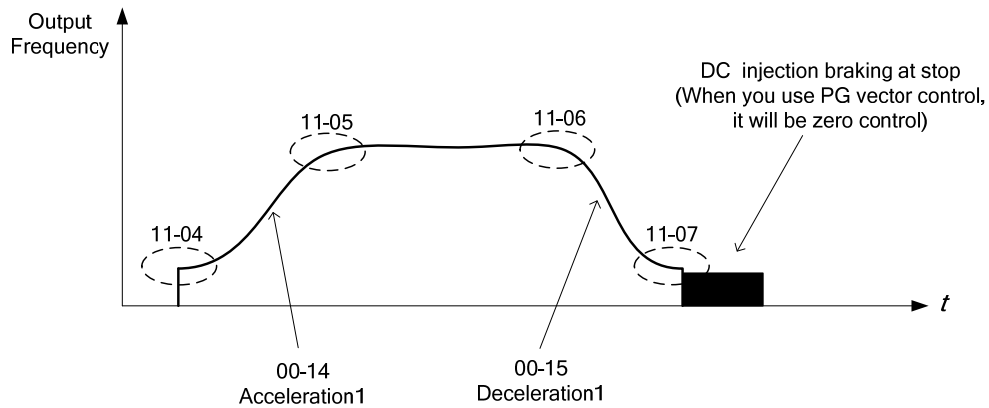

Notes :

During the deceleration of S curve, if the output frequency is lower than 01-08, the function of S curve will be stopped and then transfer to DC injection braking (Zero Speed Control).

Function of DC Injection Braking and Zero Speed Control.

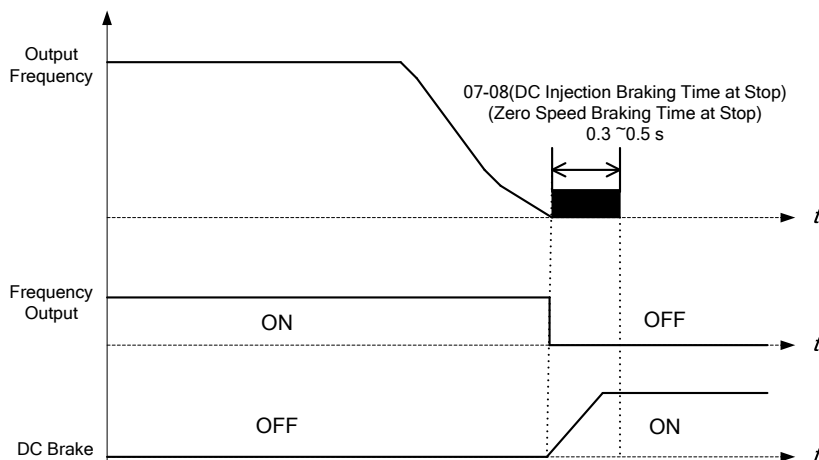

Note 1 :

According to the standards of European market, when the elevator is stop, the inverter and the motor has to be separated by contactor. For emergency situation, the inverter and the motor just can be separated by DC injection braking disabled and base block enabled (base block signal is ON)

Note 2 :

When inverter control is separated from motor control or DC injection braking control (Zero speed control). Sometimes, inverter will occur fault by pulse voltage.

Besides, when the contactor is installed between inverter and motor, please set 08-10=1 (Selection of output phase loss protection).

4.3 Description of parameters

Group 00 Basic Parameters

00-00	Control Mode Selection
Range	【0】 : V/F 【2】 : SLV 【5】 : PMSLV

➤ The inverter offers the following control modes :

00-00 Value	Mode	Information	Application
0	V/F	V/F Control without PG	General Purpose applications which do not require high precision speed control, auto-tuning is not required.
2	SLV	Sensorless Vector Control without PG	General Purpose Applications that require higher precision speed control and torque response without the use of an encoder.
5	PMSLV	Sensorless Current Vector Control without PG (for Permanent magnet motor)	Without PG Applications. Provide the requirements of high precision speed and torque

(1) 00-00=0 (V/F Mode)

- Select the required V/F curve (01-00) based on your motor and applications.
- Perform a stationary auto-tune (17-00=2), if the motor cable is longer than 50m (165ft), see parameter group 17 for details.

(2) 00-00=2 (SLV Control)

- Verify the inverter rating matches the motor rating. Perform rotational auto-tune to measure and store motor parameters for higher performance operation. Perform non-rotational auto-tune if it is not possible to rotate the motor during auto-tune. Refer to parameter group 17 for details on auto-tuning.

(3) 00-00=5 (PMSLV)

- PMSLV control mode has to connect motor, otherwise "CF08" error will be displayed.
- Verify the inverter rating matches the motor rating. Perform rotational auto-tune to measure and store motor parameters for higher performance operation.
- Perform auto-tuning before operation to enhance the performance of PMSLV mode. Refer to parameter 22-21 for the descriptions of PM motor tuning function.
- Select the appropriate motor rating and braking resistor based on your motor and applications. Please install the braking module in the models of 200V 30HP/ 400V 40HP or the above.

Note : Parameter 00-00 is excluded from initialization.

00- 01	Motor's Rotation Direction
Range	【0】 : Forward 【1】 : Reverse

- Use the FWD/REV key to change motor direction when Run Command Selection (00-02=0) is set to keypad control.

00- 02	Main Run Command Source Selection
Range	【0】 : Keypad 【1】 : External Terminal (Control Circuit) 【2】 : Communication Control (RS-485) 【3】 : PLC

(1) 00-02=0 : Keypad

- Use the keypad to start and stop the inverter and set direction with the forward / reverse key). Refer to section 4-1 for details on the keypad.

(2) 00-02=1 : External Terminal

- External terminals (00-04) can be used to start and stop the inverter and select motor direction.
- Please refer Fig. 4.3.1 for two wire control mode.
- Please refer Fig. 4.3.2 for three wire control mode.

(3) 00-02=2 : Communication

- Communication port (RS485) can be used to start and stop.
- Please refer parameter 09 for RS-422/485communication control.

(4) 00-02=3 : PLC

- Parameter 00-05 is invalid when the run and stop command is used by PLC function.
- PLC function can be stopped by RUN/STOP (keep pressing for 3 seconds) key of the keypad.

00- 03	Alternative RUN Command Selection
Range	【0】 : Keypad 【1】 : External terminal control 【2】 : Communication control 【3】 : PLC

(1) 00-03=0 : Keypad Control

- Use the keypad to start and stop the inverter and set direction with the forward / reverse key). Refer to section 4-1 for details on the keypad.

(2) 00-03=1 : External terminal control

- External terminals are used to start and stop the inverter and select motor direction.

Note : It is required to be used with multi-function digital input (12 : main and alternative run switch function).

00- 04	Alternative RUN Command Selection
Range	【0】 : Forward/Stop-Reverse/Stop 【1】 : Run/Stop- Reverse/ Forward 【2】 : 3 Wire Control Mode - Run/Stop

- 00-04 is valid when run command is set to external mode by 00- 02/00- 03 =1.
- Set 00-04= **【0/1】** first, before setting (03- 00~03- 05) to **【0】** or **【1】** .
- 00- 04= **【0】** , Set external terminals (03-00 to 03-05) function to 0 for FWD/Stop or Set to 1 for REV/Stop.
- 00- 04= **【1】** , Set external terminals (03-00 to 03-05) function to 0 for Run/Stop or Set to 1 for FWD/REV
- 00-04 = **【2】** Terminals S1, S2, S3 are used in a combination to enable 3 wire run/stop mode.
- Settings for 03-00, 03-01, 03-02 will not be effective. Please refer Fig.4.3.1 for 2 wire operation mode.

■ 2-wire operation

- For 2-wire operation set 03-00 (S1 terminal selection) to 0 and 03-01 (S2 terminal selection) to 1.

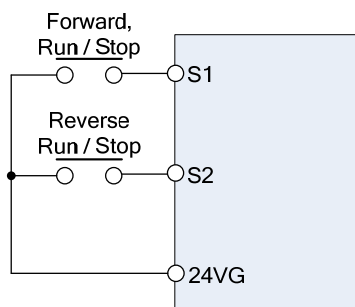

Figure 4.3.1 wiring example of 2-wire

■ 3-wire operation

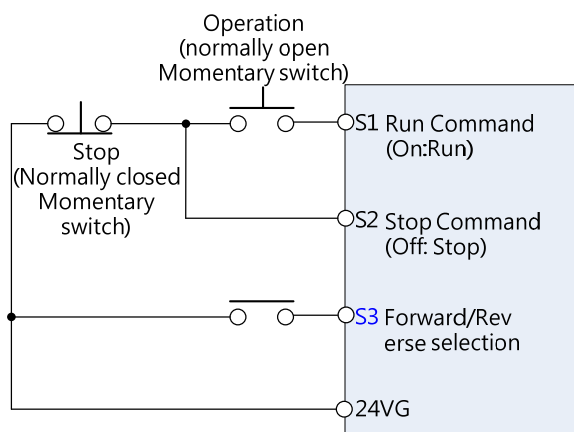

Figure 4.3.2 3 wiring example of 3-wire

- Terminal S1 must be closed for a minimum of 50ms to activate operation, please refer below.

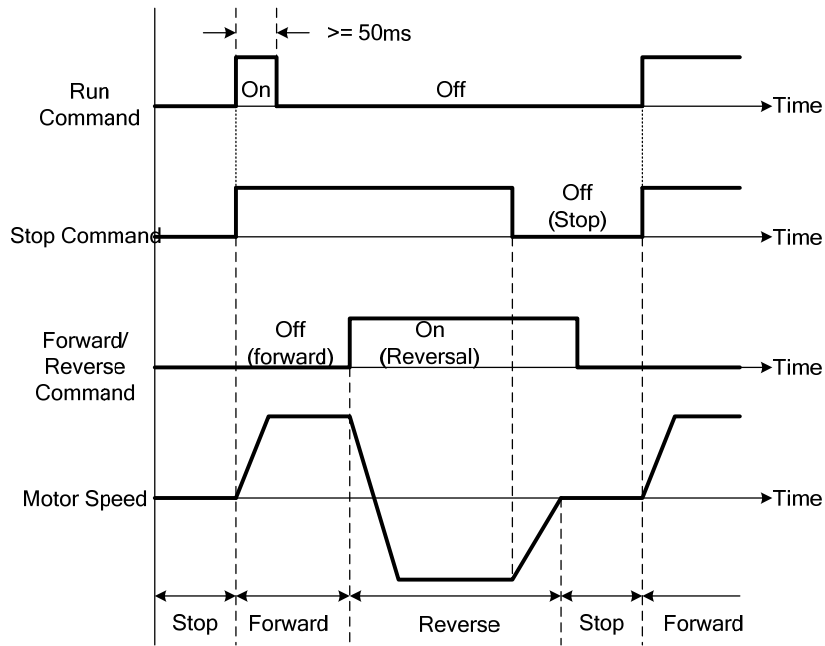

Figure 4.3.3 3-wire operation

00- 05	Main Frequency Command Source Selection
00- 06	Alternative Frequency Command Source Selection
Range	<p>【0】 : Up/Down of Keypad 【1】 : Potentiometer on Keypad 【2】 : External AI1 Analog Signal Input 【3】 : External AI2 Analog Signal Input 【4】 : External Up/Down Frequency Control 【5】 : Communication Setting Frequency 【6】 : Reserved 【7】 : Pulse Input</p>

(1) 00-05/00-06=0

- Use the digital operator to enter frequency reference or to set parameter 05-01 (frequency reference 1), please refer section 4.1.4 for the details.
- If 00-06=0, the value of alternative frequency command only can be set in parameter 05-01.

(2) 00-05/00-06=1

- Use the potentiometer to enter frequency source

(3) 00-05/00-06=2 or 3

- Use analog reference from analog input AI1 or AI2 to set the frequency reference (as shown in Figure 4.4.4). Refer to parameters 04-00 to select the signal type
- If the main frequency input signal is analog voltage signal, please set JP1 (AI1) to V. If the main frequency input signal is analog current signal, please set JP1 (AI1) to I.

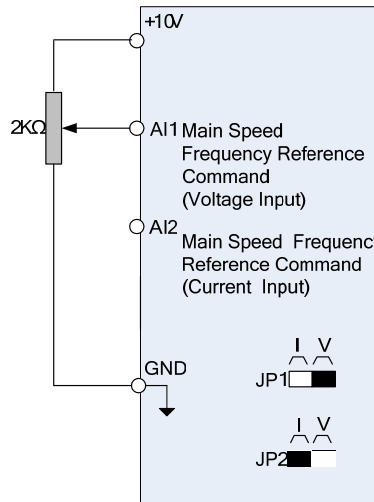

Figure 4.3.4 Analog input as main frequency reference command

Note :

1. When analog current input signal connects to AI2, please set JP3 to I (default setting) and set 04-00=0~3 (AI2=0~20mA / 4 ~ 20mA) °
2. When analog voltage input signal connects to AI2, please set JP3 to V (default setting) and set 04-00=0~3 (AI2=0~10V / 2~10V) °
3. Please set parameter 04-00 correctly according to your AI1/AI2 signal.

(4) 00-05/00-06=4

- The inverter accelerates with the UP command closed and decelerates with the DOWN command closed. Please refer to parameter 03-00~03-05 for additional information.

(5) 00-05/00-06=5

- Please use MODICON series PLC or other devices which uses MODBUS protocol to communicate, please set the correct baud-rate for communication according to the details in chapter 09.

(6) 00-05/00-06=7

- To use this function a pulse train input is required to be connected to the PI input and GND, please refer the photo as Fig.4.3.5. PI input terminal, built-in resistance, is not required to connect the resistance if open collector input mode is used

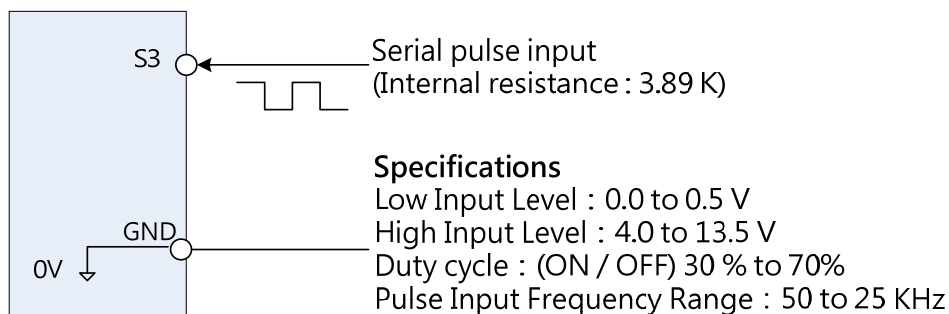

Figure 4.3.5 Frequency reference from pulse input

00- 07	Main and Alternative Frequency Command modes
Range	【0】 : Main frequency 【1】 : Main frequency + alternative frequency

- When 00-07=0, the frequency source is set by the Main frequency parameter 00-05.
- When 00-07=1, The frequency command will be the result of setting of main and alternative frequencies. The inverter will display the SE01 error when 00-07=1 and parameter 00-05 and 00-06 are set to the same selection.
- When parameter 00-06 is set to 0 (Keypad) the alternative frequency reference is set by parameter 05-01 (Frequency setting of speed-stage 0).

00- 08	Communication frequency command
Range	【0.00~599.00】 Hz

- This parameter only can be used to read the set frequency in communication mode.
- This parameter is only effective in the communication mode.

00- 09	Frequency Command save on power down
Range	【0】 : Disable 【1】 : Enable

- This parameter is only enabled in communication mode

00- 10	Initial Frequency Selection of Stop
Range	【0】 : By Current Frequency Command 【1】 : By Zero Frequency Command 【2】 : By Parameter 00-11

- The parameter only can be used when main frequency source comes from keypad.
- When 00-10=0, the initial frequency is set by the current frequency.
- When 00-10=1, the initial frequency will be reset to 0.
- When 00-10=2, the initial frequency will be set by 00-11.

00- 11	Initial Frequency Setpoint
Range	0.00-599.00
00-12	Frequency Upper limit
Range	【0.01-599.00】 Hz
00-13	Frequency Lower limit
Range	【0.00-598.99】 Hz

- Set the maximum frequency reference is 100% of the 01-02 or 01-16.
- The inverter will display the SE01 error when 00-12 value is lower than 00-13. Frequency upper and lower limit is active for all frequency reference modes.
- When 00-13>0 and output frequency<00-13, inverter output frequency will be based on 00-13.

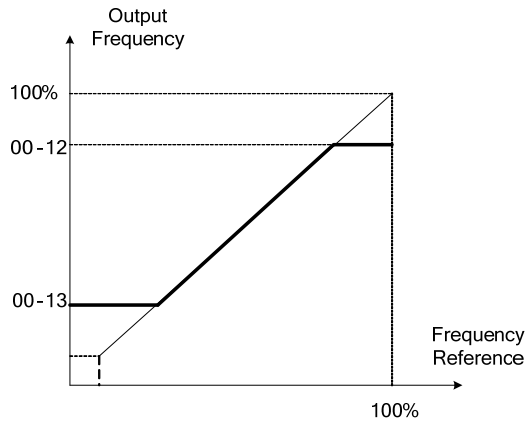

Figure 4.3.6 Frequency reference upper and lower limits

00-14	Acceleration time 1
Range	【0.1~6000.0】 Sec
00-15	Deceleration time 1
Range	【0.1~6000.0】 Sec
00-16	Acceleration time 2
Range	【0.1~6000.0】 Sec
00-17	Deceleration time 2
Range	【0.1~6000.0】 Sec
00-21	Acceleration time 3
Range	【0.1~6000.0】 Sec
00-22	Deceleration time 3
Range	【0.1~6000.0】 Sec
00-23	Acceleration time 4
Range	【0.1~6000.0】 Sec
00-24	Deceleration time 4
Range	【0.1~6000.0】 Sec

Preset Acceleration and Deceleration times set by above parameters.

Factory setting of acceleration time is 00-14, factory setting of deceleration time is 00-15.

- Acceleration time is the time required to accelerate from 0 to 100% of maximum output frequency (01-02 or 01-16).
- Deceleration time is the time required to decelerate from 100 to 0% of maximum output frequency (01-02 or 01-16).

The default values for the accele. / decal. times are dependent on the inverter size.

Size		Acceleration / Deceleration Default Value
200V series	400V series	
1~10HP	1~15HP	10s
15~20HP	20~25HP	15s
25~40HP	30~75HP	20s

A. Select acceleration and deceleration time via the digital input terminals

The following table shows the acceleration / deceleration selected when the digital input function Accel/ Decel time 1 is used.

Table 4.3.1 Acceleration/Deceleration Time Selection

Accel/decel time 1 (Set 03-00 to 03-05=10)	Acceleration Time	Deceleration Time
0	Tacc1(00-14)	Tdec1(00-15)
1	Tacc2(00-16)	Tdec2(00-17)
0 : OFF 1 : ON		

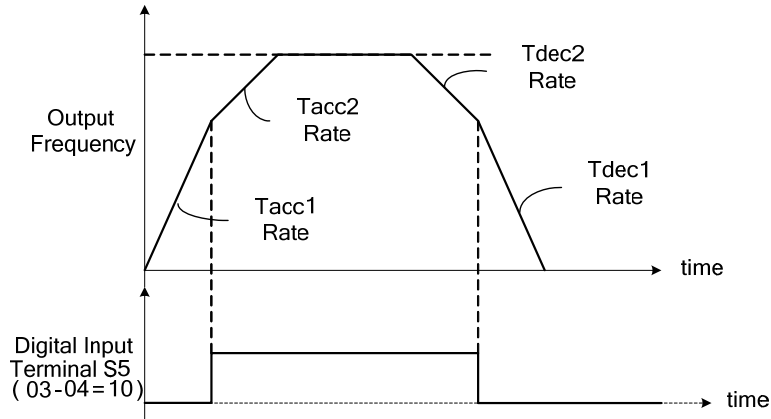

Figure 4.3.7 Digital input S5 switch between Tacc1/Tacc2 and Tdec1/Tdec2

B. Switch of Acceleration/Deceleration time according to motors

03-00~03-06 set to 40 (Switching between motor 1/motor 2), it can switch motors by digital input. (Motor 1 and Motor 2 selection function only for V/F control mode.)

- When motor 1 selected, please refer table 4.3.1 for acceleration/deceleration time selection.
- When motor 2 selected, please refer the table below of acceleration/deceleration time selection.

Motor 2 selected		
Acceleration/Deceleration Selection (Set 03-00 to 03-05 = 10)	Acceleration Time	Deceleration Time
0	Tacc3(00-21)	Tdec3(00-22)
1	Tacc4(00-23)	Tdec4(00-24)

00-18	Jog frequency
Range	【0.00~599.00】 Hz
00-19	Jog acceleration time
Range	【0.1~600.0】 Sec
00-20	Jog deceleration time
Range	【0.1~600.0】 Sec

- Jog acceleration time (00-19) is the time required to accelerate from 0 to 100% of maximum output frequency (01-02 or 01-16). Jog deceleration time (00-20) is the time required to decelerate from 100 to 0% of maximum output frequency (01-02 or 01-16).
- The JOG function is operational by using the multi-function input terminals S1 to S6 (00-02=1) and setting the relevant parameters 03-00~03-05 to 6 or 7, the motor will run by the setting. Refer to parameter group 3.

00-26	Emergency stop time
Range	【0.1~6000.0】 Sec

When emergency stop input is activated the inverter will decelerate to a stop using the Emergency stop time

- When digital input set to 14, inverter will decelerate to stop by emergency stop time (00-26).
- To cancel the emergency stop condition the run command has to be removed and emergency stop input deactivated

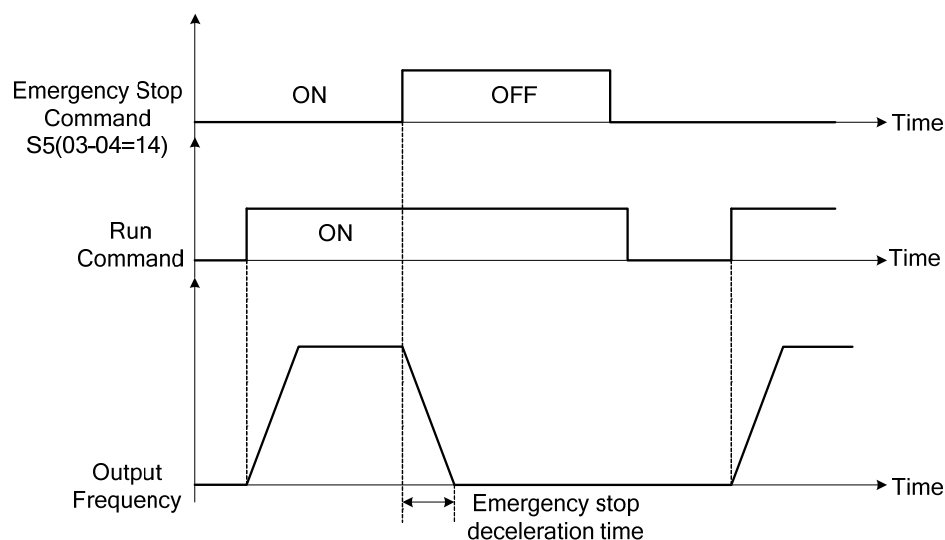

Figure 4.3.9 Emergency stop example

00-27	HD/ND Mode
Range	【0】 : HD (Heavy Duty / Constant Torque) 【1】 : ND (Normal Duty / Variable Torque)

- The inverter overload curve, carrier frequency, stalls prevention level, rated input/output current and maximum frequency are automatically set based on the inverter duty (HD/ND) selection. Please refer to table 4.3.2 for detailed information. °

Table 4.3.2 Heavy Duty (Constant torque) / Normal Duty (Variable torque)

00-27	Overload capacity	Carrier frequency	Maximum output frequency	Stall prevention level	Rated input / output current
0 (H/D mode)	150%, 1min	2-16KHz	599.00Hz	150% (08-00, 08-01)	Refer to section 3.7
1 (N/D mode)	120%, 1min	2-16KHz	120.00Hz	120% (08-00, 08-01)	

Note : ND mode only can be used for 25-40HP of 200V class and 30-75HP of 400V class.

- Select V/F curve (Group 1) and enter motor data (Group 2) to match the application.
- In H/D mode, the maximum output frequency is 599Hz for all control modes, except for SLV where the maximum output frequency is limited based on the inverter rating, see table below.

Horsepower	Special circumstances	Maximum output frequency
220V 1~10HP, 440V 1~15HP	-	150Hz
220V 15~20HP, 440V 20HP	-	110Hz
440V 25HP	-	100Hz
220V 25~40HP, 440V 30~75HP,	11-01 set to 8KHz(included) or below	100Hz
220V 25~40HP, 440V 30~75HP,	11-01 set to 8KHz or higher	80Hz

Note : In normal duty mode only applies to control modes V/F . All other modes must use the Heavy Duty settings.

00- 34	Language
Range	【0】 : English 【1】 : Simplified Chinese 【2】 : Traditional Chinese 【3】 : Turkish

It is required to be with LCD keypad to display the language selection of parameter 00-34

- 00-34=0, LCD keypad displays in English.
- 00-34=1, LCD keypad displays in Simplified Chinese.
- 00-34=2, LCD keypad displays in Traditional Chinese.
- 00-34=3, LCD keypad displays in Turkish.

Note : It will not restore to the default value when this parameter performs initialization.

00- 35	Minumum Frequency Detection
Range	【0】 : Alarm 【1】 : Keep Running at Lower Frequency

- 00-35=0, when output frequency lower than minimum frequency (01-08), display will show STP0 alarm.
- 00-35=1, when the frequency command is lower than minimum frequency, inverter will keeping running at minimum frequency.

00- 36	PID Lower Frequency Selection
Range	【0】 : Lower Frequency of PID Sleep Mode 【1】 : 0Hz of PID Sleep Mode

- When 00-36=0, the lower frequency of PID sleep mode will base on 10-17~10-20.
- When 00-36=1, the lower frequency of PID sleep mode is 0Hz.

Group 01 V/F Control Parameters

01-00	Volts/Hz Patterns
Range	【0~FF】

- Make sure to set the inverter input voltage parameter 01-14
- There are three ways to set V/F curve :
 - (1) 01-00 = 0 to E : Choose any of the 15 predefined curves (0 to E)
 - (2) 01-00 = 0F : Use 01-02~01-09 and 01-12~01-13, with voltage limit
 - (3) 01-00 = FF : Use 01-02~01-09 and 01-12~01-13, without voltage limit.

Refer to the following figure :

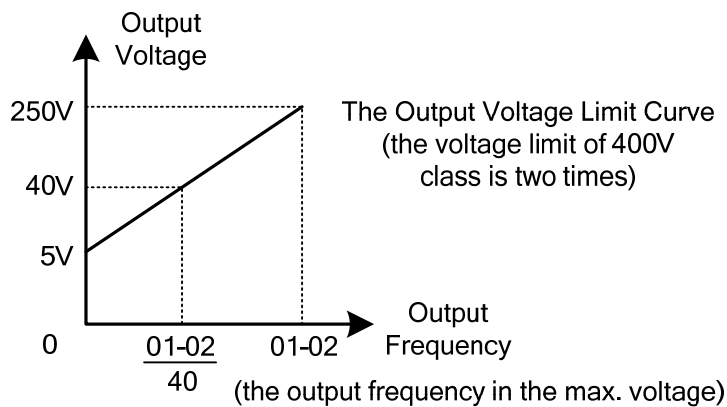

- The default parameters (01-02~01-09) are the same when 01-00 is set to F (default) and 01-00 is set to 1.
- Parameters 01-02 to 01-13 are automatically set when any of the predefined V/F curves are selected. Please refer table 4.3.3~4.3.5 for the features of V/F pattern. °
- When V/F curves are selected, frequency will be limited by 00-12 and 00-13.
- This parameter is not affected by the initialization parameter (13-08)

Table 4.3.3 2P5 - 2HP V/F curve selection (200V)

Type	Specification	01-00	V/F curve	Type	Specification	01-00	V/F curve			
General purpose	50Hz	0		High Starting Torque*	50Hz	8				
		F (50Hz Default setting)	9							
	60 Hz	60Hz Saturation	1			60Hz	Low Starting Torque	A		
		50Hz Saturation	2				High Starting Torque	B		
Variable Torque Characteristic	72Hz	3		Constant-power torque(Reducer)	90Hz	C				
		50 Hz	Variable Torque 1			4		120Hz	D	
			Variable Torque 2			5			180Hz	E
	60 Hz	Variable Torque 3	6			60 Hz	Variable Torque 4	7		
		Variable Torque 4	7							

Table 4.3.4 3 - 30HP V/F curve selection (200V)

Type	Specification	01-00	V/F curve	Type	Specification	01-00	V/F curve	
General application	50Hz	0		High Starting Torque*	Low Starting Torque	8		
		F (50Hz Default setting)	High Starting Torque		9			
	60Hz	60Hz Saturation	1			Low Starting Torque	A	
		50Hz Saturation	2			High Starting Torque	B	
Variable Torque Characteristic	72Hz		3	Constant-power torque (Reducer)	90Hz		C	
	50Hz	Variable Torque 1	4		120Hz	D		
		Variable Torque 2	5					
	60Hz	Variable Torque 3	6		180Hz	E		
		Variable Torque 4	7					

Table 4.3.5 40HP and above V/F curve selection (200V)

Type	Specification	01-00	V/F curve	Type	Specification	01-00	V/F curve	
General application	50Hz	0		High Starting Torque*	50Hz	Low Starting Torque (8)		
		F (50Hz Default setting)	High Starting Torque (9)					
	60Hz	1			60Hz	Low Starting Torque (A)		
		F (60Hz Default setting)	High Starting Torque (1),(F)			High Starting Torque (A)		
		50Hz Saturation	2				High Starting Torque (B)	
	Variable Torque Characteristic	72Hz	3			Constant-power torque (Reducer)	90Hz	C
50Hz		Variable Torque 1	4		120Hz		D	
		Variable Torque 2	5					
60Hz		Variable Torque 3	6		180Hz		E	
		Variable Torque 4	7					

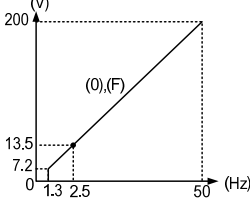
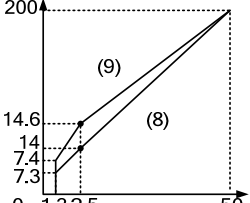
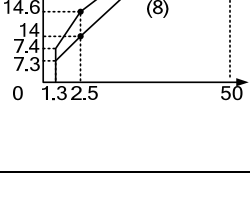
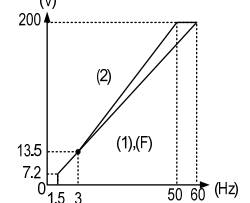
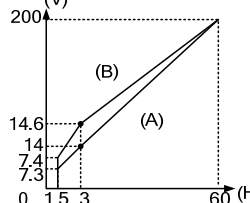
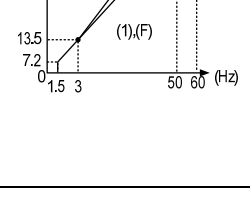
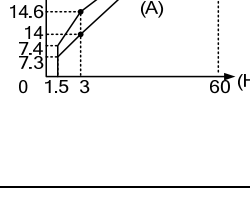
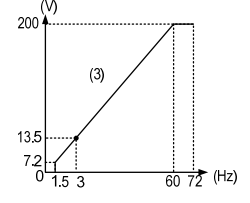
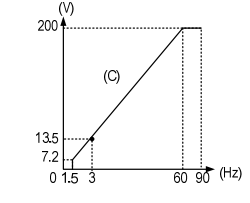
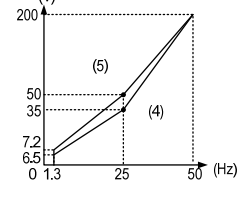
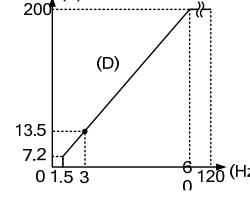
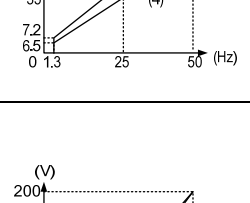
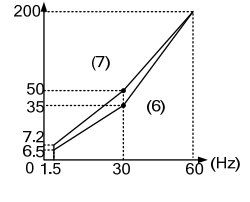
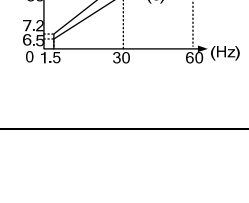
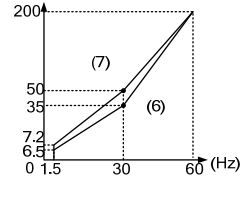
Table 4.3.6 2P5- 2HP V/F curve selection (220V)

Type	Specification	01-00	V/F curve	Type	Specification	01-00	V/F curve						
General application	50Hz	0		High Starting Torque*	50Hz	8							
		F (50Hz Default setting)	9										
	60Hz	60Hz Saturation	1		60Hz	Low Starting Torque	A						
			F (60Hz Default setting)				B						
	50Hz Saturation	2											
Variable Torque Characteristic	72Hz	3		Constant-power torque (Reducer)	90Hz	C							
								50Hz	Variable Torque 1	4	120Hz	D	
									Variable Torque 2	5			
	60Hz	Variable Torque 3	6		60								
		Variable Torque 4	7										

Table 4.3.7 3 - 30HP V/F curve selection (220V)

Type	Specification	01-00	V/F curve	Type	Specification	01-00	V/F curve	
General application	50Hz	0		High Starting Torque ⁺	50Hz	8		
		F (50Hz Default setting)	9					
	60Hz	1			60Hz	Low Starting Torque	A	
		F (60Hz Default setting)	2				Low Starting Torque	B
Variable Torque Characteristic	72Hz	3		Constant-power torque (Reducer)	90Hz	C		
		4				120Hz	D	
	5		180Hz		E			
	6				Variable Torque 1	4		
60Hz	Variable Torque 2	5		Variable Torque 3	6			
	Variable Torque 4	7		Variable Torque 4	7			

Table 4.3.8 40HP and above V/F curve selection (220V)

Type	Specification	01-00	V/F curve	Type	Specification	01-00	V/F curve	
General application	50Hz	0		High Starting Torque*	50Hz	8		
		F (50Hz Default setting)	9					
	60Hz	1			60Hz	Low Starting Torque	A	
		F (60Hz Default setting)	2			50Hz Saturation	B	
Variable Torque Characteristic	72Hz	3		Constant-power torque (Reducer)	90Hz	C		
	50Hz	Variable Torque 1	4		120Hz	D		
		Variable Torque 2	5					
	60Hz	Variable Torque 3	6		180Hz	E		
		Variable Torque 4	7					

Table 4.3.9 2P5 - 2HP V/F curve selection (230V)

Type	Specification	01-00	V/F curve	Type	Specification	01-00	V/F curve	
General application	50Hz	0		High Starting Torque*	Low Starting Torque	8		
		F (50Hz Default setting)	High Starting Torque		9			
	60Hz	60Hz Saturation	1		60Hz	Low Starting Torque	A	
		50Hz Saturation	2			Low Starting Torque	B	
Variable Torque Characteristic	72Hz			Constant-power torque (Reducer)	90Hz			
	50Hz	Variable Torque 1	4			120Hz		
		Variable Torque 2	5			180Hz		
	60Hz	Variable Torque 3	6					
		Variable Torque 4	7					

Table 4.3.10 3 - 30HP V/F curve selection (230V)

Type	Specification	01-00	V/F curve	Type	Specification	01-00	V/F curve		
General application	50Hz	0		High Starting Torque*	50Hz	Low Starting Torque	8		
		High Starting Torque	9						
	60Hz	60Hz Saturation	1		60Hz	Low Starting Torque	A		
		50Hz Saturation	2			Low Starting Torque	B		
Variable Torque Characteristic	72Hz		3	Constant-power torque (Reducer)	90Hz		C		
	50Hz	Variable Torque 1	4			120Hz		D	
		Variable Torque 2	5			180Hz		E	
	60Hz	Variable Torque 3	6						
		Variable Torque 4	7						

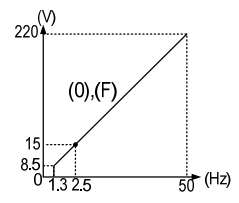
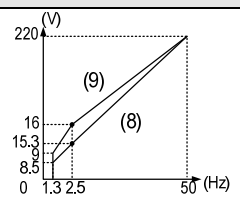
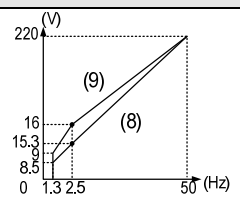
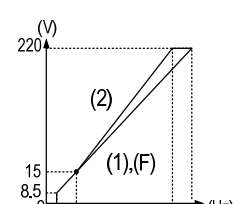
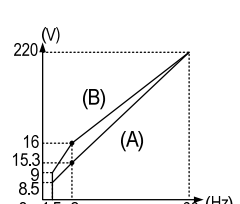
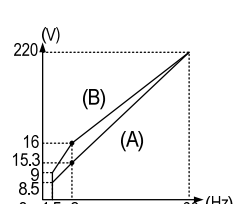
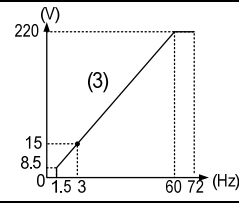
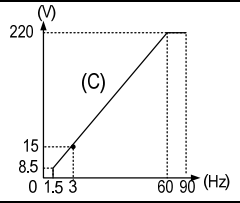
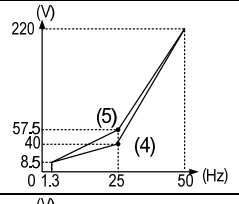
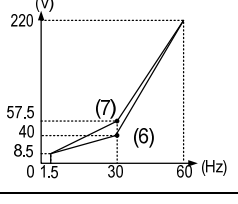
Table 4.3.11 40HP and above V/F curve selection (230V)

Type	Specification	01-00	V/F curve	Type	Specification	01-00	V/F curve	
General application	50Hz	0		High Starting Torque*	50Hz	8		
		F (50Hz Default setting)	9					
	60Hz	60Hz Saturation	1		60Hz	Low Starting Torque	A	
		50Hz Saturation	2			Low Starting Torque	B	
Variable Torque Characteristic	72Hz			Constant-power torque (Reducer)	90Hz			
	50Hz	Variable Torque 1	4			120Hz		
		Variable Torque 2	5			180Hz		
	60Hz	Variable Torque 3	6			90Hz		
		Variable Torque 4	7			120Hz		
	60Hz		180Hz			180Hz		

Tbale 4.3.12 2P5 - 2HP V/F curve selection (380V)

Type	Specification	01-00	V/F curve	Type	Specification	01-00	V/F curve	
General application	50Hz	0		High Starting Torque*	Low Starting Torque	8		
		F (50Hz Default setting)			High Starting Torque	9		
	60Hz	60Hz Saturation	1		60Hz	Low Starting Torque	A	
		50Hz Saturation	2			Low Starting Torque	B	
Variable Torque Characteristic	72Hz		3		Constant-power torque (Reducer)	90Hz	C	
	50Hz	Variable Torque 1	4			120Hz	D	
		Variable Torque 2	5			180Hz	E	
	60Hz	Variable Torque 3	6					
		Variable Torque 4	7					

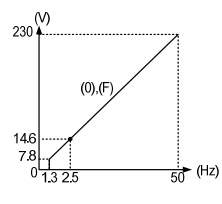
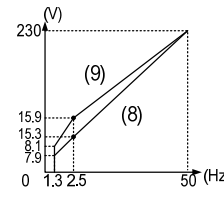
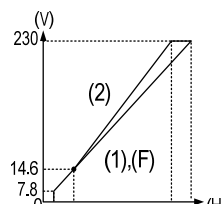
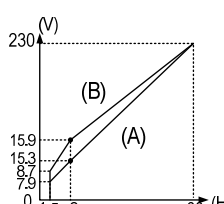
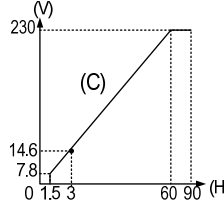
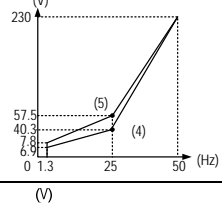
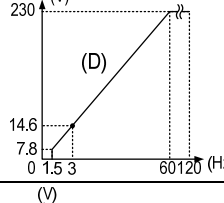
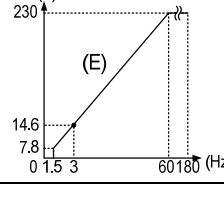
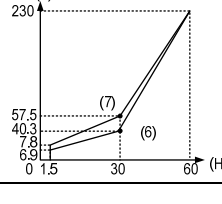
Table 4.3.13 3 - 30HP V/F curve selection (380V)

Type	Specification	01-00	V/F curve	Type	Specification	01-00	V/F curve		
General application	50Hz	0		High Starting Torque*	50Hz	Low Starting Torque	8		
		High Starting Torque	9						
	60Hz	60Hz Saturation	1		60Hz	Low Starting Torque	A		
		50Hz Saturation	2			Low Starting Torque	B		
Variable Torque Characteristic	72Hz		3		Constant-power torque (Reducer)	90Hz		C	
	50Hz	Variable Torque 1	4			120Hz		D	
		Variable Torque 2	5			180Hz		E	
	60Hz	Variable Torque 3	6						
		Variable Torque 4	7						

Table 4.3.14 40HP and above V/F curve selection (380V)

Type	Specification	01-00	V/F curve	Type	Specification	01-00	V/F curve		
General application	50Hz	0		High Starting Torque*	50Hz	8			
		F (50Hz Default setting)	9						
	60Hz	60Hz Saturation	1			60Hz	Low Starting Torque	A	
		50Hz Saturation	2			Low Starting Torque	B		
Variable Torque Characteristic	72Hz		3	Constant-power torque (Reducer)	90Hz		C		
	50Hz	Variable Torque 1	4		120Hz	D			
		Variable Torque 2	5					180Hz	E
	60Hz	Variable Torque 3	6		180Hz	E			
		Variable Torque 4	7						

Table 4.3.15 1 - 2HP V/F curve selection (400V)

Type	Specification	01-00	V/F curve	Type	Specification	01-00	V/F curve		
General application	50Hz	0		High Starting Torque ⁺	50Hz	8			
		F (50Hz Default setting)				9			
	60Hz	60Hz Saturation	1			60Hz	Low Starting Torque	A	
		50Hz Saturation	2			Low Starting Torque	B		
Variable Torque Characteristic	72Hz		3		Constant-power torque (Reducer)	90Hz		C	
	50Hz	Variable Torque 1	4			120Hz		D	
		Variable Torque 2	5			180Hz		E	
	60Hz	Variable Torque 3	6						
		Variable Torque 4	7						

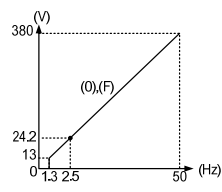
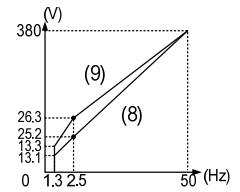
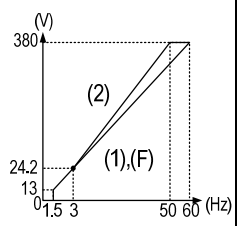
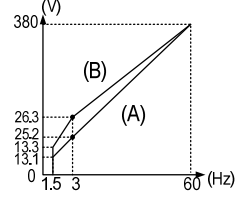
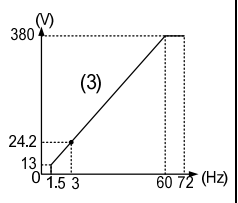
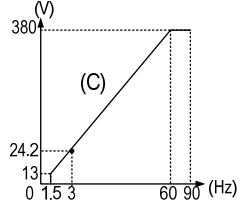
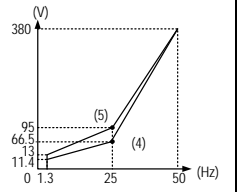
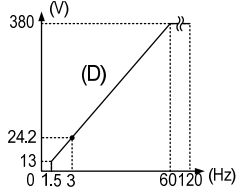
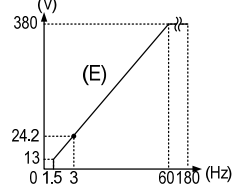
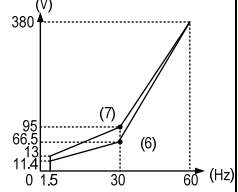
Table 4.3.16 3 - 30HP V/F curve selection (400V)

Type	Specification	01-00	V/F curve	Type	Specification	01-00	V/F curve		
General application	50Hz	0		High Starting Torque*	50Hz	Low Starting Torque	8		
		High Starting Torque	9						
	60Hz	60Hz Saturation	1		60Hz	Low Starting Torque	A		
		50Hz Saturation	2			Low Starting Torque	B		
Variable Torque Characteristic	72Hz		3		Constant-power torque (Reducer)	90Hz		C	
	50Hz	Variable Torque 1	4			120Hz		D	
		Variable Torque 2	5			180Hz		E	
	60Hz	Variable Torque 3	6			90Hz		C	
		Variable Torque 4	7			120Hz		D	
	60Hz		60Hz	6			180Hz		E

Table 4.3.17 40HP and above V/F curve selection (400V)

Type	Specification	01-00	V/F curve	Type	Specification	01-00	V/F curve	
General application	50Hz	0		High Starting Torque*	50Hz	8		
		F (50Hz Default setting)				9		
	60Hz	1			60Hz	A		
		F (60Hz Default setting)				2		B
Variable Torque Characteristic	72Hz	3		Constant-power torque (Reducer)	90Hz	C		
		50Hz	4				120Hz	D
	Variable Torque 2		5					
	60Hz	6			60Hz	E		
		Variable Torque 3						7

Table 4.3.18 1 - 2HP V/F curve selection (415V)

Type	Specification	01-00	V/F curve	Type	Specification	01-00	V/F curve		
General application	50Hz	0		High Starting Torque*	50Hz	8			
		F (50Hz Default setting)	9						
	60Hz	60Hz Saturation	1			60Hz	Low Starting Torque	A	
		F (60Hz Default setting)	2				50Hz Saturation	B	
Variable Torque Characteristic	72Hz	3		Constant-power torque (Reducer)	90Hz	C			
		50Hz	Variable Torque 1			4		120Hz	D
	Variable Torque 2		5		180Hz	E			
	60Hz	Variable Torque 3	6				180Hz	E	
		Variable Torque 4	7						

Table 4.3.19 3 - 30HP V/F curve selection (415V)

Type	Specification	01-00	V/F curve	Type	Specification	01-00	V/F curve		
General application	50Hz	0		High Starting Torque*	50Hz	8			
		F (50Hz Default setting)				9			
	60Hz	60Hz Saturation	1			60Hz	Low Starting Torque	A	
		50Hz Saturation	2			Low Starting Torque	B		
Variable Torque Characteristic	72Hz			Constant-power torque (Reducer)	90Hz				
	50Hz	Variable Torque 1	4			120Hz			
		Variable Torque 2	5			180Hz			
	60Hz	Variable Torque 3	6			90Hz			
		Variable Torque 4	7			120Hz			
	60Hz		6			180Hz			
60Hz		7	180Hz						

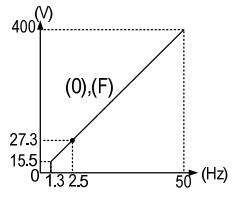
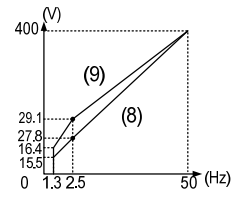
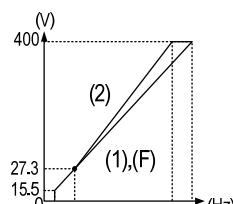
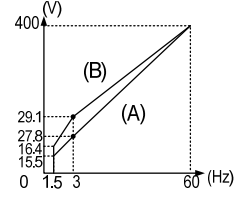
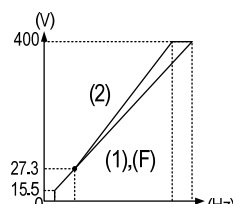
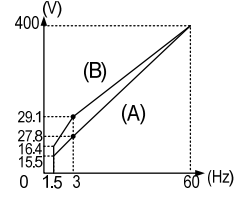
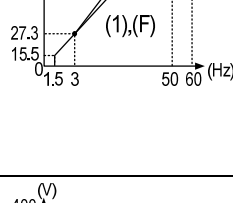
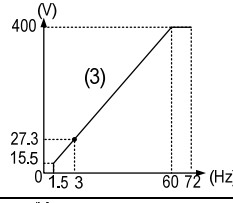
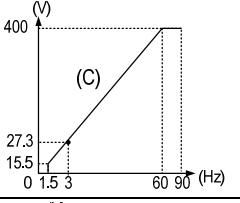
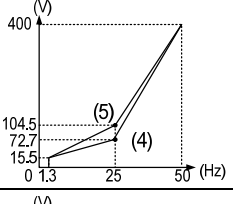
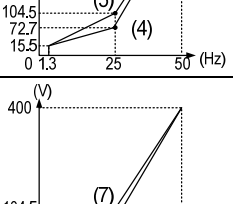
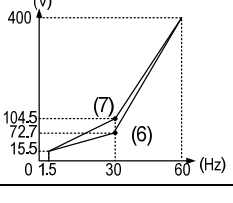
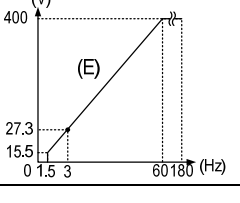
Table 4.3.20 40HP and above V/F curve selection (415V)

Type	Specification	01-00	V/F curve	Type	Specification	01-00	V/F curve		
General application	50Hz	0		High Starting Torque*	50Hz	Low Starting Torque	8		
		High Starting Torque	9						
	60Hz	60Hz Saturation	1			60Hz	Low Starting Torque	A	
		50Hz Saturation	2				Low Starting Torque	B	
	Variable Torque Characteristic	72Hz				Constant-power torque (Reducer)	90Hz		
		50Hz	Variable Torque 1		4			120Hz	
Variable Torque 2			5	180Hz					
60Hz		Variable Torque 3	6						
		Variable Torque 4	7						

Table 4.3.21 1 - 2HP V/F curve selection (440V)

Type	Specification	01-00	V/F curve	Type	Specification	01-00	V/F curve	
General application	50Hz	0		High Starting Torque*	50Hz	8		
		F (50Hz Default setting)				9		
	60Hz	1			60Hz	Low Starting Torque	A	
		60Hz Saturation	F (60Hz Default setting)				High Starting Torque	9
	50Hz Saturation	2			Low Starting Torque	B		
Variable Torque Characteristic	72Hz			Constant-power torque (Reducer)	90Hz			
	50Hz	Variable Torque 1	4			120Hz		
		Variable Torque 2	5					
	60Hz	Variable Torque 3	6			180Hz		
		Variable Torque 4	7					

Table 4.3.22 3 - 30HP V/F curve selection (440V)

Type	Specification	01-00	V/F curve	Type	Specification	01-00	V/F curve		
General application	50Hz	0		High Starting Torque*	50Hz	8			
		F (50Hz Default setting)	9						
	60Hz	60Hz Saturation	1			60Hz	Low Starting Torque	A	
		50Hz Saturation	2			Low Starting Torque	B		
Variable Torque Characteristic	72Hz	3		Constant-power torque (Reducer)	90Hz	C			
		50Hz	Variable Torque 1			4		120Hz	D
	Variable Torque 2		5						
	60Hz	Variable Torque 3	6			180Hz	E		
		Variable Torque 4	7						

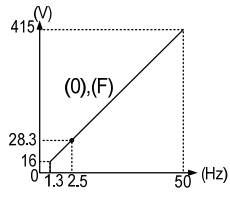
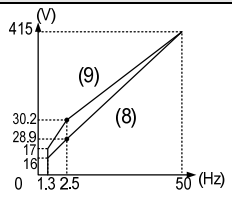
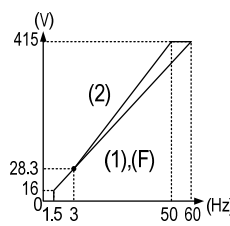
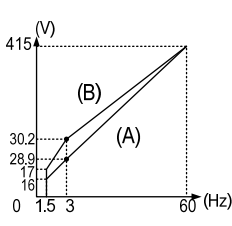
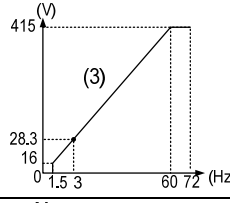
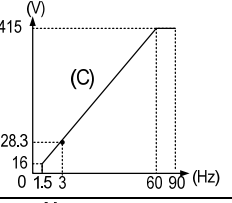
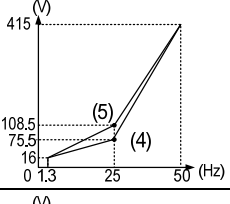
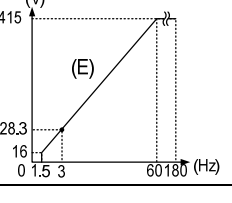
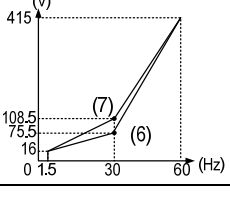
Table 4.3.23 40HP and above V/F curve selection (440V)

Type	Specification	01-00	V/F curve	Type	Specification	01-00	V/F curve		
General application	50Hz	0		High Starting Torque*	50Hz	8			
		F (50Hz Default setting)				9			
	60Hz	60Hz Saturation	1			60Hz	Low Starting Torque	A	
			F (60Hz Default setting)					B	
60Hz	50Hz Saturation	2		Constant-power torque (Reducer)	90Hz	C			
								Variable Torque 1	4
Variable Torque Characteristic	50Hz	Variable Torque 2	5		180Hz	E			
		Variable Torque 3	6						
Variable Torque Characteristic	60Hz	Variable Torque 4	7						

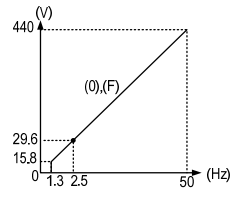
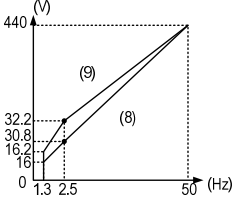
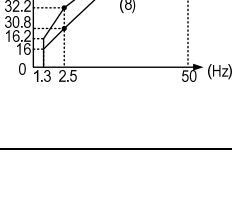
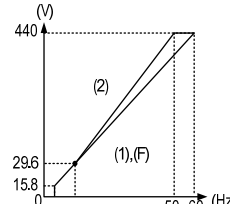
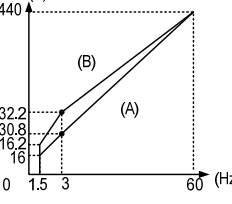
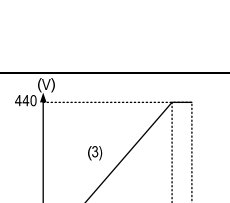
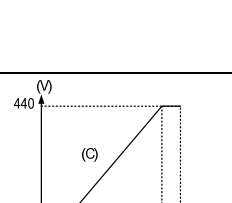
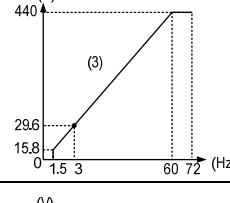
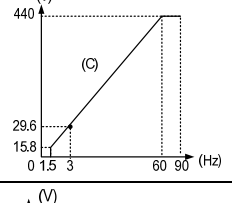
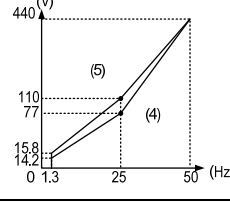
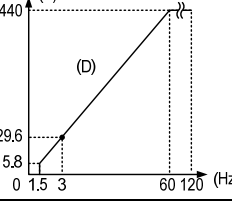
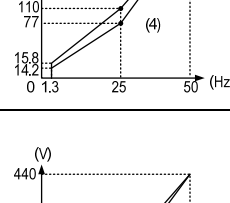
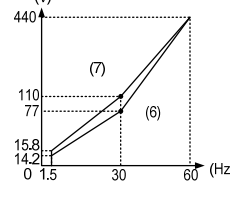
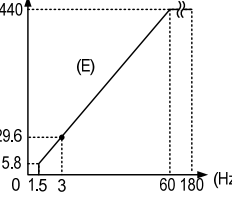
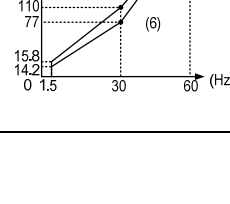
Table 4.3.24 1 - 2HP V/F curve selection (460V)

Type	Specification	01-00	V/F curve	Type	Specification	01-00	V/F curve		
General application	50Hz	0		High Starting Torque*	50Hz	8			
		F (50Hz Default setting)				9			
	60Hz	60Hz Saturation	1			60Hz	Low Starting Torque	A	
		50Hz Saturation	2				Low Starting Torque	B	
Variable Torque Characteristic	72Hz	3		Constant-power torque (Reducer)	90Hz	C			
	50Hz	Variable Torque 1	4			120Hz	D		
		Variable Torque 2	5				180Hz	E	
	60Hz	Variable Torque 3	6			180Hz		E	
		Variable Torque 4	7						

Table 4.3.25 3 - 30HP V/F curve selection (460V)

Type	Specification	01-00	V/F curve	Type	Specification	01-00	V/F curve	
General application	50Hz	0		High Starting Torque*	50Hz	8		
		F (50Hz Default setting)	9					
	60Hz	1			60Hz	Low Starting Torque	A	
		F (60Hz Default setting)	2				Low Starting Torque	B
Variable Torque Characteristic	72Hz	3		Constant-power torque (Reducer)	90Hz	C		
		4				120Hz	D	
	5		60Hz		180Hz		E	
	6							
	Variable Torque 1	4						
	Variable Torque 2	5						
Variable Torque 3	6							
Variable Torque 4	7							

Table 4.3.26 40HP and above V/F curve selection (460V)

Type	Specification	01-00	V/F curve	Type	Specification	01-00	V/F curve			
General application	50Hz	0		High Starting Torque*	50Hz	8				
		F (50Hz Default setting)	9							
	60Hz	60Hz Saturation	1			60Hz		Low Starting Torque	A	
			F (60Hz Default setting)					Low Starting Torque	B	
50Hz Saturation	2	Constant-power torque (Reducer)	90Hz	C						
Variable Torque 1	4						120Hz	D		
	Variable Torque 2				5			180Hz		E
60Hz	Variable Torque 3				6					Constant-power torque (Reducer)
	Variable Torque 4	7								

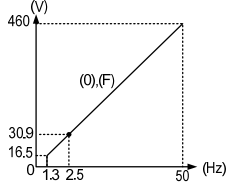
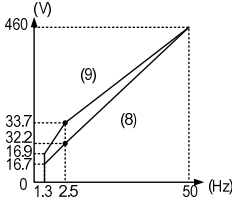
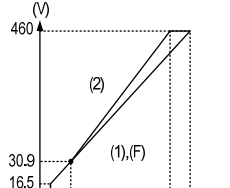
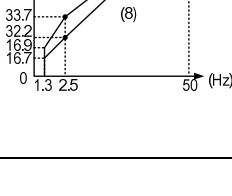
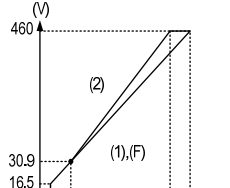
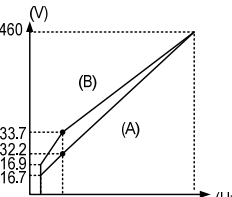
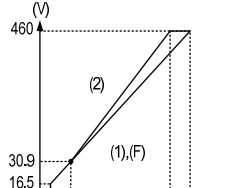
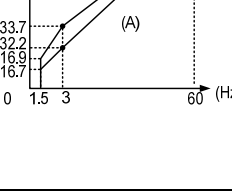
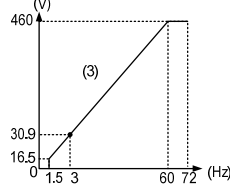
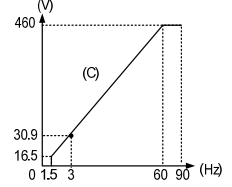
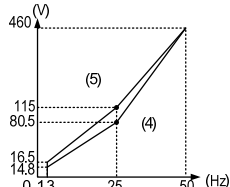
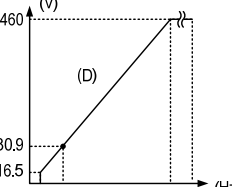
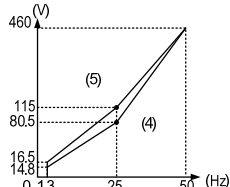
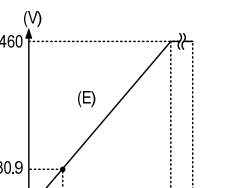
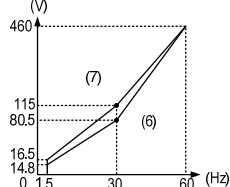
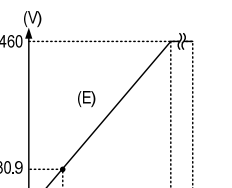
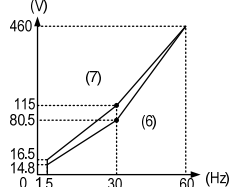
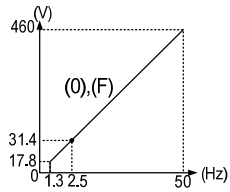
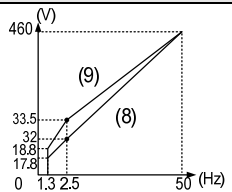
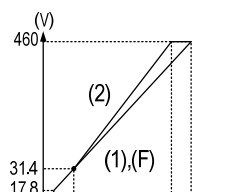
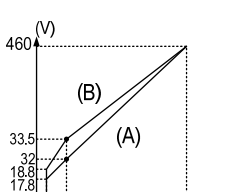
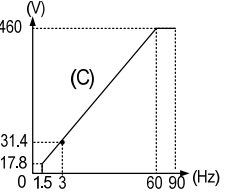
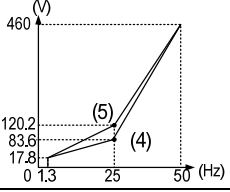
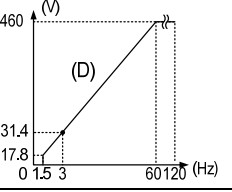
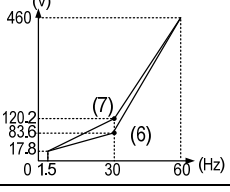
01- 02	Base frequency of motor 1
Range	【4.8~599.0】 Hz
01- 03	Maximum output voltage of motor 1
Range	200V : 【0.1~255.0】 V 400V : 【0.2~510.0】 V
01- 04	Middle output frequency 2 of motor 1
Range	【0.0~599.0】 Hz
01- 05	Middle output voltage 2 of motor 1
Range	200V : 【0.0~255.0】 V 400V : 【0.0~510.0】 V
01- 06	Middle output frequency 1 of motor 1
Range	【0.0~599.0】 Hz
01- 07	Middle output voltage 1 of motor 1
Range	200V : 【0.0~255.0】 V 400V : 【0.0~510.0】 V
01- 08	Minimum output frequency of motor 1
Range	【0.0~599.0】 Hz
01- 09	Minimum output voltage of the motor 1
Range	200V : 【0.0~255.0】 V 400V : 【0.0~510.0】 V
01- 12	Base frequency of motor 1
Range	【4.8~599.0】 Hz
01- 13	Base output voltage of motor 1
Range	200V : 【0.0~255.0】 V 400V : 【0.0~510.0】 V

V/F curve setting (01-02~01-09 and 01-12~01-13)

- Select any of the predefined V/F curves setting 0 to E that best matches your application and the load characteristic of your motor, choose a custom curve setting F or FF to set a custom curve.
- When setting the frequency related parameters for a custom V/F curve values make sure as follows, the SE03 V/F curve tuning error is displayed when the frequency values are set incorrectly.

$$\begin{array}{ccccccccc}
 F_{\max} & > & F_{\text{base}} & > & F_{\text{mid2}} & > & F_{\text{mid1}} & > & F_{\min} \\
 (01-02) & & (01-12) & & (01-04) & & (01-06) & & (01-08)
 \end{array}$$

- When 01-04 and 01-05 (or 01-18 and 01-19) are set to 0, the inverter ignores the set values of $F_{\min 2}$ and $V_{\min 2}$
- The voltage values for 01-02~01-09 are irrelevant.
- The value for maximum output voltage of motor 1(01-03) and the value for base output voltage of motor 1(01-13) will depend on restore factory setting(13-08) to set the value of voltage.
- When the control mode is changed parameter 00-00, 01-08 (F_{\min}) and 01-09 (V_{\min}) will automatically be changed to the default setting of the selected control mode.
- Custom V/F Curve Setting.

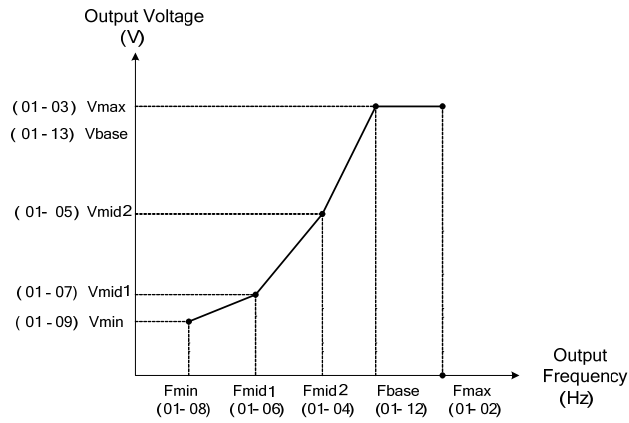

Figure 4.3.12 Custom V/F Curve

- For low torque or high speed applications, the motor may overheat. Make sure to provide adequate cooling when operating the motor under these conditions for a longer period of time
- If the automatic torque boost function is enabled (parameter 01-10), the applied motor voltage will automatically change to provide adequate motor torque during start or operating at low frequency.

SLV Mode (Sensorless Vector Control)

In the SV and SLV mode the V/F curve normally does not have to be re-adjusted after a successful auto-tune.

- The maximum output frequency setting 01-02 (F_{max}), base frequency 01-12 (F_{base}), minimum output frequency 01-08 (F_{min}), maximum output voltage 01-03 (V_{max}) or base output voltage 01-13 (V_{base}) can be adjusted but the voltage is automatically adjusted by the internal current controller.
- Perform the auto-tuning procedure after adjusting parameters 02-19 or 17-04 to reduce the voltage at no-load operation.
- Motor jitter can be reduced by lowering the no-load voltage. Please note that lowering the no-load voltage increases the current at no-load.
- Set the base frequency (01-12, F_{base}) to the motor rated frequency on the motor nameplate.

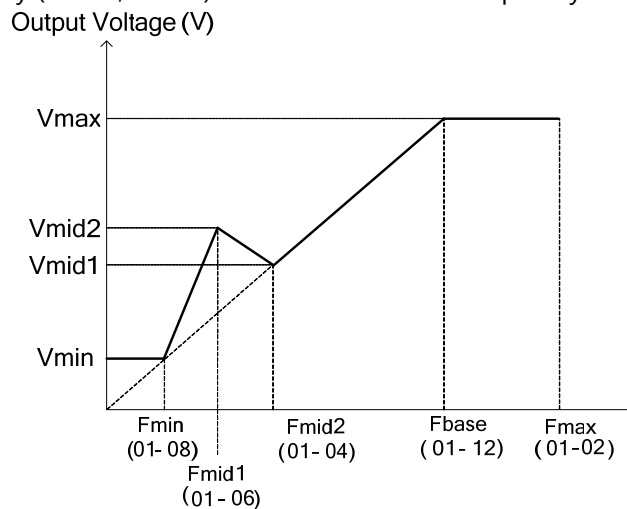

Figure 4.3.13 Torque Boosting

01-10	Torque compensation gain
Range	【0.0~2.0】
01-11	Selection of Torque Compensation Mode
Range	0 : Mode 0 1 : Mode 1

Torque compensation gain (01-10)

- In V/F mode the inverter automatically adjusts the output voltage to adjust the output torque during start or during load changes based on the calculated loss of motor voltage.
- Torque compensation gain (01-10) can adjust in the running time. No need to adjust in general except the following :
 - If the wire between inverter and motor is too long, add the value of 01-10
 - If the capacity of motor is smaller than inverter, add the value of 01-10.
 - If the motor vibrates, reduce the value of 01-10
- Refer to the torque compensation gain adjustment shown in Figure 4.3.14.

Selection of Torque compensation mode (01-11)

- Torque compensation mode 0 is the general mode.
- Torque Compensation Mode 1 is the high speed mode (120~160Hz) and the compensation amount decreases as the increasing frequency. When the speed is at 0~120Hz, the compensation amount is the same as that in torque compensation mode 0.

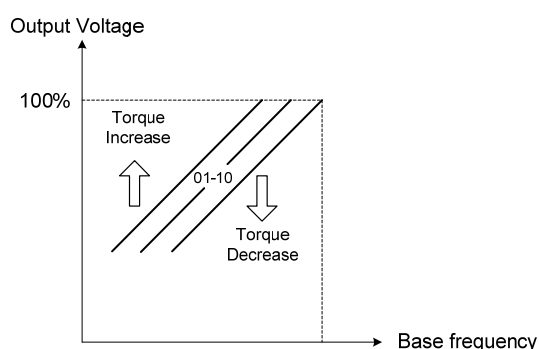

Figure 4.3.14 Torque compensation gain to increase/decrease output torque

01-14	Input voltage setting
Range	200V : 【155.0~255.0】 V 400V : 【310.0~510.0】 V

- The minimum input voltage of inverter is 0.1V.
- Set the input voltage (200V/208V/230V/240V or 380V/415V/440V/460V/480V).
- This parameter is used as a reference for predefined V/F curve calculation (01-00=0 to E), over-voltage protection level, stall prevention, etc...
- If the setting value of 01-14 is lower than actual input voltage, the value of output voltage (12-19) and output power (12-21) on display will incorrect.

Note :

It will depend on restore factory setting (13-08) to set the value of voltage.

01-15	Torque compensation time
Range	【0~10000】 ms

- Set the torque compensation delay time in milliseconds.
- Only adjust in the following situations :
 - ①. Increase the value when experiencing motor vibration.
 - ②. Decrease the value when motor torque response is too slow.

01- 16	Maximum output frequency of motor 2
Range	【4.8~599.0】 Hz
01- 17	Maximum output voltage of motor 2
Range	200V: 【0.1~255.0】 V 400V: 【0.2~510.0】 V
01- 18	Middle output frequency 2 of motor 2
Range	【0.0~599.0】 Hz
01- 19	Middle output voltage 2 of motor 2
Range	200V: 【0.0~255.0】 V 400V: 【0.0~510.0】 V
01- 20	Middle output frequency 1 of motor 2
Range	【0.0~599.0】 Hz
01- 21	Middle output voltage 1 of motor 2
Range	200V: 【0.0~255.0】 V 400V: 【0.0~510.0】 V
01- 22	Minimum output frequency of motor 2
Range	【0.0~599.0】 Hz
01-23	Minimum output voltage of motor 2
Range	200V: 【0.0~255.0】 V 400V: 【0.0~510.0】 V
01- 24	Base frequency of motor 2
Range	【4.8~599.0】 Hz
01- 25	Base voltage of motor 2
Range	200V: 【0.0~255.0】 V 400V: 【0.0~510.0】 V
01- 26	V/F Curve Selection of Motor 2
Range	【0~FF】

Note 1 : Motor 2 V/F curve uses the same settings as motor 1.

Note 2 : Motor 2 V/F curve is the same as Motor 1, please refer to Table 4.4.3~26P

Note 3 : Parameter 01-16~01-25 will be changed when the value of 01-26 is changed.

Group 02 IM Motor Parameters

02- 00	No-load current of motor 1
Range	【0.01~600.00】 A
02- 01	Rated current of motor 1
Range	Lower limit: 10% rated current of V/F mode, 25% rated current of SLV mode Upper limit: According to inverter's rated current
02-03	Rated rotation speed of motor1
Range	【0~60000】 rpm
02- 04	Rated voltage of motor1
Range	200V : 【50.0~240.0】 V 400V : 【100.0~480.0】 V
02- 05	Rated voltage of motor1
Range	【0.01~600.00】 KW
02-06	Rated frequency of motor 1
Range	【4.8~599.0】 Hz
02-07	Pole of motor 1
Range	【2~16】
02-09	Excitation current of motor 1 <1>
Range	【15~70】 % motor rated current
02-10	Core saturation coefficient 1 of motor 1 <1>
Range	【1~100】 %
02-11	Core saturation coefficient 2 of motor 1 <1>
Range	【1~100】 %
02-12	Core saturation coefficient 3 of motor 1 <1>
Range	【80~300】 %
02-13	Core loss of motor 1
Range	【0.0~15.0】 %
02-19	No-Load Voltage of motor 1
Range	200V : 【50~240】 V 400V : 【100~480】 V

Motor parameters are automatically set when performing an auto-tune (17-10=1). In most case no adjustment is required after performing an auto-tune except when using the inverter in special applications (e.g. machine tool, positioning, etc...).

Please refer to parameter group 22 for permanent magnet motor parameters.

➤ **Motor no-load current (02-00).**

Value is calculated based on the motor rated frequency (17-05) and motor rated current (17-03).

➤ **Motor rated current (02-01)**

Set the motor rated current according to the motor nameplate.

- (1) The value of 02-01 needs to be greater than the value set in parameter 02-00, otherwise warning message "SE01" out of range error will be displayed.
- (2) In V/F control mode, slip compensation function will be active when output current is greater than motor no load current.
- (3) In V / F control mode, the output current is greater than the no-load current with slip compensation is enabled.

➤ **Rated rotation speed of motor 1 (02-03)**

Set the motor rpm according to the motor nameplate.

➤ **Motor rated voltage (02-04)**

Set the motor rated voltage according to the motor nameplate.

Set the motor rated voltage and it will adjust maximum output voltage of V/F curve.

➤ **Motor rated power (02-05)**

Set the motor power according to the motor nameplate.

➤ **Rated frequency of motor 1 (02-06)**

Set the motor rated frequency according to the motor nameplate.

➤ **Number of motor poles (02-07)**

Set the number of motor pole according to the motor nameplate.

➤ **Motor excitation current (02-09)**

- (1) The current is obtained from rotational auto-tuning. It is required to perform manual tuning if the inverter cannot rotational auto-tune.
- (2) When the manual tuning is performed, tune it from 33% and observe no-load voltage (the output value) of parameter 12-67. If parameter 12-67 is higher than no-load voltage (the setting value) of parameter 17-08, perform downward revision in parameter 02-09; if it is lower than that, perform upward revision in parameter 02-09.
- (3) Tuning motor excitation current of parameter 02-09 will change motor leakage inductance of parameter 02-17 and motor mutual inductance of parameter 02-18.
- (4) It is required to refer to the actual no-load voltage of parameter 12-76 to tune the motor excitation current of parameter 02-09. Change of the excitation current will also affect the relative actual no-load voltage fluctuation so it is required to tune to the similar setting value of no-load voltage (17-08).

➤ **Setting of motor core's saturation coefficient 1, 2 and 3 (02-10, 02-11, 02-12)**

These parameters are automatically set during auto-tune. No adjustment required. Parameters are set to 50% for 02-10, 75% for 02-11 and 137.5% for 02-12 to reduce the impact of core saturation.

The motor core's saturation coefficient is defined as a percentage of the motor excitation current. When the motor flux reaches 137.5% level, the core's saturation coefficient shall be greater than 137.5%. When the motor flux is 50% or 75%, the core's saturation coefficient is required to be less than 50% and 75%.

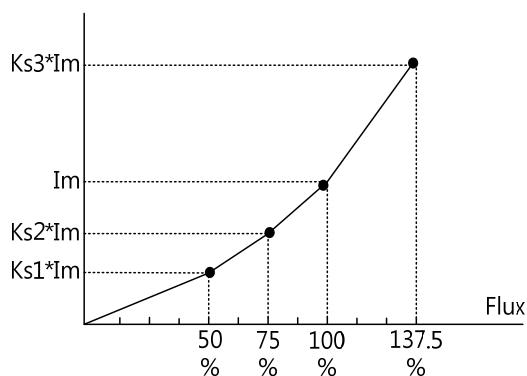

Im : 02-09 Excitation Current

Ks1: 02-10 Motor Core Saturation Coefficients 1

Ks2: 02-11 Motor Core Saturation Coefficients 2

Ks3: 02-12 Motor Core Saturation Coefficients 3

➤ **Motor core loss (02-13)**

Set motor core loss as the percentage of the motor rated power

$$\%W_{\text{core}}(02-13) = \frac{3 \times \text{Motor core loss (Watt)} \times 100\%}{\text{Motor rated power (Watt, 02-05)}}$$

Note : In V/F mode motor core loss (o2-13) is used to for torque compensation.

02-15	Resistance between wires of motor 1
Range	1~60.000
02-16	Rotor resistance gain
Range	1~60.000
02-17	Resistance between wires of motor <1>
Range	1~60.000
02-19	No-Load Voltage of motor 1
Range	【0.01~600.00】 A
02-20	No-Load Current of motor 2
Range	【0.01~600.00】 A
02-21	Rated current of motor 2
Range	10%~200% of inverter rated current
02-22	Rated rotation speed of motor 2
Range	【0~60000】 rpm
02-23	Rated voltage of motor 2
Range	200V: 【50.0~240.0】 V 400V: 【100.0~480.0】 V
02-24	Rated power of motor 2
Range	【0.01~600.00】 KW
02-25	Rated frequency of motor 2
Range	【4.8~599.0】 Hz
02-26	Pole of motor 2
Range	【2~16】
02-32	Resistance between wires of motor 2
Range	【0.001~60.000】 Ω
02-33	Proportion of Motor Leakage Inductance <1>
Range	【0.1~15.0】 %

➤ **Motor line to line resistance (02-15)**

Refer to figure 4.3.15, Y-equivalent model an induction motor

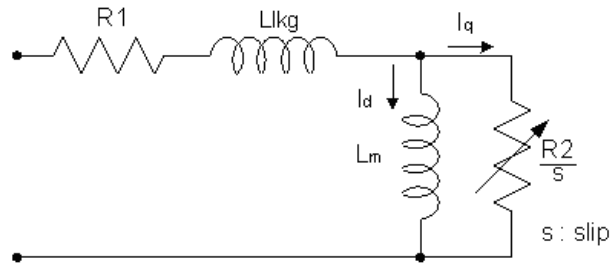

Figure 4.3.15 Y-equivalent model an induction motor

➤ **No-load motor voltage (02-19)**

Parameter determines the rated flux during motor rated rotation in SLV control mode. Set the value of this parameter to the same value as parameter 17-08. A value of 10~50V below the input voltage level ensures that the motor is capable of providing adequate torque performance when operating at nominal speed (or higher speed). Setting the value to small can result in a reduction in no-load current, weakened motor flux and an increase in motor current while the motor is loaded.

➤ **Proportion of Motor Leakage Inductance <1> (02-33)**

(1) It is set by manual tuning function. Normally, it does not need to be adjusted because magnetic function does not exist in this adjustment.

$$\xi = \frac{Lk_g}{L_r}$$

(2) Definition of leakage inductance proportion is the ratio of leakage inductance to rotor inductance. If the default value is set to 3.4%, adjust this ratio will affect the motor leakage inductance parameter to be changed.

(3) When the adjustment of leakage inductance proportion is larger or smaller, it will cause the motor jittering with abnormal noise and the motor cannot run. Generally, the adjusted value is 3.0%~5.0%. 4.0% is the universal adjustment value that can make the motor run normally. The adjustment of leakage inductance proportion depends on the motor rating.

02-34	Motor Slip <1>
Range	【0.1~20.0】 Hz

(1) Normally, it is not required to be adjusted. It can be obtained via manual tuning parameter function. Such tuning does not have magnetic function.

(2) The default value of motor slip is set to 1 Hz. Motor slip is obtained from the nameplate.

Take 60Hz, 4-pole motor for example, synchronous speed :

$$N = \frac{120 \times \text{Frequency}}{\text{Pole}} = \frac{120 \times 60}{4} = 1800\text{rpm}$$

Rated speed in the nameplate is 1700 rpm, then

$$\text{Slip} = \frac{1800-1700}{60} = 1.67 \text{ Hz}$$

- (3) Adjusting motor slip will change the rotor resistance parameter. The motor slip is adjusted depending on the motor performance.
- (4) When inverter is performing auto-tune successful, the parameters of group 2 will be updated by group 17, please refer to group 17 for the details.

Group 03 External Digital Input and Output Parameters

03- 00	Multi-function input terminal S1
03- 01	Multi-function input terminal S2
03- 02	Multi-function input terminal S3
03- 03	Multi-function input terminal S4
03- 04	Multi-function input terminal S5
03- 05	Multi-function input terminal S6
Range	<ul style="list-style-type: none"> 【0】 : Forward/Stop command 【1】 : Reverse/Stop command 【2】 : Multi-speed/position setting command 0 【3】 : Multi-speed/position setting command 1 【4】 : Multi-speed/position setting command 2 【5】 : Multi-speed/position setting command 3 【6】 : Forward jog run command 【7】 : Reverse jog run command 【8】 : UP frequency increasing command 【9】 : DOWN frequency decreasing command 【10】 : Acceleration/deceleration time selection 2 【11】 : Inhibit Acceleration/deceleration command 【12】 : Main/ Alternative Run Switch Function 【13】 : Main/ Alternative Frequency Switch Function 【14】 : Emergency Stop (decelerate to zero and stop) 【15】 : External Baseblock Command(rotation freely to stop) 【16】 : PID control disable 【17】 : Fault reset (Reset) 【18】 : Auto Run Mode Enable 【19】 : Speed Search (ffrom the maximum frequency) 【20】 : Energy Saving (V/F mode only) 【21】 : Reset PID Integral Value to Zero 【22】 : Counter Input 【23】 : Counter Reset 【24】 : PLC Input 【25】 : Pulse-In Width Measure(S3) 【26】 : Pulse-In Frequency Measure (S3) 【27】 : Local/Remote Selection 【28】 : Remote Mode Selection 【29】 : Jog Frequency Selection 【33】 : DC Braking 【34】 : Speed Search 2 (From The Frequency Command) 【40】 : Switching Between Motor 1/Motor 2 【41】 : PID Sleep 【47】 : Fire Mode (S6 terminal only) 【48】 : KEB Acceleration 【57】 : Forced Frequency Run 【63】 : Switch to Constant Pressure 2 【65】 : Short-Circuit Breaking 【66】 : PID Control Disable 2 【68】 : External Fault 【69】 : External Overload

Refer to the multi-function digital input and parameters in the following figure 4.3.16

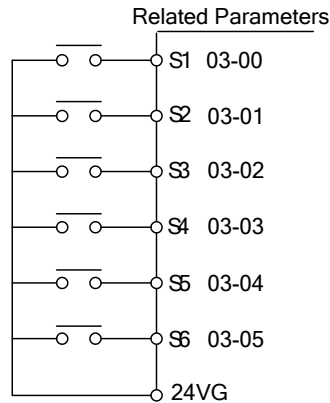

Figure 4.3.16 Multi-function digital input and related parameters

Table 4.3.27 Multi-function digital input setting (03-00 to 03-05) (“O” : Enable, “X” : Disable)

Value	Function		Description	Control Mode		
	Name	LCD Display		V/F	SLV	PM SLV
0	Forward/Stop command	2-Wire (FWD-RUN)	2- wire Forward/Stop command (ON : Forward operation command).	O	O	O
1	Reverse/Stop command	2-Wire (REV-RUN)	2- wire Reverse/Stop command (ON : Reverse operation command).	O	O	O
2	Multi-speed/position setting command 0	Muti-Spd/Pos Ref 0	Multi-Speed Reference / Position Reference 0	O	O	O
3	Multi-speed/position setting command 1	Muti-Spd/Pos Ref 1	Multi-Speed Reference /Position Reference 1	O	O	O
4	Multi-speed/position setting command 2	Muti-Spd/Pos Ref 2	Multi-Speed Reference /Position Reference 2	O	O	O
5	Multi-speed/position setting command 3	Muti-Spd/Pos Ref 3	Multi-Speed Reference /Position Reference 3	O	O	O
6	Forward jog run command	FJOG	ON : Forward operation in jog mode (00-18).	O	O	O
7	Reverse jog run command	RJOG	ON : Reverse operation in jog mode (00-18).	O	O	O
8	UP frequency increasing command	UP command	ON : Command of output frequency increasing (only used by support of DOWN command).	O	O	O
9	DOWN frequency decreasing command	DOWN command	ON : Command of output frequency decreasing (only used by support of UP command).	O	O	O
10	Acceleration/deceleration time selection 2	Acc/Decel Time Selection 1	Acceleration/deceleration time selection command 1	O	O	O
11	Inhibit Acceleration /deceleration command	ACC/DEC Inhibit	ON : Acceleration/ deceleration prohibition	O	O	O
12	Main/ Alternative Run Switch Function	Run Change Sel	Run Command Source is set in parameter of alternative frequency command (00-03)	O	O	O
13	Main/ Alternative Frequency Switch Function	Freq Change Sel	Frequency Command Source is set in parameter of alternative frequency command (00-06)	O	O	O
14	Emergency Stop (decelerate to zero and stop)	E-Stop	ON : Emergency stop input	O	O	O

Value	Function		Description	Control Mode		
	Name	LCD Display		V/F	SLV	PM SLV
15	External Baseblock Command (rotation freely to stop)	Ext. BB	ON : Inverter base interdiction	○	○	○
16	PID control disable	PID Disable	ON : PID control disabled	○	○	○
17	Fault reset (Reset)	Fault Reset	Fault reset	○	○	○
18	Auto Run Mode Enable		ON : Auto run mode enable(06-00)	-	-	-
19	Speed Search (from the maximum frequency)	Speed Search 1	ON : Search the speed from the maximum output frequency	○	○	X
20	Energy Saving	Energy saving	ON : Manual energy saving control is based on the settings of 11-12 and 11-18.	○	X	X
21	Reset PID Integral Value to Zero	PID I-Reset	ON : PID integral reset	○	○	○
22	Counter Input	Cnt Input	ON : Counter input by digital input	○	○	○
23	Counter Reset	Cnt Reset	ON : Counter reset by digital input	○	○	○
24	PLC Input	PLC Input	ON : PLC input	○	○	○
25	Pulse-In Width Measure (S3)	Pulse Input-Width Measure	ON : Switch S3 to pulse-in width measure	○	○	○
26	Pulse-In Frequency Measure (S3)	Pulse Input-Freqency Measure	ON : Switch S3 to pulse-infrequency measure	○	○	○
27	Local/Remote Selection	Local/Remote	ON : Local mode (via the digital operator) OFF : Frequency command and operation command will be determined according to the setting of parameter (00-02 and 00-05).	○	○	○
28	Remote Mode Selection	Remote Mode Sel	ON : RS-485 communication OFF : Control circuit terminal	○	○	○
29	Jog Frequency Selection	JOG Freq sel	ON : RS-485 communication	○	○	○
30	Reserved	Reserved	Reserved	-	-	-
31	Reserved	Reserved	Reserved	-	-	-
32	Reserved	Reserved	Reserved	-	-	-
33	DC Braking	DC Brake Command	ON : Perform DC braking	○	○	○
34	Speed Search 2 (From The Frequency Command)	Speed Search 2	ON : Search speed from set frequency	○	○	X
35	Reserved	Reserved	Reserved	-	-	-
36	Reserved	Reserved	Reserved	-	-	-
37	Reserved	Reserved	Reserved	-	-	-
38	Reserved	Reserved	Reserved	-	-	-
39	Reserved	Reserved	Reserved	-	-	-
40	Switching Between Motor 1/Motor 2	Motor 2 Switch	ON : Start motor 2	○	○	X
41	PID Sleep	PID Sleep	ON: PID sleep function enabled	○	○	○
42	Reserved	Reserved	Reserved	-	-	-
43	Reserved	Reserved	Reserved	-	-	-
44	Reserved	Reserved	Reserved	-	-	-
45	Reserved	Reserved	Reserved	-	-	-

Value	Function		Description	Control Mode		
	Name	LCD Display		V/F	SLV	PM SLV
46	Reserved	Reserved	Reserved	-	-	-
47	Fire Mode	Fire Mode	ON : Based on max frequency of 01-02 (Fire mode will be stopped by hardware protection such as OC, SC, STO...)	O	O	O
48	KEB Acceleration	KEB Accel.	ON : KEB acceleration start	O	O	O
49	Reserved	Reserved	Reserved	-	-	-
50	Reserved	Reserved	Reserved	-	-	-
51	Reserved	Reserved	Reserved	-	-	-
52	Reserved	Reserved	Reserved	-	-	-
53	Reserved	Reserved	Reserved	-	-	-
54	Reserved	Reserved	Reserved	-	-	-
55	Reserved	Reserved	Reserved	-	-	-
56	Reserved	Reserved	Reserved	-	-	-
57	Forced Frequency Run	Forced Frequency Run	ON : Forced Frequency Run Enable	O	X	X
58	Reserved	Reserved	Reserved	-	-	-
59	Reserved	Reserved	Reserved	-	-	-
60	Reserved	Reserved	Reserved	-	-	-
61	Reserved	Reserved	Reserved	-	-	-
62	Reserved	Reserved	Reserved	-	-	-
63	Switch to Tolerance Range of Constant Pressure 2	Switch to Tolerance Range of Constant Pressure 2	Reserved	O	O	O
64	Reserved	Reserved	Reserved	-	-	-
65	Short-Circuit Breaking	SC Brk	ON : Short-Circuit Breaking turn on	X	X	O
66	PID Control Disable 2	PID Control Disable 2	ON :			
67	Reserve	Reserve	Reserve			
68	External Fault	External Fault	ON : External Fault Input			
69	External Overload	External Overload	ON : External Overload Input			

- | | |
|---|------------|
| (1) 2-wire control forward operation | (03-0X=00) |
| (2) 2-wire control: reverse operation | (03-0X=01) |
| (3) Multi-speed/position setting command 1 | (03-0X=02) |
| (4) Multi-speed/position setting command 2 | (03-0X=03) |
| (5) Multi-speed/position setting command 3 | (03-0X=04) |
| (6) Multi-speed/position setting command 4 | (03-0X=05) |
| (7) Jog frequency selection, select frequency reference using the multi-function digital input. | (03-0X=29) |

Figure 4.3.28 Multi-speed operation selection

Speed	Multi-function digital input (S1 to S6) ^{*4}					Frequency selection
	Jog frequency reference	Multi-speed frequency 3	Multi-speed frequency 2	Multi-speed frequency 1	Multi-speed frequency 0	
1	0	0	0	0	0	Frequency command 0(05-01) or main speed frequency ^{*2}
2	0	0	0	0	1	frequency reference 1 (05-02) ^{*3}
3	0	0	0	1	0	Frequency command 2 (05-03)
4	0	0	0	1	1	Frequency command 3 (05-04)
5	0	0	1	0	0	Frequency command 4 (05-05)
6	0	0	1	0	1	Frequency command 5 (05-06)
7	0	0	1	1	0	Frequency command 6 (05-07)
8	0	0	1	1	1	Frequency command 7 (05-08)
9	0	1	0	0	0	Frequency command 8 (05-09)
10	0	1	0	0	1	Frequency command 9 (05-10)
11	0	1	0	1	0	Frequency command 10(05-11)
12	0	1	0	1	1	Frequency command 11 (05-12)
13	0	1	1	0	0	Frequency command 12 (05-13)
14	0	1	1	0	1	Frequency command 13(05-14)
15	0	1	1	1	0	Frequency command 14 (05-15)
16	0	1	1	1	1	Frequency command 15 (05-16)
17	1 ^{*1}	—	—	—	—	Jog frequency command (00-18)

“0” : OFF, “1” : ON, “-” : Ignore

*1 : Jog frequency terminal has a higher priority than multi-speed reference 1 to 4.

*2 : When parameter 00-05=0 (frequency reference input = digital operator), multi-speed frequency 1 will be set by 05-01 frequency reference setting1). When parameter 00-05=2 (frequency reference input=control circuit terminal), multi-speed frequency command 1 is input through analog command terminal AI1 or AI2).

*3 : Multi-speed operation is disabled when PID is enabled.

Wiring Example :

Figure 4.3.17 and 4.3.18 is the example of a 9 speed operation selection

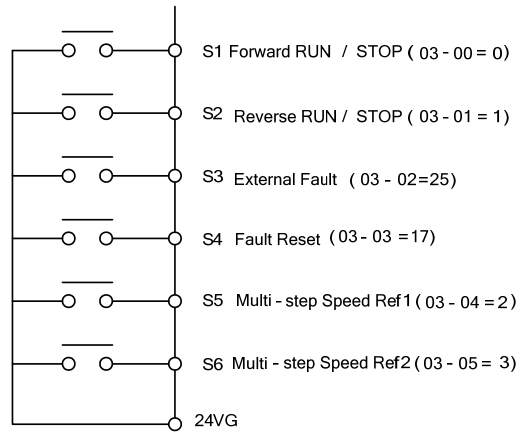

Figure 4.3.17 Control Terminal Wiring Example

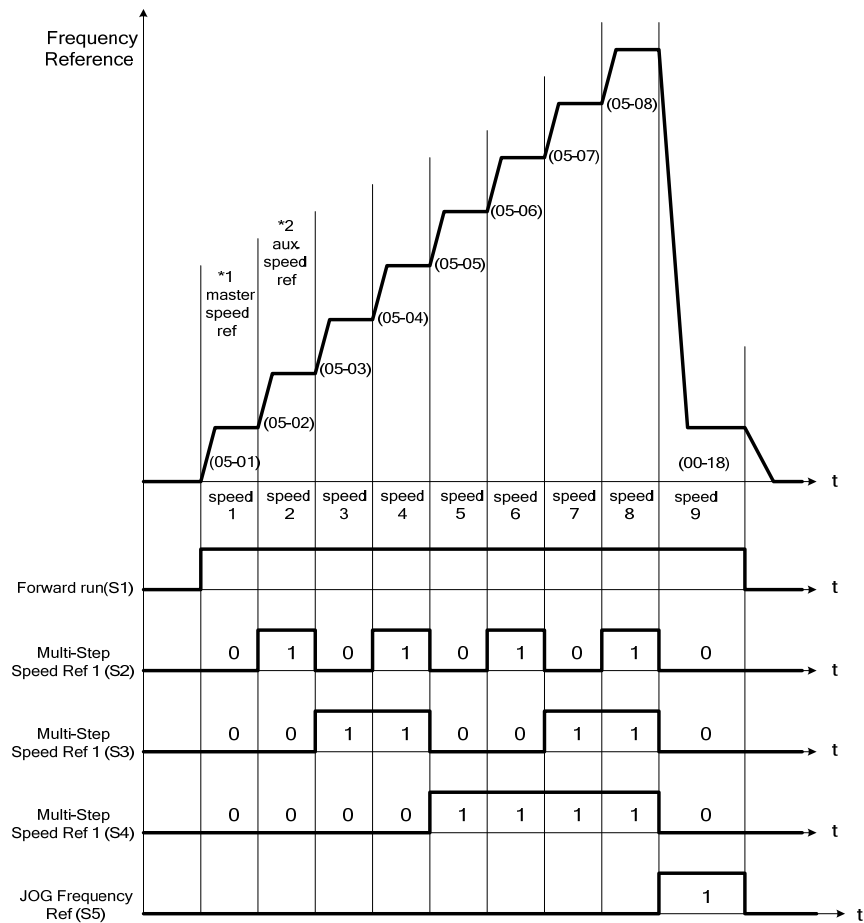

Figure 4.3.18 9-speed timing diagram

*1 : When 00-05=2, multi-speed frequency reference is set by analog input AI1 or AI2.
 When 00-05=0, multi-speed frequency reference is set by 05-01.

(8) Forward jog run command (03-0X=06)

(9) Reverse jog run command (03-0X=07)

- Jog command has a higher priority than other frequency reference commands.
- Jog command uses stop mode set in parameter 07-09 when Jog command is active > 500ms

(10) 03-0X =08 : UP frequency command

(11) 03-0X =09 : Down frequency command

- Inverter can use digital operator and external digital input (S1~S6) to increase or decrease output frequency while motor is running.
- When inverter uses external digital input to perform UP/DOWN, set 00-02=4, 00-05=4 and 03-00~03-05=8 and 9, it requires both UP and DOWN functions 08 and 09 to be programmed to the two digital input terminals.
- UP/DOWN frequency command follows standard acceleration and deceleration times
- “SE02” DI terminal error will be displayed when :
 - ①. When only the UP or DOWN command function is programmed to the digital inputs.
 - ②. When both DOWN command and Inhibit Acceleration/deceleration command are activated simultaneously
 - ③. When both UP command and Inhibit Acceleration/deceleration command are activated simultaneously.
- For the examples of UP/DOWN control wiring and operation, please refer to figure 4.3.19 and figure 4.3.20 .

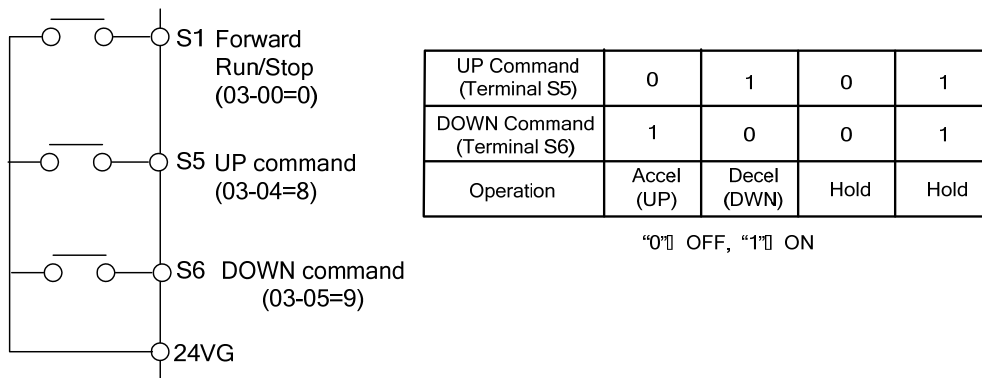

Figure 4.3.19 UP/DOW and operation example

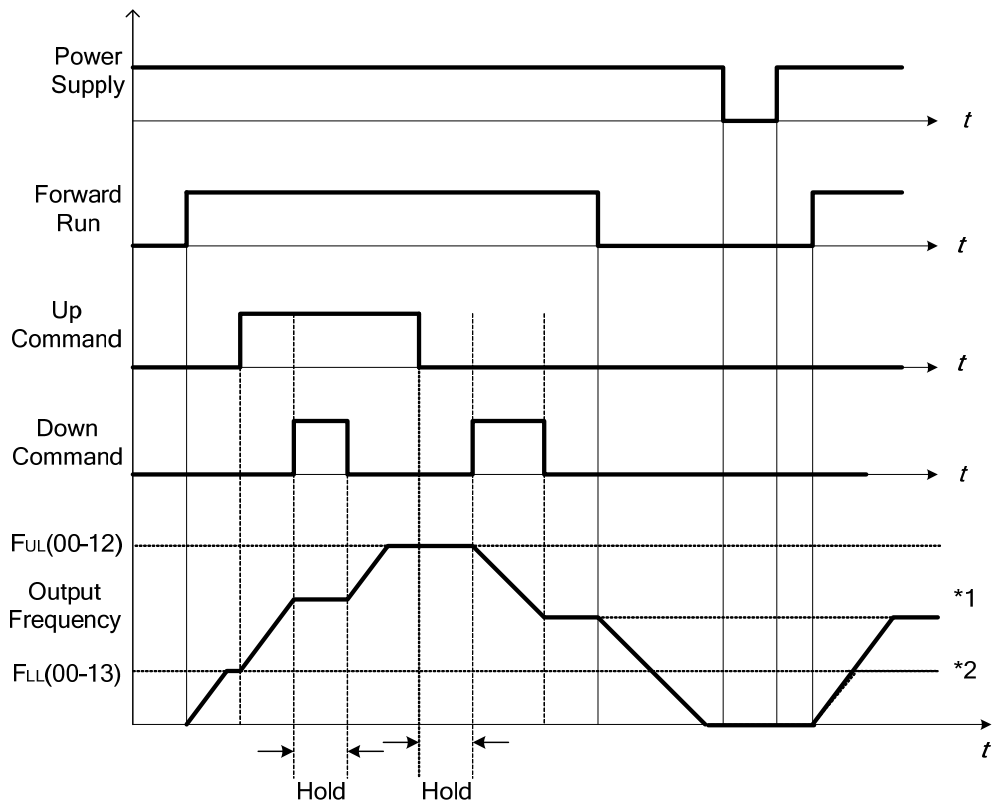

Figure 4.3.20 Up / Down command timing diagram

- When the Forward Run command is active and the UP or Down command is momentarily activated the inverter will accelerate the motor up to the lower limit of the frequency reference (00-13).
- When using the UP / Down command, the output frequency is limited to the upper limit of frequency reference (00-12) and the lower limit of frequency reference (00-13).
- The UP / DOWN command uses acceleration 1 or 2 / deceleration time 1 or 2 for normal operation Tacc1 / Tdec1 (00-14, 00-15) or Tacc2 / Tdec 2 (00-16, 00-17).
- The other applications of UP / Down function, please refer 03-06 (UP/DOWN frequency step).

(12) Acceleration/deceleration 1 selection (03-0X=10)

- Refer to the "multi-function digital input terminals select acceleration / deceleration time".

(13) Inhibit Acceleration/deceleration command (03-0X=11)

- Operation of inhibit Acceleration/deceleration function, please refer figure 4.3.21 .
- The frequency reference value is saved when the acceleration/deceleration inhibit command is active, the frequency reference value is saved even when powering down the inverter.

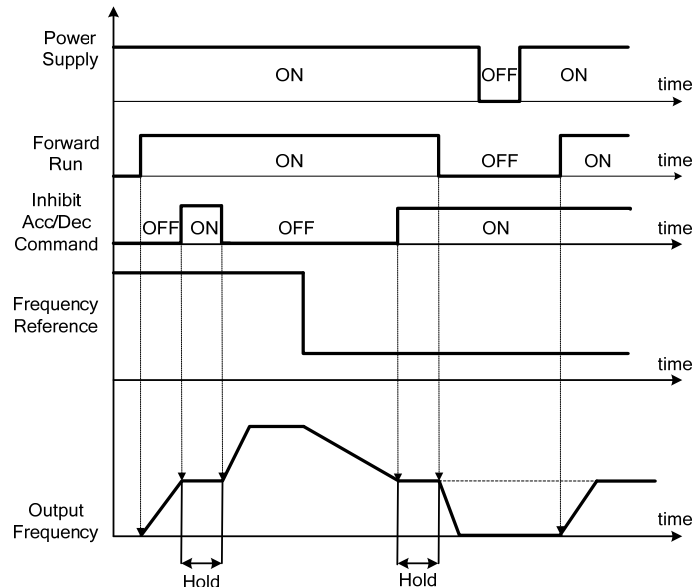

Figure 4.3.21 Inhibit acceleration / deceleration command operation

(14) Main/ Alternative Run Switch Function (03-0X =12)

- When function terminals conduct, run command source is set in alternative run command (00-03). When functional terminal is set to 27 (Local/ Remote control selection), it will be precedential to main/alternative run switch.

(15) Main/ Alternative Frequency Switch Function (03-0X =13)

- When function terminals conduct, frequency command source is set in alternative frequency command (00-06). When functional terminal is set to 27 (Local/ Remote control selection), it will be precedential to main/alternative frequency switch. When PID function is active(10-03=XXX1B), this function is invalid and main frequency is switched to PID function. When PID function is invalid, Main/ Alternative frequency switch function is valid then.

(16) Emergency stop (decelerate to zero and stop) (03-0X =14)

- Refer to the "deceleration time of emergency stop" of parameter 00-26

(17) External Baseblock Command (coast to stop) (03-0X =15)

- Execute the base block command by the use of ON / OFF way of multi-function digital input terminal, and prohibit the inverter output.

During run :

When an external base block command is activated, the keypad displays "BBn BaseBlock (Sn)", indicating the inverter output is turned off (n indicates the digital input number 1 – 6). Upon removing the base block signal, the motor will run at the frequency reference. If speed search from frequency reference is active the inverter output frequency starts from the frequency reference and searches for the coasting motor speed and continue to operate. If speed search is not active the output frequency starts at 0Hz.

During deceleration :

When an external base block command is activated, the keypad displays "BBn BaseBlock (Sn)", indicating the inverter output is turned off (n indicates the digital input number 1 – 8). Upon removing the base block signal, the motor is stopped or will coast to a stop and the inverter will remain in the stop condition.

During acceleration: When an external base block command is activated, the keypad displays "BBn BaseBlock (Sn)", indicating the inverter output is turned off (n indicates the digital input number 1 – 8). Upon removing the base block signal, the motor will run at the frequency reference. If speed search from frequency reference is active the inverter output frequency starts from the frequency reference and searches for the coasting motor speed and continue to operate. If speed search is not active the output frequency starts at 0Hz.

Please refer figure 4.322 for external base block operation ◦

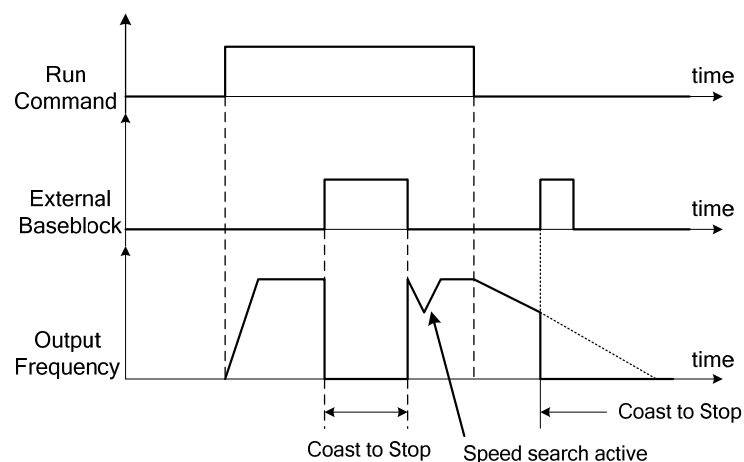

Figur 4.3.22 External base block operation

(18) PID control disabled (03-0X =16)

(19) Fault reset (03-0X =17)

- The output becomes active when the inverter trips on a fault. Upon an inverter fault the inverter output will turn off (base block) and the keypad displays the dedicated fault message. When fault occurs, the following actions can be used to reset the fault:
 - (a) One of the multi-function digital inputs (03-00 to 03-05) to 17 (reset fault) and active input.
 - (b) Press the reset key of the digital operator (RESET).*
 - (c) Recycle power to the inverter.

(20) Auto run mode enable (03-0X=18)

- Digital input set to "18", auto run mode function will be enabled, please refer to group 06.

(21) Speed Search 1 (from the maximum frequency) (03-0X=19)

(22) Energy saving enabled (03-0X=20)

- Manual energy savings function is set with parameters 11-12 and 11-18, for the manual energy saving operation, please refer to figure 4.3.88 ◦

(23) Reset PID integral value to zero (03-0X=21)

(24) Counter Input 1 (03-0X=22)

- When digital input set to "22", the counter value will be added once when the digital input from "OFF" to "ON" status.

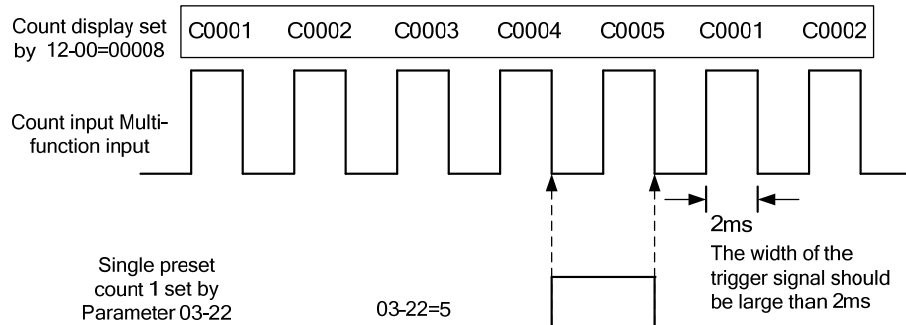

(25) Counter Reset (03-0X=23)

- Counter counts can be reset to 0 at any time by using an external input connected to one of the multi-function inputs (S1~S6) and by setting the relevant parameter (03-00 ~03-05) to 23, inverter will display "C0000". Inverter can receive counter signal again when the reset signal is removed.

(26) PLC Input (03-0X=24)

- When anyone of the external terminals S1 to S6 set to 24 and turned on, the PLC program inputs will be enabled.

(27) Pulse-In Width Measure (S3) (03-0X=25)

- When one of S1~S6 (except S3) set to 25, it will switch pulse width measurement function from S3. In this mode, the pulse input frequency range is 10Hz~200Hz, the other digital input can not set to 26 (pulse input-frequency measurement)

(28) Pulse Input Frequency Measure (03-0X=26)

- When one of S1~S6 (except S3) set to 26, it will switch pulse width measurement function from S3. In this mode, the pulse input frequency range is 0.05kHz~25.00kHz, the other digital input can not set to 25 (pulse input-width measurement)

Note :

The priority of digital input pulse input measurement function is higher than 03-30.

(29) Local/Remote selection (03-0X=27)

- Switch the inverter frequency reference source between Local (keypad) or Remote (control circuit terminals or RS485). Use parameter 00-05 (Main frequency command source selection) and 00-02 (Run command selection) to select the remote source.
- Local/Remote function can be set by one of digital inputs (S3~S6), and be switched by 03-03~03-05 which the parameter setting is to "27". In 3 wire operation control, S1/S2/S3 are reserved for run/stop/forward-reverse operation, please refer the table below.

Note : Local and remote mode only can be switched when inverter stop running.

Input	Mode	Frequency Reference & Run/Stop Command Source
ON	Local mode	<ul style="list-style-type: none"> ➤ Frequency eference and Run-Stop from keypad. ➤ LEDs SEQ and REF are off.
OFF	Remote mode	<ul style="list-style-type: none"> ➤ Frequency reference source selected by parameter 00-05 and Run/Stop source selected by parameter 00-02 ➤ LEDs SEQ and REF are on.

(30) Local/Romote selection (03-0X=28)

- In Remote mode, indicators of SEQ and REF are on; you can use terminals AI1 and AI2 to control the frequency command, and use terminals S1, S2 or communication terminal RS-485 to control the operation command.
- When one of 03-02~03-05=28 (Remote mode selection) · inverter can switch between external terminal source (S1~S6) or communication (RS-485) source. Please refer the figure 4.3.23 ·

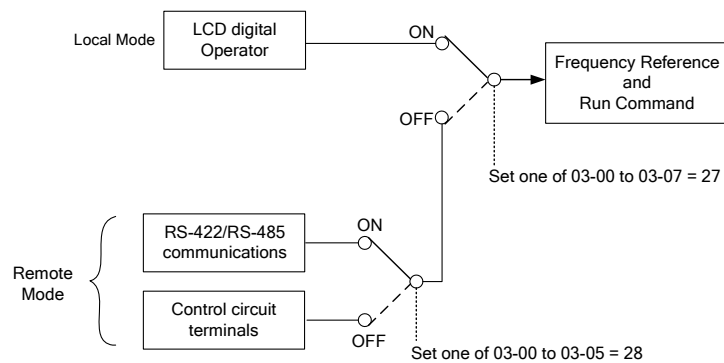

Figure 4.3.23 Remote mode operation selection

(31) Jog Frequency Selection (03-0X=29)

- When jog frequency selection is ON, the inverter will depend on the parameter 00-18 (jog frequency) as the command.

(32) DC Braking (03-0X=33)

- When DC-Injection braking is enabled during start and stop of the inverter.
- DC injection braking is disabled when a run or jog command is active.

Refer to the DC braking time diagram in Figure 4.3.24.

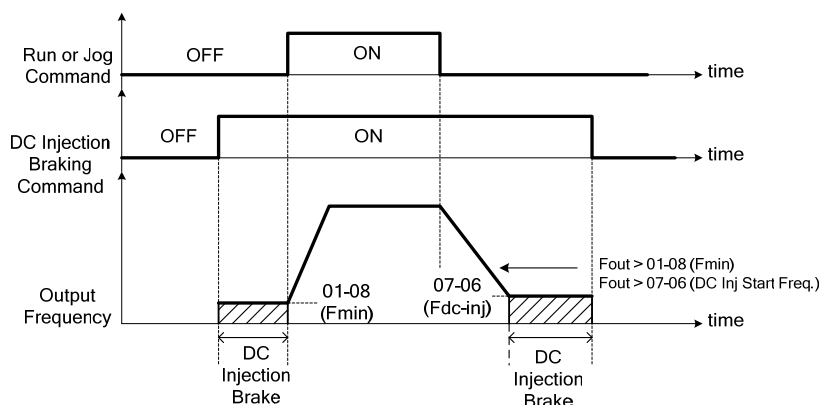

(33) Speed search 2 (03-0X =34)

(34) Switching between motor 1 and motor 2 (03-0X =40)

(35) PID Sleep (03-0X=41)

- Please set 10-29=2 (PID sleep function enabled by digital input) and follow the instructions of 10-27~10-20.

(36) Fire mode (03-0X=47)

- When input is active (03-00~03-05=47) disables all inverter warning and hardware protections. This function is commonly used in commercial applications where the inverter controls an exhaust fan and needs run to destruction in case of a fire.
- When DI terminal becomes to N.C, fire mode will be turned on according to the value of 08-49.

(37) KEB acceleration (03-0X=48)

- When input is active enables KEB (Kinetic Energy Braking) during acceleration. Refer to the parameter description of 11-47 and 11-48. Note: To enable set parameter 11-47 to a value greater than 0.

(38) Forced Frequency Run (03-0X=57)

- This function enables with the corresponding of parameter 23-28 and the source of frequency command of parameter 00-05 set to the value of 5 (PID given, namely the parameter of 10-03 needs to be active.)
- When any one of the multi-function digital input terminal (S1~S6) is set to the value of 16 (the interdiction of PID function), pump will not depend on feedback to do any PID output adjustment; simultaneously another one is set to the value of 57 (forced frequency run) and inverter will have the frequency run setting depending on the parameter of 23-28. Inverter will stop output when digital input terminals (S1~S6) are removed.
- This function is applied to inverter output being controlled by external pressure sensor (eg. differential pressure switch) when pressure sensor disconnects.

(39) Switch to Tolerance Range of Constant Pressure (03-0X=63)

- When using in PUMP mode (23-00=1), the tolerance range of constant pressure (23-09) will be used for walking up the inverter. When digital input terminal enables, the tolerance range of constant pressure 2 (23-24) will be used.

(40) Short-circuit braking (03-0X=65)

- To stop inverter by turning on Short-circuit braking with setting terminal. If executing run command or jog command, short-circuit braking command will erased and start to run. The following picture is short-circuit braking time process.

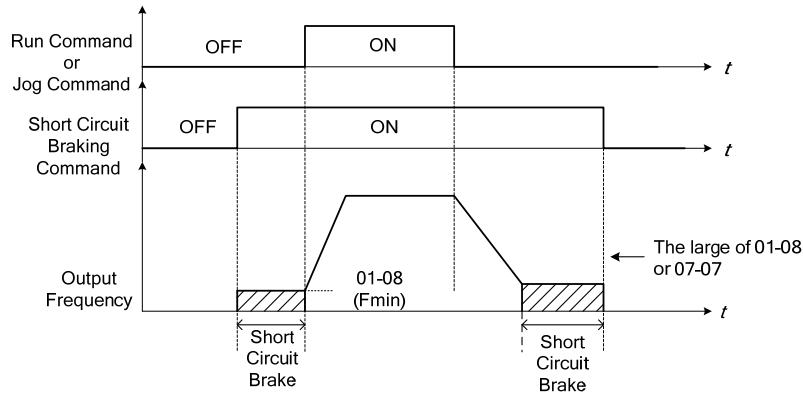

(41) PID Control Disable 2 (03-0X=66)

(42) External Fault (03-0X=68)

- When this function is enabled, inverter will stop running and motor will coast to stop.
- When digital input (S3) set to external fault, keypad will display “EF3 Ext. Fault (S3)”.
- All digital input terminals can be set to external fault.

(43) External Overload (03-0X=69), input terminal is N.C type.

- When this function is enabled, inverter will stop running and motor will coast to stop.
- When digital input (S5) set to external fault, keypad will display “TOL Ext. OverLoad”
- Fire mode needs to be enabled first (08-48=1) when external overload function needs to be used. Only S5 terminal can be set to external overload input.
- External overload function will be set to normal close contact. Please do not set run command from external source.

03- 06	UP/DOWN Frequency Step
Range	【0.00~5.00】 Hz

When 03-06=0Hz, UP/DOWN function will be kept.

When 03-06≠0Hz, frequency command becomes operation frequency plus 03-06 value.

Example :

03- 00=8 (S1 terminal is increasing frequency command)

03- 01=9 (S2 terminal is decreasing frequency command)

03- 06=△Hz

Mode 1 :

When 03-06=0, UP/DOWN function will be kept.

Mode 2 :

When 03-06≠0 and the turned on period is less than 2 secs, for every ON operation frequency changes by △Hz.

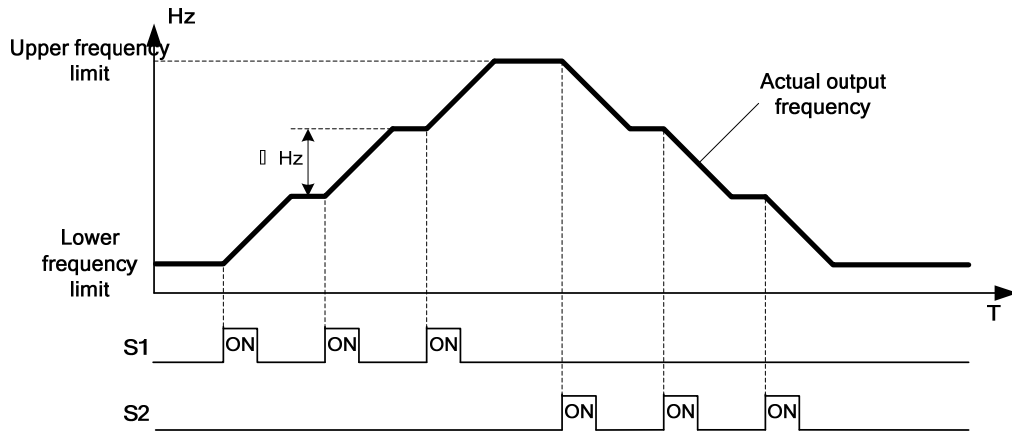

Mode 3 :

When 03-06≠0, and the turned on period is greater than 2 secs, frequency will be changed by acceleration/deceleration time.

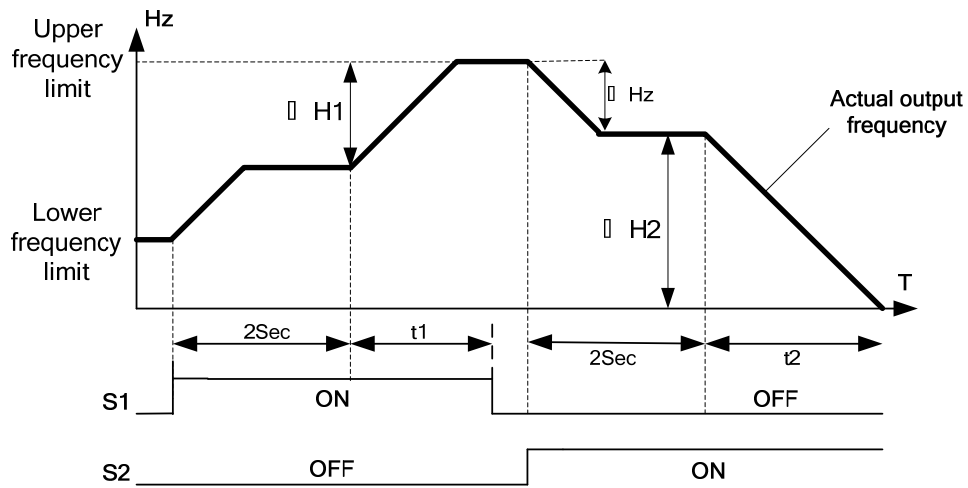

Note :

- △H1 : Difference of acceleration frequency
- t1 : Input terminal turned on time of acceleration time
- △H2 : Difference of deceleration frequency
- t2 : Input terminal turned on time of deceleration time.

$$\Delta H1 = \frac{\text{Upper frequency limit}}{\text{Acceleration time } 2} \times \text{input terminal turned on time (t1)}$$

$$\Delta H2 = \frac{\text{Upper frequency limit}}{\text{Acceleration time } 2} \times \text{input terminal turned on time (t2)}$$

03- 07	UP/DOWN Keep Frequency Status after Stop Command
Range	<p>【0】 : When UP/DOWN is used, the preset frequency is held as the inverter stops, and the UP/DOWN function is disable.</p> <p>【1】 : When UP/DOWN is used, the preset frequency is reset to 0 Hz as the inverter stops.</p> <p>【2】 : When UP/DOWN is used, the preset frequency is held as the inverter stops, and the UP/DOWN is available.</p> <p>【3】 : When acceleration is used, the output frequency will be updated.</p>

- 03-07=0, When run signal is removed (Stop Command), the output frequency is stored in parameter 05-01(Key pad Frequency).
- 03-07=1, when run command is removed, the output frequency of deceleration will be clear.
- 03-07=2, when run command is not available, the UP/DOWN command will be written into frequency command.
- 03-07=3, when frequency command is used, then resend the run command, the frequency command will be updated by operation frequency when you press UP/DOWN key.

03- 08	S1~S6 scan time confirmation
Range	1~200ms

- Multifunction input terminal On/Off periods will be scanned for the number of cycles according to the set value in parameter 03-08. If the signal status for ON or OFF period is less than the set period it will be treated as noise.
- Use this parameter if unstable input signal is expected, however setting long scan time periods results in slower response times.

03- 09	S1~S4 switch type select								
Range	<table style="width: 100%; border: none;"> <tr> <td>【xxx0b】 : S1 A Contact</td> <td>【xxx1b】 : S1 B Contact</td> </tr> <tr> <td>【xx0xb】 : S2 A Contact</td> <td>【xx1xb】 : S2 B Contact</td> </tr> <tr> <td>【x0xxb】 : S3 A Contact</td> <td>【x1xxb】 : S3 B Contact</td> </tr> <tr> <td>【0xxxb】 : S4 A Contact</td> <td>【1xxxb】 : S4 B Contact</td> </tr> </table>	【xxx0b】 : S1 A Contact	【xxx1b】 : S1 B Contact	【xx0xb】 : S2 A Contact	【xx1xb】 : S2 B Contact	【x0xxb】 : S3 A Contact	【x1xxb】 : S3 B Contact	【0xxxb】 : S4 A Contact	【1xxxb】 : S4 B Contact
【xxx0b】 : S1 A Contact	【xxx1b】 : S1 B Contact								
【xx0xb】 : S2 A Contact	【xx1xb】 : S2 B Contact								
【x0xxb】 : S3 A Contact	【x1xxb】 : S3 B Contact								
【0xxxb】 : S4 A Contact	【1xxxb】 : S4 B Contact								
03- 10	S5~S6 switch type select								
Range	<table style="width: 100%; border: none;"> <tr> <td>【xxx0b】 : S5 A Contact</td> <td>【xxx1b】 : S5 B Contact</td> </tr> <tr> <td>【xx0xb】 : S6 A Contact</td> <td>【xx1xb】 : S6 B Contact</td> </tr> </table>	【xxx0b】 : S5 A Contact	【xxx1b】 : S5 B Contact	【xx0xb】 : S6 A Contact	【xx1xb】 : S6 B Contact				
【xxx0b】 : S5 A Contact	【xxx1b】 : S5 B Contact								
【xx0xb】 : S6 A Contact	【xx1xb】 : S6 B Contact								

Parameter 03-09 and 03-10 selects the digital input type between a normally open and a normally closed switch/contact.

Each bit of 03-09/03-10 presents an input :

03-09=	<u>0</u>	<u>0</u>	<u>0</u>	<u>0</u>	0	:	normally open switch
	s4	s3	s2	s1	1	:	normally close switch
03-10=	<u>0</u>	<u>0</u>	<u>0</u>	<u>0</u>	0	:	normally open switch
		s6	s5		1	:	normally close switch

Example : S1 and S2 wired to a normally closed contact/switch set 03- 09=0011 ◦

Note :

Do not set the operation command parameter 00-02 to terminal control before setting the digital input type. Failure to comply may cause death or serious injury.

03-11	Relay (R1A-R1C) output
03-12	Relay (R2A-R2C) output
Range	<p> 【0】 : During Running 【1】 : Fault Contact Output 【2】 : Frequency Agree 【3】 : Setting Frequency Agree (03-13 ± 03-14) 【4】 : Frequency Detection 1 (\geq 03-13, hysteresis range is the setting value of 03-14) 【5】 : Frequency Detection 2 (\leq03-13, hysteresis range is the setting value of 03-14) 【6】 : Automatic Restart 【7】 : Momentary AC Power Loss 【8】 : Rapid Stop 【9】 : Base Block 【10】 : Motor Overload Protection (OL1) 【11】 : Drive Overload Protection (OL2) 【12】 : Over Torque Threshold Level (OT) 【13】 : Preset Output Current Reached 【14】 : Brake Control 【15】 : PID Feedback Signal Loss 【16】 : Single Pre-set Count (03-22~03-23) 【17】 : Dual Pre-set Count (03-22~03-23) 【18】 : PLC Status Indicator (00-02) 【19】 : PLC Control 【20】 : Zero Speed 【30】 : Motor 2 Selection 【37】 : Detection Output of PID Feedback Loss 【54】 : Turn On Short-Circuit Braking 【55】 : Low Current Detection 【59】 : OH Detection </p>

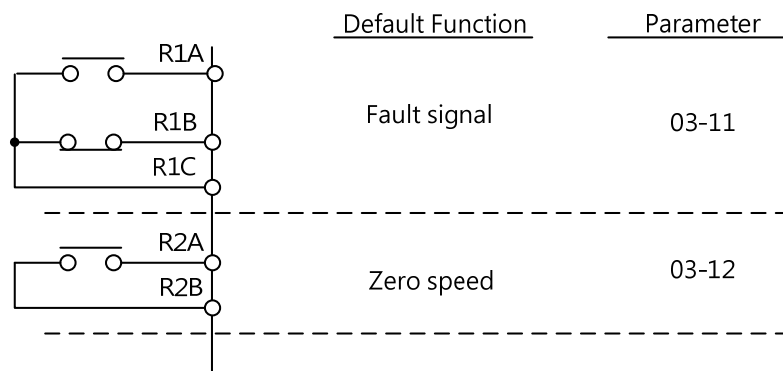

Figure 4.3.25 Multi-function digital output and related parameters

Table 4.3.29 Function table of multi-function digital output

Value	Function		Contents	Control mode		
	Name	LCD display		V/F	SLV	PM SLV
0	During Running	Running	ON : Dring running (Run command is ON)	○	○	○
1	Fault Contact Output	Fault	ON : Fault contact output (except CF00 and CF01)	○	○	○
2	Frequency Agree	Freq. Agree	ON : Frequency agree (frequency agree width detection is set by 03-14)	○	○	○
3	Setting Frequency Agree (03-13 ± 03-14)	Setting Freq Agree	ON : Output frequency = allowed frequency detection level (03-13) ± frequency bandwidth (03-14)	○	○	○
4	Frequency Detection 1 (≥ 03-13, hysteresis range is the setting value of 03-14)	Freq. Detect 1	ON : Output frequency > 03-13, Hysteresis range is 03-14	○	○	○
5	Frequency Detection 2 (≤03-13, hysteresis range is the setting value of 03-14)	Freq. Detect 2	OFF : Output frequency > 03-13, Hysteresis range is 03-14	○	○	○
6	Automatic Restart	Auto Restart	ON : the period of automatic restart	○	○	○
7	Momentary AC Power Loss	Power Loss	ON : Momentary AC Power Loss Happen	○	○	○
8	Rapid Stop	Invalid Do Func.	Reserved	○	○	○
9	Base Block	Baseblock	ON : During Baseblock	○	○	○
10	Motor Overload Protection (OL1)	Invalid Do Func.	Reserved	○	○	○
11	Drive Overload Protection (OL2)	Invalid Do Func.	Reserved	○	○	○
12	Over Torque Threshold Level (OL3)	Over Torque	ON : Over torque detection is ON	○	○	○
13	Preset Output Current Reached	Currebt Agree	ON : When output current > 03-15 is ON	○	○	○
14	Brake Control	Brake E510s	ON : Mechanical braking release frequency OFF : Mechanical braking run frequency	○	○	○
15	PID Feedback Signal Loss	Invalid Do Func.	Reserved	○	○	○
16	Single Pre-set Count (03-22~03-23)	Invalid Do Func.	Reserved	○	○	○
17	Dual Pre-set Count (03-22~03-23)	Invalid Do Func.	Reserved	○	○	○
18	PLC Status Indicator (00-02)	PLC statement	ON : When 00-02 is set to 3 (PLC operation command source)	○	○	○
19	PLC Control	Control From PLC	ON : Control from PLC	○	○	○
20	Zero Speed	Zero Speed	ON : Output frequency < Minimum output frequency (Fmin)	○	○	○
21	Reserved	Reserved	Reserved	-	-	-
22	Reserved	Reserved	Reserved	-	-	-

Value	Function		Contents	Control mode		
	Name	LCD display		V/F	SLV	PM SLV
23	Reserved	Reserved	Reserved	-	-	-
24	Reserved	Reserved	Reserved	-	-	-
25	Reserved	Reserved	Reserved	-	-	-
26	Reserved	Reserved	Reserved	-	-	-
27	Reserved	Reserved	Reserved	-	-	-
28	Reserved	Reserved	Reserved	-	-	-
29	Reserved	Reserved	Reserved	-	-	-
30	Motor 2 Selection	Motor 2 Selection	ON : Switch to Motor 2	O	O	X
31	Reserved	Reserved	Reserved	-	-	-
32	Reserved	Reserved	Reserved	-	-	-
33	Reserved	Reserved	Reserved	-	-	-
34	Reserved	Reserved	Reserved	-	-	-
35	Reserved	Reserved	Reserved	-	-	-
36	Reserved	Reserved	Reserved	-	-	-
37	Detection Output of PID Feedback Loss	PID Fbk Loss	ON : Detection Output of PID Feedback Loss	O	O	O
38	Reserved	Reserved	Reserved	-	-	-
39	Reserved	Reserved	Reserved	-	-	-
40	Reserved	Reserved	Reserved	-	-	-
41	PID Sleep	PID Sleep	ON : PID Sleep	O	O	O
42	Reserved	Reserved	Reserved	-	-	-
43	Reserved	Reserved	Reserved	-	-	-
44	Reserved	Reserved	Reserved	-	-	-
45	Reserved	Reserved	Reserved	-	-	-
46	Reserved	Reserved	Reserved	-	-	-
47	Reserved	Reserved	Reserved	-	-	-
48	Reserved	Reserved	Reserved	-	-	-
49	Reserved	Reserved	Reserved	-	-	-
50	Reserved	Reserved	Reserved	-	-	-
51	Reserved	Reserved	Reserved	-	-	-
52	Reserved	Reserved	Reserved	-	-	-
53	Reserved	Reserved	Reserved	-	-	-
54	Turn On Short-Circuit Braking	SC Brk	ON : Turn on short-circuit braking	X	X	O
55	Low Current Detection	Low Current Detect	ON : Output Current \leq 03-48 Low Current detection level	O	O	O
59	OH Detection	OH Detect Output	ON : OH Detect Output	O	O	O

(1) **During Running (03-1X=0)**

- ON : Run command is ON or output frequency is greater than 0.
- OFF : Run command is OFF and the inverter is stopped.

(2) **Fault Contact Output (03-1X=1)**

- Output is active during fault condition.

- (3) **Frequency Agree (03-1X=2)**
- Output is active when the output frequency falls within the frequency detection width (03-14) of the set frequency detection level (o3-13)
- (4) **Setting Frequency Agree (03-13 ± 03-14) (03-1X=3)**
- Output is active when the output frequency falls within the frequency detection width (03-14) of the set frequency detection level (o3-13).
- (5) **Frequency Detection 1 (\geq 03-13, hysteresis range is the value of 03-14) (03-1X=4)**
- Output is active when the output frequency rises above the frequency detection level (03-13) + frequency detection width (o3-14) and deactivates when the output frequency falls below frequency detection level (o3-13).
- (6) **Frequency Detection 2 (\leq 03-13, hysteresis range is the value of 03-14) (03-1X=5)**
- Output is active when the output frequency is below the frequency detection level (03-13) + frequency detection width (03-14) and turns off when the output frequency falls below frequency detection level.
- (7) **Automatic restart (03-1X=6)**
- Output is active during an auto-restart operation.
- (8) **Momentary AC Power Loss (03-1X=7)**
- Please set 07-01=1 first then this function will be enabled.
 - When momentary AC power loss function is enable, output relay will be ON.
- (9) **Rapid Stop (03-1X=8)**
- Output is active during a rapid stop.
- (10) **Base Block (03-1X=9)**
- Output is active when the inverter output is turned off during a Baseblock command.
- (11) **Motor Overload Protection (OL1) (03-1X=10)**
- Output is active during an overload detection of motor.
- (12) **Drive Overload Protection (OL2) (03-1X=11)**
- Output is active during an overload detection of inverter.
- (13) **Over Torque Threshold Level (OL3) (03-1X=12)**
- Output is active during an over torque detection of inverter.
- (14) **Preset Output Current Reached (03-1X=13)**
- When output current > 03-15 and output current > 03-15 duration > 03-16, it is ON.
- (15) **Brake Control (03-1X=14)**
- Output is active when the brake control is active.

(16) **PID Feedback Signal Loss (03-1X=15)**

- Output is active when PID feedback signal loss.

(17) **PLC Status Indicator (03-1X=18)**

- Output is active when operation command parameter 00-02 is set to PLC control.

(18) **PLC Control (03-1X=19)**

- Output is controlled by the PLC logic.

(19) **Zero Speed (03-1X=20)**

- When zero speed is active, output frequency < minimum output frequency (01-08).
- When zero speed is off, output frequency \geq minimum output frequency.

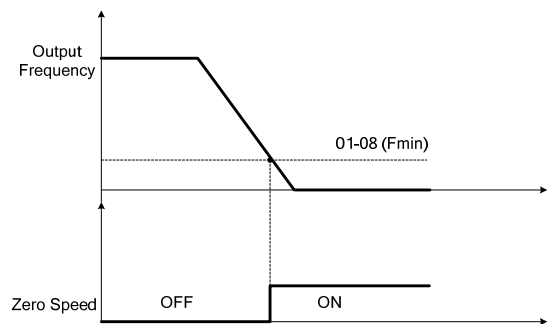

Figure 4.3.26 Zero speed operation

(20) **Motor 2 Selection (03-1X=30)**

- Output is active when motor 2 is selected.

(21) **Detection Output of PID Feedback Loss (03-1X=37)**

- Output is active when PID feedback loss.

(22) **Turn On Short Circuit Braking (03-1X=54)**

- Output is active when turning on short circuit braking.

(23) **Low Current Detection (03-1X=55)**

- Output is active when low current detection function is active.

(24) **OH Detection (03-1X=59)**

- Output is active when temperature setting is agreed.
When inverter temperature higher than the value of 08-46, digital output will become to ON.
When inverter temperature lower than the value of 08-47, digital output will become to OFF.

03-13	Frequency detection Level
Range	【0.0~599.0】 Hz
03-14	Frequency detection width
Range	【0.1~25.5】 Hz

- Frequency detection level : the multi-function output terminals R1A-R1C, R2A-R2C or PH1 (03-11, 03-12) to the desired detection level and bandwidth for use with multi-function output functions 1 to 6.

➤ The time charts of the frequency agree detection operation are shown in table 4.3.30.

Function	Detection operation of frequency confirmation	Description
Frequency agree		<ul style="list-style-type: none"> ➤ Output is active when the output frequency falls within the frequency reference minus the frequency detection width (03-14). ➤ Any of the digital outputs function (03-11, 03-12 or 03-28) can be set to 2 (Frequency agree).
Set frequency agree		<ul style="list-style-type: none"> ➤ Output is active the output frequency falls within the frequency detection width (03-14) of the set frequency detection level (03-13). ➤ Any of the digital outputs function (03-11, 03-12 or 03-28) can be set to 3 (Set frequency agree).
Output frequency detection 1		<ul style="list-style-type: none"> ➤ Output is active when the output frequency rises above the frequency detection level (03-13) + frequency detection width (03-14) and deactivates when the output frequency falls below frequency detection level (03-13). ➤ Any of the digital outputs function (03-11, 03-12 or 03-28) can be set to 4 (Output frequency detection 1).
Output frequency detection 2		<ul style="list-style-type: none"> ➤ Output is active when the output frequency is below the frequency detection level (03-13) + frequency detection width (03-14) and turns off when the output frequency rises above below frequency detection level. ➤ Any of the digital outputs function (03-11, 03-12 or 03-28) can be set to 5 (Output frequency detection 2).
Frequency Output		<ul style="list-style-type: none"> ➤ When the inverter output frequency is active, the output terminal is closed.

03-15	Current Agree Level
Range	【0.1~999.9】 A
03-16	Delay Time of Current Agree Detection
Range	【0.1~10.0】 Sec

- When 03-11=13 and then when the output current > 03-15, output relay will active.
- 03-15 : The suggest setting value is 0.1 to motor rated current.
- 03-16 : The delay time performs depending one the setting value.
- When output current lower than 03-53, delay time from ON to OFF in the signal of relay is 100ms (constant).

Time diagram :

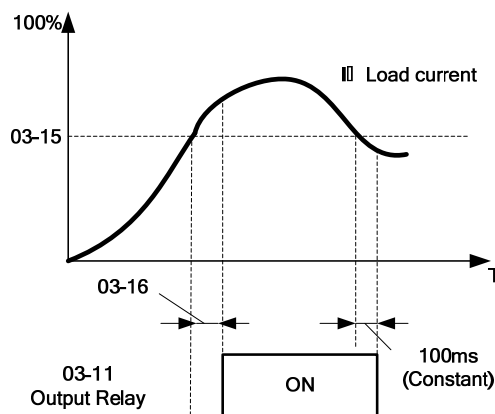

03-17	Machanical Braking Release Level
Range	【0.00~20.00】 Hz
03-18	Machanical Braking Level Set
Range	【0.00~20.00】 Hz

- When 03-11=14,
 - (1) In acceleration mode, output relay will be ON as soon as the actual output frequency reaches the external brake release set in parameter 03-17.
 - (2) In deceleration mode, output relay will be OFF as soon as the actual output frequency reachesthe external brake engage level set in parameter 03-18.

➤ Timing diagram for $03-17 \leq 03-18$ is shown below.

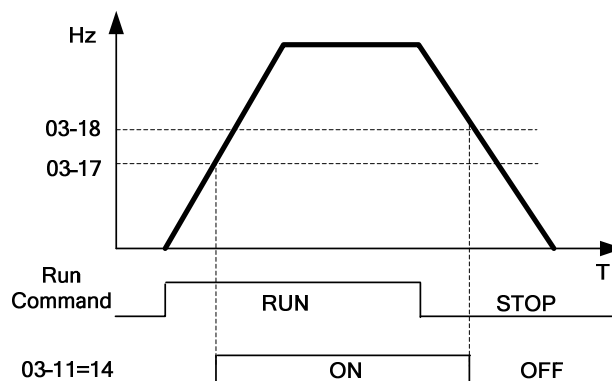

- Time diagram for 03-17 ≥ 03-18 is shown below.

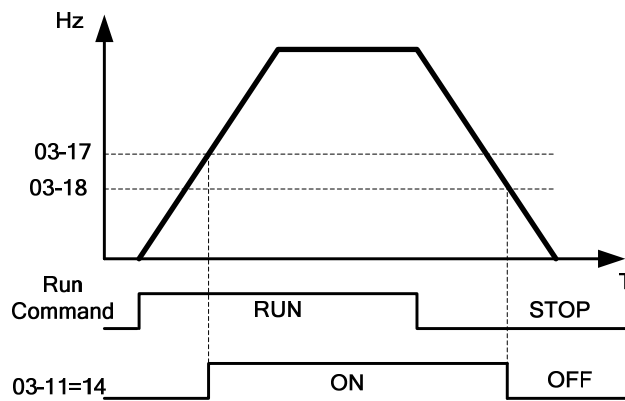

03- 19	Relay (R1A-R2B) Type	
Range	【xxx0b】 : R1 A Contact	【xxx1b】 : R1 B Contact
	【xx0xb】 : R2 A Contact	【xx1xb】 : R2 B Contact

- If 03-19=0, When the set conditions of 03-11,03-12 are met , relay contact is closed.
- If 03-19=1, When the set conditions of 03-11,03-12 are met ,relay contact will open.

03- 20	Internal/External Multi-Function Input Terminal Selection
Range	【0~63】

- The parameter is decided which terminal will be used. (input or output terminal). If you select internal terminal, the corresponded point will be set to 1, if the you select external terminal, the correspond point will be set to 0.

DI	S6	S5	S4	S3	S2	S1
Binary	2 ⁵	2 ⁴	2 ³	2 ²	2 ¹	2 ⁰
Decimal	32	16	8	4	2	1

Each bit of 03- 20 means :

$$03- 20 = \begin{matrix} \underline{0} & \underline{0} & \underline{0} & \underline{0} & \underline{0} & \underline{0} \\ S6 & S5 & S4 & S3 & S2 & S1 \end{matrix}$$

0 : External Multi-function terminal (remote control)

1 : Internal Multi-function terminal (based on 03-21)

Example :

S2、S4、S6 terminal decided to internal multi-function terminal (decided by 03-21)

S1、S3、S5 terminal decided to external multi-function terminal (remote control)

Please set 03-20=101010, summarized the total value of 03-20 is 42 (32+8+2=42).

03- 21	Action to Set The Internal Multi-Function Input Terminals
Range	【0~63】

Each bit of 03- 21 means :

$$03- 21 = \begin{matrix} \underline{0} & \underline{0} & \underline{0} & \underline{0} & \underline{0} & \underline{0} \\ S6 & S5 & S4 & S3 & S2 & S1 \end{matrix}$$

- 0 : Internal Multi-function terminal opened
- 1 : Internal Multi-function terminal closed

Example :

If we need to set S2, S4 closed and S1, S3, S5, S6 opened, please set 03- 21=001010.
summarized the total value of 03-21 is 10 (8+2=10).

03- 22	Setting Counter Agree
Range	【0~9999】
03- 23	Specify Setting Counter Agree
Range	【0~9999】

- 03-22 is used to set the counter value for internal counter, the counter can be enabled by one of multi-digital inputs (03-00~03-05 set to 22), when counter value equal to the value of 03-22, counter value will be reset.
- If the counter needs to re-count when 03-22 value not reached setting value, please set one the multi-digital input to 23 (03-00~03-05=23).
- The status of counter can be monitoring by 12-00=0008.
- Refer to the photo below, if 03-11=17 (Dual Pre-set Count), 03-22=4 (Pre-Set Count 1),03-23=2 (Pre-Set Count 2). When counter cumulative to 2, RY1 will be active. When counter value cumulative to 4, the counter value will be reset when triggered signal is removed.
- If 03-12=16 and 03-22=4, when counter cumulative to 4, RY2 will be active when triggered signal is removed.
- 03-22 value must be higher than 03-23.

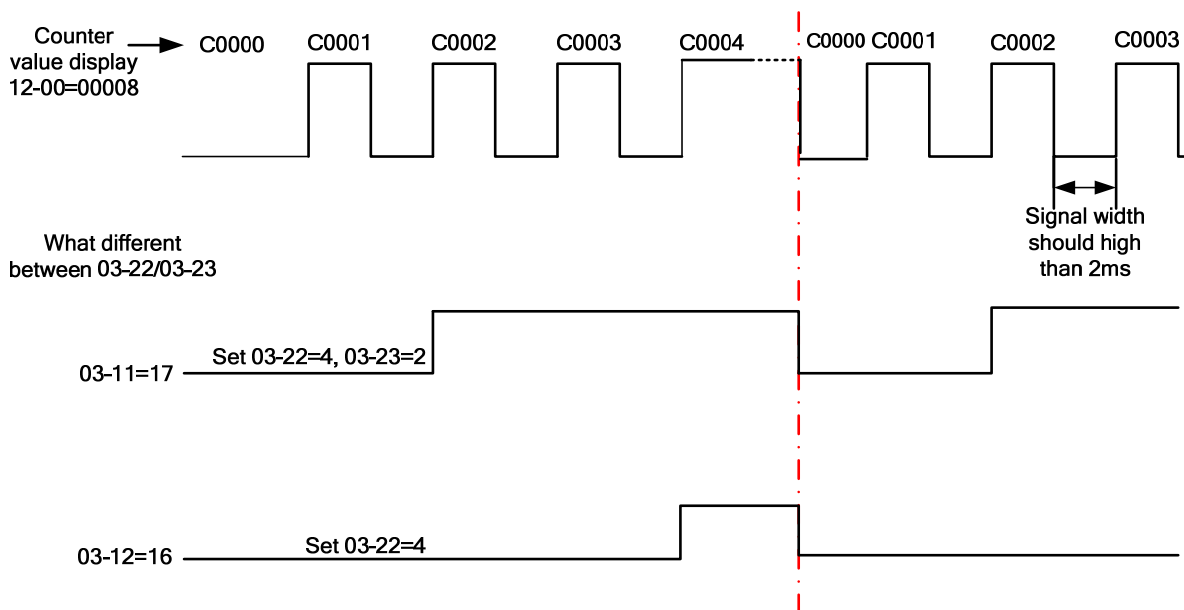

03-24	Output Under Current Detection
Range	【0】 : Invalid 【1】 : Valid
03-25	Output Under Current Detection Level
Range	【0~999.9】 A
03-26	Output Under Current Detection Delay Time
Range	【0.0~655.34】 Sec

- If 03-11=55, when output current \leq 03-25, output relay is active.
- When 03-25=0, the function will be disabled.
- When output current lower than 03-25 for a preset time (03-26), output relay is active. The delay time of output relay from ON to OFF is 100ms (constant).

The timing chart :

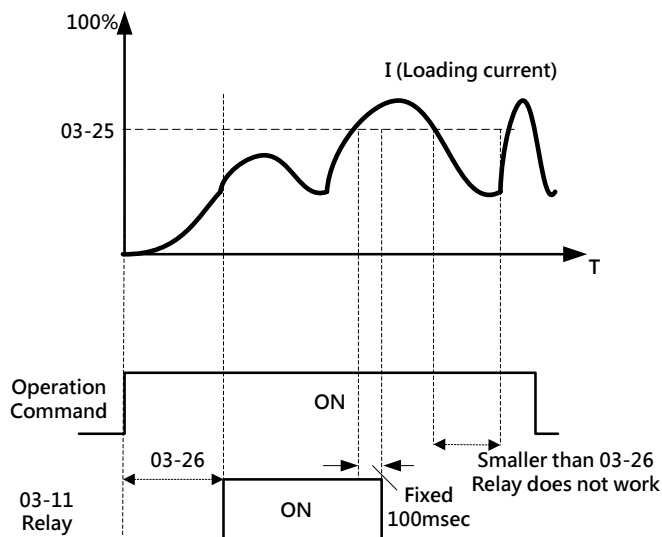

03-27	Pulse Frequency Selection (S3)
Range	50~25000Hz
03-28	Pulse Frequency Gain
Range	【0.0~1000.0】%
03-30	Pulse Input Selection
Range	【0】 : General Pulse input 【1】 : PWM 【2】 : PLC Encoder Input

- There are two ways for pulse input selection :
 - (1) General pulse input :
 $PI = \text{Cutoff frequency} \div \text{pulse input scale set by 03-27}$, corresponding to the maximum output frequency of motor 1 (01-02).
 - (2) PWM : It is required to input the correct frequency
 $PWM = \text{Time of negative edge pulse} \div \text{the time period of pulse}$, corresponding to the maximum output frequency of motor 1 (01-02).

Note :

Deviation of pulse time period in PWM is $\pm 12.5\%$. If it is over the deviation range, pulse input is not active.

Diagram for pulse input selection :

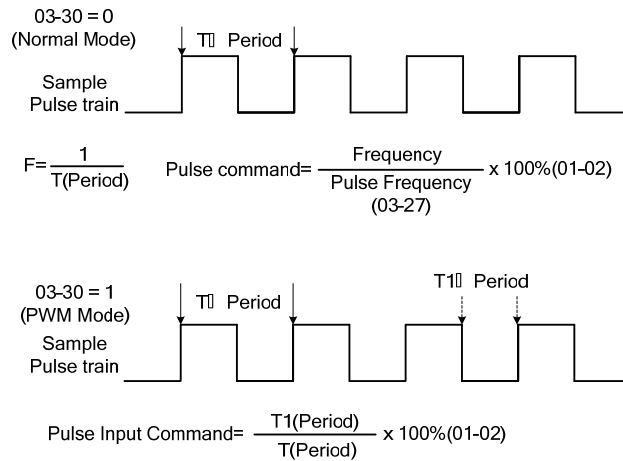

Example of pulse input setting :

1. Normal pulse input (Both NPN/PNP connection can be used)

03-30=0

00-05=7 (Main Frequency Command Source Selection)

03-27=200Hz (Pulse Frequency)

03-28=100.0~1000% (Pulse Input Gain)

When 03-27 with different value, the output frequency of display will be different.

- 03-27=100Hz, 00-12=60.00, 03-28=100.0, keypad display will be 30.00Hz
- 03-27=200Hz, 00-12=60.00, 03-28=100.0, keypad display will be 60.00Hz
- 03-27=100Hz, 00-12=60.00, 03-28=200.0, keypad display will be 60.00Hz

2. PWM Input (NPN connection only)

03-30=1

00-05=7 (Main Frequency Command Source Selection)

03-27=200Hz (Pulse Frequency)

03-28=100.0~1000% (Pulse Input Gain)

When PWM input with different duty, the output frequency of display will be different.

- When 200Hz pulse with 50% duty, 00-12=60.00, 03-28=100.0, keypad display will be $50\% \times 60.00 = 30.00\text{Hz}$.
- When 200Hz pulse with 30% duty, 00-12=60.00, 03-28=200.0, keypad display will be $30\% \times 60.00 \times 2 = 36.00\text{Hz}$.
- When 200Hz pulse with 15% duty, 00-12=599.00, 03-28=500.0, keypad display will be $15\% \times 599.00 \times 5.00 = 449.25\text{Hz}$.

Note :

In this mode, the pulse input frequency range is 10Hz~200 Hz.

Pulse input only can select S3 terminal, also can use NPN or PNP connection.

➤ PNP connection :

PLC pulse output (Y0) connects to S3 terminal, the common terminal of PLC pulse output connects to external 24V terminal of inverter, it's PNP connection.

➤ NPN connection :

PLC pulse output (Y0) connects to S3 terminal, the common terminal of PLC pulse output connects to external COM terminal of inverter, it's PNP connection.

3. PLC Encodert Input

(This function have to collocate with PLC encoder function of DriveLink, only S3 terminal can be set to encoder input channel)

- 03-30=2 (Set S3 terminal to be PLC encoder input source), please refer section 4.4 for encoder input function instruction.

03-33	Pulse Input Bias
Range	【 -100.0~100.0 】 %
03-34	Filter Time of Pulse Input
Range	【 0.00~2.00 】 Sec

- Refer to section 3.4 table 2 control terminals for details.

Refer to figure 4.3.27 for the pulse input specification.

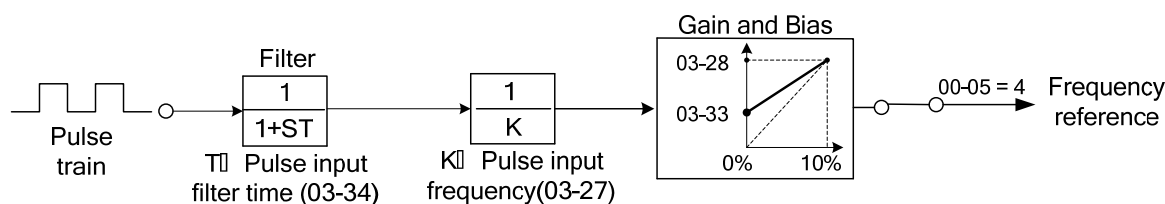

Figure 4.3.27 Pulse input adjustment

- Set Pulse Input Setup as Frequency Reference
- (1) Set parameter 00-05 to 7 and 03-30 to 0 to use the pulse input terminal PI as the frequency, reference source, refer the figure 4.3.5.
 - (2) Set parameter 01-02 (maximum output frequency) and 03-27 (scale of pulse input terminal) PI as the frequency source. Set parameter 03-34 (pulse input filter time) if the performance of inverter is effected.

03-53	Current Agree Level 2
Range	【 0.0~999.9 】 A

03-54	Emergency Stop Action
Range	Run command disable and emergency Stop command disable. 【 0 】 : Restart after Inverter Stop 【 1 】 : Restart after External Reset Command

- (1) 03-54=0 : After the emergency stop command input, it cannot be restarted before the inverter stops. If you need to cancel the emergency stop, please turn off the run command and emergency stop command, and the emergency stop state will be released after the inverter stops.
- (2) 03-54=1 : An additional reset command (DI function: 17) is required to release the emergency stop state.

Group 04 Analog Signal Inputs / Analog Output

04- 00	Analog Input Signal Type								
Range	<table style="width: 100%; border: none;"> <tr> <td style="width: 50%;">【0】 : AI1 0~10V / 0~20mA</td> <td style="width: 50%;">AI2 0~10V / 0~20mA</td> </tr> <tr> <td>【1】 : AI1 0~10V / 0~20mA</td> <td>AI2 2~10V / 4~20mA</td> </tr> <tr> <td>【2】 : AI1 2~10V / 4~20mA</td> <td>AI2 0~10V / 0~20mA</td> </tr> <tr> <td>【3】 : AI1 2~10V / 4~20mA</td> <td>AI2 2~10V / 4~20mA</td> </tr> </table>	【0】 : AI1 0~10V / 0~20mA	AI2 0~10V / 0~20mA	【1】 : AI1 0~10V / 0~20mA	AI2 2~10V / 4~20mA	【2】 : AI1 2~10V / 4~20mA	AI2 0~10V / 0~20mA	【3】 : AI1 2~10V / 4~20mA	AI2 2~10V / 4~20mA
【0】 : AI1 0~10V / 0~20mA	AI2 0~10V / 0~20mA								
【1】 : AI1 0~10V / 0~20mA	AI2 2~10V / 4~20mA								
【2】 : AI1 2~10V / 4~20mA	AI2 0~10V / 0~20mA								
【3】 : AI1 2~10V / 4~20mA	AI2 2~10V / 4~20mA								
04- 01	AI1 Signal Scaling and Filter Time								
Range	【0.00~2.00】 Sec								
04- 02	AI1 Gain								
Range	【0.0~1000.0】 %								
04- 03	AI1 Bias								
Range	【-100~100.0】 %								
04- 05	AI1 Slope								
Range	<table style="width: 100%; border: none;"> <tr> <td style="width: 50%;">【0】 : Positive</td> <td style="width: 50%;"></td> </tr> <tr> <td>【1】 : Negative</td> <td></td> </tr> </table>	【0】 : Positive		【1】 : Negative					
【0】 : Positive									
【1】 : Negative									
04- 06	AI2 Signal Scaling and Filter Time								
Range	<table style="width: 100%; border: none;"> <tr> <td style="width: 50%;">【0】 : Positive</td> <td style="width: 50%;"></td> </tr> <tr> <td>【1】 : Negative</td> <td></td> </tr> </table>	【0】 : Positive		【1】 : Negative					
【0】 : Positive									
【1】 : Negative									
04- 07	AI2 Gain								
Range	【0.0~1000.0】 %								
04- 08	AI2 Bias								
Range	【-100.0~100.0】 %								
04- 10	AI2 Gain								
Range	<table style="width: 100%; border: none;"> <tr> <td style="width: 50%;">【0】 : Positive</td> <td style="width: 50%;"></td> </tr> <tr> <td>【1】 : Negative</td> <td></td> </tr> </table>	【0】 : Positive		【1】 : Negative					
【0】 : Positive									
【1】 : Negative									

- Refer to the follows for 04-00 AI input signal type :
 - If AI1 is 0~10V, switch JP2 of control board to V, set parameter 04-00 to 0 or 1.
 - If AI1 is 2~10V, switch JP2 of control board to V, set parameter 04-00 to 2 or 3.
 - If AI1 is 0~20mA, switch JP2 of control board to I, set parameter 04-00 to 0 or 1.
 - If AI1 is 4~20mA, switch JP2 of control board to I, set parameter 04-00 to 2 or 3.

 - If AI2 is 0~10V, switch JP3 of control board to V, set parameter 04-00 to 1 or 3.
 - If AI2 is 2~10V, switch JP3 of control board to V, set parameter 04-00 to 2 or 4.
 - If AI2 is 0~20mA, switch JP3 of control board to I, set parameter 04-00 to 1 or 3.
 - If AI2 is 4~20mA, switch JP3 of control board to I, set parameter 04-00 to 2 or 4.

- (1) Analog input level adjustment AI1/AI2(04-02, 04-03,04-07, 04-08)
 - Each input signal AI1 and AI2 has a separate gain and bias parameter associated.
 - Analog input signal AI1 can be adjusted with parameter 04-02 and 04-03. Analog input signal AI2 can be adjusted with parameter 04-07 and 04-08.Refer the figure 4.3.35 ◦

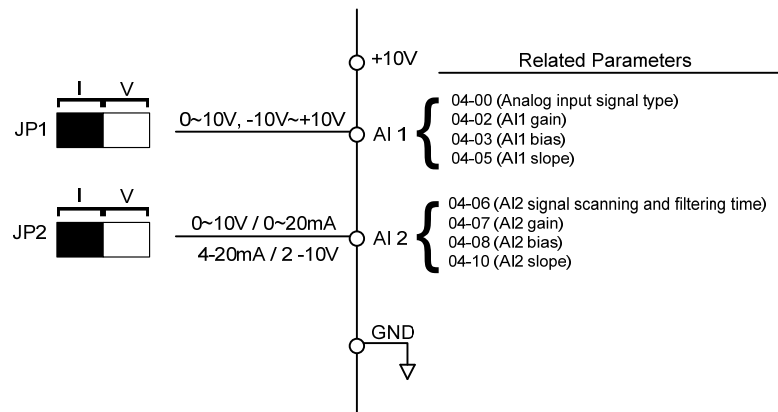

Figure 4.3.35 Analog inputs and related parameters

➤ Please refer fig 4.3.36 for gain and bias operations.

Gain setting :

Sets the level in % that corresponds to a 10V or 20mA signal at the analog input. (Set the maximum output frequency 01-02 to 100 %)

Bias setting :

Sets the level in % that corresponds to a 0V or 4mA signal at the analog input.(Set the maximum output frequency 01-02 to 100%)

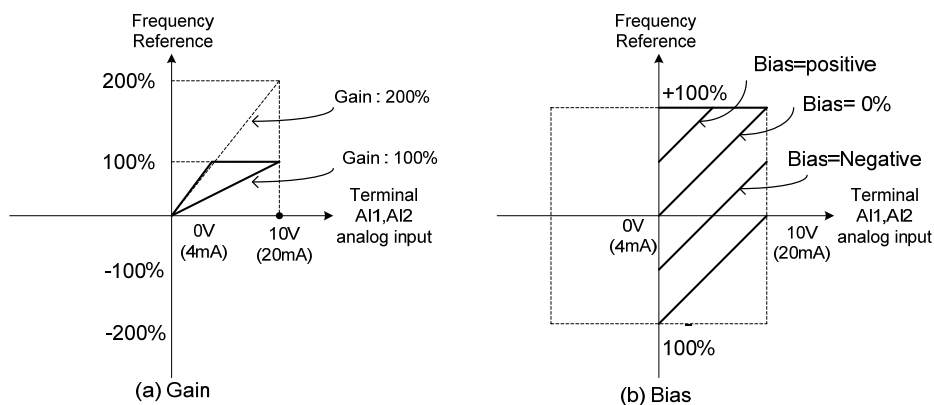

Figure 4.3.36 Gain and bias operations (for frequency reference signal)

(2) AI1 signal scanning and filtering time (04-01)

(3) AI2 signal scanning and filtering time (04-06)

- All analog input (AI1 · AI2) has their own order programmable input filter that can be adjusted when noise is preset on each of the incoming analog signal to prevent erratic drive control.
- The filtering time constant (range : 0.00 to 2.00 seconds) is defined as the time that the input step signal reaches 63% of the final value.

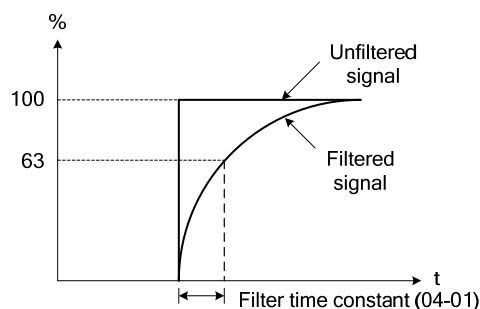

Figure 4.3.37 Filter time constant

04-11	AO function setting
Range	【0】 : Output frequency 【1】 : Frequency command 【2】 : Output voltage 【3】 : DC voltage 【4】 : Output current
04-12	AO gain
Range	【0.0~1000.0】 %
04-13	AO bias
Range	【-100.0~100.0】 %
04-15	AO Slope
Range	【0】 : Positive 【1】 : Negative
04-16	Proportio Gearing function
Range	【0】 : Disable 【1】 : Enable

For the analog output and related parameters, please refer to figure 4.3.50.

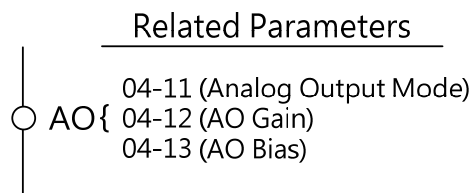

Figure 4.3.50 Analog outputs and related parameters

(1) Analog output adjustment (04-12, 04-13) ◦

- Use parameter 04-12 to select the analog output signal for AO and parameter 04-13 to adjust the bias to AO.
- Adjust the gain so that the analog output (10V) matches 100% of the selected analog output signal.
- Adjust the bias so that the analog output (0V/4mA) matches 0% of selected analog output signal.
- Please refer fig 4.3.51 for analog output level adjustment.

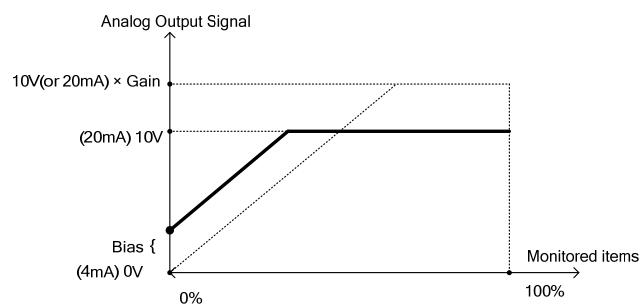

Figure 4.3.51 Analog output level adjustment

(2) Analog output terminal function selection (04-11) ◦

- Please refer to the following table 4.3.33 ◦

Table 4.3.33 Selection of analog output terminals function (04-11)

04-11 parameter setting	Function (Keypad display)	Monitoring Parameters 12 Group	Control Mode		
			VF	SLV	PMSLV
0	Output Freq	12-17	○	○	○
1	Freq Ref	12-16	○	○	○
2	Output Voltage	12-19	○	○	○
3	DC Voltage	12-20	○	○	○
4	Output Current	12-18	○	○	○

(3) F-Gain(04-16) :

- Please refer fig 4.3.52 for F- Gain function, this function provides the facility for setting the frequency reference to more than one inverter set by a master potentiometer then the master frequency can be scaled by three individual potentiometers for each inverter as show in the diagram below.
- Please refer table 4.3.34, when 04-16=1 and 00-05=2, AI1 will be master signal, AI2 will be ratio signal.

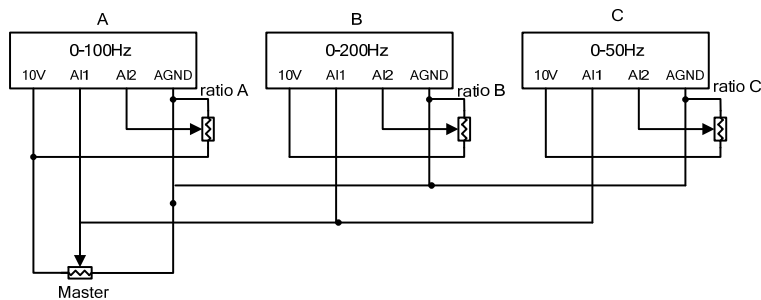

Figure 4.3.52 Example of F-Gain function

Table 4.3.34 Parameter setting of F-Gain

A	B	C
00-05=2	00-05=2	00-05=2
00-12=100	00-12=200	00-12=50
04-16=1	04-16=1	04-16=1

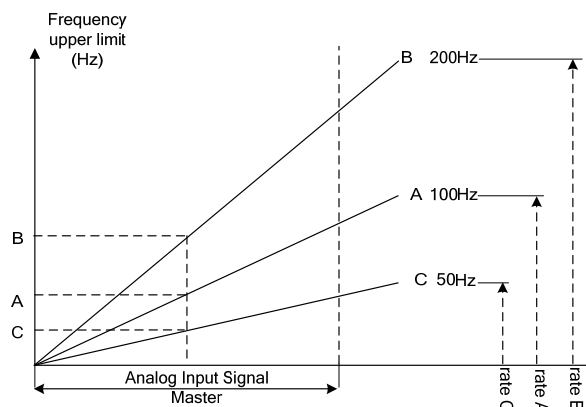

Figure 4.3.53 Diagram of F-Gain function

04-20	AO signal scanning and filtering time
Range	【0.00~0.50】 Sec

- Setting of parameter 04-20 is used for filtering momentary change in analog output signal. When it is enabled, system response will lower down and interference protection will enhance.

04-22	AO Voltage Correction Selection
Range	【0~1】

- This function is used for analog voltage correction. Normally, analog voltage does not need to be correction. If necessary, please connect AO and AI2 terminal and set 04-22=1, inverter will execute analog voltage correction. 04-22 will be cleaned to 0 automatically when voltage correction function finished.

Group 05 Preset Frequency Selection

05- 00	Preset Speed Control Mode Selection
Range	【0】 : Acceleration and deceleration time 1 ~ 4 used. 【1】 : Use independent acceleration and deceleration time for each multi-speed setting.
05- 01	Preset Speed 0
05- 02	Preset Speed 1
05- 03	Preset Speed 2
05- 04	Preset Speed 3
05- 05	Preset Speed 4
05- 06	Preset Speed 5
05- 07	Preset Speed 6
05- 08	Preset Speed 7
05- 09	Preset Speed 8
05- 10	Preset Speed 9
05- 11	Preset Speed 10
05- 12	Preset Speed 11
05- 13	Preset Speed 12
05- 14	Preset Speed 13
05- 15	Preset Speed 14
05- 16	Preset Speed 15
Range	【0.0~599.00】 Hz
05-17	Preser Speed 0-Acc time
05-18	Preser Speed 0-Dec time
05-19	Preser Speed 1-Acc time
05- 20	Preser Speed 1-Dec time
05- 21	Preser Speed 2-Acc time
05- 22	Preser Speed 2-Dec time
05- 23	Preser Speed 3-Acc time
05- 24	Preser Speed 3-Dec time
05- 25	Preser Speed 4-Acc time
05- 26	Preser Speed 4-Dec time
05- 27	Preser Speed 5-Acc time
05- 28	Preser Speed 5-Dec time
05- 29	Preser Speed 6-Acc time
05- 30	Preser Speed 6-Dec time
05- 31	Preser Speed 7-Acc time
05- 32	Preser Speed 7-Dec time
05- 33	Preser Speed 8-Acc time
05- 34	Preser Speed 8-Dec time
05- 35	Preser Speed 9-Acc time
05- 36	Preser Speed 9-Dec time

05- 37	Preser Speed 10-Acc time
05- 38	Preser Speed 10-Dec time
05- 39	Preser Speed 11-Acc time
05- 40	Preser Speed 11-Dec time
05- 41	Preser Speed 12-Acc time
05- 42	Preser Speed 12-Dec time
05- 43	Preser Speed 13-Acc time
05- 44	Preser Speed 13-Dec time
05- 45	Preser Speed 14-Acc time
05- 46	Preser Speed 14-Dec time
05- 47	Preser Speed 15-Acc time
05- 48	Preser Speed 15-Dec time
Range	【0.0~6000.0】 Sec

- When 05-00=0, accel/decal set by parameter 00-14~00-17/00-21~00-24.
- When 05-00=1, individual accel/decal apply to each preset speed 0~15, parameters 05-17~05-48.
- Formula for calculating acceleration and deceleration time :

$$\text{Actual accel time} = \frac{\text{Time of accel 1 or 2 x Preset Frequency}}{\text{Base Frequency}}$$

$$\text{Actual decel time} = \frac{\text{Time of decel 1 or 2 x Preset Frequency}}{\text{Base Frequency}}$$

- When 01-00=F, maximum output frequency set by 01-02.
- When 01-00≠F, maximum output frequency is 50.00 (or 60.00/90.00/120.0/180.0)

Example :

01-00≠F, 01-02=50Hz (maximum output frequency), 05-02=10Hz (presser speed 1),
05-17=5s (Accel-time), 05-18=20s (Decel-time)

$$\text{Preset speed 1 actual accel-time} = \frac{(05-17) \times 10(\text{Hz})}{01-02} = 1(\text{s})$$

$$\text{Preset speed 1 actual decel-time} = \frac{(05-18) \times 10(\text{Hz})}{01-02} = 4(\text{s})$$

Example :

Acceleration/Deceleration timing when 05-00=1 is set to 1.

In this example the following parameters are set :

00-02=1 (External terminal operation)

S1 : 03- 00=0 (Terminal S1 : Forward/stop)

S2 : 03- 01=1 (Terminal S2 : Reverse/stop)

S3 : 03- 02=2 (Terminal S3 : Preset speed 1)

S4 : 03- 03=3 (Terminal S4 : Preset speed 2)

S5 : 03- 03=4 (Terminal S5 : Preset speed 3)

Acceleration/Deceleration calculation of mode 1 :

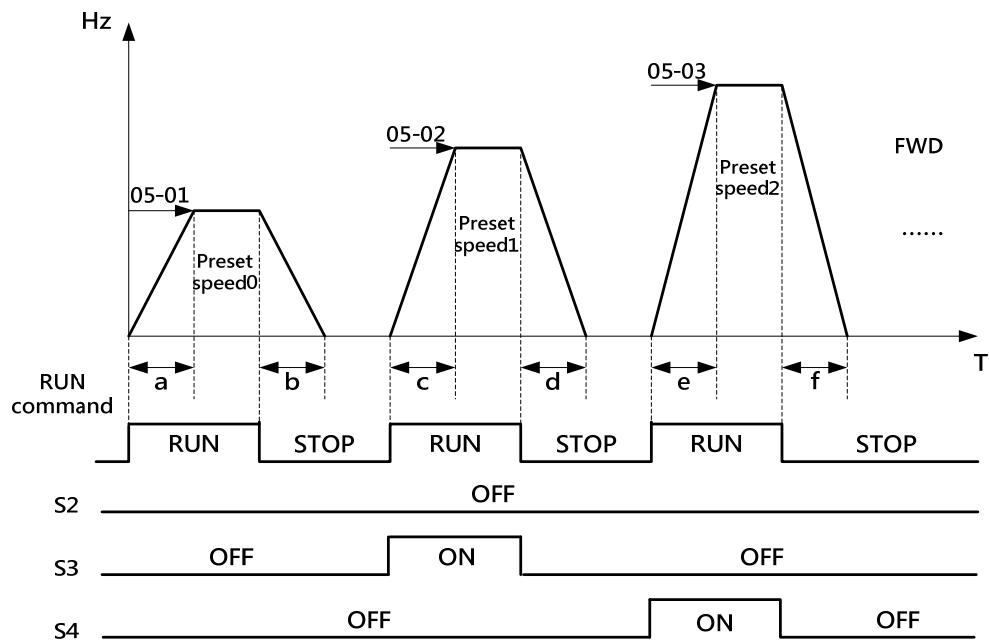

Example :

$$a = \frac{(05-17) \times (05-01)}{01-02}, b = \frac{(05-18) \times (05-01)}{01-02}, c = \frac{(05-19) \times (05-02)}{01-02}$$

$$d = \frac{(05-20) \times (05-02)}{01-02}$$

$$e = \frac{(05-21) \times (05-03)}{01-02}, f = \frac{(05-22) \times (05-03)}{01-02} \dots \text{unit (sec)}$$

Acceleration/Deceleration calculation of mode 2 :

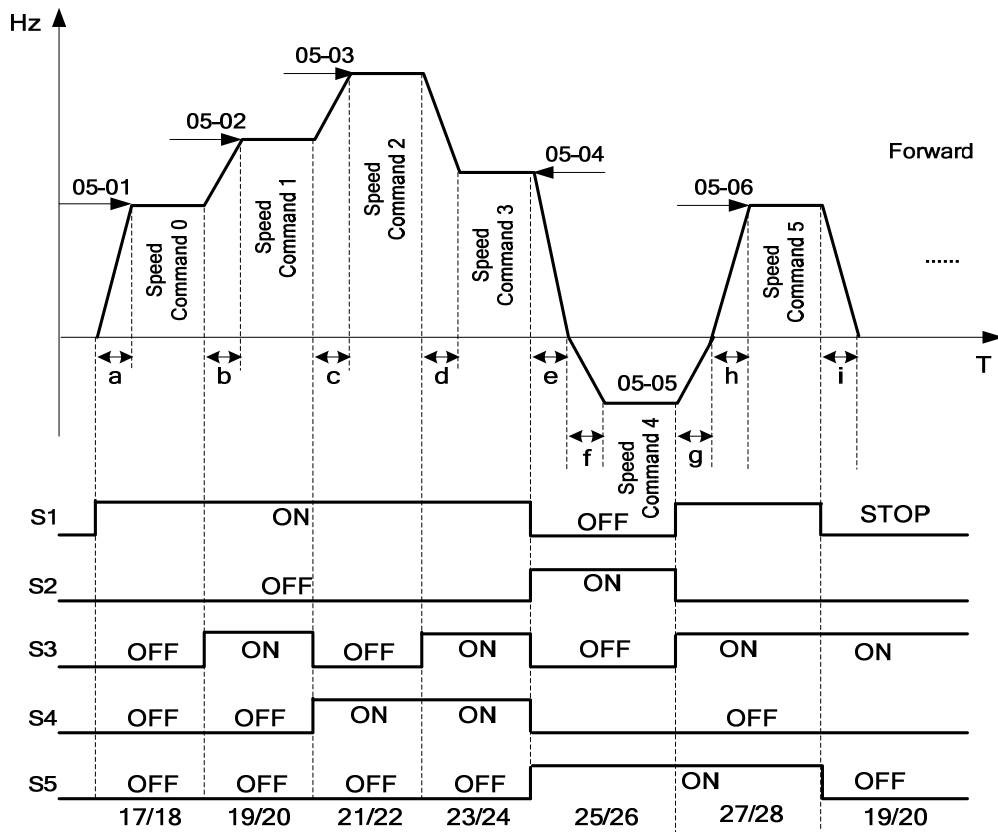

$$a = \frac{(05-17) \times (05-01)}{01-02}, b = \frac{(05-19) \times [(05-02) - (05-01)]}{01-02}$$

$$c = \frac{(05-21) \times [(05-03) - (05-02)]}{01-02}, d = \frac{(05-24) \times [(05-03) - (05-04)]}{01-02}$$

$$e = \frac{(05-26) \times (05-04)}{01-02}, f = \frac{(05-25) \times (05-05)}{01-02}, g = \frac{(05-27) \times (05-05)}{01-02}$$

$$h = \frac{(05-27) \times (05-06)}{01-02}, i = \frac{(05-19) \times (05-06)}{01-02} \dots \text{unit (sec)}$$

Group 06 Automatic Program Operation

06- 00	Auto Run Mode Select
Range	<p>【0】 : Disable</p> <p>【1】 : Execute a single cycle operation. Restart speed is based on the previous stopped speed.</p> <p>【2】 : Execute continuous cycle operation. Restart speed is based on the previous cycle stop speed.</p> <p>【3】 : After completion of a single cycle, the on-going operation speed is based on the speed of the last stage. Restart speed is based on the previous stopped speed.</p> <p>【4】 : Execute a single cycle operation. Restart speed is based on the Speed-Stage 0.</p> <p>【5】 : Execute continuous cycle operation. Restart speed is based on the Speed-Stage 0.</p> <p>【6】 : After completion of a single cycle, the on-going operation speed is based on the speed of the last stage. Restart speed is based on the Speed-Stage 0</p>

Range	【0.00~599.00】 Hz
Frequency setting of speed-stage 0 is based on parameter 05-01	
06- 01	Frequency setting of speed-stage 1
06- 02	Frequency setting of speed-stage 2
06- 03	Frequency setting of speed-stage 3
06- 04	Frequency setting of speed-stage 4
06- 05	Frequency setting of speed-stage 5
06- 06	Frequency setting of speed-stage 6
06- 07	Frequency setting of speed-stage 7
06- 08	Frequency setting of speed-stage 8
06- 09	Frequency setting of speed-stage 9
06- 10	Frequency setting of speed-stage 10
06- 11	Frequency setting of speed-stage 11
06- 12	Frequency setting of speed-stage 12
06- 13	Frequency setting of speed-stage 13
06- 14	Frequency setting of speed-stage 14
06- 15	Frequency setting of speed-stage 15

Range	【0.0~6000.0】 Sec
06- 16	Operation time setting of speed-stage 0
06- 17	Operation time setting of speed-stage 1
06- 18	Operation time setting of speed-stage 2
06- 19	Operation time setting of speed-stage 3
06- 20	Operation time setting of speed-stage 4

06- 21	Operation time setting of speed-stage 5
06- 22	Operation time setting of speed-stage 6
06- 23	Operation time setting of speed-stage 7
06- 24	Operation time setting of speed-stage 8
06- 25	Operation time setting of speed-stage 9
06- 26	Operation time setting of speed-stage 10
06- 27	Operation time setting of speed-stage 11
06- 28	Operation time setting of speed-stage 12
06- 29	Operation time setting of speed-stage 13
06- 30	Operation time setting of speed-stage 14
06- 31	Operation time setting of speed-stage 15

Range	【0】 : Stop 【1】 : Forward 【2】 : Reverse
06- 32	Operation direction selection of speed-stage 0
06- 33	Operation direction selection of speed-stage 1
06- 34	Operation direction selection of speed-stage 2
06- 35	Operation direction selection of speed-stage 3
06- 36	Operation direction selection of speed-stage 4
06- 37	Operation direction selection of speed-stage 5
06- 38	Operation direction selection of speed-stage 6
06- 39	Operation direction selection of speed-stage 7
06- 40	Operation direction selection of speed-stage 8
06- 41	Operation direction selection of speed-stage 9
06- 42	Operation direction selection of speed-stage 10
06- 43	Operation direction selection of speed-stage 11
06- 44	Operation direction selection of speed-stage 12
06- 45	Operation direction selection of speed-stage 13
06- 46	Operation direction selection of speed-stage 14
06- 47	Operation direction selection of speed-stage 15

- Auto run mode uses frequency reference parameters (05-01, 06-01~06-15), operation time parameters (06-16~06-31) and direction of operation parameter (06-32~06-47)
- Auto run mode can not be used when “Wobble Frequency function” or “PID function” is enabled.
- In auto run mode, multi-speed frequency reference of external signal 1~4 (03-00~03-07=2~5) is disabled.

Auto Run examples are shown as following.

(1) Single cycle (06-00=1,4)

The inverter will run for a single full cycle based on the specified number of sequences, then it will stop. In this example, 4 sequences are set, three in forward direction and one in reverse direction.

- 06-00 = 1 (Auto run mode)
- 06-32~06-34 = 1 (Direction of speed stage 0~2)
- 06-47 = 2 (Direction of speed stage 15 is reverse)
- 06-35~06-46 = 0 (Operation direction of stage 3~14 is stop)
- 05-01 = 15Hz (Frequency setting of stage 0)
- 06-01 = 30Hz (Frequency setting of stage 1)
- 06-02 = 50Hz (Frequency setting of stage 2)
- 06-15 = 20Hz (Frequency setting of stage 15)
- 06-16 = 20sec (Operation time of stage 0)
- 06-17 = 25sec (Operation time of stage 1)
- 06-18 = 30sec (Operation time of stage 2)
- 06-31 = 40sec (Operation time of stage 15)

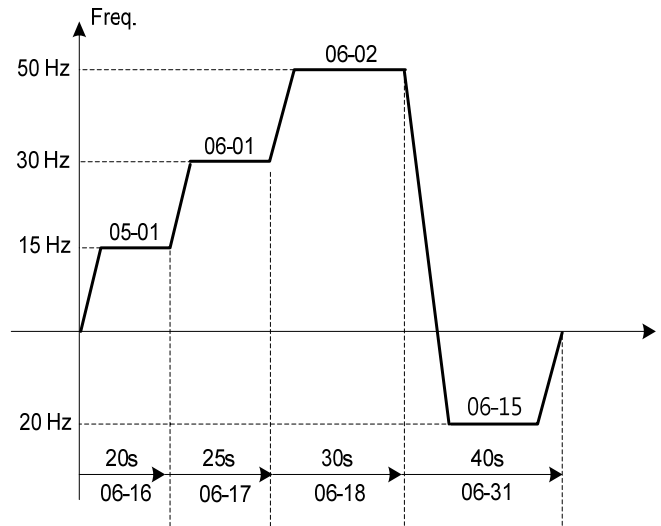

Figure 4.3.52 Single cycle operation (Stop)

(2) Periodic Cycle Run (06-00=2,5)

The inverter will repeat the same cycle periodically. All other parameters are set same as “Example 1” shown above.

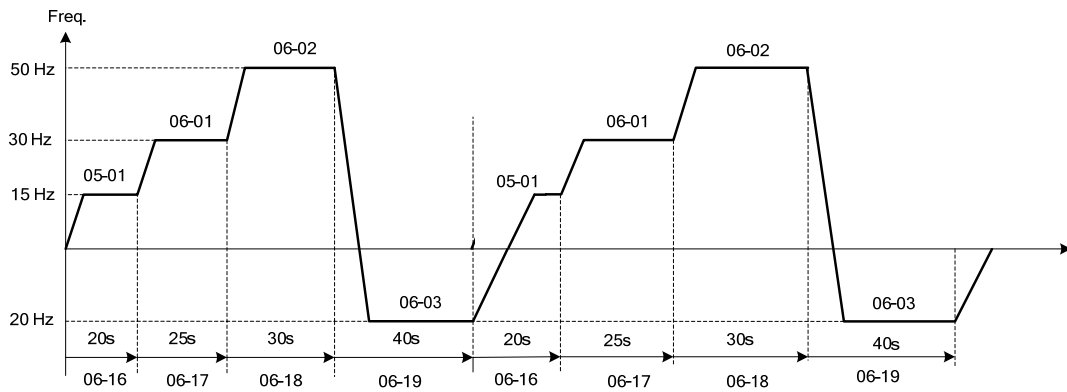
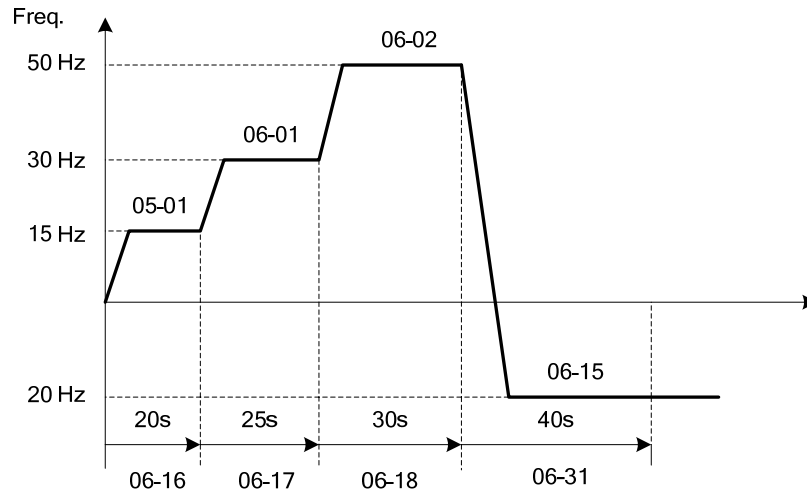

Figure 4.3.53 Periodic cycle run

(3) Auto Run Mode for Single Cycle (06-00=3,6)

The speed of final step will be held to run. (The final step must be put in stage 15)

All other parameters are set same as “Example 1” shown above.



Figur 4.3.54 Auto Run Mode for Single Cycle

- When 06-00=1~3 : After a restart, it continues to run from the unfinished step.
- When 06-00=4~6 : After a restart, it will begin a new cycle.

06-00	1~3	4~6
Output Frequency	<p>Run Command: run, stop, run</p> <p>Output Frequency: (Graph showing frequency ramping up to a peak and then down, then ramping up again from the previous peak level)</p> <p>Continue running from unfinished step</p>	<p>Run Command: run, stop, run</p> <p>Output Frequency: (Graph showing frequency ramping up to a peak and then down, then ramping up again from the start level)</p> <p>begin a new cycle</p>

- ACC/DEC time in Auto run mode will be according to the setting of 00-14/00-15.
- For Auto sequence 0.The run frequency will be according to keypad frequency set by parameter 05-01.Parameters 06-16 and 06-31 are used to set the sequence Run time and Run direction.

Group 07 Start/Stop Parameters

07- 00	Momentary power loss and restart
Range	【0】 : Disable 【1】 : Enable
07- 01	Fault reset time
Range	【0~7200】 Sec
07- 02	Number of restart attempts
Range	【0~10】
07- 03	Reset Mode Setting
Range	【0】 : Enable Reset Only when Run Command is Off 【1】 : Enable Reset when Run Command is On or Off

When 07-00=1, If the input power supply due to sudden increase in supply demand by other equipment results in voltage drops below the under voltage level, the inverter will stop its output at once.

- 07-00=0 : When power loss exceed 2ms, “UV fault” will be detected.
- 07-00=1 : Aafter a momentary power loss, inverter will restart with half frequency before power loss, and there is no limitation on number of restarts.

The automatic restart function is active for the following faults. Please note that when the fault is not listed in the table the inverter will not attempt an automatic restart.

Parameter	Faults	Number of Restart
07-00	UV (Under Voltage)	Unlimited
07-01	OC : Over current OCA : Over current in acceleration OCC : Over current in constant speed OCd : Over current in deceleration OL1 : motor overload UT : Under torque detection IPL : Input phase loss	Depend on parameter 07-02
07-02	GF : Ground failure OV : Overvoltage OL2 : Inverter overload OT : Over-torque detection OPL : Output phase loss CF07 : SLV motor control setting fault CF08 : PMSLV motor control setting fault	

Notes :

- (1) Fault restart function contains momentary power loss restart and auto reset restart.
- (2) Refer to chapter 10 for the details of troubleshooting and fault diagnostics.
- (3) Refer to speed search function (07-19~07-24) for the selection of speed search modes.

➤ **Fault reset time (07-01)**

Restart time of momentary power loss is the same as Fault reset time.

07-01 < 07-18 : Automatic restart time interval is set by minimum baseblock time (07-18).

07-01 > 07-18 : Automatic restart time interval is set by fault reset time (07-01).

Note:

Automatic restart time interval is time of 07-18 plus 07-01 and delay time of speed search (07-22).

Refer to Figure 4.3.55 for automatic restart interval.

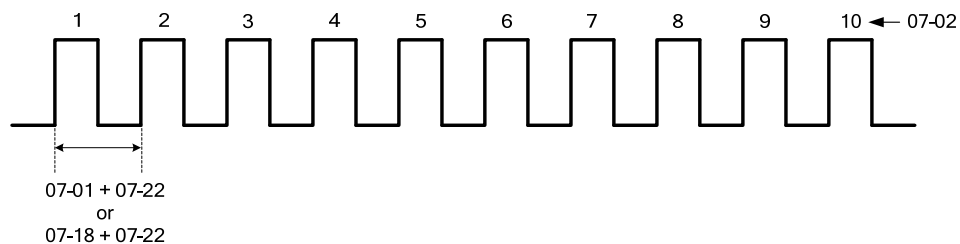

Figure 4.3.55 Automatic restart interval

➤ **Number of restart attempts (07-02)**

If numbers of fault reset reaches the setting value of 07-02, then inverter stops running. So manual to restart the inverter after eliminating fault causes.

When the automatic restart function is enabled the internal automatic restart attempt counter is reset to 0 based on the following actions °

- (1) No fault occurs in 10 minutes or longer after the automatic restart
- (2) Reset command to clear fault via input terminal or using keypad (press reset/◀ key)
- (3) Power to the inverter is turned off and back on again

Note :

Multi-function digital output R1A-R1C, R2A-R2B, or optocoupler output can be programmed to activate during an automatic reset attempt, refer to parameter 03-11, 03-12.

➤ **Automatic restart operation :**

- (1) Fault is detected. The inverter turn off the output, displays the fault on the keypad and waits for the minimum baseblock time parameter 07-18 to expire before accepting another run /automatic restart command.
- (2) After the minimum baseblock time (07-18) and delay time of speed search have expired, the active fault is reset and a speed search operation is performed. The time between each fault restart attempt is set by parameter 07-01.
- (3) When the total number of restart attempts exceed the number of automatic restart attempts set in parameter 07-02, the inverter will turn off the output and the fault contact is activated.

Please refer to figure 4.3.56 for the automatic restart operation.

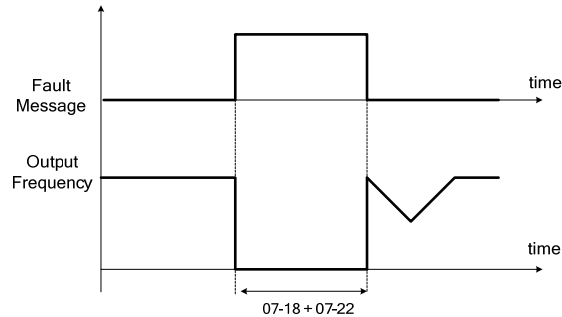

Figure 4.3.56 Auto-restart operation

➤ **Reset Mode Setting (07-03)**

When 07-03=0, after inverter fault detection, the input power must be turned off and then turn on to perform reset function. Otherwise, inverter can not be restarted.

(When 00-02=1, reset mode function is active)

Important : Inverter will be damaged when auto restart function executes frequently.

07- 04	Momentary Power Loss and Restart
Range	【0】 : Enable Direct Running on Power Up 【1】 : Disable Direct Running on Power Up
07- 05	Delay-ON Timer
Range	【1.0~300.0】 Sec

➤ **Momentary Power Loss and Restart (07-04)**

07-04=0 : When direct run on power up is selected by 07-04=0 and the inverter is set to external run by (00-02/00-03=1), if the run switch is ON as power is applied, the inverter will auto start.

07-04=1 : When direct run on power up is disabled by 07-04=1 and if the inverter is set to external run by (00-02/00-03=1), if the run switch is ON as power is applied, the inverter will not auto start and the display will flash with STP1. It will be necessary to turn OFF the run switch and then turn ON again to start normally

➤ **Delay-ON Timer (07-05)**

If 07-04=0, it will count the delay time set by 07-05 first when the inverter starts directly at power on. When the delay time is completed, it starts to run.

! DANGER :

When 07-04=0 and the external run is set (00-02/00-03=1)

If the operation switch is conducted at power up, the inverter starts automatically. It is suggested to turn off the power switch and operation switch at power failure to avoid the damage to the user or the machine when the inverter reconnects.

When 07-04=1 and the external run is set (00-02/00-03=1)

If the operation switch is not conducted at power up, the inverter is not able to start and the warning signal of STP1 flashes. It is required to turn off the operation switch first and they delay of direct start at power up is completed. The make it be conducted to start the inverter.

07- 06	DC Injection Braking Start Frequency
Range	【0.0~10.0】 Hz

➤ The braking act according to the different control modes (00-00), please refer to the following descriptions

(1) When control mode is V/F or SLV (00-00=0, 2) :

➤ It start DC injection braking by the time 07-16. Deceleration to stop is according to 07-06 and 07-08. When output frequency is lower than 07-06 in deceleration time, it start DC injection braking by the time 07-08.

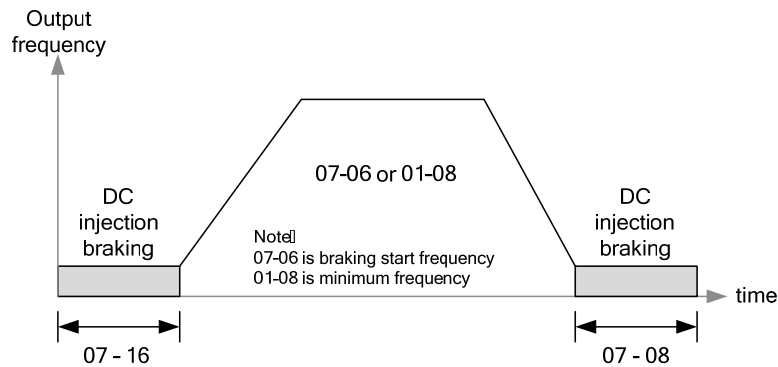

Figure 4.3.57a VF and SLV DC injection braking

Note : When 07-06 < 01-08, it start DC injection braking by the setting frequency (01-08).

(2) When control mode is PMSLV (00-00=5) :

- Please refer fig 4.3.57b for short-circuit braking function.
- DC braking current level is setting by parameter 07-07, based on 100% rated current of inverter. Besides, if the DC braking current level is higher than motor rated current, DC braking current will be locked at motor rated current.
- Short-circuit braking current limit is setting by parameter 07-36, based on 100% rated current of inverter.

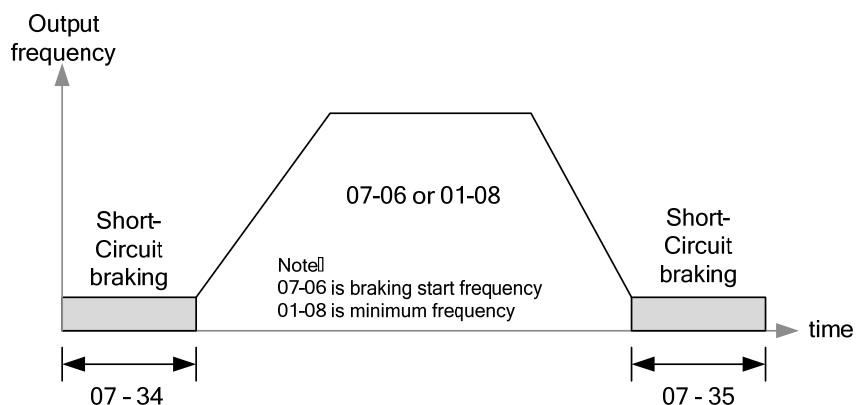

Figure 4.3.57b PMSLV short-circuit braking

Note :

When 07-06 < 01-08, it start short-circuit braking by the setting frequency (01-08)

07- 07	DC Injection Braking Level
Range	【0~100】 %
07- 08	DC Injection Braking time
Range	【0.00~100.00】 Sec
07- 16	DC injection braking time at start
Range	【0.00~100.00】 Sec

- Set parameter 07-06, 07-08 and 07-16 for DC injection braking related function.
- When inverter executes speed search function, DC injection braking function should be disabled.
- To enable DC injection braking during a start operation set the DC injection braking current (07-07) and the DC injection braking time (07-16) at start to a value greater than 0. DC injection braking at start can be used to prevent “wind milling effect” in fan applications.
- To enable DC injection braking during a stop operation set the DC injection braking current (07-07) and the DC injection braking time at stop (07-08) to a value greater than 0.
- When parameter 07-16 is set to 0 sec (DC injection braking off). the inverter will start from the minimum output frequency duration of DC injection braking during a stop operation. DC injection braking at stop is disabled when parameter 07-08 is set to 0 sec. If output frequency is less than 07-06, injection braking function will be enabled. Inverter output will be cut off and then DC injection braking is started.
- During stop operation: If the DC braking start frequency < minimum output frequency (01-08), DC braking is active when the output frequency reaches the minimum output frequency level.
- DC injection braking level can be set by parameter 07-07 in acceleration and deceleration, DC injection current can be part of output rated current. (Suppose rated current of inverter is 100%)
- Increasing the DC braking current (07-07) can reduce the motor stop time.
- DC braking operation can be controlled via any one of the multi-function input terminals(03-00 to 05) function 33. Refer to figure 4.3.57 for DC braking operation.

07- 34	Start short-circuit braking time
Range	【0.00~100.00】 Sec
07- 35	Stop Short-circuit braking time
Range	【0.00~100.00】 Sec
07- 36	Short-circuit braking current limited
Range	【0.0~200.0】 %

- PMSLV is available for short-circuit braking. Short-circuit braking is the way to switch IGBT to produce braking torque. 07-06, 07-34 and 07-36 can adjust the braking process.
- If 07-35=0, Inverter start from the minimum frequency.
- The value of 07-36 is depend on differential motor rated current.
- 03-00~03-07=65 can control Short-circuit braking.

07- 09	Stop Mode Selection
Range	【0】 : Deceleration to stop 【1】 : Coast to stop 【2】 : DC braking to stop 【3】 : Coast to stop with timer

When a stop command is issued the inverter stops according to the stop mode selected. There are four types of stop modes.

Note : PM motor only can select “deceleration to stop mode” and “coast to stop mode”.

(1) 07-09=0 : Deceleration to stop

- When a stop command is issued, the motor will decelerate to the minimum output frequency (01-08) Fmin and then stop. Deceleration rate depends on the deceleration ime (factory default is 00-15).
- When the output frequency reaches the DC braking stop frequency (07-06) or the minimum output frequency (01-08), DC injection braking is activated and the motor stops.

$$\text{Deceleration time} = \frac{\text{Output frequency when stop command is issued}}{\text{Maximum output frequency (01-02)}} \times \text{deceleration time setting}$$

S curve setting will add to the overall stop time, refer to figure 4.3.58

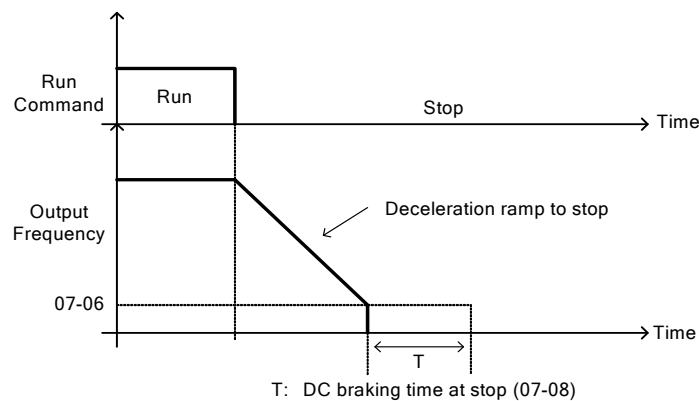

Figure 4.3.58 Deceleration to stop

(2) 07-09=1 : Coast to stop

- When a stop command is issued, the motor will coast to a stop. Stop time depends on motor load and friction of the system.
- The inverter waits for the time set in the minimum baseblock time (07-18) before accepting the next run command.
- In SLV mode (00-00=2) the speed search function is automatically enabled upon the next run command. If the mechanical braking will be used to stop the motor when run command is removed, please set 07-26=1.

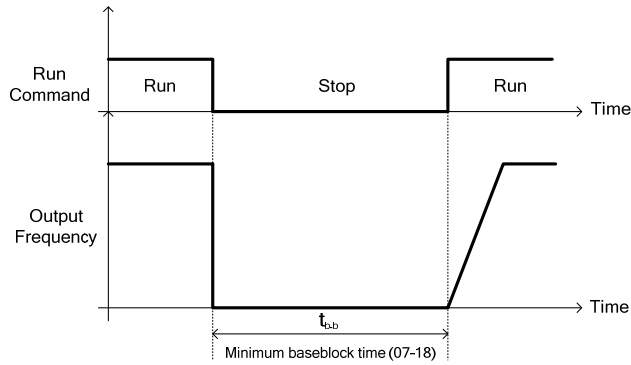

Figure 4.3.59 Coast to Stop

(3) 07-09=2 : DC braking to stop

- When a stop command is issued, the inverter will turn off the output (Baseblock) and after the minimum Baseblock time (07-18) has expired activate DC braking (07-07).
- The DC braking time (t_{DCDB}) of Figure 4.4.60 is determined by the value of 07-08 (DC Braking start time) and the output frequency at the time the stop command was issued.

$$t_{DCDB} = \frac{(07-08) \times 10 \times \text{Output Frequency}}{F_{MAX}(01-02)}$$

- Increase the minimum Baseblock time (07-18) in case an Overcurrent trip occurs during the DC braking.

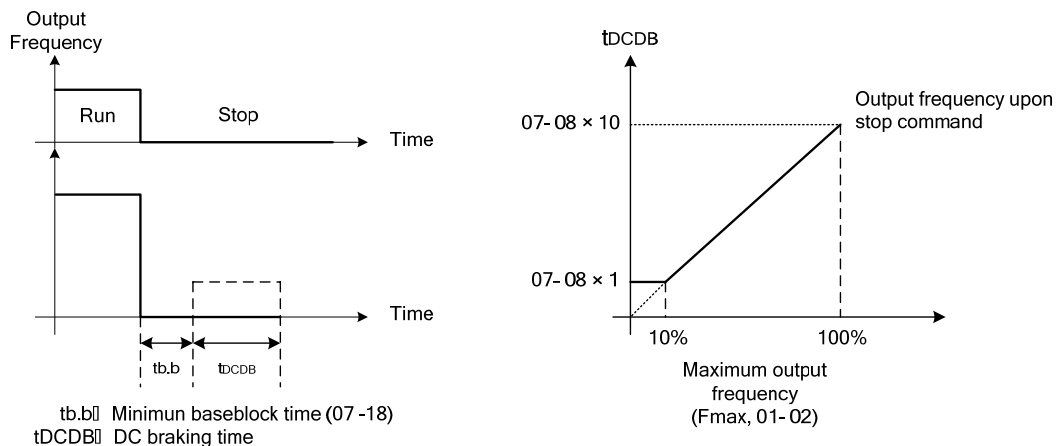

Figure 4.3.60 DC braking to stop

(4) 07-09=3 : Coast to stop with timer

- When a stop command is issued the motor will coast to a stop after the minimum Baseblock time (07-18) has expired. The inverter ignores the run command until the total time of the timer has expired.
- The total time of the timer is determined by the deceleration time (00-15, 17, 22 or 24) and the output frequency upon stop.
- Refer to figure 4.3.61.

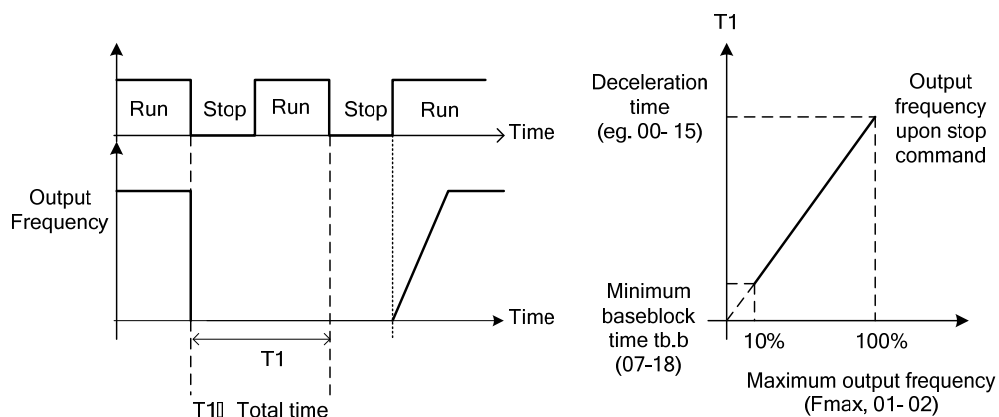

Figure 4.3.61 Coast to stop with timer

07- 10	Speed Search Mode Selection
Range	【0】 : Disable 【1】 : Execute speed search once 【2】 : Speed Search Start

- Speed search function is used to find the speed of a coasting motor and continue operation from that point. The speed search function is active after a momentary power loss.
- (1) When 07-10=0, the inverter start to run from the lowest output frequency but it won't limit the other functions of trigger speed search.
- (2) When 07-10=1, the inverter executes a speed search at power on when entering first run command. It start the motor from found frequency.
- (3) When 07-10=2, the speed search function is performed every time when the run command in input.

Notes :

When 00-00=5 (PMSLV control mode), Frame1 and Frame2 models without this function.

07- 13	Low voltage detection level
Range	【200V Class : 150~300V】 【400V Class : 250~600V】
07- 25	Low voltage detection time
Range	【0.00~1.00】 Sec

- Adjust the 07-13 voltage level from 150 to 300 Vdc (200V class) or from 250 to 600 Vdc (400V class).
- When the AC input voltage is lower than the 07-13 value ($07-13 / 1.414 = \text{AC voltage detection level}$) for the time specified in 07-25 the low-voltage error "UV" will displayed. If 07-25=0.00 sec., the UV error will be displayed immediately.

Set preventive measures :

- (1) The inverter input voltage will limit the output voltage. If the input voltage drops excessively, or if the load is too big, the motor may stall.
- (2) If the input voltage drops below the value set in 07-13 then the output is turned off momentarily. The inverter will not automatically start when power is restored.

07- 18	Minimum base block time
Range	【0.1~5.0】 Sec

- In case of a momentary power failure, the inverter continues to operate after the power has been restored when parameter 07-00 is set to 1.
- Once the momentary power failure is detected; the inverter will automatically shut down the output and maintain B.B for a set time (07-18).
- When the momentary power failure time exceeds the minimum base block time (07-18), the inverter will automatically perform a speed search upon return of power.

Refer to the following figure 4.3.63 ◦

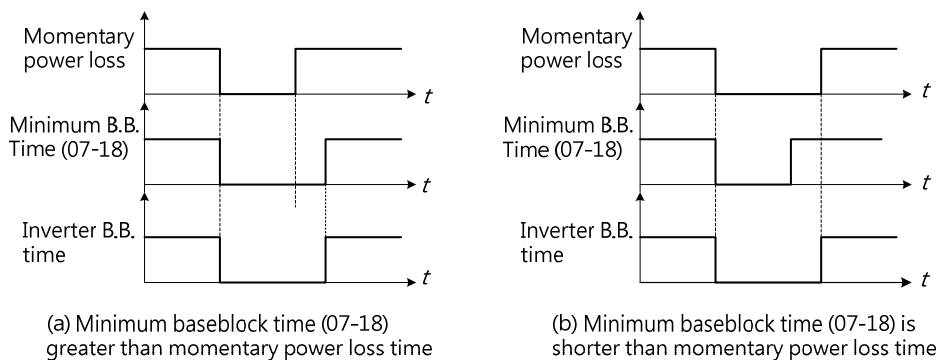

Figure 4.3.63 Minimum B.B time and momentary power loss time

- Minimum base block time (07-18) is also used to for the DC braking function
- Set the minimum base block time required (07-18).
- Increase minimum Baseblock time if over-current "OC" condition occurs.

07- 19	Speed Direction Search Operation Current
Range	【0~100】 %
07- 20	Speed Search Operating Current
Range	【0~100】 %
07- 21	Integral time of speed searching
Range	【0.1~10.0】 Sec
07- 22	Delay time of speed searching
Range	【0.0~20.0】 Sec
07-23	Voltage recovery time
Range	【0.1~5.0】 Sec
07- 24	Direction-Detection Speed Search Selection
Range	【0】 : Disable 【1】 : Enable
07- 33	Start Frequency of Speed Search Selection
Range	【0】 : Maximum Output Frequency of Motor 【1】 : Frequency Command

- Speed search function is used to find the speed of a coasting motor and continue operation from that point. The speed search function is active after a momentary power loss.

- Set the multi-function digital input to external speed search command 1 or 2. External speed search command 1 (value = 19) and 2 (value = 34) cannot be set at the same time, otherwise "SE02" (digital input terminal error) warning occurs.
- Speed search function must be enabled before applying the run command to ensure proper operation.

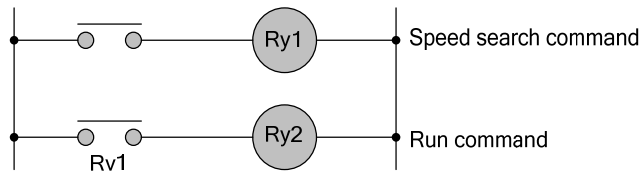

Figure 4.3.64 Speed search and operation commands

- The speed search cannot be used when the motor rated power is greater than the inverter rated power.
- In V / F mode, it is necessary to perform a static auto-tune.
- In SLV mode, it is necessary to perform a rotational auto-tune. Perform a static auto-tune when using long motor leads.

➤ **Speed Direction Search Operating Current (07-19)**

- (1) Used in bidirectional speed search only (07-24 = 1).
- (2) Set bidirectional current level.
- (3) Increase value if speed search is not successful at low speeds (above 5Hz)

Note :

If value is too high may cause DC braking effect.

➤ **Speed Search Operating Current (07-20)**

- (1) Can be used for bidirectional (07-24 = 1) or unidirectional (07-24 = 0) speed search.
- (2) Sets speed search current Level.
- (3) The set value must be lower than the excitation current (02-09) and must equal to the no-load current. If the no-load current is unknown it is recommended to set value at 20%.
- (4) Excessive speed search current will cause inverter output to saturate.
- (5) It is recommended to use speed search in case of a momentary power loss. Increase the minimum base block time (07-18) in case of an over-current condition.

➤ **Integral time of speed searching (07-21)**

- (1) Can be used for bidirectional (07-24 = 1) or unidirectional (07-24 = 0) speed search.
- (2) Set the integral time during speed search.
- (3) If OV occurs, increase the set value to increase the speed search time. Decrease the value if a quick start is required.

➤ **Delay time of speed searching (07-22)**

- (1) Use delay time (07-22) when using a contactor on the inverter output side.
- (2) Speed search delay time is disabled when set to 0.0 sec. (07-22 = 0.0)

➤ **Voltage recovery time (07-23).**

- (1) Sets the voltage recovery time.
- (2) Sets the time for the inverter to restore the output voltage from 0V to the specified V/f level after speed search function is completed.

➤ **Direction-Detection Speed Search (07-24) :**

- (1) 07-24=1, enable direction-detection speed search :

At start the current controller will send a step current to the motor (07-19) to determine the motor direction. Once direction is determined the current controller will perform a speed search using speed search operating current defined in parameter 07-20. Speed search is executed after a momentary power loss (external speed search command 2, 03-00 to 03-05=34) or from max. frequency (external speed search command 1, 03-00 to 03-05=19). Speed search direction will follow the speed command.

- (2) 07-24=0, disable direction-detection speed search :

Speed search is executed using speed search operating current defined in parameter 07-20. In case speed search is not successful (e.g. motor speed is too low) a speed search time-out warning is displayed. Set 07-19 to value greater than 0 to enable DC braking at speed search if a time-out occurs frequently.

➤ **Start-Up Mode Selection of SLV Coast to Stop (07-26)**

- (1) When 07-26=0 · speed search function is enabled. (default setting)
- (2) When 07-26=1 · normal start
- (3) In SLV mode (00-00=2) set the stop mode to the coast stop (07-09=1) or to the coast to stop with timer (07-09=3). After a stop command is issued (coast to stop or coast to stop with times) the speed search function is automatically activated for the next start.

➤ **Start Selection after Fault During SLV Mode (07-27)**

- (1) When 07-27=0 · speed search function is enabled. (default setting)
- (2) When 07-27=1 · normal start

Notes:

Set the parameter to 1 (normal start) after fault has occurred and mechanical brake is used to stop the motor.

➤ **Start after External BaseBlock (07-28)**

- (1) When 07-28=0 · speed search function is enabled. (default setting)
- (2) When 07-28=1 · normal start

Notes:

Set parameter to 1 for the control mode of V/F mode (00-00=0) or SLV mode (00-00=2) when the external base block active time is longer than the time the motor needs to come to a complete stop. After the external base block command is removed, the inverter will accelerate from minimum frequency.

➤ **Start Frequency of Speed Search Selection (07-33)**

- (1) When 07-33=0, the start speed search from the maximum output frequency of motor.
- (2) When 07-33=1, the inverter start speed search from setting frequency command.

(a) Speed search at starting

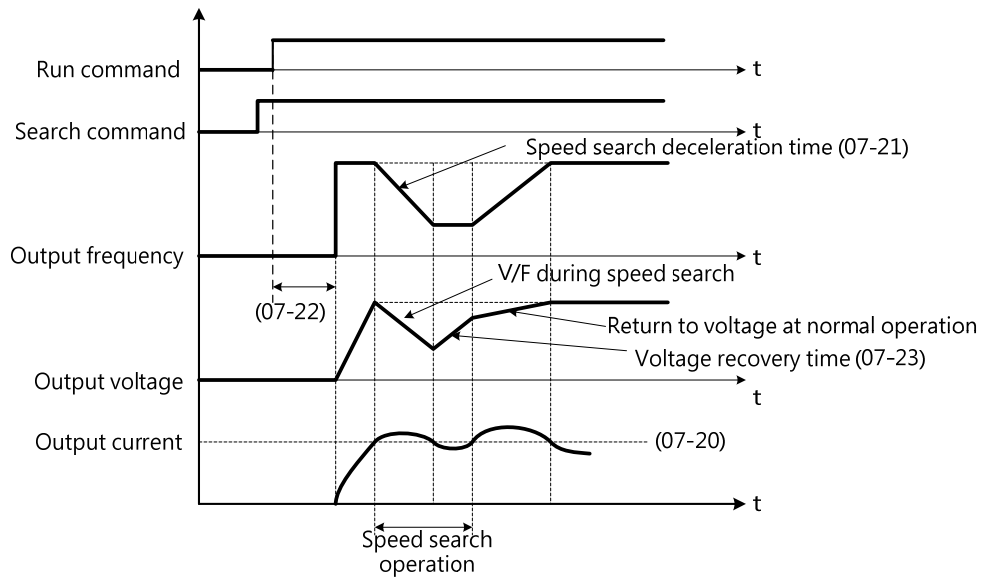

Figure 4.3.65 Speed search at starting

(b) Speed search in recovery period of momentary power failure

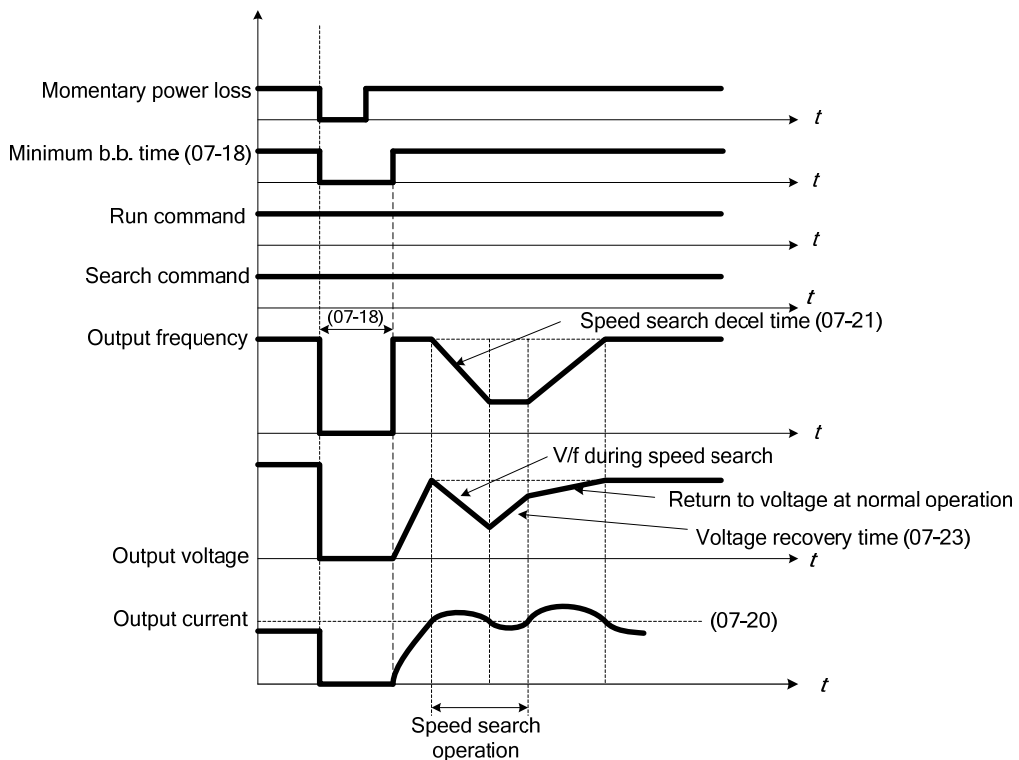

Figure 4.3.66 Speed search in recovery period of momentary power failure

Note :

- If the minimum base block time (07-18) is longer than the momentary power failure time, the speed search starts operation after the minimum base block time (07-18).
- If the minimum base block time (07-18) is too short, the speed search operation begins immediately after power has been restored.

07- 29	Run Command Selection at the Action of DC Braking
Range	【0】 : Not Allowed to Run 【1】 : Allowed to Run

- After DC braking action starts, if run command selection is set to 0, it will not run until DC braking action ends. If run command election is set to 1, it is not required to wait for the ending of DC braking action. It can run during DC braking action process.

07- 37	Pre-excitation time
Range	【0.00~10.00】 Sec

- If a high starting torque is required for the application, especially for a large horsepower motors, the pre-excitation operation can be used to pre-flux (magnetize) the motor.
 - (1) When an operation command (forward or reverse) is activated, the inverter will automatically start pre-excitation based on the time set in parameter 07-37.
 - (2) The time for the flux to reach 100% is a function value of motor's electrical time constant, see figure 4.3.62.
 - (3) Electrical time constant (quadratic by-pass circuit time constant) can be calculated by motor parameter setting (group 02).

$$\text{Electrical time constant } T2 = \frac{\text{Motor leakage inductance (02-17) + motor mutual inductance (02-18)}}{\text{Motor leakage resistance}}$$

- (4) Set the pre-excitation time (07-37) based on the electrical time constant T2

07- 38	Pre-excitation level
Range	【50~200】 %

- (1) Use the pre-excitation initial level (07-38) to provide a higher excitation current during the pre-excitation time (07-37), which will increase the speed and stability for motors.
- (2) In order to quickly magnetize the motor, reduce the pre-excitation time (07-37) and set the pre-excitation level (07-38) to a high level.
- (3) If 07-38 is set greater than 100%, providing a high excitation current during the pre-excitation time (07-37), motor's magnetization time is shorted. When the setting reaches 200%, magnetization is reduced by roughly half.
- (4) A high pre-excitation level (07-15) might result in excessive motor sound during pre-excitation.
- (5) When the flux reaches 100%, pre-excitation current reverts back to 100% and pre-excitation is completed, refer figure 4.3.62 °

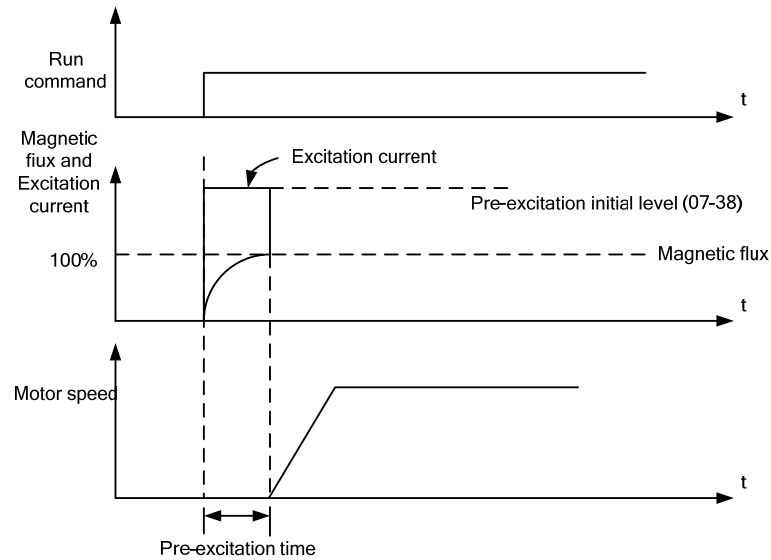

Figure 4.3.62 Pre-excitation operation

07- 39	Short-Circuit Braking Time of PM Motor Speed Search Function
Range	【0.00~100.00】 Sec
07- 40	DC injection Braking Time of PM Motor Speed Search Function
Range	【0.00~100.00】 Sec

- If the motor speed lower than inverter control speed, inverter can stop the motor by parameter 07-39 and 07-40 and restart. If the motor speed higher than inverter control speed, inverter will be started by actual speed, no matter the setting value of parameter 07-39 and 07-40.

07- 45	STP2 Function Selection
Range	【0】 : STP2 is enabled 【1】 : STP2 is disabled

- If STP2 is enabled, when 00-02=1 and external operation signal is tripped, keypad will display “Terminal STOP” error when stop command comes from keypad.
- If STP2 is disabled, when 00-02=1 and external operation signal is tripped, keypad will not display “Terminal STOP” error when stop command comes from keypad.

Group 08 Protection Parameters

08- 00	Stall prevention function
Range	<p>【xxx0b】 : Stall prevention function is enabled during acceleration. 【xxx1b】 : Stall prevention function is disabled during acceleration. 【xx0xb】 : Stall prevention function is enabled during deceleration. 【xx1xb】 : Stall prevention function is disabled during deceleration. 【x0xxb】 : Stall prevention function is enabled during operation. 【x1xxb】 : Stall prevention function is disabled during run. 【0xxxb】 : Stall prevention function during run is based on the first deceleration time. 【1xxxb】 : Stall prevention function during run is based on the second deceleration time.</p>
08- 01	Stall prevention level during acceleration
Range	【20~200】 %
08- 02	Stall prevention level during deceleration
Range	200V : 【330V~410V】 400V : 【660V~820V】
08- 03	Stall prevention level during run
Range	【30~200】 %
08-21	Limit of stall prevention during acceleration
Range	【1~100】 %
08-22	Stall prevention detection time during run
Range	【2~100】 mSec
08- 40	Motor 2 Acceleration Stall Prevention Level
Range	【20~200】 %
08-41	Motor 2 Acceleration Stall Prevention Limit
Range	【1~100】 %

Note : Stall prevention function only can be set in V/F control mode.

➤ **Stall prevention during acceleration (08-00=xxx0b)**

- (1) Prevents the inverter from faulting (Overcurrent, Motor overload, Inverter overload) when accelerating with heavy loads.
- (2) When the inverter output current reaches the level set in parameter 08-01 minus 15% the acceleration rate starts to decrease. When the inverter output current reaches the level set in parameter 08-01 the motor stops accelerating.
- (3) Reduce stall prevention level during acceleration (08-01) in case the motor stalls (when the motor power is smaller than the inverter rating).

Please refer fig.4.3.67 for stall prevention during acceleration.

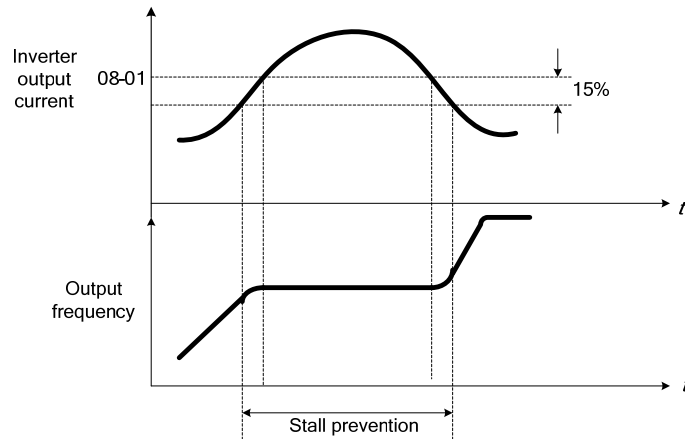

Figure 4.3.67 Stall prevention during acceleration

- (4) If the motor is used in the constant power (CH) region, the stall prevention level (08-01) is automatically reduced to prevent the stall.
- (5) Stall prevention level during acceleration (Constant horsepower)

$$\text{Stall Prev. Lev. Acceleration (CH)} = \frac{\text{Stall prevention level in acceleration (08-01)} \times \text{Fbase (01-12)}}{\text{Output frequency}}$$

- (6) Parameter 08-21 is the stall prevention limit value in Constant Horsepower region.

Please refer figure 4.3.68

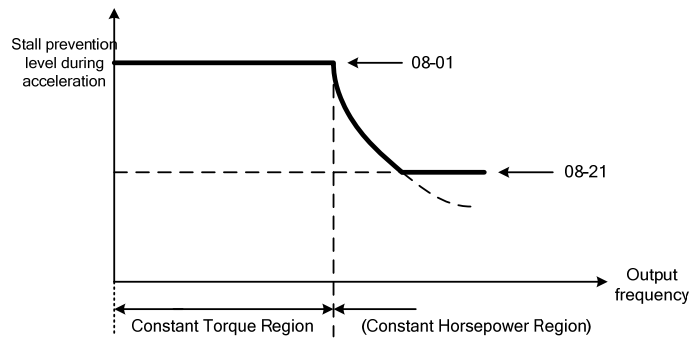

Figure 4.3.68 Stall prevention level and limit in acceleration

- (7) Motor2 Acceleration Stall Prevention Level (08-40) and Motor2 Acceleration Stall Prevention Limit (08-41) are Used when 03-00~03-07=40 (Switching between Motor 1/Motor 2)

➤ **Stall prevention selection during deceleration (08-00=xx0xb)**

- (1) Stall prevention during deceleration automatically increases the deceleration time according based on the DC-bus voltage to prevent over-voltage during deceleration.
- (2) When the DC-bus voltage exceeds the stall prevention level deceleration will stop and the inverter will wait for the DC-bus voltage to fall below the stall prevention level before continuing deceleration

Stall prevention level can be set by 08-02, see table 4.3.34 ◦

Table 4.3.34 Stall prevention level

Inverter model	08-02 default value
200V class	385VDC
400V class	770VDC

Please refer fig.4.3.69 for stall prevention during deceleration.

- When external braking function is starting (braking resistor or braking module), stall prevention during deceleration function (08-00 to xx1xb) is disabled.

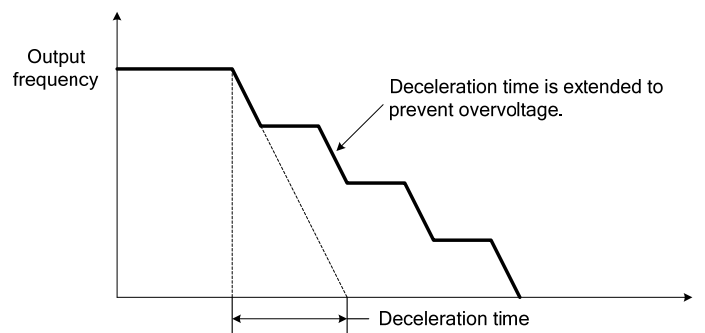

Figure 4.3.69 Stall prevention selection in deceleration

➤ **Stall prevention selection during run (08-00=x0xxb)**

- (1) This function prevents the motor from stalling by automatically reducing the output frequency during run.
- (2) If the inverter output current rises above the level set in parameter 08-03 for the time specified in parameter 08-22, the inverter output frequency is automatically decreased following deceleration time 1 (00-15) or deceleration time 2 (00-17).
- (3) When the inverter output current falls below the level set in parameter (08-03) minus 2%, normal operation continues and the output frequency increases to the frequency reference using the acceleration time 1 or acceleration time 2. Refer to the following figure 4.3.70.

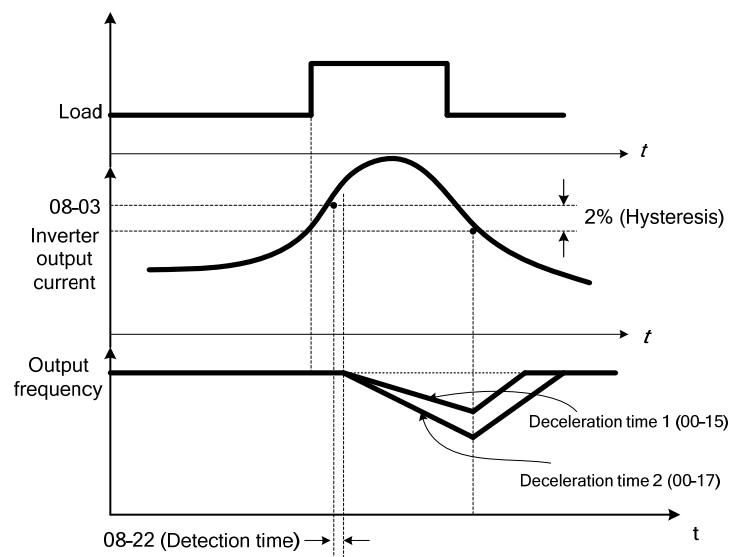
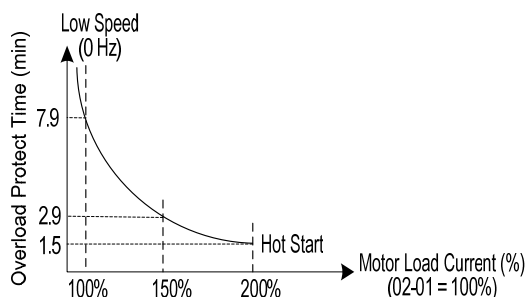

Figure 4.3.70 Stall prevention selection during operation

08- 05	Selection for motor overload protection (OL1)
Range	<p>【xxx0b】 : Motor overload is disabled</p> <p>【xxx1b】 : Motor overload is enabled</p> <p>【xx0xb】 : Cold start of motor overload</p> <p>【xx1xb】 : Hot start of motor overload</p> <p>【x0xxb】 : Standard motor</p> <p>【x1xxb】 : Special motor</p> <p>【0xxxb】 : Reserved</p> <p>【1xxxb】 : Reserved</p>

- (1) Please set motor overload protection function by parameter 08-05 according to currently motor.
- (2) Turn off the motor overload protection when using two or more motors connected to the inverter (set 08-05=xxx0b), and provide external overload protection for each motor
- (3) With hot start enabled (08-05=xx1xb), motor overload protection occurs in 3 and a half minutes when operating the motor at 150% of the motor rated current at an output frequency greater than 60Hz.
- (4) When 08-05=x0xxb, overload protection function is based on 70% of the motor rated current for an output frequency of 20Hz. If the output frequency is lower than 1Hz, the overload protection function uses 40% of the motor rated current to determine an overload condition.
- (5) When 08-05=x1xxb, overload protection function is based on motor rated current for output frequencies between 6 and 60Hz. If the output frequency is lower than 1Hz, the overload protection function uses 83% of the motor rated current to determine an overload condition.
- (6) To use the built-in motor overload protection function parameter 02-01 (motor rated current) has to match the motor rated current on the motor nameplate.

Hot Start curve :



(Low speed curve)

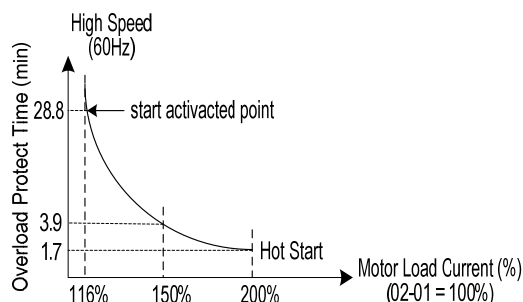

(High Speed curve)

Cold Start Curve :

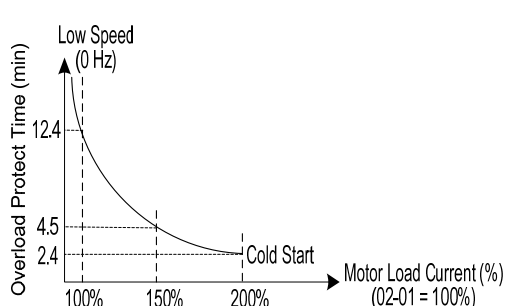

(Low speed curve)

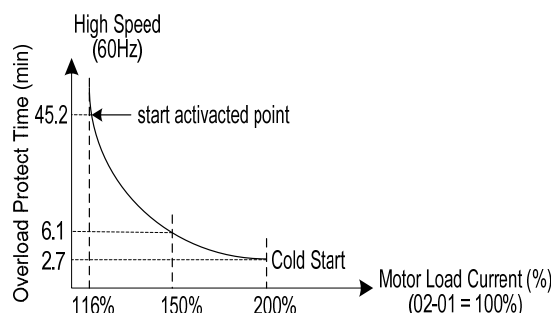

(High Speed curve)

08- 06	Start-up mode of overload protection operation (OL1)
Range	【0】 : Stop output after overload protection 【1】 : Continuous operation after overload protection.

- **08-06=0** : When the inverter detects a motor overload the inverter output is turned off and the OL1 fault message will flash on the keypad. Press RESET button on the keypad or activate the reset function through the multi-function inputs to reset the OL1 fault.
- **08-06=1** : When the inverter detects a motor overload the inverter will continue running and the OL1 alarm message will flash on the keypad until the motor current falls within the normal operating range.

08- 07	Over heat protection (Cooling fan control)
Range	【0】 : Auto (Depends on temperature) 【1】 : Operate while in Run Mode 【2】 : Always Run 【3】 : Stop Operation
08 - 38	Delay Time of Fan Off
Range	【0 ~ 600】 Seconds

- **Over heat protection (Cooling fan control) (08-07)**
 - (1) When 08-07=0, the inverter start to run, when **IGBT** temperature is higher than setting level, the fan start to run. If the temperature drops period higher than 08-38, the fan stop.
 - (2) When 08-07=1, The inverter is supplied by power, the fan start to run. If inverter stop to run longer than 08-30, the fan start to stop.
 - (3) When 08-07=2, The inverter is supplied by power, the fan start to run.
 - (4) When 08-07=3, The fan will not run.

Models	Fan start to run	Fan start to stop
2P5-210, 401-415	IGBT $\geq 90^{\circ}\text{C}$	IGBT $< 70^{\circ}\text{C}$
215-240, 420-475	IGBT $\geq 95^{\circ}\text{C}$	IGBT $< 75^{\circ}\text{C}$

Note :

When 08-07=0, if inverter stop, but the heatsink temperature is still too high, the cooling fan will start to run.

08- 08	Automatic voltage regulation (AVR)
Range	【0】 : AVR is enabled 【1】 : AVR is disabled

- Automatic voltage regulation stabilizes the motor voltage independent of fluctuation to the input voltage.
 - (1) When 08-08=0, automatic voltage regulation is active. It will limit the maximum output voltage. When input three-phase voltage fluctuates and the voltage is smaller than the value of 01-14, the output voltage will fluctuate with the fluctuation of input voltage.
 - (2) When 08-08=1, automatic voltage regulation is not active, motor voltage follows the input voltage fluctuation. When input three-phase voltage fluctuates, the output voltage won't fluctuate with the fluctuation of input voltage.

08- 09	Selection of input phase loss protection
Range	【0】 : Disable 【1】 : Enable

- (1) When 08-09=0 : Input phase loss detection is disabled.
When 08-09=1 : Input phase loss detection is enabled.
- (2) Keypad shows "IPL input Phase Loss" (IPL), when an input phase loss is detected the inverter output is turned off and the fault contact is activated.
- (3) The input phase loss detection is disabled when the output current is less than 30% of the inverter rated current.

08- 10	Selection of output phase loss protection
Range	【0】 : Disable 【1】 : Enable

- (1) When 08-10=0 : Output phase loss detection is disabled.
When 08-10=1 : Output phase loss detection is enabled.
- (2) Keypad shows "OPL Output Phase Loss" (OPL), when an output phase loss is detected and the inverter output is turned off and the fault contact is activated.
- (3) The output phase loss detection is disabled when the output current is less than 10% of the inverter rated current.

08- 13	Selection of over-torque detection
Range	【0】 : Over-torque detection is disabled 【1】 : Start to detect when reaching the set frequency 【2】 : Start to detect when the operation is begun
08- 14	Selection of over-torque action
Range	【0】 : Deceleration to stop when over-torque is detected. 【1】 : Displays warning when over-torque is detected. Continue operation. 【2】 : Coast to stop when over-torque is detected
08- 15	Level of over-torque detection
Range	【0~300】 %
08- 16	Time of over-torque detection
Range	【0.0~10.0】 Sec

- The over torque detection function monitor the inverter output current or motor torque and can be used to detect increase in inverter current or motor torque. load).
- The low torque detection function monitor the inverter output current or motor torque and can be used to detect a decrease in inverter current or motor torque
- The torque detection levels (08-15, 08-19) are based on the inverter rated output current.
 - (1) In V/F control mode, based on 100% rated output current of inverter.
 - (2) In SLV mode, based on 100% rated torque of inverter.
- Over and low torque detection condition can be output to the multi-function digital outputs (R1A-R1C, R2A-R2C) by setting parameters 03-11 to 03-12 to 12. Refer to figure 4.3.72

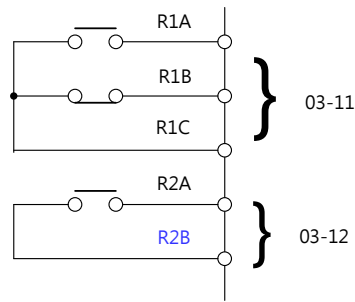

Figure 4.3.72 Over/Low torque detection for DI/DO terminals

➤ Example for over torque detection :

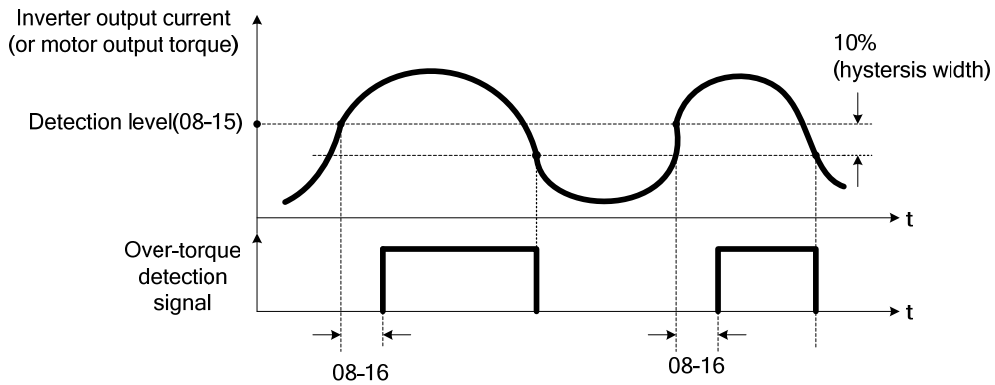

Figure 4.3.73 for Over-torque detection operation

08- 23	Ground Fault (GF) selection
Range	【0】 : Disable 【1】 : Enable

- When 08-23=0 : Ground fault function is disable
When 08-23=1 : Ground fault function is enable
- If the inverter leakage current is greater than 50% of inverter rated current and the ground fault function is enabled (08-23), the keypad will display a "GF Ground Fault" (GF), motor will coast to a stop and fault contact is activated.

08- 24	Operation Selection of External Fault
Range	【0】 : Deceleration to Stop 【1】 : Coast to Stop 【2】 : Continous Operation

- When multi-function digital input terminal is set to 25 (the external fault) and this terminal signal is triggered off, parameter 08-24 (Operation Selection of External Fault) can be selected to stop it. The selection of stop modes is the same as 07-09.

08- 25	Detection Selection of External Fault
Range	【0】 : Immediately Detect when the Power is Supplied 【1】 : Start to Detect During Operation

- The reason for the detection of external faults is determined by parameter 08-25.
 - (1) When 08-25=0, faults are immediately detected at power up.
 - (2) When 08-25=1, faults are detected when the inverter is running.

08 - 35	Motor Overheat Fault Selection
Range	【0】 : Disable 【1】 : Coast to Stop 【2】 : Free run to top 【3】 : Keep running
08 - 36	PTC Input Filter Time Constant
Range	【0.00 ~ 5.00】
08 - 39	Delay Time of Motor Overheat Protection
Range	【1 ~ 300】 Sec
08 - 42	PTC Protection Level
Range	【0.1 ~ 10.0】 V
08 - 43	PTC Restart Level
Range	【0.1 ~ 10.0】 V
08 - 44	PTC Warning Level
Range	【0.1 ~ 10.0】 V

Motor Overheat Fault Selection :

- It executes motor overheat protection by the resistor (PTC) that built-in the motor.
 - The resistor (PTC) is between AI2 and GND and a divided resistor R ,as the pic 4.3.65(b)
- (1) When motor occurs overheating :
 - 08-35 = 0 : Motor overheats fault function is off.
 - 08-35 = 1 : When the motor is overheating, it coasts to stop.
 - 08-35 = 2 : When the motor is overheating, it free runs to stop
 - 08-35 = 3 : When the motor is overheating, it keeps running until reach the value of 08-42
 - (2) 08-35=1 or 2, if the temperature is getting higher for the motor and AI2 voltage level is higher than the value of 08-44, the display will show 『OH4 Motor Overheating』 and the motor will stop by 08-35=1 or 2.
 - (3) 08-35=3, When the temperature is getting higher for the motor and AI2 voltage level is higher than the value of 08-44, the display will show 『OH3 Motor Temp Warning』 but the motor continues running. But AI2 voltage level is higher than the value of 08-42 and the time reach to 08-39, the motor free runs to stop.
 - (4) When 08-35 = 1 or 2 or 3 · When the motor cools down and AI2 voltage level is lower the value of 08-43, 『OH4 Motor overheat』 will reset.
 - (5) The resistor (PTC) conform the British Standards Institution :
 - When Tr is 150 °C in Class F and is 180°C in Class H
 - Tr-5°C : $R_T \leq 550\Omega$ · put R_T in formula (1), the V value by calculation is the value of 08-43.
 - Tr+5°C : $R_T \geq 1330\Omega$ · put R_T in formula (1), the V value by calculation is the value of 08-44.
 - (6) It gets reference value by using formula (1) even in the different spec of resistor (PTC).

$$V = \frac{1}{2} \times 10 \times \frac{(R_{PTC} // 200)}{R + (R_{PTC} // 200)} \quad (1)$$
 - (7) Please follow the rule of PTC protection function setting, prevent the error occurs.
PTC restart level(08-43) > PTC warning level(08-44) > PTCprotection level(08-42)

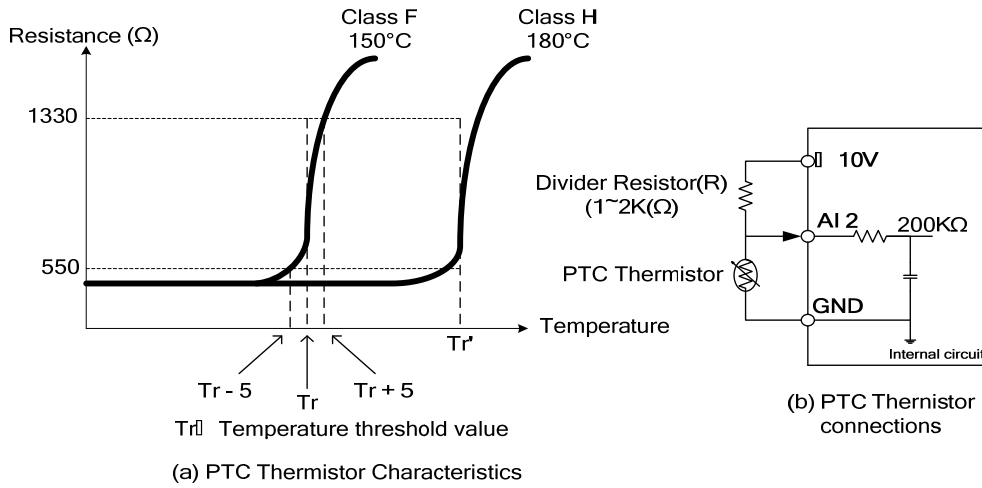

Figure 4.3.65 (a) PTC Thermistor Characteristics (b) PTC Thermistor Connections

Notes:

For PTC thermistor connections, JP3 switch needs to set V, 04-00 needs to set 0 or 2.

08 - 46	Temperature Agree Level
Range	【0 ~ 254】 °C
08 - 47	Temperature Reset Level
Range	【0 ~ 254】 °C

Selection of temperature agree level and temperature reset level

- When 03-11=59 :
- 08-46 : When temperature of inverter is higher than 08-46, output relay will active.
- 08-47 : When temperature of inverter is less than 08-47, output signal of relay will turn to off.

Diagram :

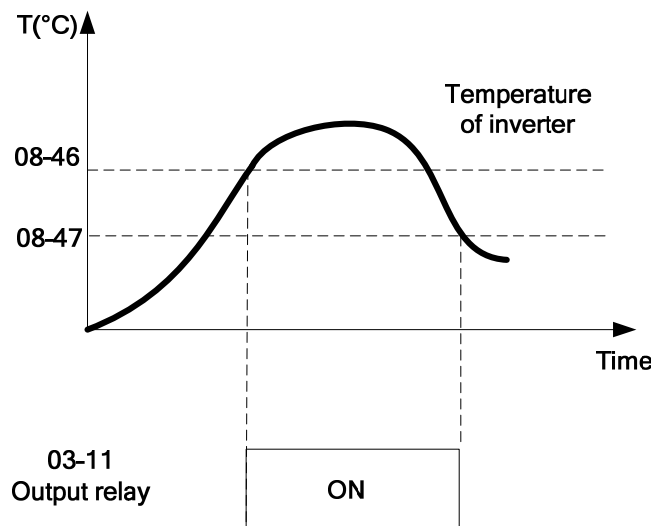

Figure 4.3.66 Inverter temperature agree and reset detection

08 - 48	Selection of Fire Mode
Range	【0】 : Disable 【1】 : Enable

- When 08-48=0, Fire Mode is disabled.
When 08-48=1, Fire Mode is enabled.
- When fire mode is enabled, S6 will be defined to signal input of fire mode
(Parameter 03-05 will be set to 47 automatically).

When fire mode is enabled, inverter will become to fire mode. No matter inverter is running or stopping, run and frequency command source will be covered by the setting of fire mode, keypad display will show “ FIRE ”, some of protect functions will be ignored, please refer the table 4.3.35, inverter will not stop.

When fire mode (03-0X=47) and outour overload (03-0X=68) function is triggered, the other digital inputs will be ignored, the parameters just can be read by communication or keypad display.

08 - 49	Multi-Function Input Terminal Status of Fire Mode
Range	【0】 : Reset after Power Off 【1】 : Reset after Terminal Removed

- When 08-49=0, pelase disconnect the power first, remove external trigger signal and then connect the power.
- When 08-49=1, no need to disconnect the power, inverter will become to normal mode, run and frequency will reture to original setting.

Notes: Fire Mode function does not support PUMP function.

0x2521H	Fault Description
4	OH1 (Heat sink over heat)
5	OL1 (Motor overload)
6	OL2 (Inverter overload)
7	OT (Over torque)
25	FB (PID feedback signal error)
26	Keypad Removed
28	CE (Communication error)
46	OH4 (Motor over heat)
49	MtrSw (DI Motor Switch Fault)
58	PF(Protection error)

Table 4.3.35 These functions will be ignoed when fire mode is triggered

! Danger :

Fire mode:

The drive will run at full speed either in forward or reverse direction and ignore all software protections until any one of the hardware protection is triggered or drive is damaged to achieve the requirement of smoke extraction and reduce the hazard to humans.

08 - 50	Multi-Function Terminal Status of Fire Mode
Range	【xxx0b】 : S6 A Contact 【xxx1b】 : S6 B Contact

- Each bit of 08-50 presents an input :
- 08-50= 0 0 0 0 0 : Normal open
 s6 1 : Normal close

Notes:

Please set 08-40=0 (fire mode disabled) before setting normal open or normal close contact.
Failure to comply may cause death or serious injury.

08 - 51	Motor Speed Setting Source of Fire Mode
Range	【0】 : Fire Mode Speed (08-52) 【1】 : PID Control 【2】 : AI2

- When 08-51=0, motor speed setting will follow 08-52. If the value of 08-52 is 100%, inverter output frequency will follow the value of 01-02.
- When 08-51=1, motor speed setting will follow PID control; when fire mode is enabled, PID control will base on 10-47/10-48/10-49 (please refer the setting value of group 10)
- When 08-51=2, frequency reference will become to 4-20mA (default setting of 04-00)

08 - 53	PID Detection Level of Fire Mode
Range	【0~100】 %

- When 08-51=1, PID feedback loss detection function will be opened automatically.

08 - 54	Delay Time of Fire Mode PID Loss
Range	【0.0~10.0】 Sec

- When fire mode is enabled, if 08-51=1 and then PID feedback, inverter will be stopped after the setting value of 08-54.

08 - 55	PID Feedback Loss Detection Selection of Fire Mode
Range	【0】 : Keep Running 【1】 : Fire Mode Speed(08-52) 【2】 : Max. Output Frequency of Motor 1 (01-02)

- When 08-51=0, output frequency will be fixed on current frequency.
- When 08-51=1, output frequency will be based on the setting value of parameter 08-52.
- When 08-51=2, output frequency will be based on the setting value of parameter 01-02.

When PID feedback value less than 08-53 and then longer than 08-54, inverter will keep running, but the frequency reference will be switched to 08-55, output frequency will not less than the setting value of 08-52.

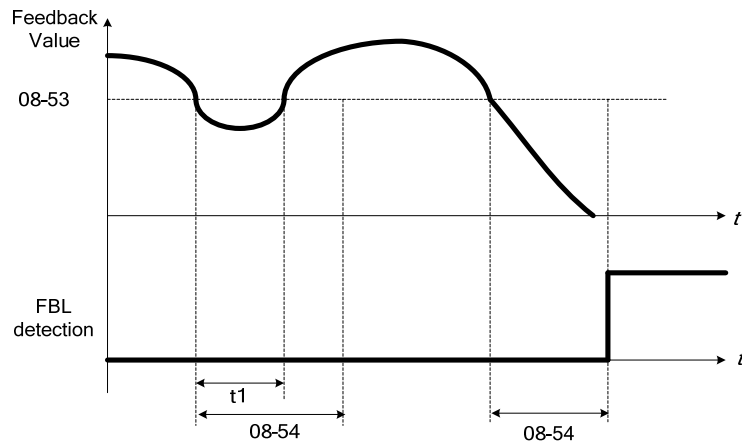

Fig 4.3.75 PID feedback loss detection

Notes:

If there is no any feedback signal and then feedback loss level also be set to 0%, feedback loss detection function will not be triggered.

08 - 56	Detection Level of Fire Mode AI2 Signal
Range	【0~100】 %
08 - 57	Delay Time of Fire Mode AI2 Signal Loss
Range	【0.0~10.0】 Sec
08 - 58	Selection of Fire Mode AI2 Signal Loss
Range	【0】 : Keep Running 【1】 : Fire Mode Speed(08-52) 【2】 : Max. Output Frequency of Motor 1 (01-02)

- When 08-51=2 (AI2), inverter will trigger AI2 feedback loss detection function automatically.
- Selection of Fire Mode AI2 Signal Loss (08-58) :
 - (1) When 08-58=0, output frequency will be fixed on current frequency.
 - (2) When 08-58=1, output frequency will be based on the setting value of parameter 08-52.
 - (3) When 08-58=2, output frequency will be based on the setting value of parameter 01-02.
- If AI2 signal is less than the setting value of 08-56 in 360ms, and the time longer than setting value of 08-57, the frequency reference will be considered to loss.
- Analog signal will compare with the previous value at 360ms, if inverter ensure the frequency reference already loss, frequency reference will base on the value of 08-58.

Following is the description of the Frequency Loss Function:

When the inverter is in operation and the selected analog command source AI2 disappears, the command will operate according to the setting ratio of 08-58.

The following figure (fig 4.3.76) is the operating diagram of analog frequency instruction AI2 when the frequency instruction is lost.

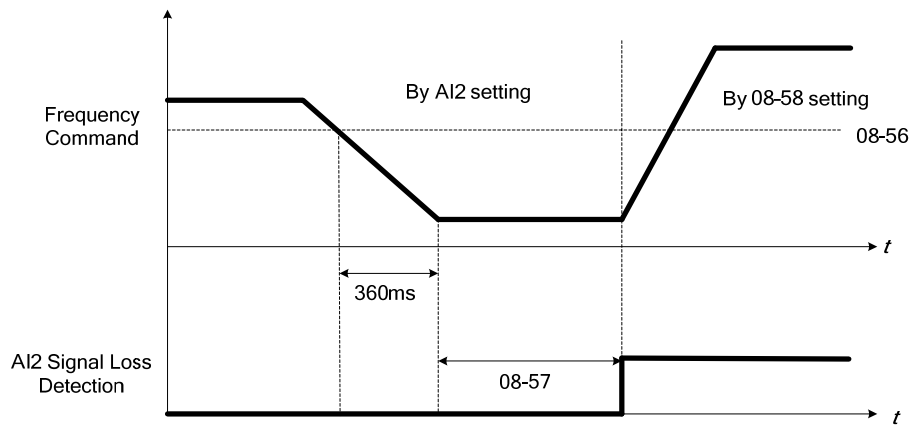

Fig 4.3.76 AI2 frequency reference loss

08 - 59	Fire Mode Motor Direction
Range	【0】 : Forward 【1】 : Reverse

- When fire mode is enabled, motor direction will base on the setting of 08-59, the priority of 08-59 is higher than keypad and digital input.

08 - 60	Fire Mode Password
Range	【00000 ~ 65534】

- When fire mode is enabled, use can set password in parameter 08-60, please refer the process of parameter 13-07.
- In order to prevent the parameters of fire mode being modified, keypad display will just show the related parameters of fire mode when fire mode is enabled. (Parameter 08-48~08-60 will be read only).
- Parameter 08-60(password of fire mode) and 13-07(parameter password), only one parameter can be allowed to set at the same time.

Group 09 Communication Parameters

09- 00	INV Communication Station Address
Range	【1~254】
09- 01	Communication Mode Selection
Range	【0】 : MODBUS 【1】 : BACNet 【3】 : PUMP parallel communication
09- 02	Baud Rate Setting (bps)
Range	【2】 : 4800 【3】 : 9600 【4】 : 19200 【5】 : 38400
09- 03	Stop Bit Selection
Range	【0】 : 1 stop bit 【1】 : 2 stop bits
09- 04	Parity Selection
Range	【0】 : No Parity 【1】 : Even bit 【2】 : Odd bit
09- 05	Communication Data Bit Selection
Range	【0】 : 8 Bit Data 【1】 : 7 Bit Data
09- 06	Communication Error Detection Time
Range	【0.0~25.5】 Sec
09- 07	Fault Stop Selection
Range	【0】 : Deceleration to stop based on deceleration time 1 【1】 : Coast to stop when communication fault occurs 【2】 : Deceleration to stop based on deceleration time 2 【3】 : Keep operating when communication fault occurs
09- 08	Comm. Fault Tolerance Count
Range	【1~20】
09- 09	Waiting Time
Range	【5~65】 mSec
09- 10	BACNET Device Instance Number
Range	1~254

- The Modbus communication port RJ45 and TM2 terminal (S+, S-) can be used to monitor, control, program and trouble-shoot the inverter.
- Modbus communication can perform the following operations, independent of the frequency command selection (00-05) setting and Operation command selection (00-02) setting.
 - (1) Monitoring the status from controller.
 - (2) Please do not write and read the parameters by communication very often because the EEPROM component will be damaged.
 - (3) Control multi-function inputs.

Note :

When 09-01=0 (MODBUS), it can identify the communication format for ASCII and RTU. If the controller uses RTU format, it can not support communication data bit of 7 bit data. (09-05=1).

Modbus (RS-485) communication specification :

Items	Specifications
Interface	RS-485
Communication period	Asynchronous (start - stop synchronization).
Communication parameters	Baud rate : 4800, 9600, 19200 and 38400 bps. Data Length : 8 bits (Fixed). Parity : options of none, even and odd bit. For even and odd selection stop bit is fixed at 1 bit.
Communication protocol	Modbus (included RTU mode and ASCII mode).
Number of inverters	Maximum 31 units.

Please refer the detail instruction to “Appendix 3-Modbus”.

➤ **Commnuication wiring and setup**

- (1) Turn off power supply and connect communication lines of the controller to the inverter (RJ45).
- (2) Turn power on.
- (3) Set the required communication parameters (09-00) via the keypad.
- (4) Turn off power to the inverter and wait until keypad is completely off.
- (5) Turn power on again.
- (6) Start communication between controller and inverter.

➤ **Modbus (485) communication architecture**

- (1) Modbus communication configuration uses a master controller (PC, PLC), communicating to a maximum of 31 inverters.
- (2) The master controller is directly connected to the inverter via the RS-485 interface. If the master controller has a RS-232, a converter must be installed to convert signals to RS-485 to connect the master controller to the inverter.

A maximum 31 inverters can be connected to a network, following the Modbus communication standard. Communication parameters as follows :

➤ **Inverter station addresses (09-00)**

Setting range is 1-31.

➤ **RS-485 Communication baud rate setting (09-02)**

- 09-02= 2 : 4800 bps (bit/second)
- 09-02= 3 : 9600 bps
- 09-02= 4 : 19200 bps
- 09-02= 5 : 38400 bps

➤ **Stop bit selection (09-03, 09-04)**

09-03= 0 : 1 stop bit

09-03= 1 : 2 stop bits

09-04= 0 : No parity.

09-04= 1 : even parity

09-04= 2 : odd parity.

➤ **Communication Data Bit Selection (09-05)**

09-05= 0 : 8 bits data

09-06= 1 : 7 bits data

➤ **RS-485 communication error detection time(09-06)**

➤ **Stop selection of RS-485 communication failure (09-07)**

09-07= 0 : Deceleration to stop by deceleration time (00-15)

09-07= 1 : Coast to stop

09-07= 2 : Deceleration to stop using the deceleration time of 00-26 (emergency stop time)

09-07= 3 : Keep running(warning message only, press the stop button to stop operation)

➤ **Communication fault tolerance count (09-08)**

When the number of communication errors exceeds the value set in parameter 09-08 the inverter will display the communication fault alarm.

➤ **Wait time of inverter transmission (09-09)**

Sets the inverter response delay time. This is the time between the controller message and the start of the inverter response message. Refer to figure 4.3.76. Set the controller receive time-out to a greater value than the wait time parameter (09-09).

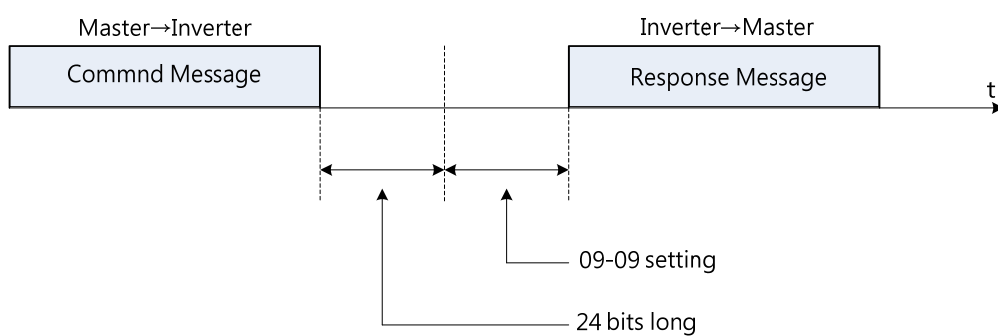

Figure 4.3.76 Communication message timing

Group 10 PID Parameters

10- 00	PID target value source setting
Range	【0】 : Keypad given 【1】 : AI1 given 【2】 : AI2 given 【3】 : Communication given 【4】 : Use 10-02 setting

➤ **When 10-00=0**

Keypad can adjust the PID target value.

➤ **When 10-00=1 or 2**

The source of signal is proportional to be corresponding to PID target via analog input terminal.

For example :

0~10V is corresponding to 0~100% target value, when being given 2V, 20% is obtained.

➤ **When 10-00=3,**

PID target value is communication input.

00-05=5, 10-03=0001, communication address 0X2502H (communication frequency).

➤ **When 10-00=4,**

(1) For general purpose of PID setting, set 10-00=4 to set the PID target value by 10-02.

(2) 10-02(PID target value) is set at percentage and PID setting is at main screen monitor (12-38).

(3) Maximum target value is set by parameter 10-33 (PID feedback maximum value), the decimals is determined by parameter 10-34 (PID decimal width), and the unit is set by parameter 10-35 (PID unit).

Example :

Set 10-33=999, 10-34=1, 10-35=3, and set 10-02 to 10%. Then 9.9PSI is displayed at the main screen monitor (12-38) and can be modified at this monitor. Maximum value is 99.9 PSI (limited to the setting value of parameter 10-33).

10- 01	PID feedback value source setting
Range	【0】 : Keypad given 【1】 : AI1 given 【2】 : AI2 given 【3】 : Communication given

Note : Parameter 10-00 and 10-01 cannot be set to the same source. If both parameters are set to the same source the keypad will show a SE05 alarm.

10- 02	PID target value
Range	【0.00~100.00】 %
10- 03	PID control mode
Range	【xxx0b】 : PID disable 【xxx1b】 : PID enable 【xx0xb】 : PID positive characteristic 【xx1xb】 : PID negative characteristic 【x0xxb】 : PID error value of D control 【x1xxb】 : PID feedback value of D control 【0xxxb】 : PID output 【1xxxb】 : PID output + Frequency Command

➤ **PID target value source setting (10-00)/PID feedback value source setting(10-01).**

Please confirm parameter 04-00 conform the need (0~10V or 4~20mA), if AI2 as PID target or PID feedback. And switch SW2 from control board to the input type (V or I), please refer to wiring diagram for more detail.

➤ **PID control mode (10-03)**

(1) **When 10-03= xxx1b : PID is enabled,**

LCD keypad will be switched automatically (16-00) and main screen monitoring displays PID target value (12-38). Sub-screen monitoring 1 (16-01) displays PID feedback value (12-39) and sub-screen monitoring 2 (16-02) displays frequency output (12-17). If PID is disabled, the keypad will switch automatically to frequency command setting as the main page.

(2) **When 10-03= xx1xb : PID output is reverse.**

PID output is chosen to reverse, and if PID input is negative, the output frequency of PID will gain. On the contrary, PID output is chosen to forward, and if PID input is negative, the output frequency of PID will decrease.

(3) **When 10-03= 0xxxb : PID output corresponds 100% to the frequency of 01-02.**

When 10-03=1xxxb, PID output + frequency command, it will cumulate the output percentage of frequency command, (corresponding to 01-02 main frequency main frequency command set by parameter 00-05/ 00-06) at the beginning of running and then start PID control.

10- 04	Feedback gain
Range	【0.01~10.00】
10- 05	Proportional gain (P)
Range	【0.00~10.00】
10- 06	Integral time (I)
Range	【0.0~100.0】 Sec
10- 07	Differential time (D)
Range	【0.00~10.00】 Sec
10- 08	Primary Delay Filter Time
Range	【1~250】 ms
10- 09	PID bias
Range	【-100~100】 %

10-14	PID integral limit
Range	【0.0~100.0】 %
10-23	PID limit
Range	【0.00~100.0】 %
10-24	PID output gain
Range	【0.0~25.0】
10-25	PID reversal output selection
Range	【0】 : Do not allow the reversal output 【1】 : Allow the reversal output
10-26	PID target acceleration / deceleration time
Range	【0.0~25.5】 Sec

➤ **PID Adjustments**

P control :

The error signal (deviation) between the input command (set value) and the actual control value (feedback). This error signal or deviation is amplified by the proportional gain (P) to control the offset between the set value and the feedback value.

I control :

The output of this control is the integral of the error signal (difference between set value and feedback value) and is used to minimize the offset signal that is left over from the gain control. When the integral time (I) is increased, the system response becomes slower

D control :

This control is the inverse from integral control and tries to guess the behavior of the error signal by multiplying the error with the differential time. The result is added to the PID input. Differential control slows down the PID controller response and may reduce system oscillation.

Note :

Most applications that PID control (fan and pump) do not require differential control.

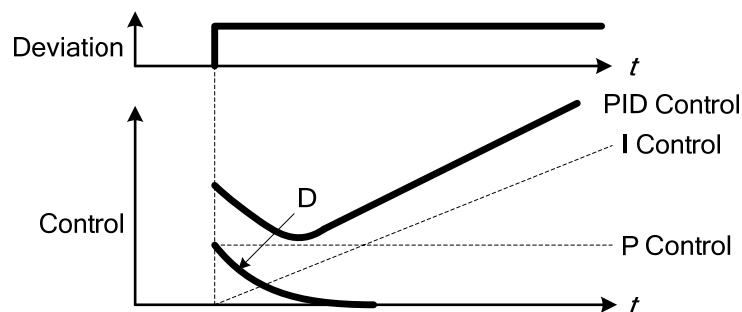

Figure 4.3.77 PID Control

➤ **PID Control Type, the inverter offers two type of PID control.**

(1) **PID control with differential feedback (10-03=x1xxb)**

Make sure to adjust the PID parameters without causing system instability. Refer to 4.3.78 for PID control for feedback value differential.

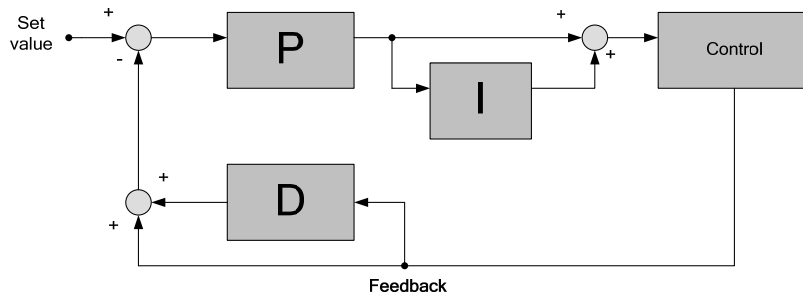

Figure 4.3.78 PID control for feedback differential value

(2) Basic PID control(10-03=x0xxb)

This is the basic type of PID control. Refer to the figure 4.3.79.

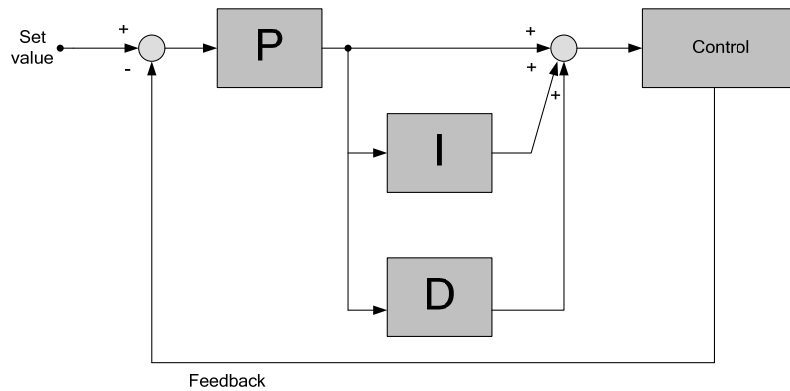

Figure 4.3.79 Basic PID control

➤ **PID Setup:**

Enable PID control by parameter 10-03, PID target value (10-00) and PID feedback value (10-01).

(1) Select PID target value : PID target value selection(10-00)

- 10-00=0 : Keypad given
- 10-00=1 : Analog AI1 given (default)
- 10-00=2 : Analog AI2 given
- 10-00=3 : Communication given
- 10-00=4 : 10-02 given

(2) Select PID feedback value : PID feedback value selection(10-01)

- 10-01= 0 : Keypad given
- 10-01= 1 : Analog AI1 given
- 10-02= 2 : Analog AI2 given
- 10-03= 3 : Communication given

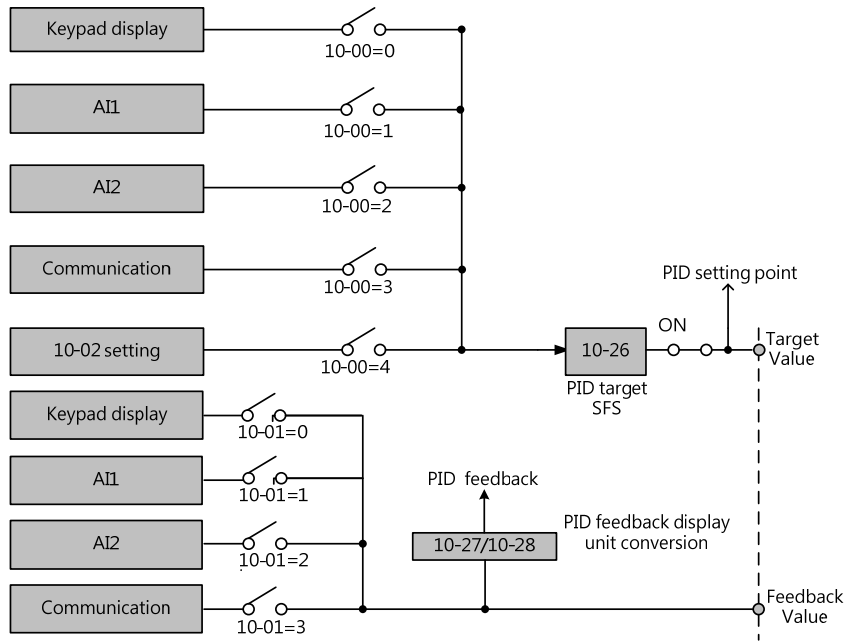

Figure 4.3.80 PID input selection

➤ PID Control Setting

PID control block diagram, the following figure shows PID control block diagram.

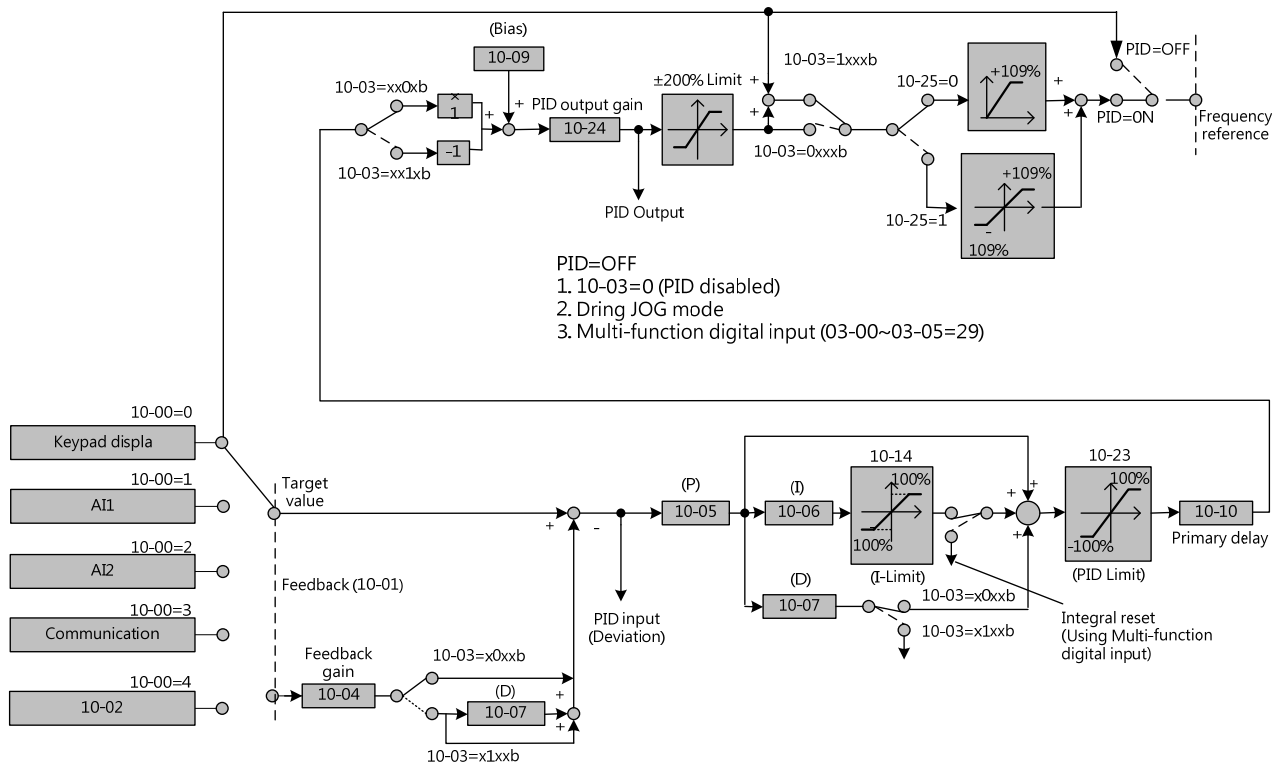

Figure 4.3.81 PID control block diagram

➤ **PID Tuning, use the following procedures to start PID control**

(1) Enable PID control

- Set 10-03 to a value greater than "xxx0b").
- Increase the proportional gain (10-05) to the highest value possible without causing the system to become unstable.
- Decrease the integral time (10-06) to the lowest value possible without causing the system to become unstable.
- Increase the differential time (10-07) to the highest value possible without causing the system to become unstable.

(2) The PID control serves to maintain a given process within certain limits whether it is pressure, flow etc. To do this the feedback signal is compared to the set value and the difference becomes the error signal for the PID control.

(3) PID output polarity can be selected with parameter 10-03 (setting = xx0xb: PID output forward, setting = xx1xb: PID output reversal). When PID output is chosen to reverse, and if PID input is negative, the output frequency of PID will gain. On the contrary, PID output is chosen to forward, and if PID input is minus, the output frequency of PID will decrease.

(4) PID feedback value can be adjusted using parameter 10-04 (PID feedback gain) as well as with the analog input gain and bias for terminal AI1 or AI2. 10-14 (Integral Limit) Used to limit the integral output to prevent motor stall or damage to the system in case of a rapid change in the feedback signal. Reduce the value of 10-14 to increase the inverter response.

➤ **PID Bias (10-09)**

Used to adjust the offset of the PID control. The offset value is added to the frequency reference as compensation. Use parameter 10-24 (PID output gain) to control the amount of compensation.

➤ **PID Limit (10-23)**

Used to limit the output of the PID control. Maximum output frequency is 100%.

➤ **PID Output gain (10-24)**

Used to adjust the compensation. Use parameter 10-24 to adjust the compensation to output frequency.

➤ **PID reversal output selection (10-25)**

In case the PID control output value goes negative, parameter 10-25 (PID reversal output selection) can be used to reverse the motor direction.

➤ **PID target acceleration/deceleration time (10-26)**

Sets the PID target value acceleration and deceleration ramp time. The acceleration/deceleration time is set to 00-14~17 and 00-21~24. Reduce the acceleration/deceleration time in case load resonance or system instability is encountered.

➤ **PID Fine Tuning**

All PID control parameters are related to each other and require to be adjusted to the appropriate values. Therefore, the procedure achieving the minimum steady-state is shown as following

- (1) Increase or decrease the proportion (P) gain until the system is stable using the smallest possible control change.
- (2) The integral (I) reduces the system stability which is similar to increasing the gain. Adjust the integral time so that the highest possible proportional gain value can be used without affecting the system stability. An increase in the integral time reduces system response.
- (3) Adjust the differential time if necessary to reduce overshoot on startup. The acceleration/ deceleration time can also be used for the same purpose.

➤ **Fine-tuning PID control parameters :**

(1) **Reduce overshoot**

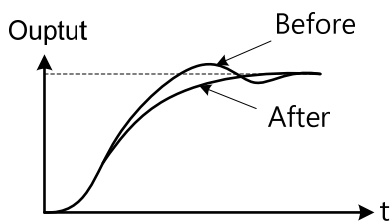

In case overshoot occurs, reduce the derivative time (D) and increase the integral time (I).

(2) **Stabilize PID control**

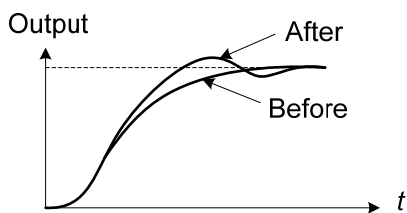

To quickly stabilize the PID control, reduce the integral time (I) and increase the differential time (D) in case overshoot occurs.

(3) **Reduce long-period oscillation**

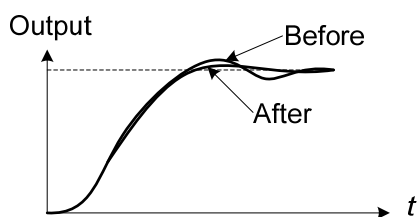

Adjust the integral time (I) in case of long-periodical system oscillation.

(4) **Reduce short-period oscillation**

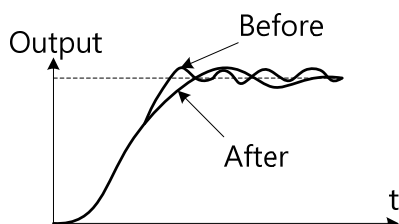

Adjusting the differential time (D) and proportional (P) gain when experiencing short-periodical oscillation.

10-11	PID feedback loss detection selection
Range	【0】 : Disable 【1】 : Warning 【2】 : Fault
10-12	PID feedback loss detection level
Range	【0~100】 %
10-13	PID feedback loss detection time
Range	【0.0~25.5】 Sec

The PID control function provides closed-loop system control. In case PID feedback is lost, the inverter output frequency may be increase to the maximum output frequency.

➤ **Warning (10-11=1)**

A feedback loss condition is detected when the PID feedback value falls below the value set in parameter 10-12 (PID feedback loss detection level) for the time set in parameter 10-13 (PID feedback loss detection time). PID feedback loss warning message "Fb" will be displayed on the keypad and the inverter will continue to operate.

➤ **Fault (10-11=2)**

A feedback loss condition is detected when the PID feedback value falls below the value set in parameter 10-12 (PID feedback loss detection level) for the time set in parameter 10-13 (PID feedback loss detection time). PID feedback loss fault message "Pb" will be displayed on the keypad, the inverter stops and the fault contact is activated.

➤ Refer to figure 4.3.82

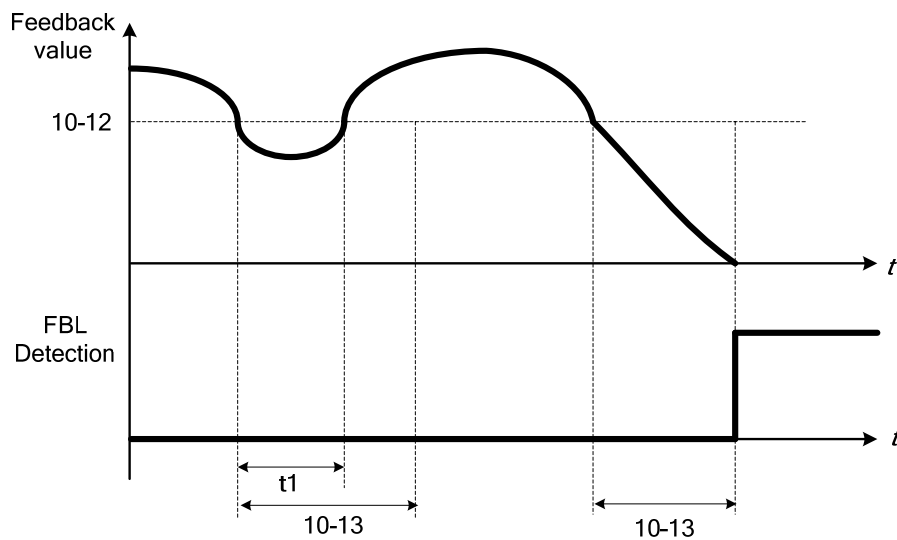

Figure 4.3.82 PID feedback loss detection

10-17	Start frequency of PID sleep
Range	【0.00~599.00】 Hz
10-18	Delay time of PID sleep
Range	【0.0~255.5】 Sec
10-19	Frequency of PID wakeup
Range	【0.00~599.00】 Hz
10-20	Delay time of PID wakeup
Range	【0.0~255.5】 Sec
10-29	PID sleep selection
Range	【0】 : Disable 【1】 : Enable 【2】 : Set by DI
10-40	Selection of PID Sleep Compensation Frequency
Range	【0】 : Disable 【1】 : Enable

- For energy saving requirement, motor will start/stop according to PID sleep/wake up function.
- Refer to figure 4.3.83 (a), (b) and (c) for PID sleep/wakeup operation :

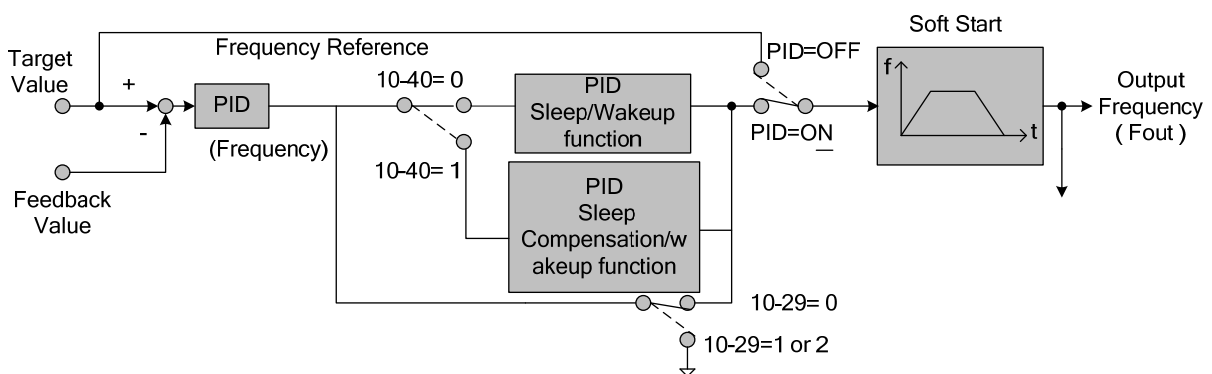

Figure 4.3.83 (a) PID control block diagram

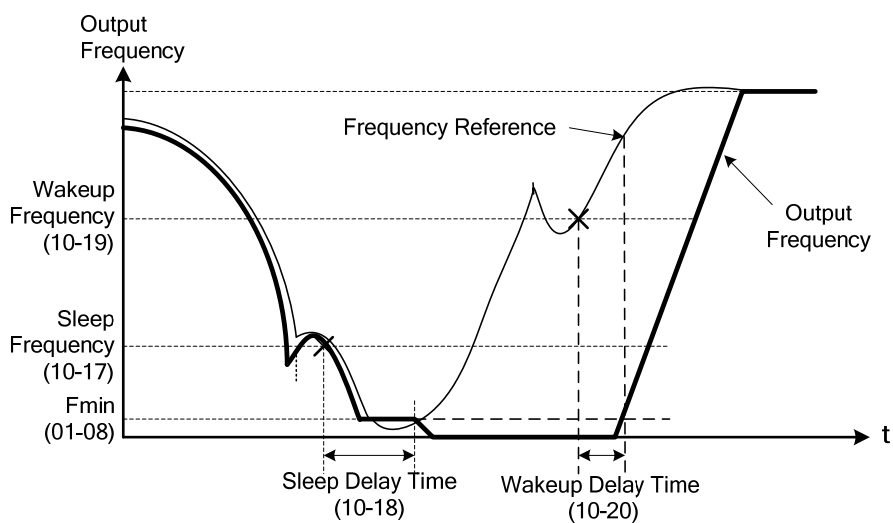

Figure 4.3.83 (b) Timing diagram PID sleep / wakeup

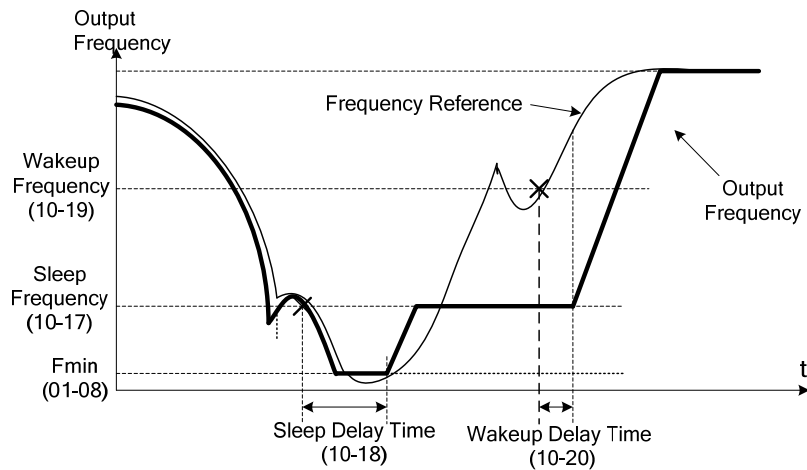

Figure 4.3.83 (c) Timing diagram of PID sleep compensation/ wakeup

➤ **10-40=0, refer to Figure 4.3.83(b)**

The PID sleep timer is enabled when the output frequency (F_{out}) falls below the PID sleep frequency (10-17). When the sleep timer reaches the set PID sleep delay time (10-18) the inverter will decelerate to a stop and enter the sleep mode.

➤ **10-40=1, refer to Figure 4.3.83(c)**

When output frequency (F_{out}) is lower than PID sleep frequency set by 10-17, Timer of PID sleep mode will run and the output frequency changes with the reference frequency (F_{ref}) until it reaches the minimum output frequency (F_{min}) set by 01-08. When the PID sleep delay time (10-18) is completed, the motor will run gradually to the PID sleep frequency set by 10-17.

While sleep mode is active and the motor has stopped, the internal PID control is still in operating. When the reference frequency increases and exceeds the wakeup frequency parameter 10-19 for the time specified in the wakeup delay time parameter 10-20, the inverter will restart and the output frequency will ramp up to the reference frequency.

Example :

- (1) When wakeup frequency less than sleep frequency, inverter starts by the sleep frequency and sleeps depending on sleep frequency.
- (2) When wakeup frequency greater than sleep frequency, inverter starts by the wakeup frequency and sleeps depending on sleep frequency.

➤ Parameter 10-00 and 10-01 can not be set to the same source. If both parameters are set to the same source the keypad will show a " SE05 " alarm.

➤ When 10-29=1 or 2 and then 10-25=1, inverter will show a " SE05 " alarm.

➤ When 10-29=1 or 2, and then set 10-03=1xxxb, inverter will show a " SE05 " alarm.

➤ When 10-29= 0 : PID sleep function is disabled.

When 10-29= 1 : PID sleep operation is based on parameter 10-17 and 10-18.

When 10-29= 2 : PID sleep function is started by multi-function digital input terminal.

10-27	PID Feedback Display Bias
Range	【0~9999】

- PID feedback value bias can be monitored by parameter 10-27 (PID feedback bias display).
- Example : The feedback signal of 0-10V / 4-20mA is a pressure transducer.

Refer to the figure 4.3.84 for displaying the unit conversion.

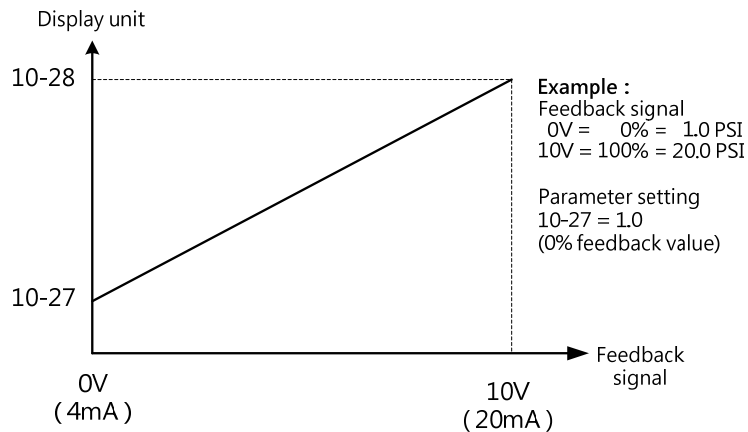

Figure 4.3.84 Feedback signal scaling

Example :
 Feedback signal : 0V=0%=1.0 PSI · 10V=100%=20.0 PSI
 Parameter setting : 10-27=10 (0% feedback value)
 10-33=200 (100% feedback value)

10-30	Upper Limit of PID Target
Range	【0 ~ 100】 %
10-31	Lower Limit of PID Target
Range	【0 ~ 100】 %

- Target value of PID will be limited to the range of upper & lower limit of PID target.

10- 33	Maximum Value of PID Feedback
Range	【1~10000】
10- 34	PID Decimal Width
Range	【0~4】
10- 35	PID Unit
Range	【0~23】

- When 10-33 (the maximum value of PID feedback) is active, it will become 100% the corresponding value of 10-02.
- Parameter 10-34 (PID decimal width) is used for rounding up setting.
 For example : set 10-34=1, it displays XXX.X ; set 10-34=2, it displays XX.XX.
- Parameter 10-35 (PID unit) is selected depending on user’s needs.

Note : When user switches PID in LED keypad, 10-33 is required to be lower than 1000 and 10-34=1, otherwise the keypad will show a “SE05” alarm (PID setting error).

10- 39	Output Frequency Setting of PID Disconnection
Range	【0.00~599.00】 Hz

- When PID feedback disconnection is in alarm, frequency command output depends on the setting value of 10-39. If the warning is lifted, PID control is restored.

10- 47	Proportioanl Gain (P) of Fire Mode
Range	【0.00~10.00】
10- 48	Integral Time (I) of Fire Mode
Range	【0.0~100.0】 Sec
10- 49	Differential Time (D) of Fire Mode
Range	【0.00~10.00】 Sec

- PID functions of fire mode, please refer to parameter group 08.

Group 11 Auxiliary Parameters

11-00	Direction Lock Selection
Range	【0】 : Allow forward and reverse rotation 【1】 : Only allow forward rotation 【2】 : Only allow reverse rotation

- If motor operation direction is set to 1 or 2, the motor can only operate in that specific direction. Run commands in the opposite direction are not accepted.
- Forward or reverse commands can be issued via the control terminals or keypad.
- Parameter 11-00 can be used in fan and pump application where reverse rotation is prohibited.

11-01	Carrier frequency
Range	【1~16】 kHz

- (1) Setting range from 1 to 16 represents kHz.
- (2) Setting range is determined by the inverter rating (13-00) and HD/ND mode (00-27).

A low carrier frequency decreases RFI, EMI interference and motor leakage current. Please refer to the carrier frequency table 4.3.35

Table 4.3.35 Carrier frequency settings

Carrier Frequency	1kHz	6kHz	10kHz	16kHz
Motor noise	High	-----	-----	Low
Output current waveform (similar to sinusoidal wave)	Bad	-----	Good	-----
Noise interference	Low	-----	-----	High
Leakage current	Low	-----	-----	High
Heat loss	Low	-----	-----	High

- Refer to section 3 inverter derating based on carrier frequency.
- [Lower capacity inverter can use higher carrier frequency, please refer section 3.](#)
- A low carrier frequency increases motor noise but reduces motor losses and temperature.
- If cable length between the inverter and the motor is too long, the high-frequency leakage current will cause an increase in inverter output current, which might affect peripheral devices.

Adjust the carrier frequency to avoid this as shown in table 4.3.36.

Table 4.3.36 Cable length and carrier frequency

Wire length	< 30m (<98ft)	<50m (<164ft)	<100m (<328ft)	>100m (>328ft)
Carrier frequency (11-01 value)	Max value 16kHz (11-01=16kHz)	Max value 10kHz (11-01=10kHz)	Max value 5kHz (11-01=5kHz)	Max value 2kHz (11-01=2kHz)

- Reduce the carrier frequency if the torque does not match the speed.

11-02	Soft PWM Function Selection
Range	【0】 : Disable 【1】 : Soft PWM

➤ 11-02=1 : Soft PWM

Soft PWM control can improve the metal noise produced by the motor, more comfortable for the human ear. At the same time, Soft PWM also limits RFI noise to a minimum level. The default setting of Soft PWM control is disabled. The maximum carrier frequency of soft PWM mode is 8kHz.

11-03	Automatic Carrier Lowering Selection
Range	【0】 : Disable 【1】 : Enable

If inverter detects overheating situation, carrier will be reduce automatically. When overheating situation is removed, carrier will back to the value of 11-01.

- When 11-03=0, carrier frequency operation will be set by 11-01.
- When 11-03=1, carrier frequency is automatically lowered when the inverter temperature is higher than the setting value, to reduce the heat loss and avoid the over-heat trip of inverter.
- When inverter temperature (12-41) higher than 80°C, carrier frequency will decrease to 4KHz automatically and will go back to the value of 11-01 once inverter temperature lower than 70°C.

11-04	S Curve Time Setting at the Start of Acceleration
11-05	S curve time setting at the End of Acceleration
11-06	S curve time setting at the Start of Deceleration
11-07	S curve time setting at the End of Deceleration
Range	【0.00~2.50】 Sec

- The S curve function for acceleration / deceleration is used to reduce mechanical impact caused by the load during momentary starting and stopping of the inverter. To use the S curve function set the time for acceleration start point (11-04), acceleration end point (11-05), deceleration start point (11-06) and deceleration end point (11-07). Refer to figure 4.3.85.

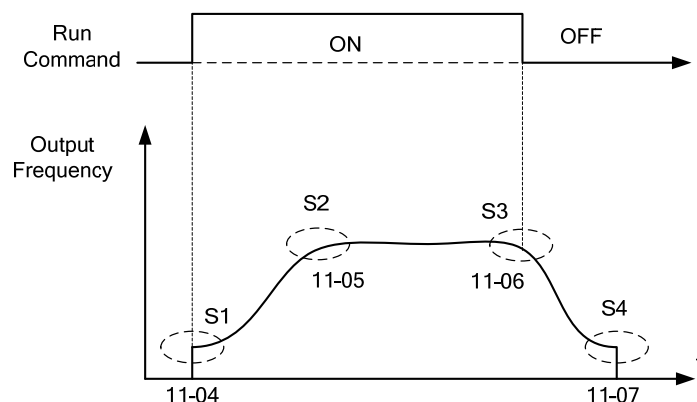

Figure 4.3.85 S curve characteristic

- Total acceleration and deceleration time when S curve is used :

$$\text{Acceleration time} = \text{Acceleration time 1 (or 2)} + \frac{(11-04) + (11-05)}{2}$$

$$\text{Deceleration time} = \text{Deceleration time 1(or 2)} + \frac{(11-06) + (11-07)}{2}$$

11-08	Jump Frequency 1
11-09	Jump Frequency 2
11-10	Jump Frequency 3
Range	【0.0~599.0】 Hz
11-11	Jump Frequency Width
Range	【0.0~30.0】 Hz

- These parameters allow “jumping over” of certain frequencies that can cause unstable operation due to resonance within certain applications.
- Prohibit any operation within the jump frequency range. During acceleration and deceleration the frequency is continuous without skipping the jump frequency.
- To enable jump frequency 1-3 (11-08 to 11-10) set the frequency to a value greater than 0.0Hz.
- Use the jump frequency width (11-11) to create a jump frequency range.
- Refer to figure 4.3.86

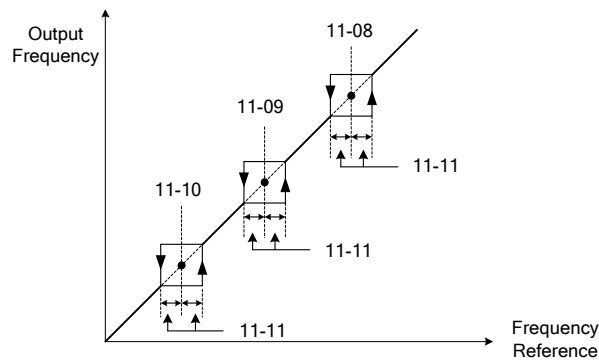

Figure 4.3.86 Jump frequency operation

- Set parameter 04-05 (AI2 function selection) to 9 (frequency jump setting 4) to control the jump frequency via analog input AI2. Refer to figure 4.3.48.
- When jump frequency overlap the sum of the overlapped jump frequencies will be used as the jump frequency range. Refer to figure 4.3.87 °

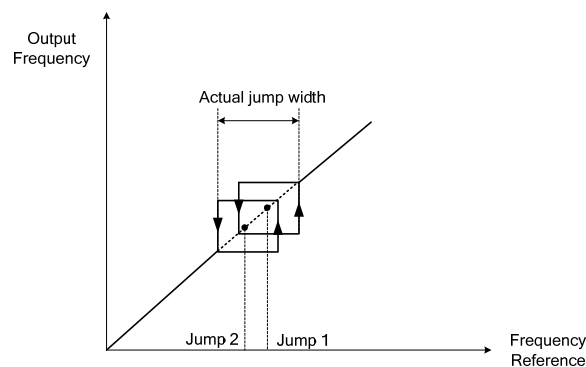

Figure 4.3.87 Jump frequency overlap

11- 12	Manual Energy Saving Gain (VF)
Range	【0~100】 %
11- 18	Manual Energy Saving Frequency
Range	【0.0~599.0】 Hz

- To enable manual energy savings to one of the digital input (03-00 to 03-05=20) to 20.
- Manual energy savings reduces the output voltage for the purpose of saving energy

- **Manual energy saving gain (11-12)**
 - (1) When manual energy savings is enabled, output voltage of inverter will be determined by parameter 11-12, output voltage is percentage gain times the V/F voltage.
 - (2) Manual energy saving control uses the voltage recovery time (07-23) to change the output voltage.

- **Manual energy saving frequency (11-18)**
 Setting parameter 11-18 manual energy savings frequency to 0.0 Hz disables the manual energy savings frequency activation function. Refer to figure 4.3.88

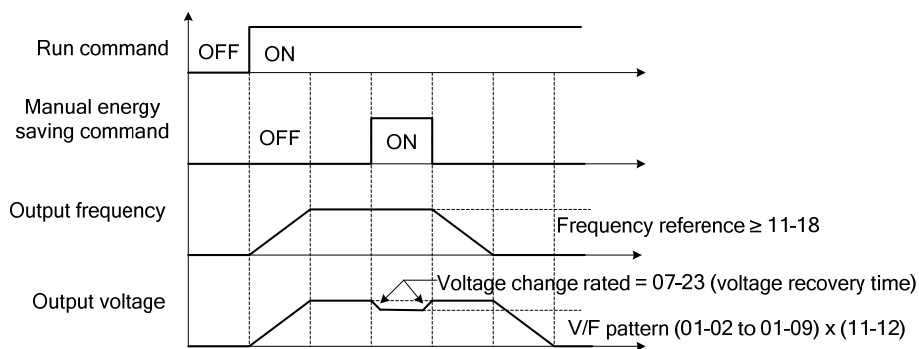

Figure 4.3.88 Manual energy saving operation

11- 14	OV Prevention Level
Range	230V : 【200~400】 V 400V : 【400~800】 V
11- 17	Acceleration/Deceleration Gain
Range	【0.1~10.0】

- **Parameter setting :**
 - (1) If “OV” alarm still happened when 11-40=3, please increase the value of 11-17 in 0.1 unit.
 - (2) If the setting value of 11-17 is not suitable, the ripple of speed and current will be higher.
 (11-14 is the target voltage of over-voltage prevention mode 3, it's the voltage inhibition level.)

11- 28	Frequency Gain of Over Voltage Prevention 2
Range	【1~200】 %
11- 33	DC Voltage Filter Rise Amount
Range	【0.1~10.0】 V
11- 34	DC Voltage Filter Fall Amount
Range	【0.1~10.0】 V

11- 35	DC Voltage Filter Deadband Level
Range	【0.0~99.0】 V
11- 36	Frequency gain of OV Prevention
Range	【0.000~1.000】
11- 37	Frequency limit of OV Prevention
Range	【0.00~599.00】 Hz
11- 38	Deceleration start voltage of OV prevention
Range	230V : 【200~400】 V 400V : 【400~800】 V
11- 39	Deceleration end voltage of OV Prevention
Range	230V : 【300~400】 V 400V : 【600~800】 V
11- 40	OV Prevention Selection
Range	【0】 : Disable 【1】 : OV prevention Mode 1 【2】 : OV prevention Mode 2 【3】 : OV prevention Mode 3

Over-voltage suppression is used for the application of likely causing to energy recharge.

Example :

There are two situations causing excessive energy to recharge the inverter in stamping application.

- (1) When cam clutch is not engaged, the motor will accelerate and start flywheel. When motor decelerates, the rotation speed will higher than motor speed owing to the large flywheel's inertia and then recharge the inverter.
- (2) When cam clutch is engaged, the motor will start flywheel and compress the spring. When the highest point of the cam moves beyond its center, the spring will release the power to the flywheel and excessive energy output recharge the inverter.

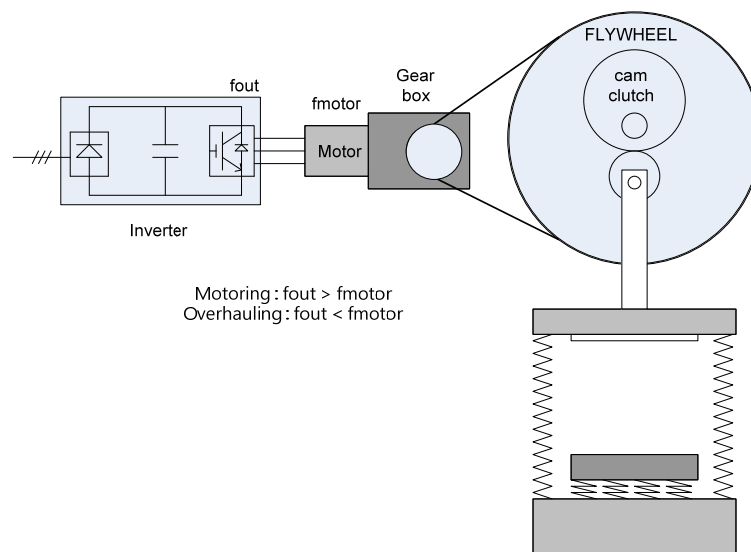

Figure 4.3.90 Stamping Operation

- Over-voltage prevention (OVP) function monitors the DC-bus voltage and adjusts the speed reference, acceleration and deceleration rate, to prevent the inverter from tripping on an overvoltage.
- When the speed reference is reduced, the motor will start to decelerate. When the inverter is operating at a fixed output frequency and excessive regenerative energy back to the inverter is detected, the inverter will accelerate the motor in order to reduce the DC-bus voltage. Refer to figure 4.3.91.

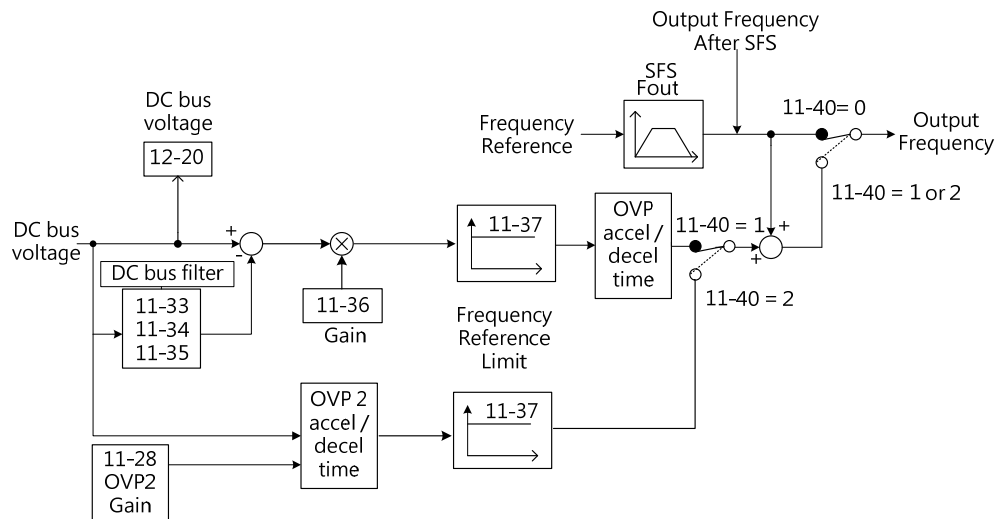

Figure 4.3.91 OVP Operation

➤ **When 11-40=1 : OV Prevention Mode 1**

- (1) DC voltage filter is used to provide a stable reference value for determining the change in DC voltage change during regenerative operation.
 - Adjust the DC voltage filtering increase rate parameter 11-33 (DC Voltage Filter Rise Amount). When the DC voltage exceeds 11-33 + 11-35 (DC Voltage Filter Deadband Level), the output of the filter will increase.
 - Adjust the DC voltage filtering decrease rate parameter 11-34 (DC Voltage Filter Fall Amount). When the DC voltage exceeds 11-33 + 11-35 (DC Voltage Filter Deadband Level), the output of the filter will decrease.
 - Monitor the DC voltage filter output by 12-20 (DC voltage filter value).
 - Set the DC voltage filter decrease rate (11-34) to a greater value than the value of the DC voltage filtering increase rate (11-33).
- (2) When the inverter is operation at a fixed output frequency, the OVP function will monitor the DC-bus voltage to detect regenerative operation
 - In case of a regenerative condition the inverter calculates the delta DC bus voltage value and multiplies the value with parameter 11-36, the result is added to the frequency reference accelerating the motor to prevent on an overvoltage condition.
 - When the regenerative energy decreases, the inverter output frequency will return to the actual frequency reference. Deceleration rate is based on the DC voltage, as shown in figure 4.3.92.

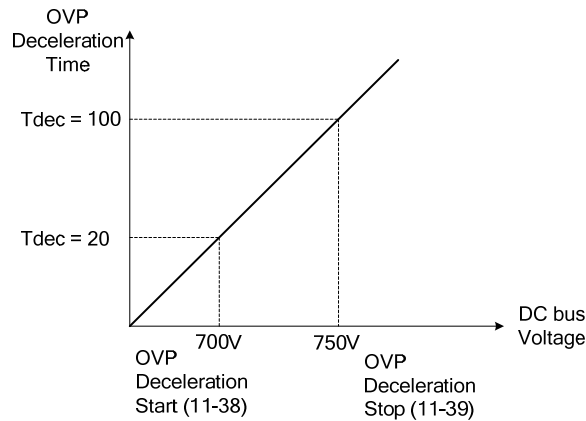

Figure 4.3.92 OVP deceleration time

(3) When the inverter is stopped, the deceleration rate can be set with parameter 00-15(Tdec1). In case the DC voltage is too high, the inverter will decelerate based on the OVP deceleration time as shown in figure 4.3.92

- Set DC-bus voltage in parameter 11-38 (start voltage of OVP deceleration) and set OVP deceleration rate in 00-22 (Tdec3).
- When the DC voltage reaches this level, it is necessary to decelerate rapidly in order to prevent the delta DC voltage of becoming too large.
- When DC voltage reaches the setting of 11-39 (stop voltage of OVP deceleration), it will decelerate based on the set value of 00-24 (Tdec4)
- Deceleration rate is linear based on the slope defined by the start point (11-38) and end point (11-39).

(4) Parameter 11-40 can enable and disable the OVP function, when 11-40=1, some functions will go back to default setting.

00-14(Tacc1)=5.0 sec (Acceleration speed reference of higher DC voltage)

00-22(Tdec3)=20.0 sec (OVP deceleration lower setting point)

00-24(Tdec4)=100.0 sec (OVP deceleration higher setting point)

11-04=0.0 sec

11-05=0.0 sec (OVP S-curve function needs to disable)

11-06=0.0 sec

11-07=0.0 sec

➤ **When 11-40=2 : OV prevention Mode 2**

The process of OV prevention mode 2 is the same as that of OV prevention mode 1 but it strengthens more the part of DC BUS over the deceleration stop voltage of OV prevention (11-39) in Fig.4.3.92. It can accelerate frequency compensation to avoid OV protection by increasing frequency gain of OV prevention 2 (11-28).

➤ **When 11-40=3 : OV prevention Mode 3**

The inverter raise the output frequency temporarily to avoid OV, the output frequency won't higher than 01-02 (Maximum Output Frequency of Motor 1).Please adjust 01-02 according to each application. If it still occurs "OV" in this mode, please raise the value of 11-17 in 0.1 unit. (When 11-17 value is higher, the speed and current ripple will be raised.)

11- 47	KEB Deceleration Time
Range	【0.0~25.5】 Sec
11- 48	KEB Detection Level
Range	230V : 【190~210】 V 400V : 【380~420】 V

KEB function can be used to keep the inverter from tripping on a under voltage condition due to a momentary power-loss. To enable the KEB function set parameter 11-47 to a value greater than 0.0 sec. Upon detection of a power-loss the inverter uses the KEB deceleration time (11-47) to decelerate the motor and using the regenerative energy from the motor to maintain the DC-bus at a nominal level.

➤ **KEB Deceleration Time (11-47)**

- (1) When 11-47=0, KEB function is disabled.
- (2) Set 11-47 (KEB deceleration time) from 0.0 to 25.5.

➤ **KEB Detection Level (11-48)**

If the DC-bus voltage falls below the value set in 11-48, the KEB is activated and the inverter starts decelerating according to the value set in 11-47. To accelerate back to the original output frequency one of the digital inputs (03-00 to 03-07) set for 48 (KEB acceleration) has to be activated and the DC voltage has to rise above 11-48 + delta V (Delta V = +10V for 230V series, Delta V = +20 V for 400V Series), refer to the example in figure 4.3.95.

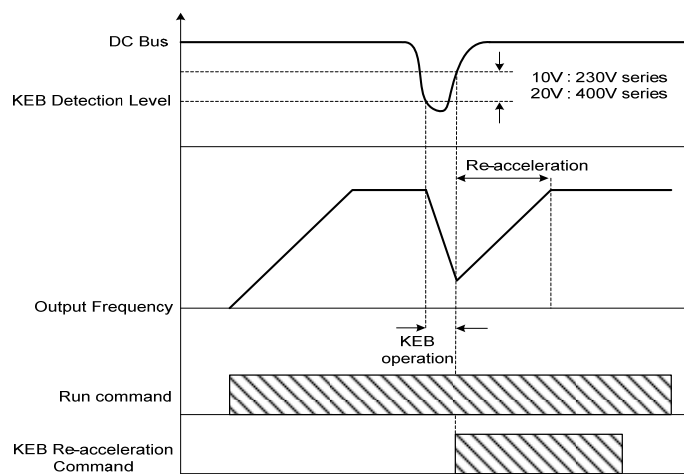

Figure 4.3.95 KEB operation

11- 55	STOP Key Selection
Range	【0】 : Stop key is disabled when the operation command is not provided by operator 【1】 : Stop key is enabled when the operation command is not provided by operator

This function can enable or disable the stop key of keypad display when 00-02=1 (external terminal) or 00-02=3 (communication).

- 11-55= 0 : Stop button disabled.
- 11-55= 1 : Stop button enabled.

11- 59	Gain of Preventing Oscillation
Range	【0.00~2.50】

- It is used to adjust preventing oscillation function.
- If the oscillation in driving motor occurs at normal duty, it is required to increase the setting value gradually in the unit of 0.01.

11- 60	Upper Limit of Preventing Oscillation
Range	【0~100】 %

- It is required to limit the preventing oscillation upper limit within the setting value.

11- 61	Time Parameter of Preventing Oscillation
Range	【0~100】

- Adjust the response of oscillation function. (Time parameter of adjust preventing oscillation function delay.)

11- 62	Selection of Preventing Oscillation
Range	【0】 : Mode 1 【1】 : Mode 2 【2】 : Mode 3

- When 11-62=0 (Mode1) and 1 (Mode 2) : The response to preventing oscillation is slower.
- When 11-62=2 (Mode 3) : The response to preventing oscillation is faster.

11- 63	Strong Magnetic Selection
Range	【0】 : Disable 【1】 : Enable

- When 11-63=0 :
It has no function of flux-strengthening, the no-load current of high speed and low speed are the same.
- When 11-63=1 :
It has function of flux-strengthening, the torque of low speed is higher, but the no-load current is also higher, it is suitable for big load in low speed.

11- 66	2/3 Phase PWM Switch Frequency
Range	【6.00~60.00】

- Inverter will switch the PWM mode automatically when the output frequency is higher than 11-66.

11- 67	RPWM Frequency Bias
Range	【0~12000】
11- 68	RPWM Switch Frequency
Range	【6.00~60.00】

- When inverter output frequency is higher than 11-68, the noise detection function will be enabled. Inverter will change the eccentric magnetic noise in operation according to the different setting value of parameter 11-67.

Note :

When 11-02=2, the sum of 11-01+11-67 can not higher than the upper limit of carrier frequency, please refer to the following points :

- (1) If it gets error for setting 11-01, it means 11-02=2 and the sum of 11-66+11-67 is higher than the upper limit of carrier frequency, please try to adjust the value of 11-02 or 11-67.
- (2) If it gets error for setting 11-67, it means 11-02=2 and the sum of 11-66+11-67 is higher than the upper limit of carrier frequency, please try to adjust the value of 11-02 or 11-01.
- (3) When 11-01=2, then gets error for setting 11-01 or 11-67, please check whether the sum of 11-66+11-67 is higher than the upper limit of carrier frequency.
- (4) If it gets error for setting 11-02=2, it means the sum of 11-66+11-67 is higher than the upper limit of carrier frequency, please adjust the value of 11-01 or 11-67 for suitable range, then set 11-02=2.

11- 69	Gain of Preventing Oscillation 2
Rang	【0.00~200.00】 %

- Adjust the response of Gain of Preventing Oscillation 3.
- If occur vibration with motor in ND mode, please increase by 0.01 unit to set.

11- 70	Upper Limit of Preventing Oscillation 2
Rang	【0.01~100】 %

- It is required to limit the preventing oscillation 3 upper limit within the setting value.

11- 71	Time Parameter of Preventing Oscillation 2
Rang	【0~30000】 mSec

- Adjust the response of oscillation 3 function.
(Time parameter of adjust preventing oscillation function delay.)

11- 72	Switching Frequency 1 of Preventing Oscillation 2
Rang	【0.01~300.00】 Hz
11- 73	Switching Frequency 2 of Preventing Oscillation 2
Rang	【0.01~300.00】 Hz

11-72(Switching Frequency 1) and 11-73(Preventing Oscillation 2) setting as the photo below.

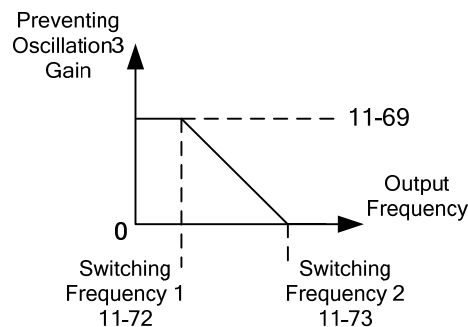

Group 12 Monitoring Parameters

12- 00	Display Screen Selection (LED)
Range	(Highest bit) <u>0</u> 0 0 0 <u>0</u> (Lowest bit) The value range if each bit is 0~8 from the highest bit to the lowest bit 【0】 : No display 【1】 : Output current 【2】 : No display 【3】 : DC busvoltage 【4】 : heatsink temperature 【5】 : PID feedback 【6】 : AI1 value 【7】 : AI2 value 【8】 : Counter

Notes :

The highest bit is used for power-up monitor. The 4 least significant bits can be used to customize the display sequence see page 4-4.

12- 01	PID Feedback Display Mode (LED)
Range	【0】 : Display the feedback value in integer (xxx) 【1】 : Display the feedback value with one place after the decimal point (xx.x) 【2】 : Display the feedback value (x.xx) with two places after the decimal point
12- 02	PID Feedback Display Unit Setting (LED)
Range	【0】 : xxxxx (no unit) 【1】 : xxxPb (pressure) 【2】 : xxxFL (flow)
12- 03	Line Speed Display (LED)
Range	【0~60000】 RPM
12- 04	Line Speed Display Mode (LED)
Range	【0】 : Display Inverter Output Frequency 【1】 : Line Speed Display at Integer. (xxxxx) 【2】 : Line Speed Display at One Decimal Place. (xxxx.x) 【3】 : Line Speed Display at Two Decimal Places. (xxx.xx) 【4】 : Line Speed Display at Three Decimal Places. (xx.xxx)

- When 12-04=0, Inverter displays the line speed at stop, operation or the modification of frequency.
- When 12-04≠0, 12-03 is set to the maximum line speed and corresponds to the maximum output frequency.

For example :

If the line speed display of 12-03 is 1800, the keypad display is 900 when frequency output is 30Hz.

12- 05	Status display of digital input terminal (LED / LCD)
Range	Read-only

- Terminal S1~S6 are represented using two segments of each digit. Segment turns on when input is active.

Example 1 :

S1/S3/S5/S6 are ON, S2/S4 are OFF, 12-05 will turn on when RY1 without output. (LED)

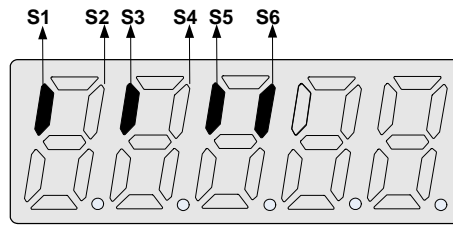

Example 2 :

S2/S3/S4 are ON, S1/S5/S6 are OFF, 12-05 will turn on when RY1/RY2/DO1 output at the same time.

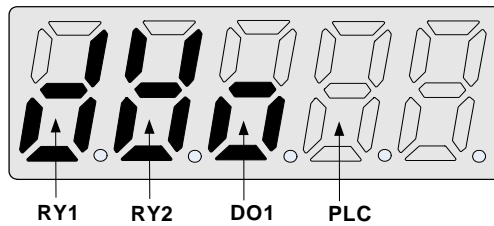

- Please refer section 4.2 for instruction of parameter 12-11~12-43.
- Please refer parameter setting of 12-38/12-39 for PID feedback and 10-33~10-35 for display.

Example 3 : S1~S6, RY1 and RY2 are OFF

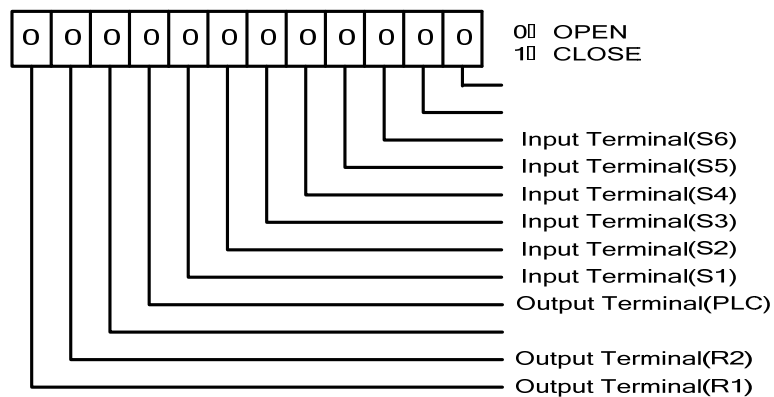

12- 43	Inverter Status (LED/LCD)
Range	Read Only (Only on keypad display)

- 12-43 Inverter status definition (some different with communication register 2520H)

Bit 0 : Inverter Ready	1 : Ready	0 : Not ready yet
Bit 1 : During Running	1 : Operation	0 : Stop
Bit 2 : During Zero Speed	1 : "ON"	
Bit 3 : During Speed Agree	1 : "ON"	
Bit 4 : During Warning Detection	1 : "ON"	
Bit 5 : During Fault Dtection	1 : Abnormal	

Example : When inverter stop running at zero speed, parameter 12-43 will display below (LCD display)

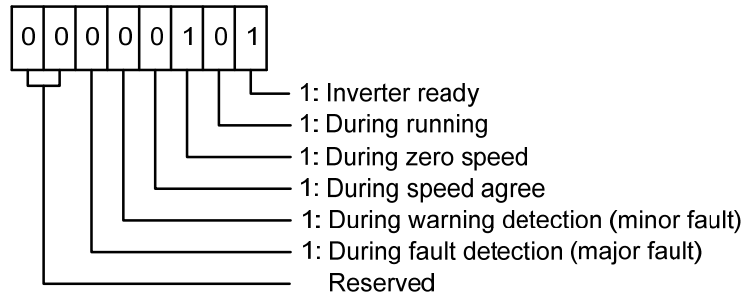

➤ Refer to section 4.2 for other monitor parameters 12-11~12-83
 Monitor parameter 12-38 (PID setting) and 12-39 PID (PID feedback) is required to refer to the descriptions of parameter 10-33~10-35.

Group 13 Maintenance Parameters

13- 00	Inverter Capacity Selection
Range	----

Inverter Model	13- 00 Display	Inverter Model	13- 00 Display
E510s-2P5	2P5	E510s-401	401
E510s-201	201	E510s-402	402
E510s-202	202	E510s-403	403
E510s-203	203	E510s-405	405
E510s-205	205	E510s-408	408
E510s-208	208	E510s-410	410
E510s-210	210	E510s-415	415
E510s-215	215	E510s-420	420
E510s-220	220	E510s-425	425
E510s-225	225	E510s-430	430
E510s-230	230	E510s-440	440
E510s-240	240	E510s-450	450
		E510s-460	460
		E510s-475	475

13- 01	Software Version
Range	----
13- 02	Fault Record
Range	----
13- 03	Cumulative Operation Hours 1
Range	【0~23】 hours
13- 04	Cumulative Operation Hours 2
Range	【0~65534】 days
13- 05	Selection of Cumulative Operation Time
Range	【0】 : Accumulative operation time while power on 【1】 : Accumulative operation time when it is operating.

- When 13-05=0, Inverter logs the time while the inverter is powered-up.
- When 13-05=1, Inverter logs the time when the inverter is running.

13- 06	Parameters lock
Range	【0】 : Parameters are read-only except 13-06 and main frequency 【1】 : Reserved 【2】 : All parameters are writable

Note :

Main frequency setting is 12-16. The value is equal to frequency setting of speed-stage 0 (05-01)

13- 08	Restore factory setting / Initialize
Range	<p>【1】 : 2 wires initialization (50Hz) (220V/380V)</p> <p>【2】 : 2 wires initialization (60Hz) (220V/380V)</p> <p>【3】 : 2 wires initialization (50Hz) (230V/400V)</p> <p>【4】 : 2 wires initialization (60Hz) (220V/460V)</p> <p>【5】 : 2 wires initialization (50Hz) (220V/415V)</p> <p>【6】 : 2 wires initialization (60Hz) (230V/400V)</p> <p>【7】 : 2 wires initialization (50Hz) (220V/440V)</p> <p>【8】 : 2 wires initialization (60Hz) (220V/440V)</p> <p>【9】 : 2 wires initialization (60Hz) (220V/380V)</p> <p>【10】 : 2 wires initialization (60Hz) (220V/380V)</p> <p>【1112】 : PLC initialization (RESET)</p>

Use parameter 13-08 to initialize the inverter to factory default. It is recommended to write down the modified parameters before initializing the inverter. After initialization, the value of 13-08 will return to zero automatically.

➤ **13-08=1 : 2 wires initialization (220V/380V)**

- (1) Multi-function digital input terminal S1 controls forward operation / stop command, and S2 controls reverse operation / stop command. Refer to figure 4.3.1.
- (2) Inverter input voltage (01-14) is automatically set to 220V (220V calss) or 380V (440V calss).
- (3) When 01-00 (V/F curve) = F, 01-02 will automatically set to 50Hz.

➤ **13-08=2 : 2 wires initialization (220V/380V)**

- (1) Multi-function digital input terminal S1 controls forward operation / stop command, and S2 controls reverse operation / stop command. Refer to figure 4.3.1.
- (2) Inverter input voltage (01-14) is automatically set to 220V (220V calss) or 380V (440V calss).
- (3) When 01-00 (V/F curve) = F, 01-02 will automatically set to 60Hz.

➤ **13-08=3 : 2 wires initialization (230V/400V)**

- (1) Multi-function digital input terminal S1 controls forward operation / stop command, and S2 controls reverse operation / stop command. Refer to figure 4.3.1.
- (2) Inverter input voltage (01-14) is automatically set to 220V (220V calss) or 400V (440V calss).
- (3) When 01-00 (V/F curve) = F, 01-02 will automatically set to 50Hz.

➤ **13-08=4 : 2 wires initialization (230V/460V)**

- (1) Multi-function digital input terminal S1 controls forward operation / stop command, and S2 controls reverse operation / stop command. Refer to figure 4.3.1.
- (2) Inverter input voltage (01-14) is automatically set to 220V (220V calss) or 460V (440V calss).
- (3) When 01-00 (V/F curve) = F, 01-02 will automatically set to 60Hz.

➤ **13-08=5 : 2 wires initialization (220V /415V)**

- (1) Multi-function digital input terminal S1 controls forward operation / stop command, and S2 controls reverse operation / stop command. Refer to figure 4.3.1.
- (2) Inverter input voltage (01-14) is automatically set to 220V (220V calss) or 415V (440V calss).
- (3) When 01-00 (V/F curve) = F, 01-02 will automatically set to 50Hz.

➤ **13-08=6 : 2 wires initialization (230V/400V)**

- (1) Multi-function digital input terminal S1 controls forward operation / stop command, and S2 controls reverse operation / stop command. Refer to figure 4.3.1.
- (2) Inverter input voltage (01-14) is automatically set to 230V (220V calss) or 400V (440V calss).
- (3) When 01-00 (V/F curve) = F, 01-02 will automatically set to 60Hz.

➤ **13-08=7 : 2 wires initialization (220V/440V)**

- (1) Multi-function digital input terminal S1 controls forward operation / stop command, and S2 controls reverse operation / stop command. Refer to figure 4.3.1.
- (2) Inverter input voltage (01-14) is automatically set to 220V(220V calss) or 440V(440V calss).
- (3) When 01-00 (V/F curve) = F, 01-02 will automatically set to 50Hz.

➤ **13-08=8 : 2 wires initialization (220V/440V)**

- (1) Multi-function digital input terminal S1 controls forward operation / stop command, and S2 controls reverse operation / stop command. Refer to figure 4.3.1.
- (2) Inverter input voltage (01-14) is automatically set to 220V(220V calss) or 440V(440V calss).
- (3) When 01-00 (V/F curve) = F, 01-02 will automatically set to 60Hz.

➤ **13-08=9 : 2 wires initialization (220V/380V)**

- (1) Multi-function digital input terminal S1 controls forward operation / stop command, and S2 controls reverse operation / stop command. Refer to figure 4.3.1.
- (2) Inverter input voltage (01-14) is automatically set to 220V(220V calss) or 380V(440V calss).
- (3) When 01-00 (V/F curve) = F, 01-02 will automatically set to 50Hz.

➤ **13-08=10 : 2 wires initialization (220V/380V)**

- (1) Multi-function digital input terminal S1 controls forward operation / stop command, and S2 controls reverse operation / stop command. Refer to figure 4.3.1.
- (2) Inverter input voltage (01-14) is automatically set to 220V(220V calss) or 380V(440V calss).
- (3) When 01-00 (V/F curve) = F, 01-02 will automatically set to 60Hz.

➤ **13-08=1112 : PLC initialization**

Clear built-in PLC ladder logic and related values.

- The following parameters will not be influenced by restore factory setting (13-08)

No.	Parameters
00-00	Control Mode Selection
00-34	Language selection
00-27	HD/ND Mode Selection
01-00	V/F Curve Selection
01-26	V/F Curve Selection of Motor 2
13-00	Inverter Capacity Selection
13-03	Cumulative Operation Hours 1
13-04	Cumulative Operation Hours 2
13-05	Selection of Cumulative Operation Time

13- 10	Parameter Password Function 2
Range	【0~9999】
13- 51	Clear Cumulative Operation Hours
Range	【0】 : Disable to Clear Cumulative Operation Hours 【1】 : Clear Cumulative Operation Hours

Group 14 PLC Parameters

14- 00	T1 set value 1
14- 01	T1 set value 2 (mode 7)
14- 02	T2 set value 1
14- 03	T2 set value 2 (mode 7)
14- 04	T3 set value 1
14- 05	T3 set value 2 (mode 7)
14- 06	T4 set value 1
14- 07	T4 set value 2 (mode 7)
14- 08	T5 set value 1
14- 09	T5 set value 2 (mode 7)
14- 10	T6 set value 1
14- 11	T6 set value 2 (mode 7)
14- 12	T7 set value 1
14- 13	T7 set value 2 (mode 7)
14- 14	T8 set value 1
14- 15	T8 set value 2 (mode 7)
Range	【0~9999】

14- 16	C1 set value
14- 17	C2 set value
14- 18	C3 set value
14- 19	C4 set value
14- 20	C5 set value
14- 21	C6 set value
14- 22	C7 set value
14- 23	C8 set value
Range	【0~65534】

14- 24	AS1 set value 1
14- 25	AS1 set value 2
14- 26	AS1 set value 3
14- 27	AS2 set value 1
14- 28	AS2 set value 2
14- 29	AS2 set value 3
14- 30	AS3 set value 1
14- 31	AS3 set value 2
14- 32	AS3 set value 3
14- 33	AS4 set value 1
14- 34	AS4 set value 2
14- 35	AS4 set value 3
Range	【0~65534】

14- 36	MD1 set value 1
14- 37	MD1 set value 2
14- 39	MD2 set value 1
14- 40	MD2 set value 2
14- 42	MD3 set value 1
14- 43	MD3 set value 2
14- 45	MD4 set value 1
14- 46	MD4 set value 2
Range	【0~65534】
14- 38	MD1 set value 3
14- 41	MD2 set value 3
14- 44	MD3 set value 3
14- 47	MD4 set value 3
Range	【1~65534】

Please refer to section [4.4](#) for built-in PLC function

Group 15 PLC Monitoring Parameters

15- 00	T1 Current Value1
15- 01	T1 Current Value 2 (Mode7)
15- 02	T2 Current Value 1
15- 03	T2 Current Value 2 (Mode7)
15- 04	T3 Current Value 1
15- 05	T3 Current Value 2 (Mode7)
15- 06	T4 Current Value 1
15- 07	T4 Current Value 2 (Mode7)
15- 08	T5 Current Value 1
15- 09	T5 Current Value 2 (Mode7)
15- 10	T6 Current Value 1
15- 11	T6 Current Value 2 (Mode7)
15- 12	T7 Current Value 1
15- 13	T7 Current Value 2 (Mode7)
15- 14	T8 Current Value 1
15- 15	T8 Current Value 2 (Mode7)
Range	【0~9999】

15-16	C1 Current Value
15-17	C2 Current Value
15-18	C3 Current Value
15-19	C4 Current Value
15-20	C5 Current Value
15-21	C6 Current Value
15-22	C7 Current Value
15-23	C8 Current Value
Range	【0~65534】

15-24	AS1 Current Value
15-25	AS2 Current Value
15-26	AS3 Current Value
15-27	AS4 Current Value
15-28	MD1 Current Value
15-29	MD2 Current Value
15-30	MD3 Current Value
15-31	MD4 Current Value
15-32	TD Current Value
Range	【0~65534】

Group 16 LCD Function Group

16- 00	Main Screen Monitoring
Range	【5~83】
16- 01	Sub-Screen Monitoring 1
Range	【5~83】
16- 02	Sub-Screen Monitoring 2
Range	【5~83】

- At power-up the inverter shows two monitor section on the display, main monitor section and the sub-screen monitor section (smaller font).
- Choose the monitor signal to be displayed as the main-screen monitor screen in parameter 16-00, and the monitor signals to be displayed on the sub-screen monitor in parameters 16-01 and 16-02, similar to monitor parameters 12-5~12-83.

16- 03	Display unit			
Range	【0】 : Frequency display unit is Hz (Resolution is 0.01Hz) 【1】 : Frequency display unit is % (Resolution is 0.01%) 【2】 : Frequency display unit is RPM 【3~39】 : Reverse 【40~9999】 : 100% is XXXX with no decimals (integer only) 【10001~19999】 : 100% is XXX.X with 1 decimal 【20001~29999】 : 100% is XX.XX with 2 decimals 【30001~39999】 : 100% is X.XXX with 3 decimals			
16- 04	Engineering Unit			
Range	【0】 : No Unit 【1】 : FPM 【2】 : CFM 【3】 : PSI 【4】 : GPH 【5】 : GPM 【6】 : IN	【7】 : FT 【8】 : /s 【9】 : /m 【10】 : /h 【11】 : °F 【12】 : inW 【13】 : HP	【14】 : m/s 【15】 : MPM 【16】 : CMM 【17】 : W 【18】 : kW 【19】 : m 【20】 : °C	【21】 : RPM 【22】 : Bar 【23】 : Pa 【24】 : kPa

➤ **Display unit of digital operator (16-03)**

Set the units of the following items to be displayed, the frequency reference (05-01, 00-18, 06-01~06-15) and the monitoring frequency 12-16, 12-17 (Output frequency).

➤ **Display unit of engineering (16-04)**

When 16-03 = 00040-39999, engineering units are enabled. The displayed set range and the frequency range of unit (05-01, 06-01~06-15) as well as the monitoring frequency (12-16, 12-17) are changed by parameters 16-04 and 16-03.

16-03	Set / displayed contents			
0	0.01 Hz			
1	0.01 % (maximum output frequency 01-02=100%)			
2	Frequency display unit is RPM			
3- 39	Reserved			
00040 - 39999	Set the decimal point by using the fifth place i.e. <input type="text"/> <input type="text"/> <input type="text"/> <input type="text"/> <input type="text"/> 			
	00040 - 09999 : <input type="text"/> <input type="text"/> <input type="text"/> <input type="text"/> (Integer only e.g. 1000) 10001 - 19999 : <input type="text"/> <input type="text"/> <input type="text"/> . <input type="text"/> (1 decimal place e.g. 10.0) 20001 - 29999 : <input type="text"/> <input type="text"/> . <input type="text"/> <input type="text"/> (2 decimal places, e.g. 10.00) 30001 - 39999 : <input type="text"/> . <input type="text"/> <input type="text"/> <input type="text"/> (3 decimal places, e.g. 10.000)			
	<Example> :			
	16-03	Display	Display Unit	Display example
	00040-09999	<input type="text"/> <input type="text"/> <input type="text"/> <input type="text"/>	Use 16-04 Setting	<ul style="list-style-type: none"> ➤ 100 % speed is 0200 ● Set 16-03=00200 (from 05-01, 06-01 to 06-15, set range from 0040 to 9999). ● Set 16-04=0 (no unit)
10001-19999	<input type="text"/> <input type="text"/> <input type="text"/> . <input type="text"/>	<ul style="list-style-type: none"> ➤ 100 % speed is 200.0 CFM ● Set 16-03=12000 (05-01, 06-01 to 06-15, set range from 0000 to 9999). ● set 16-04=2 (CFM) ● 60% speed will be displayed as 120.0 CFM 		
20001-29999	<input type="text"/> <input type="text"/> . <input type="text"/> <input type="text"/>	<ul style="list-style-type: none"> ➤ 100 % speed is 65.00°C ● Set 16-03=26500 (05-01, 06-01 to 06-15, set range from 0000 to 9999) ● Set 16-04=20 (°C) ● 60% of speed is displayed as 39.00 °C 		
30001- 9999	<input type="text"/> . <input type="text"/> <input type="text"/> <input type="text"/>	<ul style="list-style-type: none"> ➤ 100 % speed is 2.555 m/s ● Set 16-03=32555 ● Set 16-04=14 (m/s) ● 60% speed is displayed as 1.533 m/s 		

16- 05	LCD Backlight
Range	【0~7】

- Adjust the screen contrast of the digital operator. If it is set to 0, the screen backlight is turned off.

16- 07	Copy Function Selection
Range	【0】 : Do not copy parameter 【1】 : Read inverter parameters and save to the keypad 【2】 : Write the keypad parameters to inverter 【3】 : Compare parameters of inverter and keypad
16- 08	Selection of allowing reading
Range	【0】 : Do not allow to read inverter parameters and save to the keypad 【1】 : Allow to read inverter parameters and save to the keypad

➤ **LCD digital operator can be used to store and retrieve parameters**

- (1) Read : Save inverter parameters to the digital operator (INV → OP).
- (2) Write : Write the parameters from the digital operator to the inverter (OP → INV)
- (3) Verify : Compare the inverter parameters with the parameters in the digital operator.

➤ **16-07= 0 : No action**

- (1) 16-07= 1 : Read (all parameters are copied from the inverter to the keypad)
- (2) 16-07= 2 : Write (all parameter are copied from the keypad to the inverter)
- (3) 16-07= 3 : Verify (Compare the set value to the parameter of the digital operator)





➤ **Set 16-08=0**

In order to prevent the saved parameter data stored in the digital operator from accidentally being overwritten. When parameter 16-08=0 and the read operation is executed (16-07=1) a warning message of "RDP Read Prohibited" will be displayed on the keypad and the read operation is cancelled.

➤ **For the write-in operation requires the following items to match.**

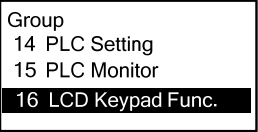
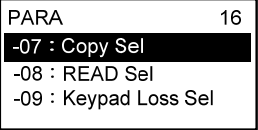
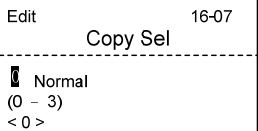
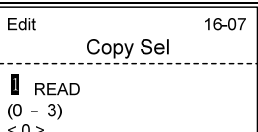
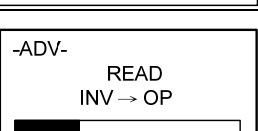
- (1) Inverter type
- (2) Inverter rated capacity and voltage



➤ READ : Copy inverter parameters to the keypad

Steps	LCD Display (English)	Description
1		Select the copy function group (16) from the group menu.
2		Press the Read / Enter key and select parameter (16-07) copy selection.
3		Press the Read / Enter key to display the data setting / read screen (LCD display is inversed).
4		Change the set value to 1 (read) by using the up arrow key.
5		<p>(1) Use Read / Enter key to enable the read operation, the display is shown as the left.</p> <p>(2) The bottom of LCD display will show a bar to indicate the read progress.</p>
6		(3) "READ COMPLETE" will be displayed on the keypad when reading was successful.
		<p>(1) The error message of "RDP Read Prohibited" may occur on the keypad when reading parameters from the inverter is prohibited.</p> <p>(2) If the error is displayed, press any key to remove the error message and go back to parameter 16-07.</p>
7		When DSP/FUN key is pressed, the display returns to parameter 16-07.

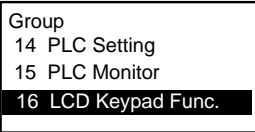
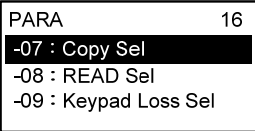
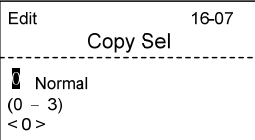
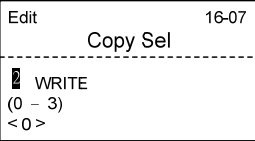
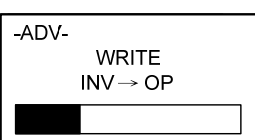
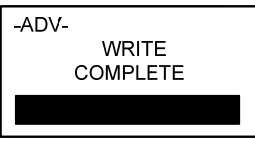
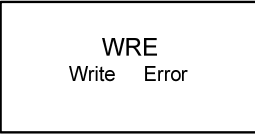
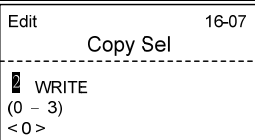
WRITE : Copy Keypad parameters to the Inverter

Steps	LCD Display (English)	Description
1		Select the copy function group (16) from the group menu.
2		Press the Read / Enter key and select parameter (16-07) copy sel.
3		Press the Read / Enter key to display the data setting / read screen (LCD display is inverted).
4		Change the set value to 2 (write) by using the up arrow key.
5		<p>(1) Use Read / Enter key to enable the read operation, the display is shown as the left.</p> <p>(2) The bottom of LCD display will show a bar to indicate the read progress.</p>
6		<p>“WRITE COMPLETE” will be displayed on the keypad when writing was successful. Inverter will show “WRITE SysInit” after 3 seconds, please re-power again, inverter will start to download the parameters.</p> <ul style="list-style-type: none"> ➤ The error message of “WRE Write Error” may occur on the keypad when writing parameters to the inverter is prohibited. ➤ If the error is displayed, press any key to remove the error message and go back to parameter 16-07.
		
7		When DSP/FUN key is pressed, the display returns to parameter 16-07.

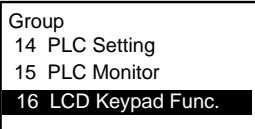
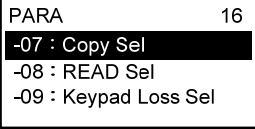
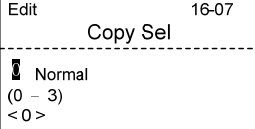
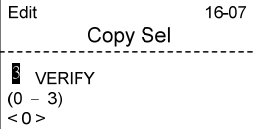
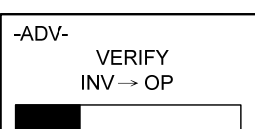
➤ Verify : Compare Inverter Parameters against Keypad Parameters

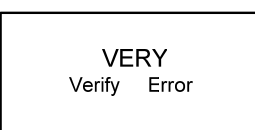
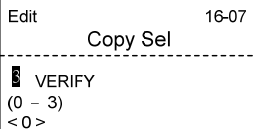
Steps	LCD Display (English)	Description
1		➤ Select the copy function group (16) from the group menu.
2		➤ Press the Read / Enter key and select parameter (16-07) copy sel.
3		➤ Press the Read / Enter key to display the data setting / read screen (LCD display is inversed).
4		➤ Change the set value to 3 (verify) by using the up arrow key.
5		(1) Use Read / Enter key to enable the read operation, the display is shown as the left. (2) The bottom of LCD display will show a bar to indicate the read progress.
6		(3) “VERIFY COMPLETE” will be displayed on the keypad when writing was successful.
		(3) The error message of “VRYE Verify Error” may occur on the keypad when writing parameters to the inverter is prohibited. (4) If the error is displayed, press any key to remove the error message and go back to parameter 16-07.
7		➤ When DSP/FUN key is pressed, the display returns to parameter 16-07.

16- 09	Selection of keypad removed (LCD)
Range	【0】 : Keep operating when LCD keypad is removed 【1】 : Display fault when LCD keypad is removed

If 00-02=0, this parameter will decide whether inverter stops after digital operator removed.

Group 17 Automatic Tuning Parameters

17- 00	Mode selection of automatic tuning
Range	【0】 : Rotational auto-tuning 【1】 : Static auto-tuning 【2】 : Stator resistance measurement 【3】 : Reserved 【4】 : Loop tuning 【5】 : Rotational Auto-tuning Combination (Item: 4+2+0) 【6】 : Static Auto-tuning Combination (Item: 4+2+1)
17- 01	Motor rated output power
Range	【0.00~600.00】 kW
17- 02	Motor rated current
Range	VF mode : 10%~120% of the inverter rated current SLV mode : 25%~120% of the inverter rated current
17- 03	Motor rated voltage
Range	200V : 【50.0~240.0】 V 400V : 【100.0~480.0】 V
17- 04	Motor rated frequency
Range	【4.8~599.00】 Hz
17- 05	Motor rated speed
Range	【0~24000】 RPM
17- 06	Pole number of motor
Range	【2~16】 pole
17- 08	Motor no-load voltage
Range	200V : 【50~240】 V 400V : 【100~480】 V
17- 09	Motor excitation current
Range	【15~70】 % of motor rated current
17- 10	Automatic tuning start
Range	【0】 : Disable 【1】 : Enable
17- 12	Proportion of Motor Leakage Inductance
Range	【0.1~15.0】 %
17- 13	Motor Slip Frequency
Range	【0.10~20.00】 Hz
17- 14	Rotational Auto-tuning
Range	【0】 : VF type rotational auto-tuning 【1】 : Vector type rotational auto-tuning

- (1) Values are for 200V class, double the values for 400V class
- (2) In HD mode (00-27=0) the range is 0.0 to 400.0 Hz, 0.0 to 120.0Hz in for ND mode (00-27=1) and 0.0 to 599.0Hz is high frequency mode.
- (3) Based on the motor nameplate set the motor rated output power (17-01), motor output rated current (17-02), motor rated voltage (17-03), motor rated frequency (17-04), motor rated speed (17-05) and number of motor poles (17-06) to perform an auto-tune.

➤ **Rotational auto-tuning (17-00=0)**

Inverter can provide higher quality for motors. After executing Rotational auto-tuning (17-00), Excitation current of motor 1 (02-09) · Core saturation coefficient 1 of motor 1(02-10) · Core saturation coefficient 2 of motor 1 and Core saturation coefficient 3 of motor 1 (02-12) will renew the value.

➤ **Static auto-tuning (17-00=1)**

Static auto-tuning won't rotate the motor while auto-tuning. After executing Static auto-tuning (17-00=1), Proportion of motor leakage inductance (02-33) and Motor slip (02-34) will renew the value.

➤ **Stator resistance measurement (17-00=2)**

Stator resistance measurement provides for long motor length (exceed 50 meters). After executing Stator resistance measurement (17-00=2), Resistance between wires of motor 1(02-15) will renew the value.

➤ **Loop tuning (17-00=4)**

Loop tuning (17-00=4) provide great response of current circuit, it can improve frequency bandwidth of current and torque.

➤ **Rotation Auto-tuning Combination (17-00=5)**

Rotation Auto-tuning Combination is the auto-tuning for three in one, including Loop tuning (17-00=4), Stator resistance measurement (17-00=2) and Rotational auto-tuning (17-00=0).

➤ **Static Auto-tune Combination (17-00=6)**

Static Auto-tune Combination (17-00=6) is the auto-tuning for three in one, including Loop tuning (17-00=4) · Stator resistance measurement (17-00=2) and Static auto-tuning (17-00=1)

➤ **Motor rated output power (17-01)**

Set by inverter capacity (13-00) according to the nameplate of motor.

➤ **Motor rated current (17-02)**

- (1) Set by inverter capacity (13-00) according to the nameplate of motor.
- (2) In V/F mode, set the range to 10~120 % of the inverter rated current.
- (3) In SLV mode, set the range to 25~120% of the inverter rated current.

➤ **Motor rated voltage (17-03)**

Prevent the inverter output voltage from saturation when the motor rated voltage is higher than the inverter input voltage (see Example 1).

➤ **Motor rated frequency (17-04)**

Please set the value according to motor nameplate

➤ **Motor rated speed (17-05)**

Please set the value according to motor nameplate

➤ **Number of poles (17-06)**

Set the motor pole number with its range is 2~16 poles. (even)

➤ **Motor no-load voltage (17-08)**

- (1) Motor no-load voltage is mainly used in SLV mode, set to value 10~50V lower than the input voltage to ensure good torque performance at the motor rated frequency.
- (2) When 17-08 set to 85~95% of the motor rated voltage. In general, the no-load voltage can be closer to the motor rated voltage for larger motors, but cannot exceed the motor rated voltage.
- (3) The motor no-load voltage can be set to a value greater than the actual input voltage. In this case, the motor can only operate under relatively low frequency. If the motor operates at the rated frequency an over voltage condition may occur.
- (4) The higher the motor power is, the higher the no-load voltage is.
- (5) A smaller no-load voltage will reduce the no-load current. When load is applied the magnetic flux is weakened and the motor current increases.
- (6) A higher no-load voltage results in a higher the no-load current. When load is applied the magnetic flux weakens and the motor current increases. Increasing the magnetic flux generates back EMF and results in poor torque control.

➤ **Motor excitation current (17-09)**

- (1) Only the static-type or stator resistance measurement auto-tune (17-00=1 or 2) can be set.
- (2) Motor excitation current is used for rotational auto-tune.
- (3) Set motor excitation current to 33% of the motor rated current. During auto-tune the keypad will display "Atune" for Auto-tune in progress. When the motor is successfully tuned, the keypad shows "AtEnd".

➤ **Error history of automatic tuning (17-11)**

- (1) If auto-tuning fails the keypad will display the "AtErr" message and the auto-tune cause is shown in parameter 17-11.
- (2) Refer to section 5 for troubleshooting and possible automatic tuning error causes.

Note :

The motor tuning error history (17-11) shows the tuning result of the last auto-tune. No error is displayed when auto-tune is aborted or when the last auto-tune was successful.

➤ **Proportion of Motor Leakage Inductance (17-12)**

- (1) Only the stator resistance auto tune (17-00=2) can be set.
- (2) The static non-rotational type and rotational type auto tune will automatically measure the proportion of motor leakage inductance so this parameter is not active.
- (3) It is set the value to 4%. Refer to parameter 02-33 for test run to adjust.

➤ **Motor Slip Frequency (17-13)**

- (1) Only the stator resistance auto tune (17-00=2) can be set.
- (2) The static non-rotational type and rotational type auto tune will automatically measure the proportion of motor leakage inductance so this parameter is not active.
- (3) Refer to parameter 02-34 for counting the setting value.

Example 1 :

Motor rated voltage (440V/60Hz) is higher than the inverter input voltage (380V/50 Hz).

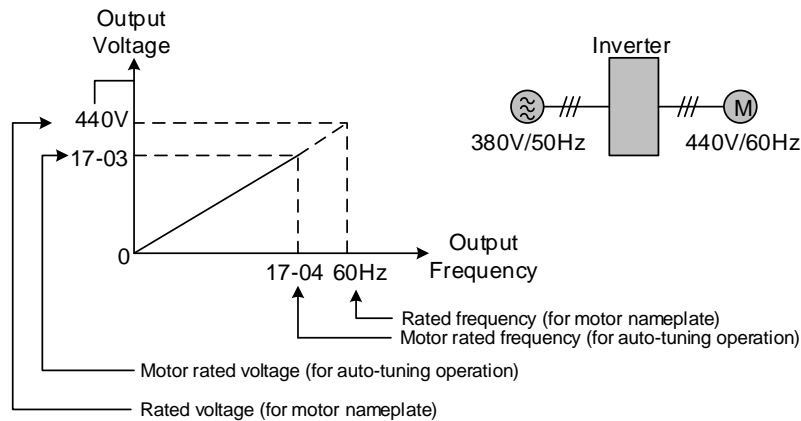

Figure 4.3.98 Rated voltage and frequency settings

- Step 1 : Set auto-tuning (17-00), and set motor rated output power (17-01) and the motor rated current (17-02) by label of the motor.
- Step 2 : Set the value of motor rated voltage (17-03) =440V by label of the motor.
- Step 3 : Set the value of motor rated frequency (17-04) =60Hz
- Step 4 : Set the value of motor rated speed (17-05) 、 pole number of motor (17-06)
- Step 5 : Set the value of motor no-load voltage (17-08) =360V, the set value for torque control is 20V lower than input voltage.
- Step 6 : Execute auto-tuning. Set auto-tuning (17-10=1) and enter to standby screen. Enter RUN command to start auto-tuning. The value of motor rated frequency (17-04) adjusts automatically to the same as the value of base frequency of motor 1. If the value of maximum output frequency of motor 1 (01-02) is different from base frequency of motor 1 (01-12), the system will adjust the value of maximum output frequency of motor 1 (01-02) the same as base frequency of motor 1 (01-12) automatically.

- When the inverter input voltage (or frequency) is higher than the motor rated voltage (or frequency), set the motor rated voltage (17-03) and the motor rated frequency (17-04) to the rated frequency on the motor nameplate.

Example 2 :

The inverter input voltage and frequency (460V/50Hz) are higher than the motor rated voltage and frequency (380V/33Hz), set 17-03 to 380V (rated motor voltage) and 17-04 to 33Hz (motor rated frequency).

➤ Rotational Auto-tuning (17-14)

- (1) The parameter can be set (17-14) only when rotational auto-tuning (17-00=0) or Rotational auto-tuning combination (17-00=5).

- (2) VF type rotational auto-tuning (17-14=0) applies the standard IM motor that won't shake without loading for V/F mode. This function is highly applicable.
- (3) Vector type rotational auto-tuning (17-14=1) applies the special IM motor that will shake without loading for V/F mode. This function applies for high speed motor. If execute VF type rotational auto-tuning (17-14=0) unsuccessfully, try Vector type rotational auto-tuning (17-14=1) again.
- (4) Vector type rotational auto-tuning (17-14=1) measures no-loading current of motor by inner current vector method. It avoid the problem appears oscillating current easily in V/F mode.

Group 18 Slip Compensation Parameters

18- 00	Slip compensation gain at low speed
Range	【0.00~2.50】
18- 01	Slip compensation gain at high speed
Range	【-1.00~1.00】
18- 02	Slip compensation limit
Range	【0~250】 %
18- 03	Slip compensation filter
Range	【0.0~10.0】 Sec
18- 04	Regenerating slip compensation selection
Range	【0】 : Disable 【1】 : Enable
18- 05	FOC delay time
Range	【1~1000】 mSec
18- 06	FOC gain
Range	【0.00~2.00】

- The slip compensation function compensates for the motor slip to match the actual motor speed to the reference frequency
- Slip compensation automatically adjusts the output frequency based on the motor load to improve the speed accuracy of the motor mainly in V/F mode.

Slip compensation adjustment in V/F mode

➤ Slip compensation gain at low speed (18-00)

The default setting of 18-00 is "0.0", when 18-00=0, the slip compensation function is disabled.

The adjustment of slip compensation gain at low speed follows the below procedure :

- (1) Set the rated slip and the motor no-load current (02-00)
- (2) Set the slip compensation (18-00) to 1.0 (factory default setting is 0.0 in V / F control mode)
- (3) For the operation with a load attached, measure the speed and adjust the slip gain (18-00) accordingly (increase in steps of 0.1)
 - ✓ If the motor speed is lower than frequency reference, increase the value of 18-00
 - ✓ If the motor speed is higher than frequency reference, decrease the value of 18-00

When the output current(12-18) is greater than the no-load current(02-00), the slip compensation is enabled and then output frequency increase from f1 to f2. Refer to figure 4.3.99, the slip compensation value is calculated as follows :

$$\text{Slip Compensation Value} = \text{Motor rated slip frequency} \times \frac{[\text{Output current (12-18)} - \text{no-load current of Motor 1 (02-00)}]}{[\text{Rated current of Motor 1(02-01)} - \text{no-load current of Motor 1 (02-00)}]}$$

$$\text{Motor Rated Slip Frequency (f)} = \frac{(\text{Motor no-load synchronous speed} - \text{Motor full load rated speed})(N) \times \text{Motor Poles (P)}}{120}$$

120

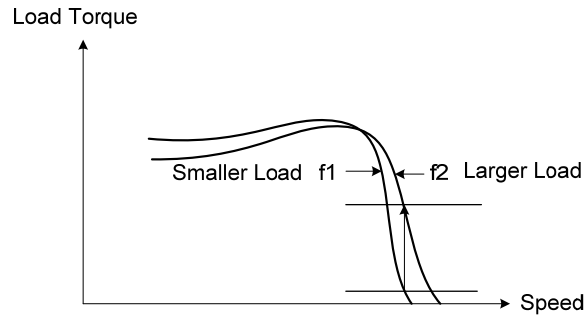

Figure 4.3.99 Slip compensation output frequency

➤ **Slip compensation gain at high speed (18-01)**

- (1) It is not required to adjust the Slip compensation gain at high speed if the motor is loaded.
- (2) After adjusting parameter 18-00 it is recommended to increase the reference frequency and check the motor speed. In case of a speed error increase the value of 18-01 to adjust the compensation.
- (3) Increase the motor rated frequency (01-12 base frequency) and increase the value of 18-01 to reduce the speed error.
- (4) Compared to 18-00, 18-01 serves as a variable gain for the full speed range.
- (5) If the speed accuracy becomes worse due to an increase in motor temperature it is recommended to use a combination of 18-00 and 18-01 for adjustment.

Parameter 18-01 determines the slip compensation at the motor rated speed and is calculated follows :

$$\text{Slip Compensation Gain} = (\text{Slip Compensation Gain at low speed} + \text{Slip Compensation Gain at high speed}) \times \frac{\text{Reference Frequency}}{\text{Motor rated frequency (01-12)}}$$

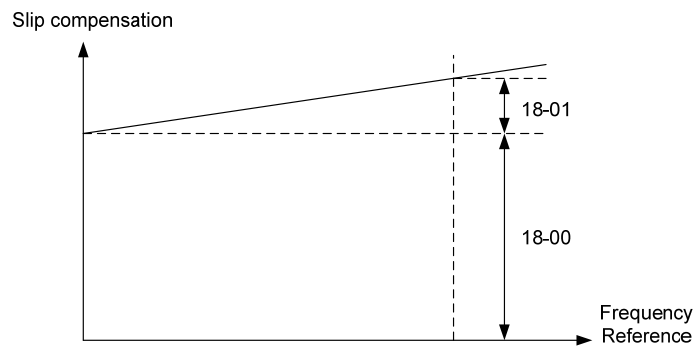

Figure 4.3.102 18-00/18-01 Slip compensation gain versus frequency reference

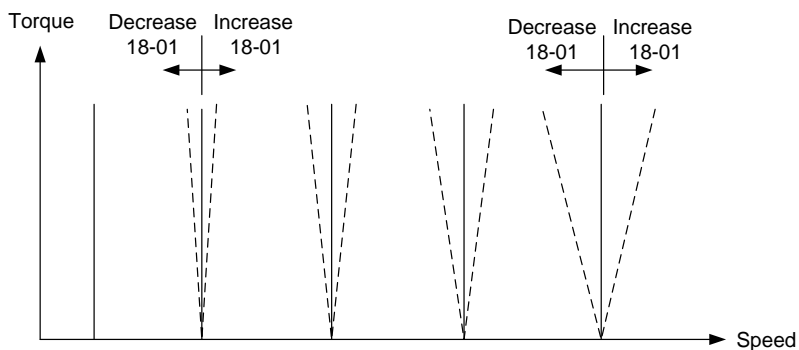

Figure 4.3.103 18-01 Effect on torque speed curve

➤ **Slip compensation limit (18-02)**

- (1) Sets slip compensation limit in constant torque and the constant power operation (Figure 4.3.100)
- (2) When 18-02 is 0%, the slip compensation limit is disabled.

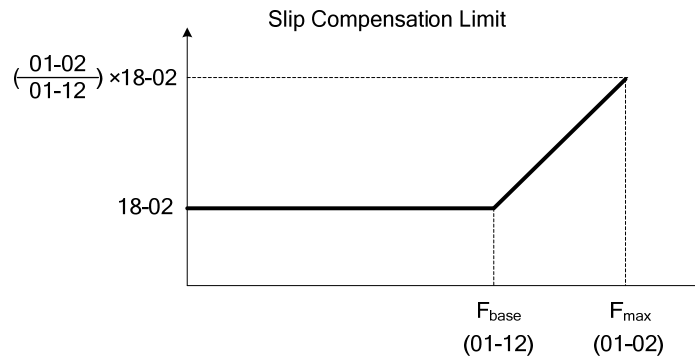

Figure 4.3.100 Slip compensation limit

When the slip compensation gain 18-00 at low speed is adjusted, and the actual motor speed is still lower than the reference frequency, the motor may be limited by the slip compensation limit.

➤ **Slip compensation filter (18-03)**

Set slip compensation filter time in V/F mode

➤ **Regenerating slip compensation selection (18-04)**

- (1) Slip compensation selection enable or disable during regeneration period.
- (2) To enable slip compensation during regeneration caused by deceleration (SLV mode), set 18-04 to 1 in case speed accuracy is required.
- (3) When the slip compensation function is used regenerative energy might increase temporarily (18-04= 1) therefore a braking module might be required.

SLV mode adjustment

➤ **Slip compensation gain**

- (1) Slip compensation can be used to control the full range speed accuracy under load condition.
- (2) If the speed is lower than 2 Hz and the motor speed decreases, increase the value of 18-00.
- (3) If the speed is lower than 2 Hz and the motor speed increases, reduce the value of 18-00.

Slip compensation gain uses a single value for the whole speed range. As a result the slip compensation accuracy at low speed is high but slight inaccuracies might occur at high speeds.

For the speed control accuracy of full range, 18-00 is a fixed value. If inverter adjust speed accuracy at lower speed, speed accuracy will also be happened at higher speed. If the speed accuracy at higher speed is not acceptable, please adjust 18-00 or 18-01, but adjusting these parameters might impact the accuracy at lower speeds.

The impact of 18-00 on the torque and the speed are shown in figure 4.3.101

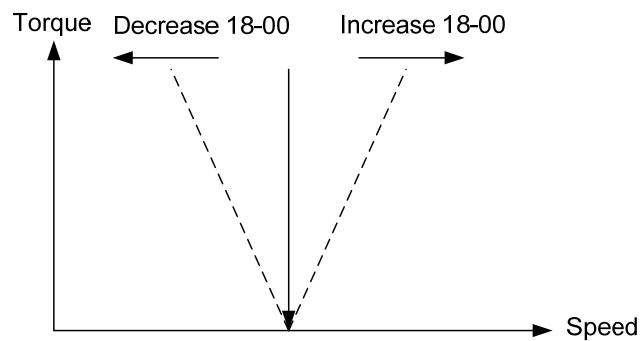

Figure 4.3.101 18-00 Effect on the torque and speed

➤ **FOC (Flux Orient Control) delay time (18-05)**

- (1) In the SLV mode, the slip compensation of the magnetic flux depends on the torque current and excitation current.
- (2) If the motor load rises above 100% while running at the motor rated frequency, the motor voltage and resistance drops sharply, which may cause the inverter output to saturate and current jitter occur.
- (3) The magnetic flux slip compensation will independently control the torque current and the excitation current to prevent current jitter.
- (4) For slow speed or fixed speed operation, 18-05 may be increased. For fast operation adjust 18-06.

➤ **Slip compensation gain (18-06)**

If the motor is jittering at the rated frequency under full load, the value of 18-06 may gradually be reduced to zero to reduce current jitter.

Group 20 Speed Control Parameters

20- 00	ASR gain 1
Range	【0.00~250.00】
20- 01	ASR integral time 1
Range	【0.001~10.000】 Sec
20- 02	ASR gain 2
Range	【0.00~250.00】
20- 03	ASR integral time 2
Range	【0.001~10.000】 Sec
20- 04	ASR integral time limit
Range	【0~300】 %
20- 07	Selection of acceleration and deceleration of P/PI
Range	<p>【0】 : PI speed control will be enabled only in constant speed. For the speed acceleration and deceleration, only use P control.</p> <p>【1】 : Speed control is enabled either in acceleration or deceleration.</p>
20- 08	ASR delay time
Range	【0.000~0.500】 Sec
20- 09	Speed Observer Proportional(P) Gain1
Range	【0.00~2.55】
20- 10	Speed Observer Integral(I) Time 1
Range	【0.01~10.00】 Sec
20- 11	Speed Observer Proportional(P) Gain2
Range	【0.00~2.55】
20- 12	Speed Observer Integral(I) Time 2
Range	【0.01~10.00】 Sec
20- 13	Low-pass filter Time constant of speed feedback 1
Range	【1~1000】 mSec
20- 14	Low-pass filter Time constant of speed feedback 2
Range	【1~1000】 mSec
20- 15	ASR gain change frequency 1
Range	【0.0~599.0】 Hz
20- 16	ASR gain change frequency 2
Range	【0.0~599.0】 Hz
20- 17	Torque compensation gain at low speed
Range	【0.00~2.50】
20- 18	Torque compensation gain at high speed
Range	【-10~10】 %
20-33	Detection Level at Constant Speed
Range	【0.1~5.0】 %

Parameter 20-33 is used when 20-07 is set to 0 and frequency command source is set to analog input mode. Analog input signal, owing to the noise, will cause the system to determine the operation does not reach the constant speed so the problem may occur. Thus, adjust parameter 20-33 to avoid this situation occurring.

➤ The following figure an overview of the automatic speed regulator (ASR) block.

SLV control mode :

- (1) The ASR function adjusts the output frequency to control the motor speed to minimize the difference between the frequency reference and actual motor speed.
- (2) The ASR controller in SLV mode uses a speed estimator to estimate the motor speed. In order to reduce speed feedback signal interference, a low-pass filter and speed feedback compensator can be enabled.
- (3) The ASR integrator output can be disabled or limited. (03-00 to 03-05= 43). The ASR output is passed through a low-pass filter.

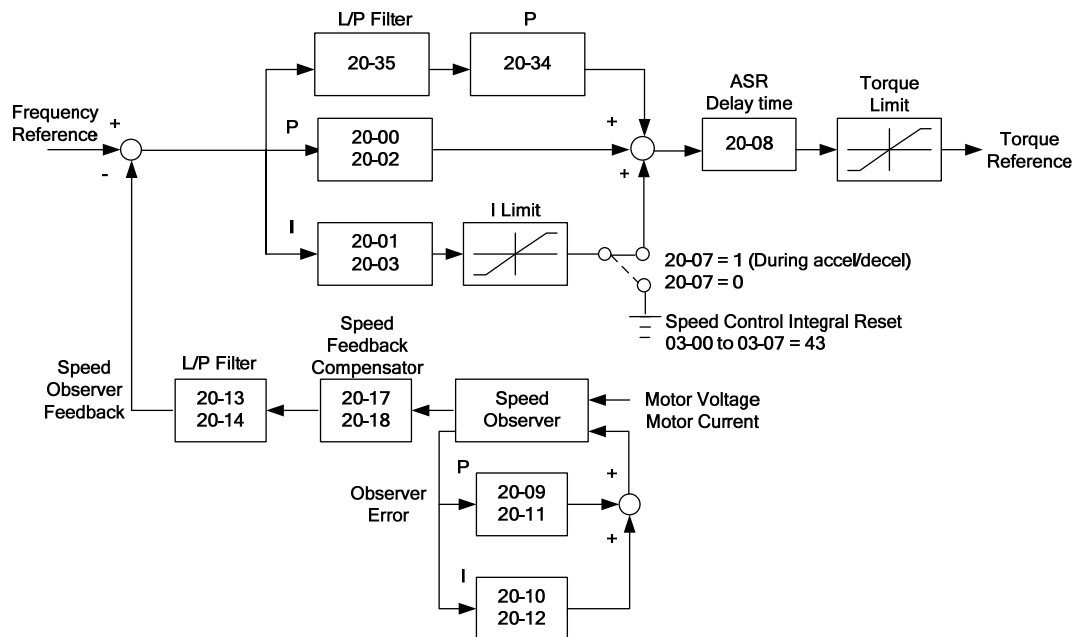

Figure 4.3.108 ASR speed control diagram (SLV mode)

ASR Setting (SLV/PMSLV control mode)

- (1) In SLV mode the ASR gain is divided into a high-speed and low-speed section. The speed controller has a high-speed gain 20-00/20-01 and a low-speed gain 20-02/20-03 that can be set independently. The switch between the high-speed and the low-speed is set by parameter 20-15 and 20-16.
- (2) The high/low switch frequency can be set with parameter 20-15 and 20-16. Similar to the ASR gain, the speed estimator has a high-speed gain 20-09/20-10 and a low-speed gain 20-11/20-12.
- (3) The speed estimator has a low-pass filter to reduce the speed feedback interference, parameter 20-13 and 20-14 are active at high speed as well as low speed. The switch between the high-speed and the low-speed is set by parameter 20-15 and 20-16.
- (4) 20-17 sets the low-speed compensation gain of the speed feedback.
- (5) 20-18 sets the high-speed compensation gain of the speed feedback.
- (6) When the frequency reference is rises above the value set in 20-16, the ASR gain used is set by parameters 20-00 and 20-01. When the frequency reference falls below the value set in 20-15, the ASR gain used is set by parameters 20-02 and 20-03. Gain time constant is adjusted linearly when the speed command falls within the range of 20-15 to 20-16, for a smooth operation.

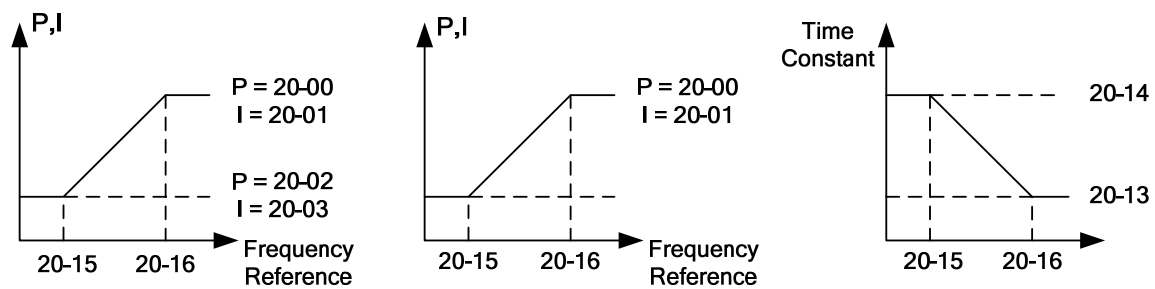

Figure 4.3.112 ASR gain setting (SLV mode)

➤ **Tune the speed control gain**

During ASR gain tuning, the multi-function analog output (AO1 terminal) can be used to monitor the output frequency and motor speed (as shown in figure 4.3.112) .

➤ **SLV mode gain tuning (20-00~20-03 , 20-09~20-18)**

- (1) Tune the low-speed ASR P and I gain 20-02 ~ 20-03, make sure the reference frequency is below the value of parameter 20-15.
- (2) Tune the high-speed ASR PI gain 20-00~20-01, make sure the reference frequency is above parameter 20-16 value.
- (3) Both low-speed ASR gain and the high-speed gain can be set to the same values and only require to be adjusted in case of system instability.
- (4) In case tuning of the ASR P and I gain 20-00~20-03 does not improve the system response, reduce the low-pass filter time constant 20-13~20-14 to decrease the bandwidth of the feedback system and re-tune the ASR gain.
- (5) Tune low-speed low-pass filter time constant 20-14, make sure the reference frequency is below parameter 20-15 value.
- (6) Tune high-speed low-pass filter time constant 20-13 at frequency reference, make sure the reference frequency is above parameter 20-16 value.
- (7) Increasing the low-pass filter time constant can limit the bandwidth of the speed feedback system and may reduce the system response. Increasing the low-pass time reduces the speed feedback signal interference but may results in sluggish system response when the load suddenly changes. Adjust the low-pass filter time if the load stays fairly constant during normal operation. The low bandwidth of the speed feedback must be supported by the low gain of ASR to ensure the stable operation.
- (8) Decreasing the low-pass filter time constant may increase the bandwidth of the speed feedback and the system response. Decreasing the low-pass time may increase the speed feedback interference resulting in system instability when the load suddenly changes. Decrease the low-pass filter time is a quick system response is required for rapidly changing loads. The high bandwidth of the speed feedback allows for a relative high ASR gain.
- (9) In case tuning 20-00~20-03 and the low-pass filter time constant 20-13~20-14 do not improve the system response time, tuning the PI gain 20-09~20-12 of the speed estimator may be required.
- (10) Setting a high gain for the speed estimator (high proportion (P) gain and small integral (I)time) increases the bandwidth of the speed feedback, but may cause speed feedback interference resulting in system instability.

- (11) Setting a low gain for the speed estimator (small proportion (P) gain and high integral (I) time) decreases the bandwidth of the speed feedback, may improve speed feedback interference resulting in a more stable system.
- (12) The default values for the ASR can be used in most applications, no adjustment is required. Adjusting the low-pass filter time and speed estimator gains requires a good understanding of the overall system. If a high-speed system response in combination with stable operation is required consider using SLV control mode.
- (13) Parameter 20-15 sets the gain switch frequency at low-speed and parameter 20-16 sets the gain switch frequency at high-speed.
- (14) Operating at a speed below 20-15 will result in a larger excitation current for low-speed operation accuracy. When the frequency reference rises above 20-16, the inverter will output the rated excitation current at the no-load voltage (02-19).
- (15) For general purpose applications parameter 20-15 should be set to a value of 5~50% of the motor base frequency. If this value is too high, the inverter output may saturate. Parameter 20-16 should be set to a value of 4Hz or more above the value of 20-08.
- (16) When experiencing speed jitter at high speed and stable operation during mid-range speed while operating a heavy load (>100%), it is recommended to reduce the no-load voltage (02-19) or tune the FOC parameters (18-05 ~ 18-06).
- (17) Parameter 20-17 and 20-18 are for compensating speed feedback at low speed and high speed.
- (18) Use parameter 20-17 to adjust the torque compensation gain for the low speed range. By tuning 20-17 an offset is added to the torque-speed curve. Increase 20-17 when the no-load speed is lower than the frequency reference. Decrease 20-17 when the no-load speed is higher than the frequency reference.

The effect on the torque-speed curve from 20-17 is shown as the following figure

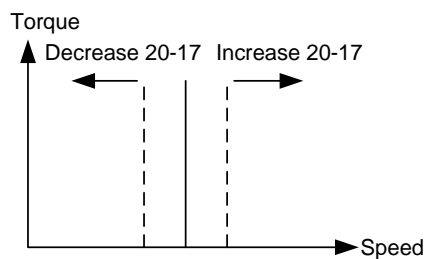

Figure 4.3.115 20-17 Effect on the torque-speed curve from

Use parameter 20-18 to adjust the torque compensation gain for middle to high speed range. For most general purpose applications it is not necessary to adjust the 20-18. The effect on the torque-speed curve from 20-18 is shown as the following figure 4.3.116.

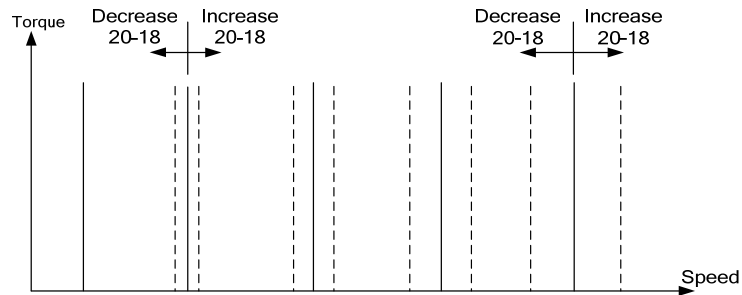

Figure 4.3.116 Effect on the torque-speed curve from 20-18

➤ **ASR integral limit (20-04)**

Setting a small value may prevent system response when the load suddenly changes.

➤ **ASR main delay time (20-08).**

- (1) Does not require to be adjusted for general purpose applications.
- (2) When the set value of 20-08 is set high, the speed response will be reduced, but the system is more stable.

20- 34	Compensation Gain of Derating
Range	【 0 ~25600 】
20- 35	Compensation Time of Derating
Range	【 0~30000 】 mSec

Refer to Fig.4.3.108 and Fig. 4.3.109. Torque compensation function of derating can reduce the characteristics of ASR turning around under shock load.

- This gain effect is the same as ASR proportional gain (20-00, 20-02). And if this parameter is coupled with low-pass filter time constant (20-35), it can avoid oscillation.
- This time constant is used for suppressing the oscillation produced by 20-34. But too large compensation time constant will cause slower output response and then is unfavorable for turned compensation.
- It is suggested that the setting value of parameter 20-34 is 30~50ms and 20-35 is 50~100ms.

Group 21 Torque Limit Parameters

21- 05	Positive torque limit
Range	【0~300】 %
21- 06	Negative torque limit
Range	【0~300】 %
21- 07	Forward regenerating torque limit
Range	【0~300】 %
21- 08	Reversal regenerating torque limit
Range	【0~300】 %

- In SLV and PMSLV control mode, there are four torque limits that can be set separately :
- I. Positive torque limit in forward direction (21-05 positive torque limit)
 - II. Positive torque limit of reverse direction (21-06 negative torque limit)
 - III. Negative torque limit in reverse direction (21-07 forward regenerating torque limit)
 - IV. Negative torque limit in forward direction (21-08 reversal regenerating torque limit)

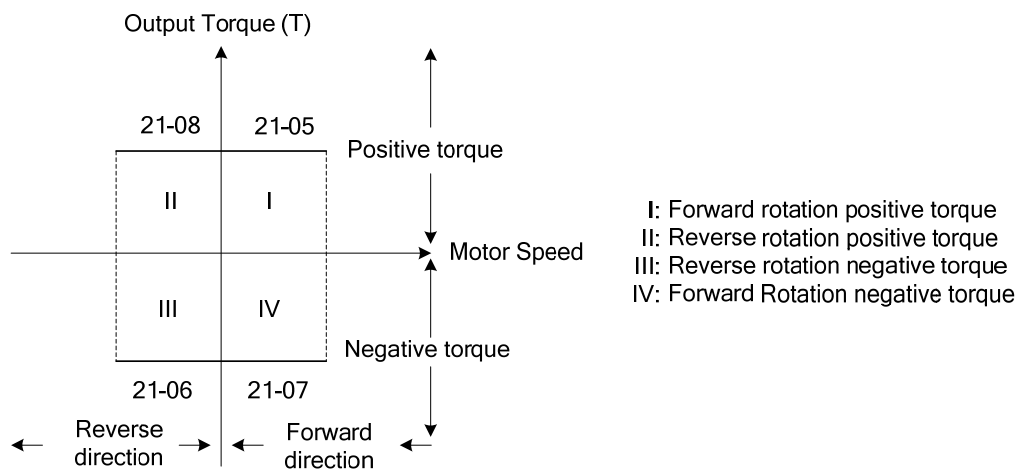

Figure 4.3.117 Torque limit setting

Group 22 PM Motor Parameters

22- 00	PM Motor Rated Power
Range	【0.00~600.00】 kW
22- 02	PM Motor Rated Current
Range	25%~200% inverter's rated current
22- 03	PM Motor's Pole Number
Range	【2~96】 Poles
22- 04	PM Motor's Rated Rotation Speed
Range	【0~60000】 RPM
22- 05	PM Motor's Maximum Rotation Speed
Range	【0~60000】 RPM
22- 06	PM Motor Rated Frequency
Range	【4.8~599.0】 Hz
22-07	PM type selection
Range	【0】 SPM 【1】 IPM

- The PM parameter group can be restored to factory setting (13-08), please confirm the motor rating before initializing the inverter (13-00).

(1) PM motor rated power (22-00)

Set the motor power according to the motor nameplate.

(2) PM motor rated current (22-02)

Set the motor full load according to the motor nameplate.

(3) PM motor pole number (22-03).

Set the number of motor poles according to the motor nameplate.

(4) PM motor rated speed (22-04)

Set parameter 22-04 or 22-06, the inverter will automatically calculate the one or the other. Set the motor rated speed in rpm according to the motor nameplate.

$$(\text{PM motor rated speed}) N = \frac{120 \times f (\text{PM motor rated frequency})}{P (\text{PM motor pole number})}$$

(5) PM motor maximum rotation speed (22-05)

When using the flux-weakening function, the PM motor's maximum rotation speed (22-05) must be set higher than the PM motor's rated rotation speed (22-04).

(6) PM motor rated frequency (22-06)

Set the motor rated frequency according to the motor nameplate.

(7) PM type selection (22-07)

When using the SPM motor, the recommended setting is 0. Related adjustable parameters are the

speed estimated gain (22-30) and the speed estimated filter value (22-31).

When using the IPM motor, the recommended setting is 1. Related adjustable parameters are the speed estimated gain (22-34) and the speed estimated filter value (22-35).

22- 10	PM SLV Start Current
Range	【20.0 ~ 200.0】 %
22- 11	I/F Mode Start Frequency Switching Point
Range	【1.0 ~ 20.0】 %
22- 14	Armature Resistance of PM Motor
Range	【0.001 ~ 30.000】 Ω
22- 15	D-axis Inductance of PM Motor
Range	【0.01 ~ 300.00】 mH
22- 16	Q-axis Inductance of PM Motor
Range	【0.01 ~ 300.00】 mH
22-18	Flux-Weakening Limit
Range	【0 ~ 100】 %
22- 21	PM motor tuning
Range	【0】 : PM Motor Tuning is not Active 【1】 : Parameter Auto-tune Mode 1 【2】 : Parameter Auto-tune Mode 2
22- 22	Fault History of PM Motor Tuning
Range	【0】 : None 【1】 : Static Magnetic Alignment Fault 【5】 : Loop Adjustment is Time Out 【7】 : Other Errors of Motor Tuning 【9】 : Current Abnormity Occurs when Loop Adjustment
22- 23	PM SLV acceleration time
Range	【0.1~10.00】 Sec
22- 25	Detection Mode Selection of Initial Magnetic Pole
Range	【0】 : Disable 【1】 : Detection Mode 1 【2】 : Detection Mode 2
22-26	Estimator Mode
Range	0~1 (in PMSLV mode)
22-27	Voltage Command of Mode 2
Range	【5 ~ 120】 % (22-25=2 or 22-26=1 is enabled)
22-28	Divider Ratio of Mode 2
Range	【0~8】 (22-25=2 or 22-26=1 is enabled)
22-29	Flux-weakening Voltage Command Restriction
Range	【80 ~ 110】 % (related to parameter 22-18)
22-34	IPM Estimator Gain
Range	【1 ~ 180】 %

(8) PMSLV Start Current (22-10)

Set torque current at start and the unit is the percentage of motor rated current.

(9) I/F Mode Start Frequency Switching Point (22-11)

This function is for the switching point from open-loop to close-loop in PMSLV mode. The unit is

percentage for rated speed of motor. It recommends that over 5% for 400V and over 10% for 200V.

(10) Armature Resistance of PM Motor (22-14)

Set resistor for each phase of the motor in unit of 0.001Ω . It is set automatically when the motor auto-tunes (22-21).

(11) D-axis Inductance of PM Motor (22-15)

Set motor's D-axis inductance in unit of 0.001mH . It is set automatically when the motor auto-tunes (22-21).

(12) Q-axis Inductance of PM Motor (22-16)

Set motor's Q-axis Inductance in unit of 0.001mH . It is set automatically when the motor auto-tunes (22-21).

(13) Flux-Weakening Limit (22-18)

If the motor's maximum rotation speed (22-05) is set to be higher than the motor's rated rotation speed (22-04), it will automatically start the flux-weakening control. It is set to limit the maximum flux-weakening energy and the unit is the percentage of motor rated current.

(14) PM Motor Tuning (22-21)

WARNING!

The inverter and motor may start unexpectedly during Auto-Tuning, which could result in death or serious injury. Make sure the area surrounding of the motor and load are clear before proceeding with Auto-Tuning.

- (1) Please set 00-00=5 and then set 22-21=1, before selecting PM motor tuning, enter the motor data (22-00)~(22-06) according to the motor nameplate and the number of encoder pulses (20-27).
- (2) When 22-21=1, press the enter key to go to the PM motor tuning screen. The keypad will display the message of "IPrdy" (Ready to Tune), press run to start the PM motor tuning. The keypad will display the "IPtun" message during auto-tune.
- (3) If the motor is successfully tuned, the message of "IPEnd" will be displayed. If auto-tune is aborted with the stop key, the operator will display the message of "IPbrd"(PM motor tuning aborted).

Note :

If inverter already performed motor auto tuning, it is not required to perform motor tuning again when re-powered up.

(15) Fault History of PM Motor Tuning (22-22)

If PM motor tuning has field, the "IPErr" message is shown on the keypad (PM motor tuning failure). Refer to section 5 for the possible error causes and trouble shooting.

PM motor tuning fault history (22-22) only stores the result of the last auto-tune performed. If auto-tuning was successful or aborted, no error will be displayed.

(16) PM SLV acceleration time (22-23)

PM SLV acceleration time is the acceleration time from static to I/F Mode Start Frequency Switching Point (22-11).

Note :

If occur error or vibration in PMSLV mode. Suggest to increase or decrease acceleration time. Please adjust acceleration time by different application.

(17) Detection Mode Selection of Initial Magnetic Pole (22-25)

Select the motor activation's rotor position detection method

Method 0: Do not detect rotor position, start by directly using the angle when the motor was previously stopped

Method 1: Use input pulse signal to detect rotor position.

Method 2: Use input continuous variable frequency signal to detect rotor position.

(18) Estimator Mode (22-26)

It is suggested to set 22-26=0 when SPM motor is used. Inverter starts in I/f mode and the relevant adjustable parameters are 22-10 & 22-11.

It is suggested to set 22-26=1 when IPM motor is used and speed control mode is performed by the speed control ratio 1:50. Inverter will input the continuously variable frequency signal to motor and the relevant adjustable parameters are 22-27 & 22-28.

(19) Voltage Command of Mode 2 (22-27)

When 22-25=2 or setting of parameter 22-26 is enabled, input of the voltage amplitude setting for the continuously variable frequency signal will influence the motor jittering. When the motor starts and the rotor jitter occurs, it is required to increase the voltage amplitude to ensure the accuracy of detection angle.

Note: When the voltage value is set too high, overcurrent error may occur.

(20) Divider Ratio of Mode 2 (22-28)

When 22-25=2 or setting of parameter 22-26 is enabled, the input of continuous signal frequency depends on the parameter (11-01) carrier setting. If the carrier setting is higher, it is required to appropriately increase the divider ratio so as to reduce the input of continuous signal frequency and ensure the accuracy of detection angle.

(21) Flux-weakening Voltage Command Restriction (22-29)

It is set for preventing the saturation of the output voltage. Inverter performs flux-weakening control by the percentage of input power supply voltage as the limit of output voltage command. If flux-weakening current command restriction (22-18) is set too low, inverter output voltage may exceed the voltage command limit.

(22) IPM Estimator Gain (22-34)

When the estimator mode (22-26) setting is 1, the estimator gain is the multiple of the bandwidth. The larger the setting value, the faster the motor response. However, if the value is too high, the control item will exhibit vibration and become unstable. The smaller the setting value, the greater the speed deviation. Please adjust the appropriate setting value according to the site equipment.

Group 23 Pump & HVAC Function Parameters

23- 00	Function Selection
Range	【 0 】 : Disable 【 1 】 : Pump 【 2 】 : HVAC 【 3 】 : Compressor

- Refer the wiring diagram of single/multi-pump in chapter 3.3.
 - Select function of pump or HVAC via parameter 23-00. This function is enabled if PID control mode (10-03) is enabled. Function of pump or HVAC affects PID target value and if parameter group 23 are enabled. °
 - When 23-00=1, LCD keypad switches automatically the main screen monitoring (16-00) to operating pressure setting (12-74), the sub-screen monitoring 1 (16-01) to pressure feedback value (12-75) and sub-screen monitoring 2 (16-02) to output frequency (12-17).
 - When 23-00=2, LCD keypad switches automatically the main screen monitoring (16-00) to flow meter target setting (12-77), the sub-screen monitoring 1 (16-01) to flow meter feedback (12-71) and sub-screen monitoring 2 (16-02) to output frequency (12-17).
 - When 23-00=3, selection of main frequency command source (00-05) can be set except PID mode and V/F curve is limited to F (01-00). Middle output voltage (01-07) is automatically set to the half of maximum output voltage and parameter 01-00 will be hidden.

Note1 : Refer to the setting value of parameter 23-05 for the display of LED keypad.

Note2 : When the control mode switched to 00-00, the selection of 23-00=1 or 3 is disabled

23- 01	Setting of Single & Multiple Pumps and Master & Alternative
Range	【 0 】 : Single Pump 【 1 】 : Master 【 2 】 : Slave 1 【 3 】 : Slave 2 【 4 】 : Slave 3

- Set the inverter as the Master or Slave 1~3 via parameter 23-01. Refer to Fig 4.3.119 for the functional process of dual pump start to enable multiple pumps in parallel. It is required to reconnect to write in the parameter after it is set.

23- 02	Operation Pressure Setting
Range	【 0.10 ~ 650.00 】 PSI

- Set the pressure value depending on the pressure transmitter of pump system after setting 10-00 to 0 (keypad given).

23- 03	Maximum Pressure of Pressure Transmitter
Range	【 0.10 ~ 650.00 】 PSI

- Set the maximum pressure value depending on the pressure transmitter of pump system. Parameter 23-02 is limited to this maximum value.

23- 04	Pump Pressure Command Source
Range	【0】 : Set by 23-02 【1】 : Set by AI

- Pressure command source is given the value set by 23-02 (Operation Pressure Setting) or AI. Refer to parameter 10-00 for the setting of AI terminal.

23- 05	Display Mode Selection	*2
Range	【0】 : Display of Target and Pressure Feedback 【1】 : Only Display Target Pressure 【2】 : Only Display Pressure Feedback	

- This function can have the common display of target & feedback pressure or display separately
 - When 23-05=0000, LED keypad displays pressure setting value and pressure feedback

20 10
2.0 1.0

Two-digit in the left is the pressure value setting and two-digit in the right is the pressure feedback value in the seven-segment monitor. When 23-00=2 (HVAC), the unit will be multiplied by 1000 times. If the display value is 5.0, it means 5000GPM

- When 23-05=0001 : LED keypad only displays the pressure setting value.

20.0
02.0

- When 23-05=0002 : LED keypad only displays the pressure feedback value.

0.10
_0 1.0

Note:

If Pump mode is used LED keypad, parameter 23-03 is required to ≤ 99.0 PSI.

If Pump mode is used PID mode, the value of 10-33 is required to ≤ 999 and 10-34=1.

23- 06	Proportion Gain (P)
Range	【0.00~10.00】
23- 07	Integral Time (I)
Range	【0.0~100.0】 Sec
23- 08	Differential Time (D)
Range	【0.00~10.00】 Sec

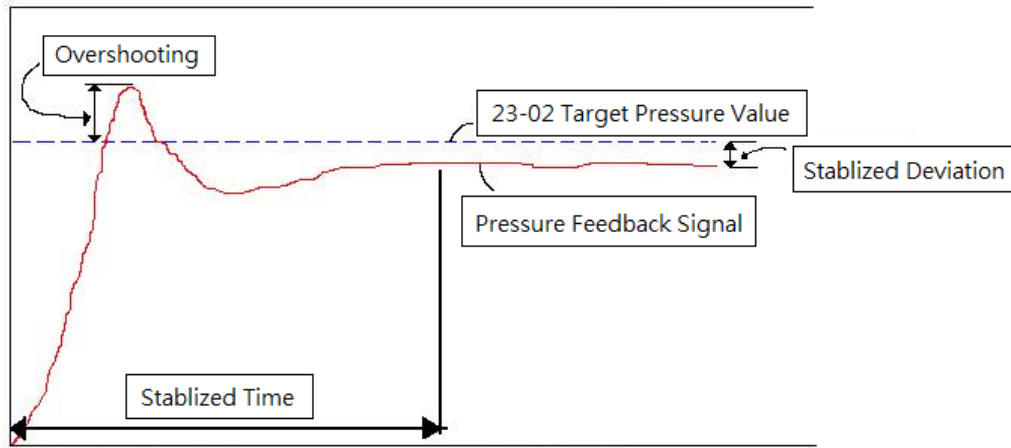

Fig. 4.4.103 Diagram of pressure feedback value

Table 4.3.17 Guide for PID parameter adjustment

	Increase Setting Value	Decrease Setting Value	Main Feature
Proportional Gain (P)	(Pros) Increase response time (Cons) Might cause pump jittering	(Pros) Reduce jittering (Cons) Slow down response	Increase stabilized time
Integral Time (I)	(Pros) Smooth output frequency (Cons) Slow down response	(Pros) Fast response (Cons) Change rapidly output frequency	For smooth feedback variations
Differential Time (D)	(Pros) Avoid overshooting (Cons) System instability or motor jittering	(Pros) System stability (Cons) Overshooting easily	Respond to system rapid variations

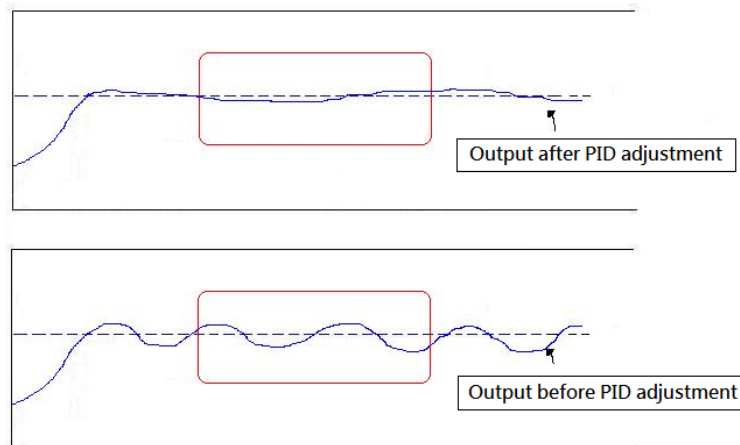

Fig. 4.3.102 PID Diagram for PID parameter adjustment

- PID parameters can be modified during the inverter is running.
- Cons: Disadvantage , Pros: Advantage

23- 09	Tolerance Range of Constant Pressure
Range	【0.01 ~ 650.00】 PSI
23- 34	Tolerance Range of Constant Pressure 2
Range	【0.01 ~ 650.00】 PSI

- When pressure feedback value is higher than 23-02 (operation pressure setting), inverter output frequency will decrease downward into sleep status. PID starts (output frequency will

increase) when pressure feedback value is less than (23-02) – (23-09).

23- 10	Sleep Frequency of Constant Pressure
Range	【0.0~400.0】 Hz

- When inverter output frequency falls below 23-10 (sleep frequency of constant pressure), it starts to count the sleep time (23-11).

* : (When the motor’s maximum output frequency is over than 300Hz, the frequency resolution is 0.1Hz.)

23- 11	Sleep Time of Constant Pressure
Range	【0.0~255.5】 Sec

- When the inverter finishes counting the sleep time (23-11), the output frequency falls downward at the deceleration time (00-15) and gets into sleep status. Parameter 23-10 (sleep frequency of constant pressure) is dedicated by the pump and it is not applied to parameter 10-17 (start frequency of PID sleep).

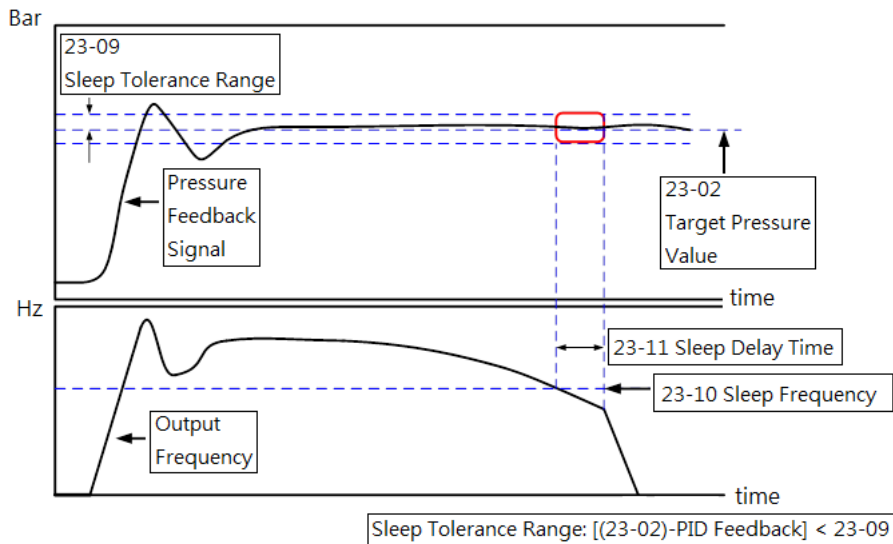

Fig. 4.3.103 Diagram for stop time of constant pressure

23- 12	Maximum Pressure Limit
Range	【0.00 ~ 650.00】 PSI

- It is convenient for user to limit maximum pressure. When pressure feedback value is higher than maximum pressure limit, the inverter displays warning signal and then stops.

23- 15	Minimum Pressure Limit
Range	【0.00 ~ 650.00】 PSI

- It is convenient for user to limit minimum pressure. When pressure feedback value is lower than minimum pressure limit, the inverter displays warning signal and then stops.

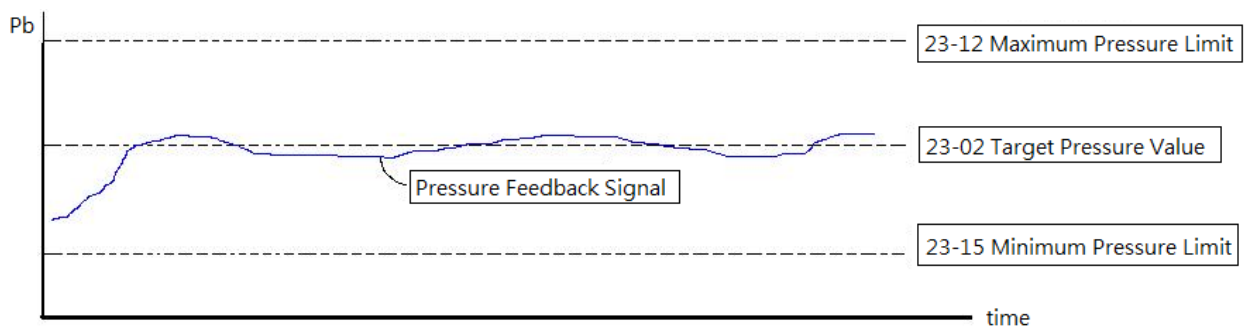

Fig. 4.3.104 Diagram for pressure feedback limit

- The pressure under the control of PID is between the maximum pressure limit (23-12) and minimum pressure limit (23-15).

23-13	Warning Time of High Pressure
Range	【0.0 ~ 600.0】 Sec

- When pressure feedback value is higher than maximum pressure limit, warning time of high pressure starts to count. If pressure feedback value is lower than maximum pressure limit during counting time, the warning time will recount and the inverter will display the warning signal of HIPb when the warning time ends.

23-14	Stop Time of High Pressure
Range	【0.0 ~ 600.0】 Sec

- When the warning signal of high pressure occurs and pressure feedback value is higher than maximum pressure limit, stop time of high pressure starts to count. If pressure feedback value is lower than maximum pressure limit during counting time, the stop time will recount and the inverter will display stop error signal of OPbFt when the stop time ends.

Note:

When user does not want the inverter to be restricted by the maximum pressure, set 23-74=0 (disable) to disable the function of high pressure limit.

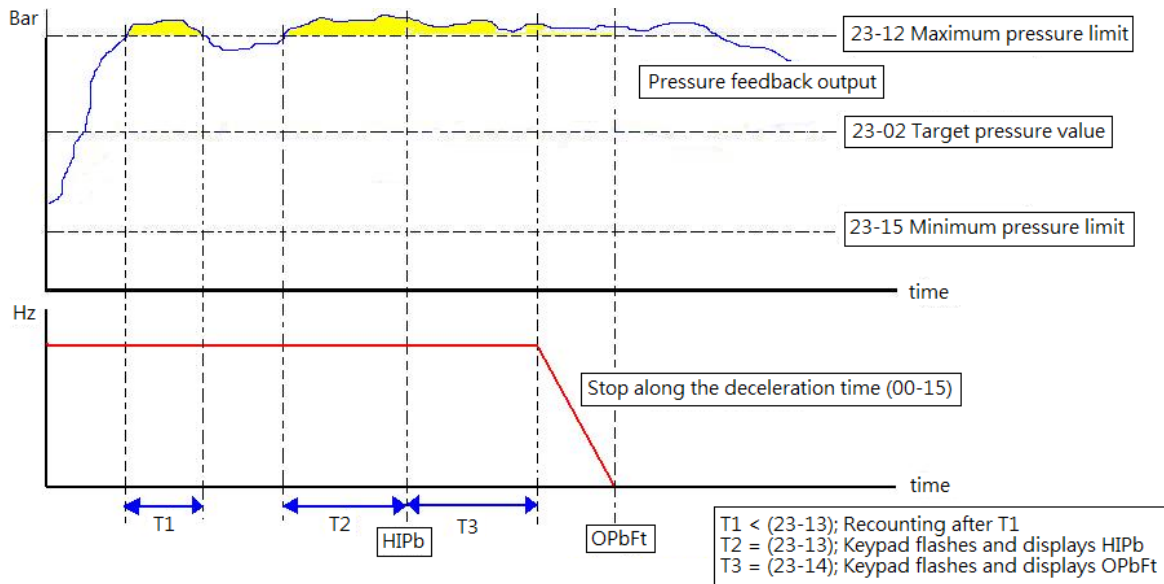

Fig. 4.3.105 Diagram for warning to stop at high pressure limit

23-16	Warning Time of Low Pressure
Range	【0.0 ~ 600.0】 Sec

- When pressure feedback value is lower than minimum pressure limit, warning time of low pressure starts to count. If pressure feedback value is higher than minimum pressure limit during counting time, the warning time will recount and the inverter will display the warning signal of LoPb when the warning time ends.

23-17	Fault Stop Time of Low Pressure
Range	【0.0 ~ 600.0】 Sec

- When the warning signal of low pressure occurs and pressure feedback value is lower than minimum pressure limit, stop time of low pressure starts to count. If pressure feedback value is higher than minimum pressure limit during counting time, the stop time will recount and the inverter will display stop error signal of LPbFt when the stop time ends.

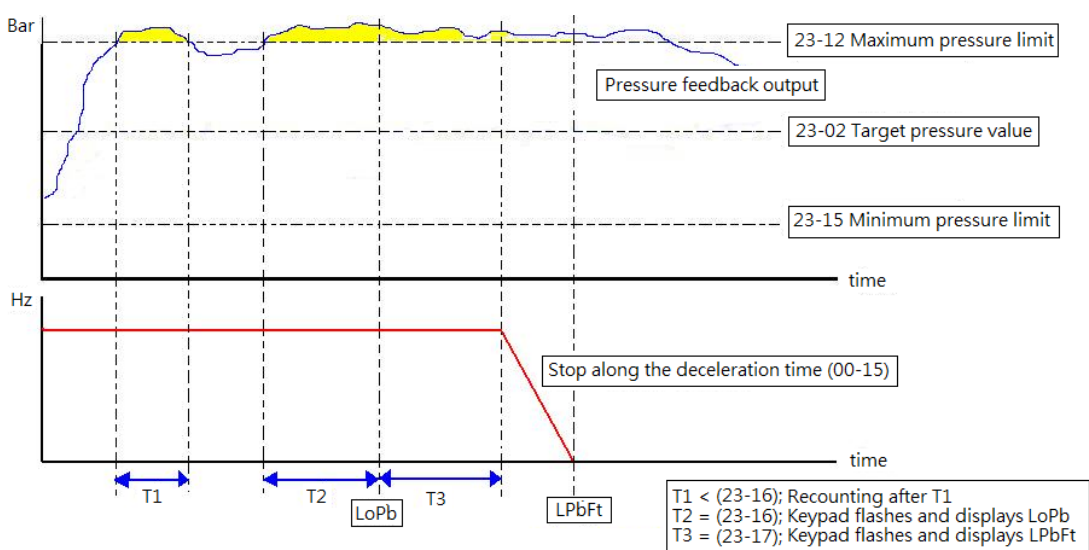

Fig. 4.3.106 Diagram for warning to stop at low pressure limit

Note:

When user does not want the inverter to be restricted by the minimum pressure, set 23-75=0

(disable) to disable the function of low pressure limit.

23- 18	Time of Loss Pressure Detection
Range	【0.0 ~ 600.0】 Sec
23- 19	Proportion of Loss Pressure Detection
Range	【0 ~ 100.0】 %

- When 23-19 = 0 or 23-78 = 0, function of loss pressure detection is disabled.
- When 23-19 > 0, If the feedback pressure value is lower than the value of **【(23-02) x (23-19)】** and the detection time of loss pressure (23-18) passes, the inverter jumps to fault signal (FBLSS).

23- 22	Slave Trip Frequency
Range	【0.0~599.0】 Hz

If Master and Slave start to run at the same time, Slave will stop depend on the condition listed as below:

- (1) When 23-22=0 Hz, if output frequency of Slave is lower than 23-10 (Sleep Frequency of constant Pressure) and after the time of 23-11 (Sleep Time of Constant Pressure), the Slave will be stop automatically. °
- (2) When 23-22 = 1~599 Hz (The maximum frequency follow 01-02), if the output frequency of slave is lower than 23-22, Master will inform Slave to stop and enter sleep mode, or output frequency of Slave is lower than 23-10 (Sleep Frequency of Constant Pressure) and after the time of 23-11 (Sleep Time of Constant Pressure), the Slave will be stop automatically.

23-23	Direction of Water Pressure Detection
Range	【0】 : Upward Detection 【1】 : Downward Detection
23- 24	Range of Water Preesure Detection
Range	【0.00 ~ 65.00】 PSI

- When upward detection of water pressure starts, water pressure will slightly increase. At this time, it may cause shortly pressure fluttering or instability if water consumption continues. It is recommended to reduce the range of water pressure detection (23-24) but it will extend the time of inverter jumping into sleep without water consumption or with mild water consumption.

23- 25	Period of Water Preesure Detection
Range	【0.0 ~ 200.0】 Sec

- 23-25 = 0.0 (sec) means to disable the function of water pressure detection.
- When function of water pressure detection is enabled, it can shorten the time of jumping into sleep without water consumption or with mild water consumption.
- If water consumption frequently continues, it is recommended to extend the cycle of water pressure detection (23-25) so as the detection times can be reduced and the occurrence of fluttering or instability during water pressure detection in constant pressure can be avoided.

23- 26	Acceleration Time of Water Pressure Detection
Range	【0.1 ~ 6000.0】 Sec
23- 27	Deceleration Time of Water Pressure Detection
Range	【0.1 ~ 6000.0】 Sec

- 23-26 and 23-27 are corresponding to 00-16 and 00-17, so the setting of 23-26 changed with the setting of 00-16. When 23-26 value changed, the value of 00-16 will be changed automatically, avoid using multi-speed application function while using PUMP function.

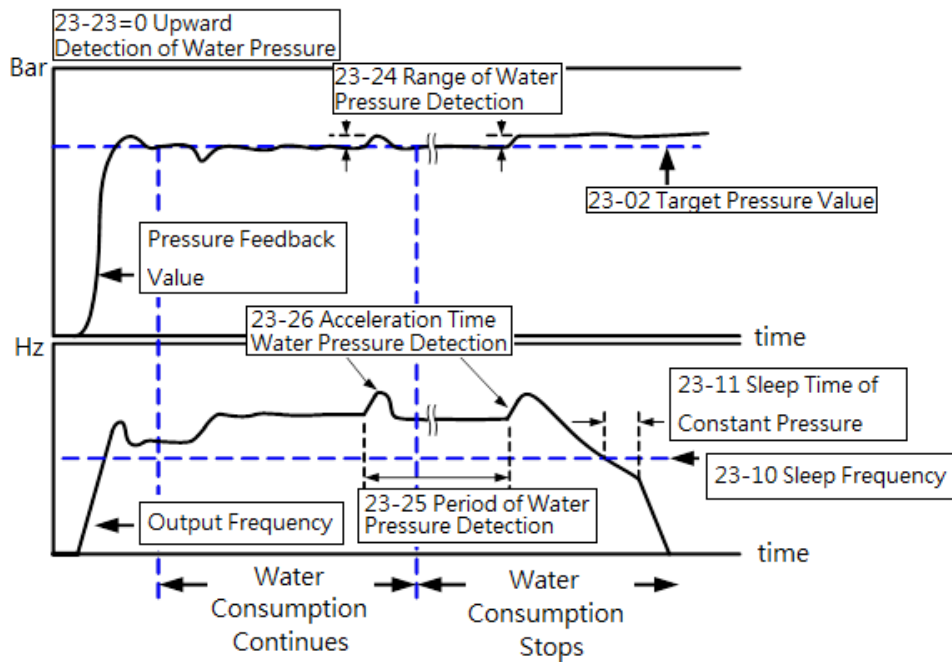

Fig. 4.3.107 Diagram for upward detection of water pressure

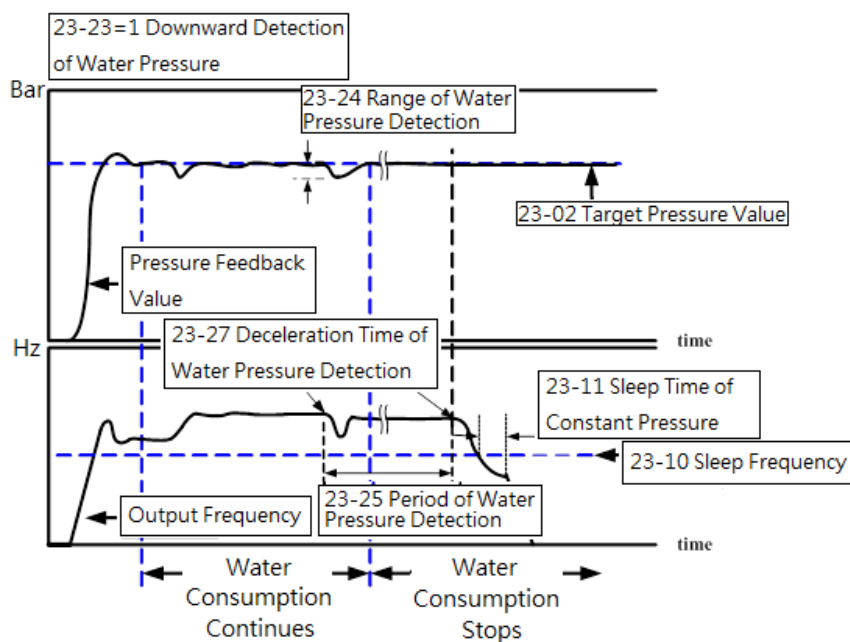

Fig. 4.3.108 Diagram for downward detection of water pressure

- When downward detection of water pressure starts, the output frequency will decelerate with the deceleration time of water pressure detection (23-27). Water pressure reduces with the deceleration when water consumption continues and pressure feedback value rises if the value is lower than that of target pressure value (23-02) - range of water pressure detection (23-24). It may cause shortly fluttering or instability during water detection process. User can appropriately adjust the range of water pressure detection (23-24) to avoid the occurrence of

severe flutter. Mild water consumption result in pressure reducing during deceleration and the inverter's output frequency may decrease to sleep frequency. But if pressure feedback value is lower than that of target pressure value (23-02) - range of water pressure detection (23-24), the output frequency will accelerate again.

Table 4.3.18 Guide for comparison of water pressure detection direction

	Pros	Cons
Upward detection of water pressure	Keep the pressure above the target pressure during this process for strict and precise applications	<ol style="list-style-type: none"> 1. If "Pump lift" is too high, operation frequency is higher without water consumption or with mild water consumption. So this detection effect is too restricted to jump into sleep. 2. Energy-saving of water flow is not obvious and Slave is not easy to sleep under the multiple pumps in parallel.
Downward detection of water pressure	<ol style="list-style-type: none"> 1. Jump into sleep status without water consumption or with mild water consumption. 2. For energy-saving purpose, under the multiple pumps in parallel regulate the pumps to the optimum operation state during this process. 3. Startup sequency is by Master, Slave 1, Slave 2, and Slave 3. Sleep sequency is by Slave 1, Slave 2, and Slave 3 and Master. After the switching time is allowable, alternate Master and Slave reach the average of life expectancy. 	Pressure fluctuations may occur during this process if user inappropriately regulates the range of water pressure detection (23-24) and the deceleration time of water pressure detection (23-27).

23- 28	Foreced Run Command
Range	【0.00 ~ 599.00】 Hz

- This function is enabled when PID mode (10-03) is selected. Pump will not depend on the feedback to make any PID output adjustment and runs the frequency of 00-05 (Frequency command) when multi-function digital input (S1~S6) is set to 16 (PID control disable).
- When the other digital input is set to 57 (forced frequency run), inverter sets the frequency to run depending on the parameter 23-28 (forced run command). If PID function disable is removed, the inverter is controlled by PID.

23-29	Switching Time of Multiple Pumps in Parallel
Range	【0 ~ 240】 hour/min

- If function of multiple pumps in parallel is enabled, the switching way is Master→Slave1→ Slave2→Slave3 → Master → ... and the switching time is set via parameter 23-72.

23- 30	Detection Time of Multiple Pumps in Parallel Running Start
Range	【0.0 ~ 30.0】 Sec

- When parameter 23-31 is set to 1 or 3, detection time of multiple pumps in parallel running start is enabled. If water pressure can not reach the error range of constant pressure and water flow time is over the detection time (23-30), Master will inform Slave of running start.

23- 31	Synchronous Selection of Multiple Pumps in Parallel
Range	【0】 : Disable 【1】 : Pressure Setting and Run/ Stop 【2】 : Pressure Setting 【3】 : Run/Stop

- When 23-31=0 : Disabled
- When 23-31=1 : Set 23-01 to 1, Pressure setting and Run/ Stop command are modified by master and Slave follows Master's command. Run/Stop command from Slave can be regarded as the emergency stop command with the highest priority.
- When 23-31=2 : Pressure setting is modified by Master and Slave follows Master's command to update synchronously.
- When 23-31=3 : Run/ Stop command is set by Master and Slave follows Master's command. Run/Stop command from Slave can be regarded as the emergency stop command with the highest priority.

Note:

1. When Master modifies the pressure setting, it requires pressing ENTER key to modify the pressure setting of Slave.
2. When the switching time of multiple pumps in parallel (23-29) changes and reconnection, it will recount the time.

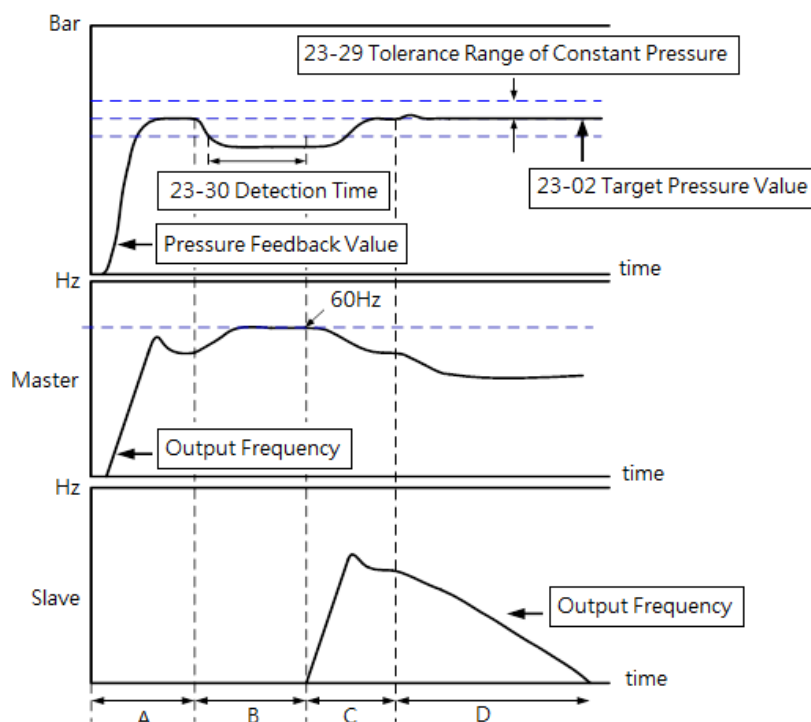

Fig. 4.3.109 Dual pumps start up process

- A. Dual pumps are enabled during this time. Master starts up first and Slave is in standby to enter constant-pressure operation.
- B. Large water consumption results in the higher operation frequency of Master. If water pressure is not lower than the tolerance range of constant-pressure and the operation time is not over the detection time (23-30), Slave is still in standby.
- C. If it is over the detection time (23-30), and Master runs at 60Hz, Master informs Slave of auxiliary kicking water. After Slave operates, the operation frequency of Master and Slave reduces to the operation of constant-pressure if water consumption is stable.
- D. If water consumption is mild, the operation frequency of Master and Slave reduces. Because the water consumption is less than that of the operation of dual pumps, Slave stops to sleep (please refer to parameter 23-22 for dual pump slave sleep requirements) and only Master runs to reach constant-pressure operation.

Note 1 :

When 23-35=3, If the operation time is over the switching time (23-29) or sleep to stop under the operation of dual pumps, the dominance between Master and Slave will exchange to operate.

Note 2 :

When 23-01≠0, the parameter 23-01 of these two inverters can not be simultaneously set to 1 or 2. That is, the parameter 23-01 of one inverter is set to 1 and that of the other inverter should be set to 2 and vice versa.

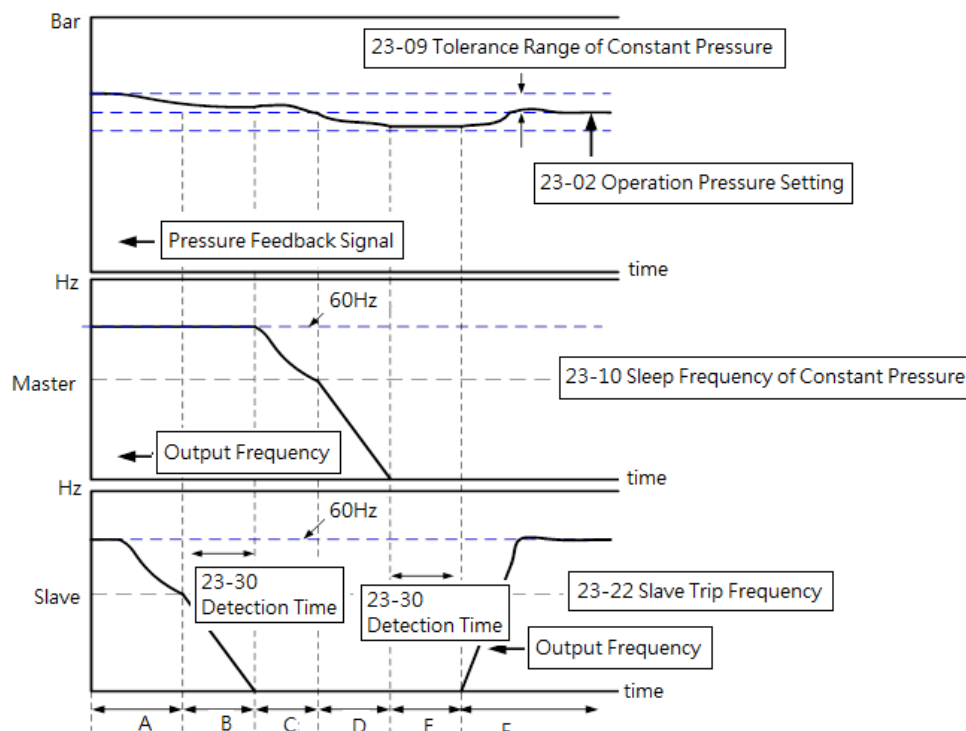

Diagram of sleep stop alternative selection action

Note:

- A. Dual pumps are enabled during this time. Higher operation pressure occurs, Master keeps operation and Slave output frequency decreases.
- B. Master operation frequency maintains 60Hz. If water pressure doesn't decrease to the target constant pressure and Slave continuously decreases to the set trip frequency (23-22), Slave detection time (23-30) starts and Slave decelerates to stop.
- C. If milder water consumption and higher water pressure occur and Slave operation command is in sleep status, Master output frequency decreases to let the water pressure be in constant status when the detection time (23-30) is over.
- D. When Master operation frequency decreases to the sleep frequency of constant pressure (23-10), Master will decrease to stop, water consumption is continuously mild and water pressure will reduce slowly.
- E. When water consumption stops, Master jumps into sleep and the pressure remains the same. and Slave's detection time (23-30) starts.
- F. When the detection time (23-30) is over, shift operation stops and virtual Master starts to become Slave. The inverter operates in constant pressure under the target pressure value.

23-35	Selection of Multiple Pumps Shift Operation
Range	【0】 : No function 【1】 : Timer Alternative Selection 【2】 : Sleep Stop Alternative Selection 【3】 : Timer and Sleep Stop Alternative Selection 【4】 : Multiple Pumps Test Mode

- When 23-35=1, the Master and Slave of multiple pumps in parallel will be exchange, after the switching time of multiple pumps in parallel. °
- When 23-35=2, when the Master and Slave of multiple pumps in parallel are both in sleep mode, and after the detecting time (23-30), the Master and Slave of multiple pumps in parallel will be exchange. Every time the multiple pumps start, the exchange will be processed. Please refer to the diagram of sleep stop alternative selection action.
- When 23-35=3, Timer alternately selected and sleep stop alternately selected will be enabled at the same time.
- When 23-35=4, When master stop running and the slave need to run, please set 23-35=4, and no exchange between Master and Slave.

23-37	Leakage Detection Time
Range	【0.0~100.0】 Sec
23-38	Pressure Variation of Leakage Detection Restart
Range	【0.01~65.00】 PSI
23-39	Pressure Tolerance Range of Leakage Detection Restart
Range	【0.01~650.00】 PSI

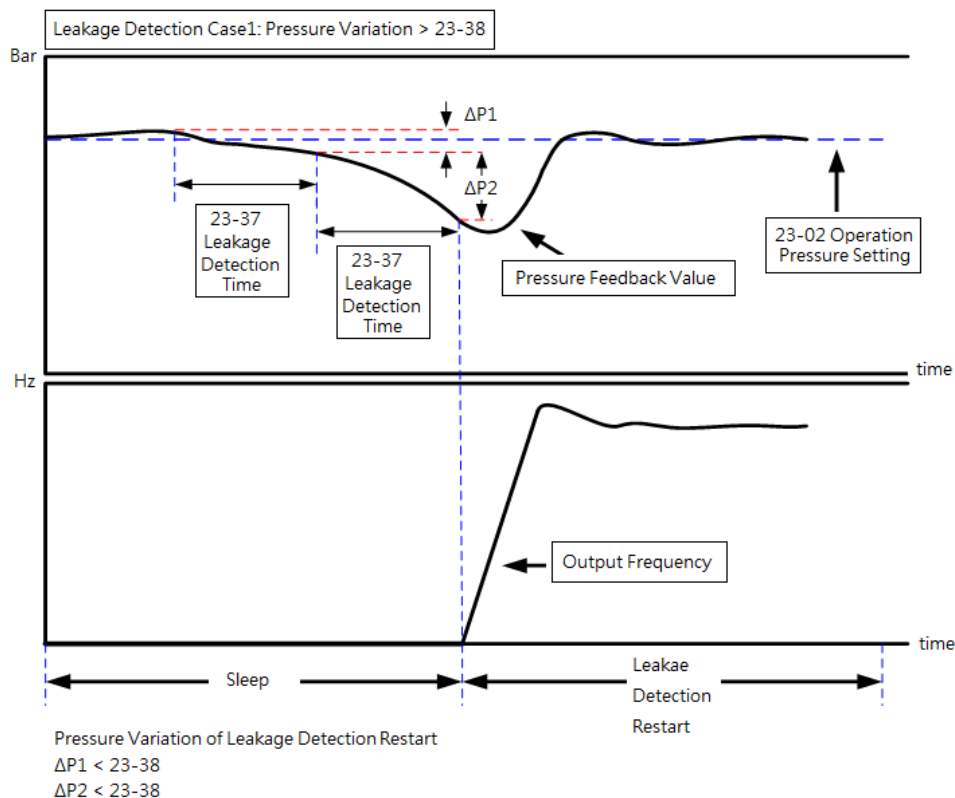

- To limit single inverter to use leakage detection.
- When 23-37 = 0.0 (sec), switch off this function.

- When pump is at shutdown state, pressure will drop over time if pipeline leaks. Pump will restart if pressure variation is larger than the value of parameter 23-38 in every detection time (23-37).

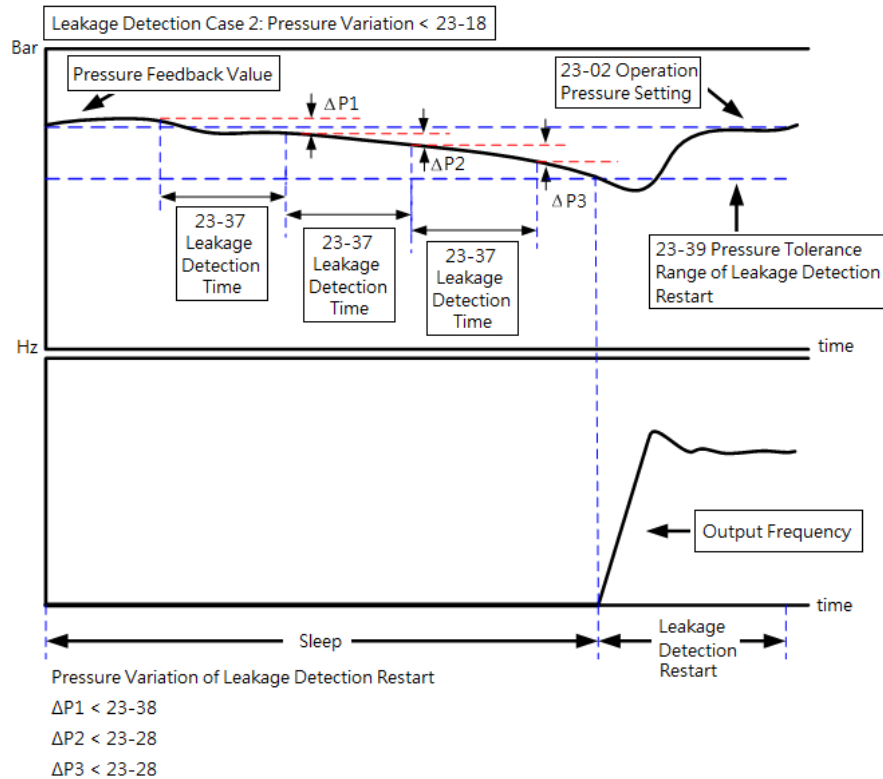

- When 23-37=0.0 (sec), switch off this function.
- When pump is at shutdown state, pressure will drop over time if pipeline leaks. Inverter will keep sleep state if pressure variation is lower than the value of parameter 23-38 in every detection time (23-37) and pump will restart if pressure variation is larger than that of 23-38 or pressure tolerance range is over the value of parameter 23-39 in the detection time.
- Properly adjust the relevant leakage detection parameters 23-37, 23-38 and 23-39 to improve the condition of frequent pump start and stop caused from the dropping pressure of water system due to leakage.
- Function of leakage detection is enabled only in the setting of single pump.

23-71	Maximum Pressure Setting
Range	【0.10 ~ 650.00】 PSI

- 23-02 (Operation pressure setting) is limited by 23-71 (Maximum pressure setting). 23-71 is limited by 23-03 (Maximum Pressure of Pressure Transmitter)

23-72	Switching Time of Alternation in Parallel
Range	【0】 : Hour 【1】 : Minute

- When 23-72=0, parameter 23-29 will be in the unit of hour.
- When 23-72=1, parameter 23-29 will be in the unit of minute.

23-73	Slave Wake-up Selection
Range	【0】 Disable 【1】 Enable

- When multiple pumps are in parallel and the requirements of slave wake-up can not be achieved in tolerance range, user can set parameter 23-73=1 and refer to the following conditions to wake up Slave.
- (1) Master is in full speed operation (01-02 maximum output frequency) but pressure feedback value can not achieve the target pressure value.
- (2) After the period of 30 seconds + time of (23-30), slave will be forced to start (even if the requirement of sleep to wake-up is not achieved and the pressure feedback value is under the tolerance range of constant pressure) and keeps operation to achieve the target pressure value.
- (3) It is required to follow the formula (the set method 1) and refer to the following diagram to set the wake-up requirements.

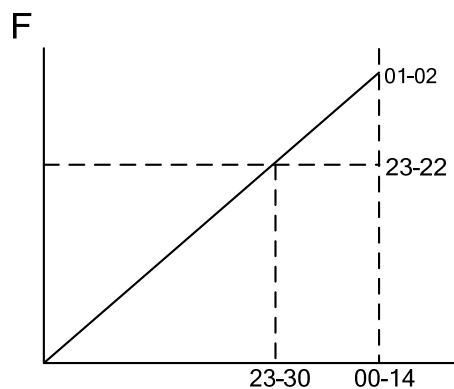

$$\frac{23-30}{00-14} \geq \frac{23-22}{01-02} \text{ -----Set method 1}$$

Diagram of requirements for waking up slave

When the 23-22 (Slave Disconnect Frequency) setting value is too high or 23-30 (Parallel Start Pump Detection Time) is too short, it will make the Slave enter the Sleep Mode, to make the setting ineffective.

23- 74	High Pressure Setting
Range	【0】 Disable 【1】 High Pressure Warning 【2】 High Pressure Warning or Error

- When 23-74=0, High pressure warning or error is disabled.
- When 23-74=1, High pressure warning is enabled. High pressure error is disabled.
- When 23-74=2, High pressure warning or error is enabled. Refer to the instruction of Fig. 4.3.105.

23- 75	Low Pressure Setting
Range	【0】 Disable 【1】 Low Pressure Warning 【2】 Low Pressure Warning or Error

- When 23-75=0, Low pressure warning or error is disabled.
- When 23-75=1, Low pressure warning is enabled. Low pressure error is disabled.

- When 23-75=2, Low pressure warning or error is enabled. Refer to the instruction of Fig.4.3.106.





23- 78	Selection of Loss Pressure Detection
Range	【0】 Disable 【1】 Loss Pressure Warning 【2】 Low Pressure Error

- When 23-78=1, the inverter will display warning signal when detecting the loss pressure.
- When 23-78=2, the inverter will display error signal when detecting the loss pressure.

4.4 Built-in PLC function



The PLC ladder logic can be created and downloaded by TECO DriveLink software.

4.4.1 Basic Command

				P			NO / NC
Inputs					I	i	I1~I8 / i1~i8
Outputs	Q	Q	Q	Q	Q	q	Q1~Q2 / q1~q2
Auxiliary command	M	M	M	M	M	m	M1~MF / m1~mF
Special registers							V1~V7
Counter function	C				C	c	C1~C8 / c1~c8
Timer function	T				T	t	T1~T8 / t1~t8
Analog comparison function	G				G	g	G1~G8 / g1~g8
Operation control function	F				F	f	F1~F8 / f1~f8
summation and subtraction function	AS						AS1~4
Multiplication and division function	MD						MD1~4
Encoder input comparison command	H				H	h	H1~H4/h1~h4

Description of special registers

V1 : Set frequency	Range : 0.1~599.0Hz
V2 : Operation frequency	Range : 0.1~599.0Hz
V3 : AI1 input value	Range : 0~1000
V4 : AI2 input value	Range : 0~1000
V5 : Keypad input value	Range : 0~1000
V6 : Operation current	Range : 0.1~999.9A
V7 : Torque value	Range : 0.1~200.0%

Command	Upper Differential	Lower Differential	Other command symbol
Differential command	D	d	
SET command			
RESET command			
P command			P

Open circuit	" "	" "
Short circuit	"--"	

Connection symbol	Definition
—	Connect components on the left and right side
⊥	Connects components on the left , right and top side
⊕	Connects components on the left , right , top and bottom side
⊓	Connects components on the left , right and bottom side

4.4.2 Basic command function

© D (d) command function

Example 1 : I1-D —[Q1

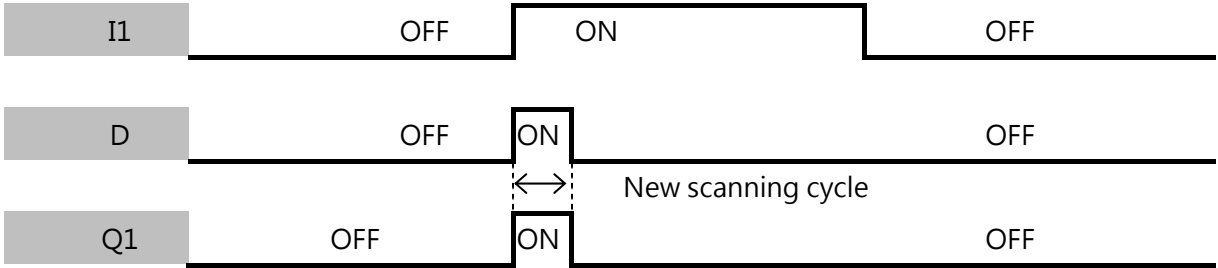

Example 2 : i1-d —[Q1

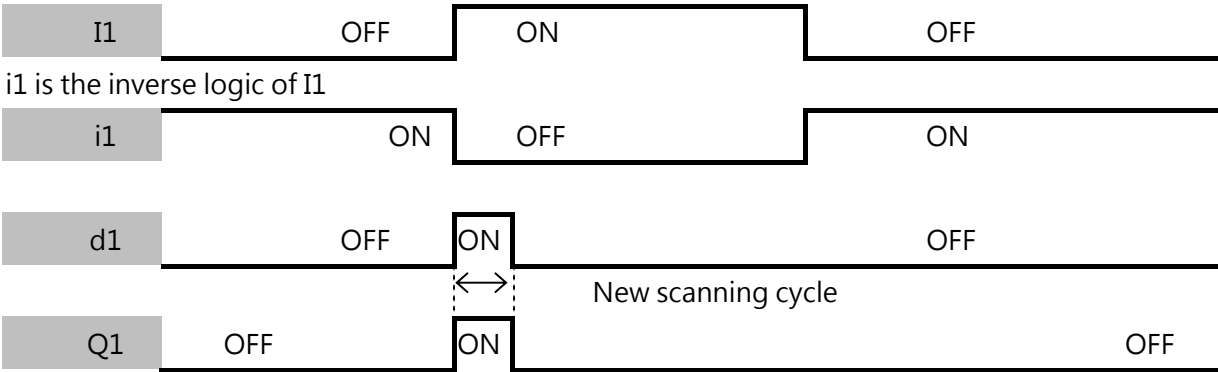

© NORMAL(-[) Output

I1—[Q1

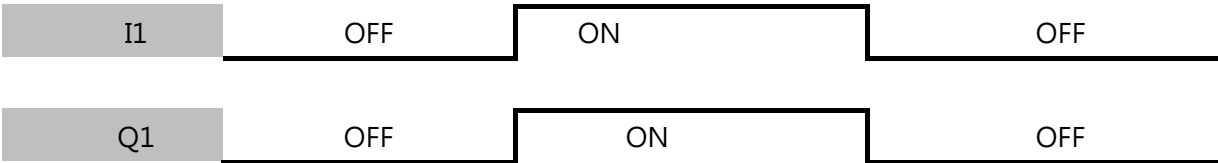

© SET (^) Output

I1—^ Q1

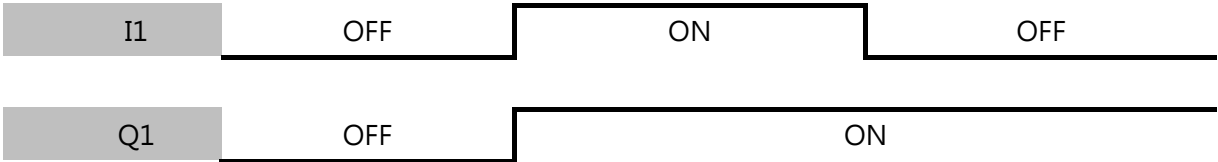

© RESET (v) Output

I1—v Q1



© P mode output

i1 — PQ1



i1 is the inverse logic of I1



4.4.3 Application functions

1. Counter Function

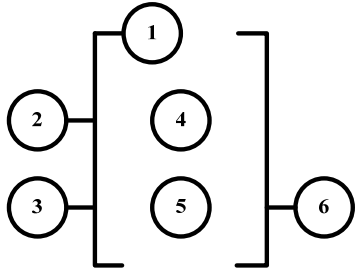

①	Counter mode (1 ~ 4)
②	UP/Down counting modes can be set by (I1 ~ f8).
	OFF: Count up (0, 1, 2, 3...) ON: Count down (...3,2,1,0)
③	Use (I1~f8) to reset counting value
	ON: Internal count value is reset and counter output ⑥ is OFF OFF: Internal counter value retained
④	Internal counter value
⑤	Counter compare value (AS1~AS4,MD1~MD4,T1~T8,C1~C8,V1~V7,constant)
⑥	Counter output (C1 to C8, there are a total of 8 counters)

Counter modes :

- Mode 1 : Counter value is locked to the set value.
The value will not be retained when the power is cut off.
- Mode 2 : Counter value is not locked.
The value will not be retained when the power is cut off.
- Mode 3 : Counter value is locked.
The value will be retained when the power is cut off.
- Mode 4 : Counter value is not locked.
The value will be retained when the power is cut off.

(1) Counter mode 1

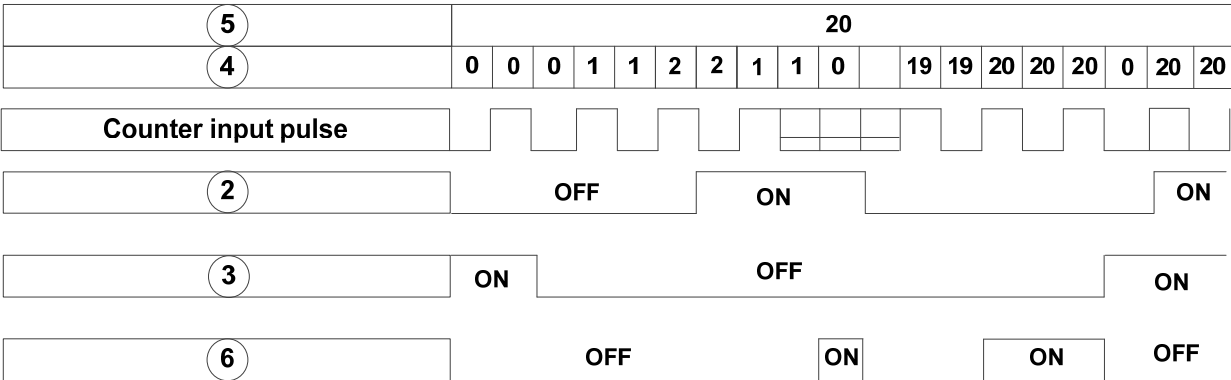

Example :

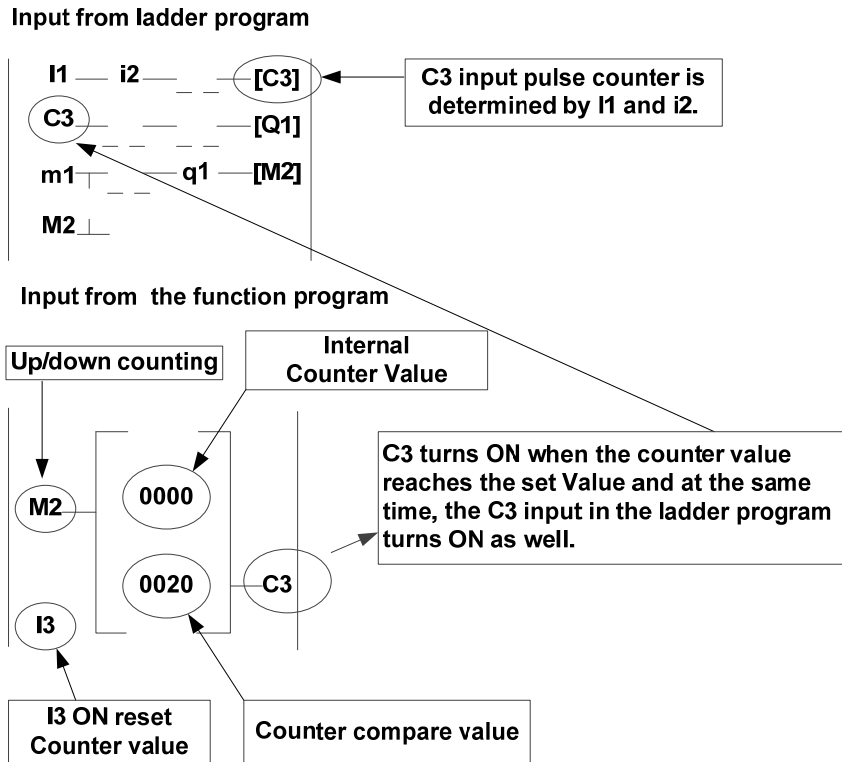

(2) Counter mode 2

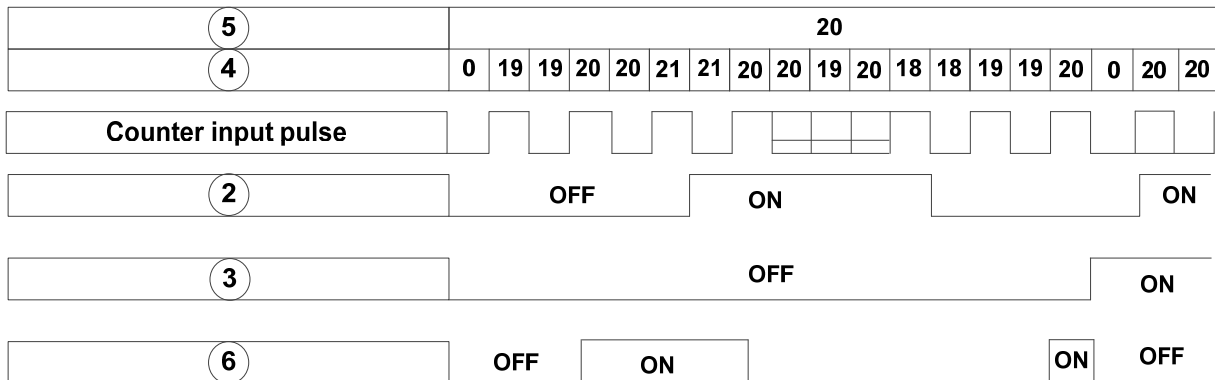

Note:

In this mode the internal counter may increase past the counter compare value, unlike mode 1 where the internal counter value is limited to the counter compare value.

- (1) Counter mode 3 is similar to the counter mode 1, with the exception that the counter value is saved when the drive is powered down and reloaded at power up.
- (2) Counter mode 4 is similar to the counter mode 2, with the exception that the counter value is saved when the drive is powered down and reloaded at power up.

⑤		20														
④	Mode 1 & 2	1	1	2	2							0	1	1	2	2
④	Mode 3 & 4	1	1	2	2	3						3	4	4	5	5

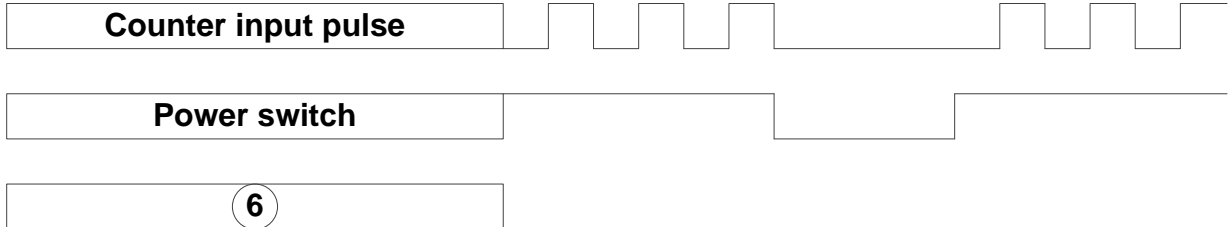

2. Timer Function

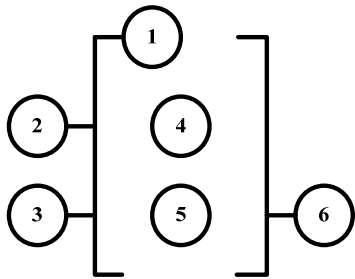

Symbol	Description
①	Timer mode (1-7)
②	Timing unit
	1 : 0.0~999.9 second
	2 : 0~9999 second
	3 : 0~9999 minute
③	Use (I1~f8) to reset timing value
	ON : Internal timing value is reset and timer output ⑥ is OFF OFF : Internal timer stays running
④	Internal timer value
⑤	Timer set value (AS1~AS4,MD1~MD4,T1~T8,C1~C8,V1~V7,constant)
⑥	Timer output (T1 to T8, there are a total of 8 timers)

Timer mode description :

(1) Timer mode 1 (ON-delay Timer mode 1)

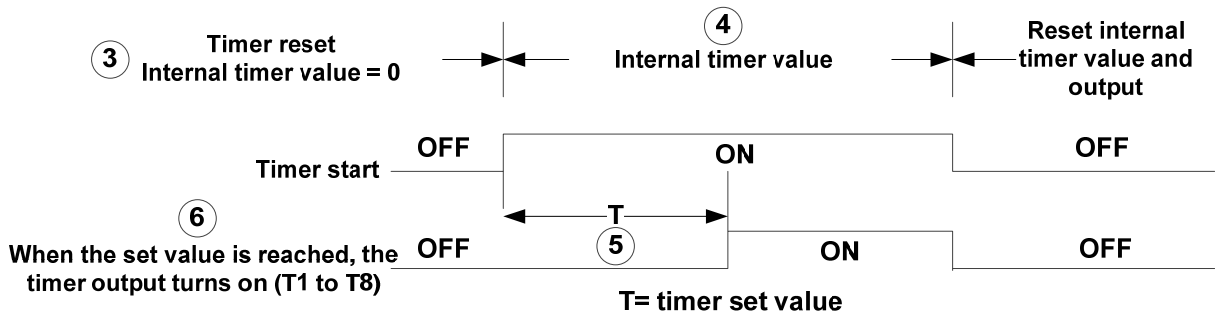

Example :

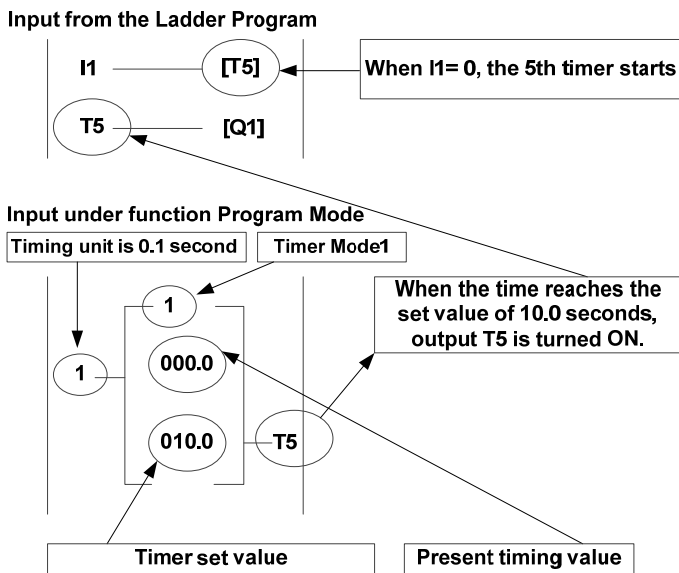

(2) Timer mode 2 (ON-delay Timer mode 2)

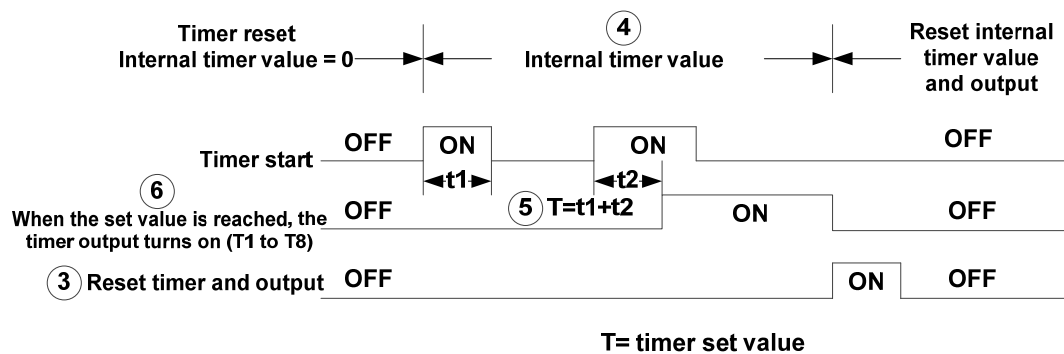

(3) Timer mode 3 (OFF-delay Timer mode 1)

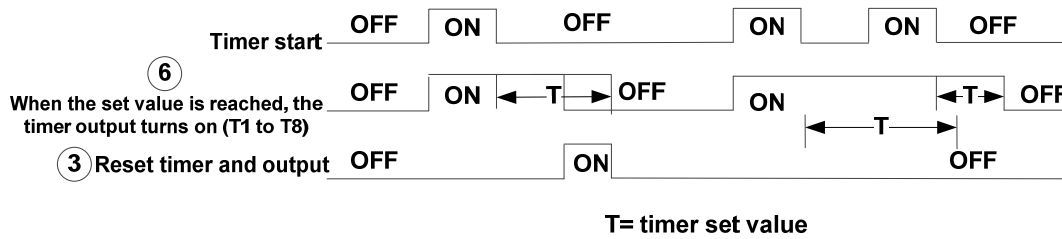
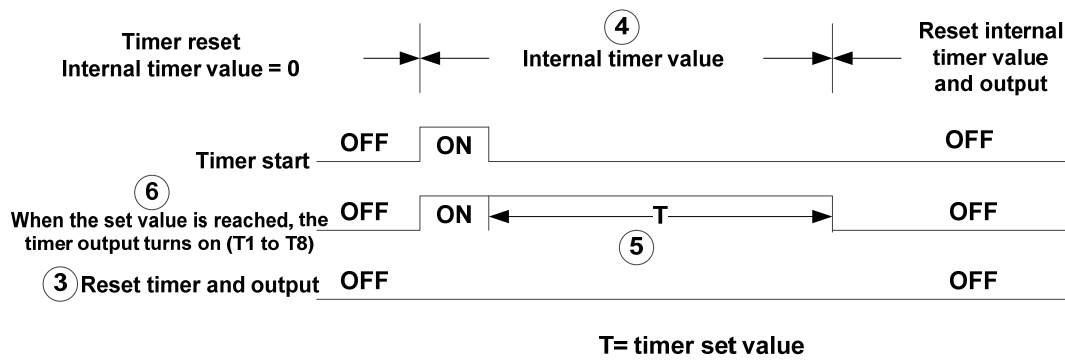

(4) Timer mode 4 (OFF-delay Timer mode 2)

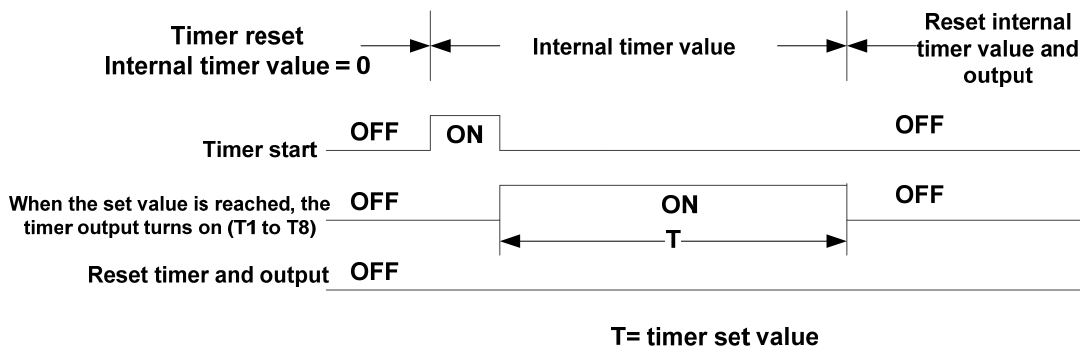

(5) Timer mode 5 (FLASH Timer mode 1)

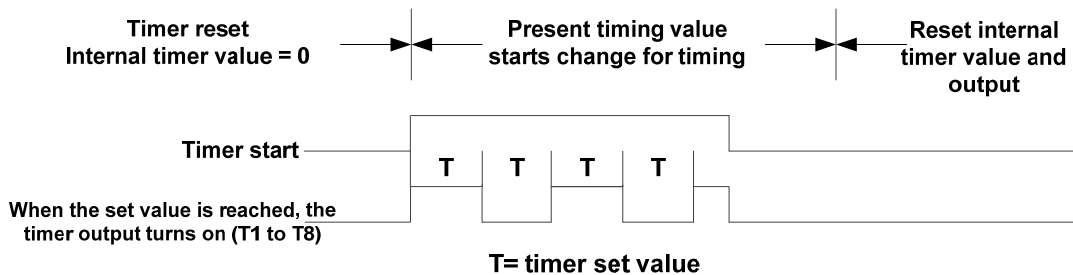

(6) Timer mode 6 (FLASH Timer mode 2)

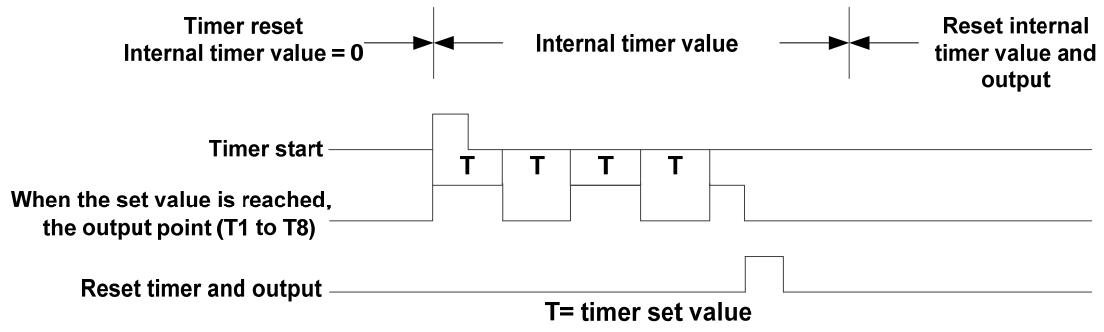

(7) Timer mode 7 (FLASH Timer mode 3)

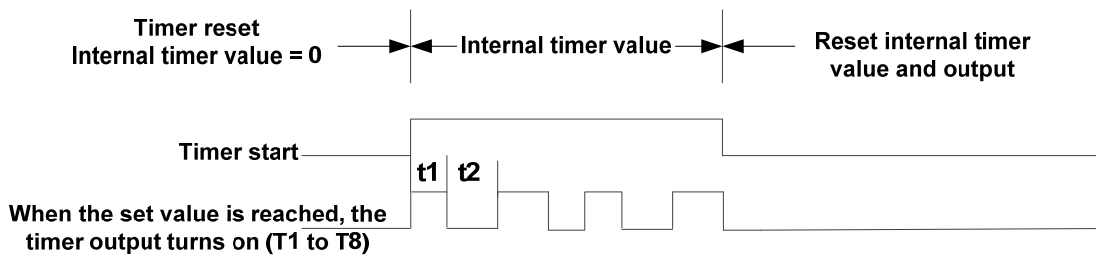

3 · Analog comparator function

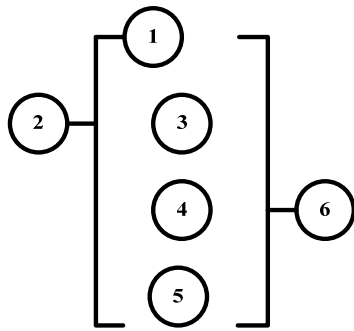

Symbol	Description
①	Analog comparator mode (1~3)
②	Input comparison value selection (AS1~AS4,MD1~MD4,T1~T8,C1~C8,V1~V7)
③	Current analog input value
④	Set the reference comparison value (Upper limit) (AS1~AS4,MD1~MD4,T1~T8,C1~C8,V1~V7, constant)
⑤	Set the reference comparison value (lower limit) (AS1~AS4,MD1~MD4,T1~T8,C1~C8,V1~V7, constant)
⑥	Comparator output (G1 to G8, there are a total of 8 comparators)

The description of analog comparison mode :

- (1) Analog comparison mode 1 (③ ≤ ⑤, ⑥ ON)
- (2) Analog comparison mode 2 (③ ≥ ④, ⑥ ON)
- (3) Analog comparison mode (⑤ ≤ ③ ≤ ④, ⑥ ON)

Input comparison value selection (V1~V7)

- (1) Input comparison value selection = V1 : Set frequency
- (2) Input comparison value selection = V2 : Operation frequency
- (3) Input comparison value selection = V3 : AI1 input value
- (4) Input comparison value selection = V4 : AI2 input value
- (5) Input comparison value selection = V5 : Keypad input value
- (6) Input comparison value selection = V6 : Operation current
- (7) Input comparison value selection = V7 : Torque value

4. Operation control function

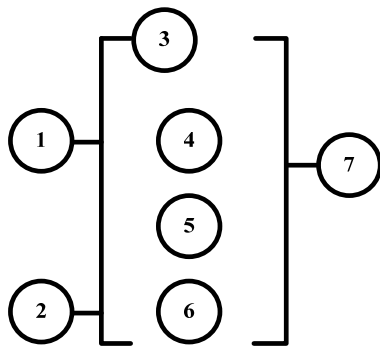

Symbol	Description
①	Forward /Reversal control can be set by (I1~f8) OFF : Forward(FWD) ON : Reversal(REV)
②	Speed terminal control can be set by (I1~f8)
	OFF : Operation based on ③ set frequency ON : Operation based on frequency of speed ④
③	Set frequency (can be constant or V3 · V4 · V5)
④	Speed frequency (can be constant or V3 · V4 · V5)
⑤	Acceleration time (ACC Time)
⑥	Deceleration time (DEC Time)
⑦	Operation command output (F1 to F8, there are a total of 8 operation control functions)

Example :

Input from the Ladder Program

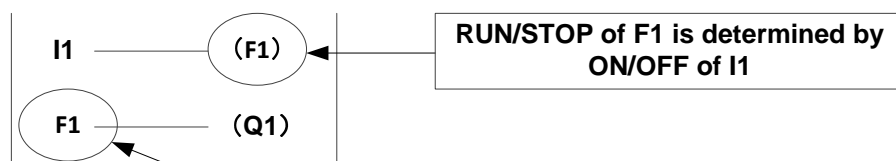

Input from Function Program

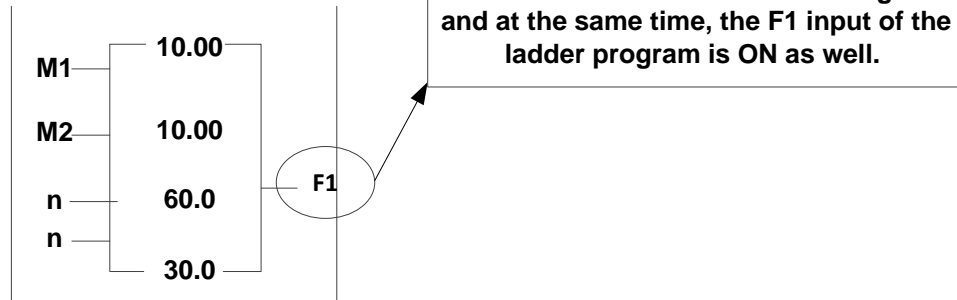

5. Summation and subtraction functions

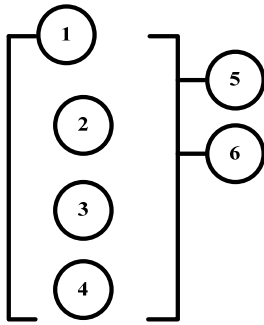

RESULT (calculation result) = V1+ V2- V3

Symbol	Description
①	Calculation result : RESULT
②	Addend V1(AS1~AS4,MD1~MD4,T1~T8,C1~C8,V1~V7, constant)
③	Addend V2(AS1~AS4,MD1~MD4,T1~T8,C1~C8,V1~V7, constant)
④	Subtrahend V3(AS1~AS4,MD1~MD4,T1~T8,C1~C8,V1~V7, constant)
⑤	Coil output of error signal (M1~MF)
⑥	Addition and subtraction modes number (AS1~AS4)

6. Multiplication and division modes

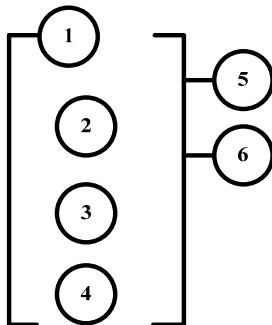

RESULT (calculation result) =V1*V2/V3

Symbol	Description
①	Calculation result : RESULT
②	Multiplier V1(AS1~AS4,MD1~MD4,T1~T8,C1~C8,V1~V7, constant)
③	Multiplier V2(AS1~AS4,MD1~MD4,T1~T8,C1~C8,V1~V7, constant)
④	Divisor V3(AS1~AS4,MD1~MD4,T1~T8,C1~C8,V1~V7, constant)
⑤	Coil output of error signal (M1~MF)
⑥	Multiplication and division modes number (MD1~ MD4)

7、Encoder Input Comparison command

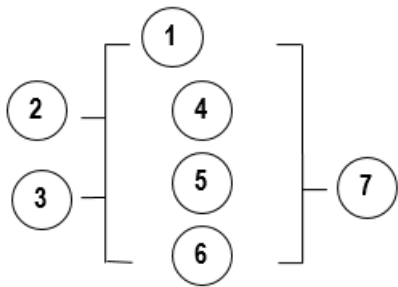

Symbol	Description
①	Encoder control mode (1-2)
②	Up/ Down selection can use (I1~f8) to setup OFF: Up ON: Down
③	Reset can use (I1~f8) to setup
④	A1, Encoder current value / divide rate C (divide rate please refer to item ⑥)
⑤	A2, Setting comparison value
⑥	C, Encoder divide rate
⑦	Encoder comparison output point, H1~H4

- (1) **Control mode 1** Encoder comparison function: $A1/C \geq A2$ compare to output.
 (2) **Control mode 2** Encoder comparison function: $A1/C \leq A2$ compare to output.

※ Encoder input comparison is enable or disable, which is decided by ON /OFF in LADDER program.

Chapter 5 Troubleshooting and Fault Diagnostics

5.1 General

5.1.1 Fault detection function

Table 1 Fault information and possible solutions







LED display	Description	Cause	Possible solutions
Over Current	The inverter output current exceeds the overcurrent level (200% of the inverter rated current).	<ul style="list-style-type: none"> Acceleration / Deceleration time is too short. Contactor at the inverter output side. A special motor or applicable capacity is greater than the inverter rated value. Short circuit or ground fault. 	<ul style="list-style-type: none"> Extend acceleration / deceleration time. Check the motor wiring. Disconnect motor and try running inverter.
OC			
Over Current	The inverter output current exceeds the overcurrent level in acceleration time	<ul style="list-style-type: none"> Acceleration time is too short Capacity of motor is bigger than inverter Short circuit between winding and shell of motor Short circuit between wire and ground of motor IGBT broken module 	<ul style="list-style-type: none"> Set the longer acceleration time Change to bigger capacity of inverter Examine motor Check the wire Replace IGBT module
OCA			
Over Current	The inverter output current exceeds the overcurrent level in acceleration time	<ul style="list-style-type: none"> Acceleration time is too short Capacity of motor is bigger than inverter Short circuit between winding and shell of motor Short circuit between wire and ground of motor IGBT broken module 	<ul style="list-style-type: none"> Set the longer acceleration time Change to bigger capacity of inverter Examine motor Check the wire Replace IGBT module
OCC			
Over Current	The inverter output current exceeds the overcurrent level in deceleration time	<ul style="list-style-type: none"> Deceleration time is too short 	<ul style="list-style-type: none"> Set the longer acceleration time
OCd			
Ground Fault	The current to ground exceeds 50% of the inverter rated output current (08-23 = 1, GF function is enabled).	<ul style="list-style-type: none"> Motor damaged (insulation). Wire damage or deterioration. Inverter DCCT sensors defect. 	<ul style="list-style-type: none"> Replace motor. Check the motor wiring. Disconnect motor and try running inverter. Check resistance between cables and ground. Reduce carrier frequency.
GF			

LED display	Description	Cause	Possible solutions																	
Over voltage	DC bus voltage exceeds the OV detection level : 200V class: 410Vdc 400V class: 820Vdc	<ul style="list-style-type: none"> Deceleration time set too short, resulting in regenerative energy flowing back from motor to the inverter. The inverter input voltage is too high. Use of power factor correction capacitors. Excessive braking load. Braking transistor or resistor defective. Speed search parameters set incorrectly. 	<ul style="list-style-type: none"> Increase deceleration time Reduce input voltage to comply with the input voltage requirements or install an AC line reactor to lower the input voltage. Remove the power factor correction capacitor. Use dynamic braking unit. Replace braking transistor or resistor. Adjust speed search parameters. 																	
OU				Low Voltage	DC bus voltage is lower than the UV detection level or the pre-charge contactor is not active while the inverter is running. 200V class: 190Vdc 400V class: 380Vdc The detection value can be adjusted by 07-13).	<ul style="list-style-type: none"> The input voltage is too low. Input phase loss. Acceleration time set too short. Input voltage fluctuation. Pre-charge contactor damaged. DC bus voltage feedback signal value not incorrect. 	<ul style="list-style-type: none"> Check the input voltage. Check input wiring. Increase acceleration time. Check power source Replace pre-charge contactor Replace control board or complete inverter. 	LU	Input phase loss	Phase loss at the input side of the inverter or input voltage imbalance, active when 08-09 = 1 (enabled).	<ul style="list-style-type: none"> Wiring loose in inverter input terminal. Momentary power loss. Input voltage imbalance. 	<ul style="list-style-type: none"> Check input wiring / faster screws. Check power supply. 	IPL	Output phase loss	Phase loss at the output side of the inverter, active when 08-10 = 1 (enabled).	<ul style="list-style-type: none"> Wiring loose in inverter output terminal. Motor rated current is less than 10% of the inverter rated current. 	<ul style="list-style-type: none"> Check output wiring / faster screws. Check motor & inverter rating. 	OPL	OH1 Heatsink overheat	The temperature of the heat sink is too high. Note: when OH1 fault occurs three times within five minutes, it is required to wait 10 minutes before resetting the fault.
Low Voltage	DC bus voltage is lower than the UV detection level or the pre-charge contactor is not active while the inverter is running. 200V class: 190Vdc 400V class: 380Vdc The detection value can be adjusted by 07-13).	<ul style="list-style-type: none"> The input voltage is too low. Input phase loss. Acceleration time set too short. Input voltage fluctuation. Pre-charge contactor damaged. DC bus voltage feedback signal value not incorrect. 	<ul style="list-style-type: none"> Check the input voltage. Check input wiring. Increase acceleration time. Check power source Replace pre-charge contactor Replace control board or complete inverter. 																	
LU				Input phase loss	Phase loss at the input side of the inverter or input voltage imbalance, active when 08-09 = 1 (enabled).	<ul style="list-style-type: none"> Wiring loose in inverter input terminal. Momentary power loss. Input voltage imbalance. 	<ul style="list-style-type: none"> Check input wiring / faster screws. Check power supply. 	IPL	Output phase loss	Phase loss at the output side of the inverter, active when 08-10 = 1 (enabled).	<ul style="list-style-type: none"> Wiring loose in inverter output terminal. Motor rated current is less than 10% of the inverter rated current. 	<ul style="list-style-type: none"> Check output wiring / faster screws. Check motor & inverter rating. 	OPL	OH1 Heatsink overheat	The temperature of the heat sink is too high. Note: when OH1 fault occurs three times within five minutes, it is required to wait 10 minutes before resetting the fault.	<ul style="list-style-type: none"> Ambient temperature too high. Cooling fan failed Carrier frequency set too high. Load too heavy. 	<ul style="list-style-type: none"> Install fan or AC to cool surroundings. Replace cooling fan. Reduce carrier frequency. Reduce load / Measure output current 	OH1		
Input phase loss	Phase loss at the input side of the inverter or input voltage imbalance, active when 08-09 = 1 (enabled).	<ul style="list-style-type: none"> Wiring loose in inverter input terminal. Momentary power loss. Input voltage imbalance. 	<ul style="list-style-type: none"> Check input wiring / faster screws. Check power supply. 																	
IPL				Output phase loss	Phase loss at the output side of the inverter, active when 08-10 = 1 (enabled).	<ul style="list-style-type: none"> Wiring loose in inverter output terminal. Motor rated current is less than 10% of the inverter rated current. 	<ul style="list-style-type: none"> Check output wiring / faster screws. Check motor & inverter rating. 	OPL	OH1 Heatsink overheat	The temperature of the heat sink is too high. Note: when OH1 fault occurs three times within five minutes, it is required to wait 10 minutes before resetting the fault.	<ul style="list-style-type: none"> Ambient temperature too high. Cooling fan failed Carrier frequency set too high. Load too heavy. 	<ul style="list-style-type: none"> Install fan or AC to cool surroundings. Replace cooling fan. Reduce carrier frequency. Reduce load / Measure output current 	OH1							
Output phase loss	Phase loss at the output side of the inverter, active when 08-10 = 1 (enabled).	<ul style="list-style-type: none"> Wiring loose in inverter output terminal. Motor rated current is less than 10% of the inverter rated current. 	<ul style="list-style-type: none"> Check output wiring / faster screws. Check motor & inverter rating. 																	
OPL				OH1 Heatsink overheat	The temperature of the heat sink is too high. Note: when OH1 fault occurs three times within five minutes, it is required to wait 10 minutes before resetting the fault.	<ul style="list-style-type: none"> Ambient temperature too high. Cooling fan failed Carrier frequency set too high. Load too heavy. 	<ul style="list-style-type: none"> Install fan or AC to cool surroundings. Replace cooling fan. Reduce carrier frequency. Reduce load / Measure output current 	OH1												
OH1 Heatsink overheat	The temperature of the heat sink is too high. Note: when OH1 fault occurs three times within five minutes, it is required to wait 10 minutes before resetting the fault.	<ul style="list-style-type: none"> Ambient temperature too high. Cooling fan failed Carrier frequency set too high. Load too heavy. 	<ul style="list-style-type: none"> Install fan or AC to cool surroundings. Replace cooling fan. Reduce carrier frequency. Reduce load / Measure output current 																	
OH1																				

LED display	Description	Cause	Possible solutions
OH4 Motor overheating	<ul style="list-style-type: none"> Motor overheating The input of PTC (Positive Temperature Coefficient) exceeds the overheat protection level. 	<ul style="list-style-type: none"> The surrounding temperature of motor is too high. The input of PTC (Positive Temperature Coefficient) exceeds the overheat protection level. (08-42) 	<ul style="list-style-type: none"> Check the surrounding temperature of motor. Check the MT and GND terminal wiring be correct.
0H4			
OL1 Motor overload	Internal motor overload protection tripped, active when protection curve 08-05 = xxx1.	<ul style="list-style-type: none"> Voltage setting V/F mode too high, resulting in over-excitation of the motor. Motor rated current (02-01) set incorrectly. Load too heavy. 	<ul style="list-style-type: none"> Check V/f curve. Check motor rated current Check and reduce motor load, check and operation duty cycle.
0L1			
OL2 Inverter overload	Inverter thermal overload protection tripped. If an inverter overload occurs 4 times in five minutes, it is required to wait 4 minutes before resetting the fault.	<ul style="list-style-type: none"> Voltage setting V/F mode too high, resulting in over-excitation of the motor. Inverter rating too small. Load too heavy. 	<ul style="list-style-type: none"> Check V/f curve. Replace inverter with larger rating. Check and reduce motor load, check and operation duty cycle.
0L2			
OT Over torque detection	Inverter output torque is higher than 08-15 (over torque detection level) for the time specified in 08-16. Parameter 08-14 = 0 to activate.	<ul style="list-style-type: none"> Load too heavy. 	<ul style="list-style-type: none"> Check over torque detection parameters (08-15 / 08-16). Check and reduce motor load, check and operation duty cycle.
0E			
Comm. Error	No Modbus communication received in for the time specified in 09-06 (communication error detection time). Active when 09-07(= 0 to 2).	<ul style="list-style-type: none"> Connection lost or wire broken. Host stopped communicating. 	<ul style="list-style-type: none"> Check connection Check host computer / software.
CE			

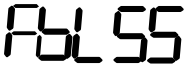
LED display	Description	Cause	Possible solutions
PID Feedback Loss	PID feedback signal falls below level specified in 10-12 (PID feedback loss detection level) for the time specified in 10-13 (Feedback loss detection time). Active when parameter (10-11 = 2).	<ul style="list-style-type: none"> Feedback signal wire broken Feedback sensor broken. 	<ul style="list-style-type: none"> Check feedback wiring Replace feedback sensor.
Fb			
PO Voltage Off	STO terminal 1 error (Without STO/Filter model only)	Terminal board Input SF1 and SG are not connected	Check SF1 and SG connection
PO			
Safety 1 Error	STO terminal 1 error (With STO/Filter model only)	Terminal board Input SF1 and SG are not connected	Check SF1 and SG connection
StO 1			
PO2 Voltage Off	STO terminal 2 error (Without STO/Filter model only)	Terminal board Input SF2 and SG are not connected	Check SF2 and SG connection
PO2			
Safety 2 Error	STO terminal 2 error (With STO/Filter model only)	Terminal board Input SF2 and SG are not connected	Check SF2 and SG connection
StO2			
PO3 Voltage Off	STO terminal 3 error (Without STO/Filter model only)	Transformer voltage output of inverter is not stable.	<ul style="list-style-type: none"> Replace the power board Contact with TECO
PO3			
Safety 3 Error	STO terminal 3 error (With STO/Filter model only)	Transformer voltage output of inverter is not stable.	<ul style="list-style-type: none"> Replace the power board Contact with TECO
StO3			
External fault 0	External fault (Modbus)	Modbus communication 0x2501 bit 2= "1"	<ul style="list-style-type: none"> Reset Modbus communication 0x2501 bit 2= "1"
EFO			

LED display	Description	Cause	Possible solutions
External fault 1 EF1	External Fault (Terminal S1)	External Fault Input Terminal	<ul style="list-style-type: none"> • Check the fault reason • Reset external fault of digital input
External fault 2 EF2	External Fault (Terminal S2)		
External fault 3 EF3	External Fault (Terminal S3)		
External fault 4 EF4	External Fault (Terminal S4)		
External fault 5 EF5	External Fault (Terminal S5)		
External fault 6 EF6	External Fault (Terminal S6)		
Motor control fault CF07	Motor control fault	SLV mode is unable to run motor	<ul style="list-style-type: none"> • Perform rotational or stationary auto-tune • Increase minimum output frequency (01-08)
Motor control fault CF08	Motor control fault	Start or Run fault in PMSLV mode.	<ul style="list-style-type: none"> • Increase the value of 22-10 and 22-23 properly. • Re auto-tune (22-21) • Check if the load is too heavy to raise torque output limit.
Operator Communication Error CF00	Errors of data transmission occur in LCD keypad.	LCD keypad and inverter cannot transmit data after power on 5 seconds.	<ul style="list-style-type: none"> • Disconnect the operator and then reconnect. • Replace the control board

LED display	Description	Cause	Possible solutions
Operator Communication Error 2	Errors of data transmission occur in LCD keypad.	LCD keypad and inverter can transmit data but transmission error occurs for more than 2 seconds	<ul style="list-style-type: none"> • Disconnect the operator and then reconnect. • Replace the control board
			
Operator Disconnection	When 00-02=0, if operator is disconnected during inverter running, the action of operator disconnected will be based on the setting of parameter 16-09.	When 00-02=0, the warning of keypad operator disconnected.	Check the keypad operator connection
			
FBLSS	PID Feedback Signal Loss	<ul style="list-style-type: none"> • Since proportion of loss pressure (23-19) is enabled and over high, the inverter trips to fault. Thus, feedback sensor cannot operate properly or is not installed correctly. 	<ul style="list-style-type: none"> • Check if the proportion of loss pressure (23-19) is set correctly. • Make sure the feedback sensor is installed correctly and PID feedback signal operates normally.
			
Short Circuit	Inverter output short circuit or ground fault.	<ul style="list-style-type: none"> • Short circuit or ground fault (08-23 = 1). • Motor damaged (insulation). • Wire damage or deterioration. 	<ul style="list-style-type: none"> • Check the motor wiring. • Disconnect motor and try running inverter.
			
run Motor1/Motor2 Switch	Motor1/Motor2 switch during operation	Input motor 2 switch command during operation.	Improve the control sequence, motor can be switched in stop.
			
PF Protection Error	<ol style="list-style-type: none"> 1. OH1/OL2 error occurs three times in 5 minutes. 2. Digital input or communication run command not removed 	Digital input or communication runcommand not removed.	Remove the digital input or communication run command.
			
LPBFT	Low pressure fault	<ul style="list-style-type: none"> • The feedback signal is not connected. • Since feedback value of pump pressure is lower than limit of minimum flow. 	<ul style="list-style-type: none"> • Check feedback signal is correct and with connection. • Check if feedback value of pressure is lower than limit of minimum pressure (23-15).
			











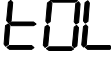











LED display	Description	Cause	Possible solutions
OPBFT	High pressure fault	<ul style="list-style-type: none"> Since feedback value of pump pressure is lower than limit of maximum flow. 	<ul style="list-style-type: none"> Check feedback signal is correct. Check if feedback value of pressure is lower than limit of maximum pressure (23-12).
			
TOL	External Overload (For fire mode only)	<ul style="list-style-type: none"> External Overload signal received by digital input terminal 	<ul style="list-style-type: none"> Check the reason for external overload Reset digital input terminal of external overload
			
FB(Flash)	PID feedback breaking	<ul style="list-style-type: none"> Feedback signal wire broken Feedback sensor broken. 	<ul style="list-style-type: none"> Check feedback wiring Replace feedback sensor.
			



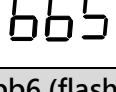
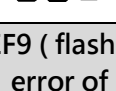



Table 2 Warning/Self-diagnosis and Corrective actions









LED display	Description	Cause	Possible solutions
OV (flash) Over voltage	DC bus voltage exceeds the OV detection level : 200V class : 410Vdc 400V class : 820Vdc (for 400V class, if input voltage 01-14 is set lower than 400V, the OV detection value will be decreased to 700Vdc)	<ul style="list-style-type: none"> Deceleration time set too short, resulting in regenerative energy flowing back from motor to the inverter. The inverter input voltage is too high. Speed search parameters set incorrectly. 	<ul style="list-style-type: none"> Increase deceleration time Reduce input voltage to comply with the input voltage requirements or install an AC line reactor to lower the input voltage. Adjust speed search parameters.
			
UV (flash) under voltage	DC bus voltage is lower than the UV detection level or the pre-charge contactor is not active while the inverter is running. 190Vdc : 200V class; 380Vdc : 400V class (the detection value can be adjusted by 07-13)	<ul style="list-style-type: none"> The input voltage is too low. Input phase loss. DC bus voltage feedback signal value not incorrect. 	<ul style="list-style-type: none"> Check the input voltage. Check input wiring. Replace control board or complete inverter.
			
OH1 (flash) Heatsink overheat	The temperature of the heat sink is too high. Note: when OH1 fault occurs three times within five minutes, it is required to wait 10 minutes before resetting the fault.	<ul style="list-style-type: none"> Ambient temperature too high. Cooling fan failed Carrier frequency set too high. Load too heavy. 	<ul style="list-style-type: none"> Install fan or AC to cool surroundings. Replace cooling fan. Reduce carrier frequency. Reduce load / Measure output current
			









LED display	Description	Cause	Possible solutions
OH3 (flash) Motor over Heating warning	Motor over heating	<ul style="list-style-type: none"> PTC input level is higher than 08-43 	<ul style="list-style-type: none"> Multi-function input function set incorrectly. Check wiring
			
OT (flash) Over torque detection	Inverter output torque is higher than 08-15 (over torque detection level) for the time specified in 08-16. Parameter 08-14 = 0 to activate.	<ul style="list-style-type: none"> Load too heavy. 	<ul style="list-style-type: none"> Check over torque detection parameters (08-15 / 08-16). Check and reduce motor load, check and operation duty cycle.
			
OL1 Motor Overload	Internal motor overload protection tripped, active when protection curve 08-05=xxx1	<ul style="list-style-type: none"> Voltage setting V/F mode too high, resulting in over-excitation of the motor. Motor overload current (02-01) set incorrectly. Motor load too heavy 	<ul style="list-style-type: none"> Check V/F curve. Check motor load current Check and reduce motor load, check and operation duty cycle.
			
OL2 Inverter overload	Inverter thermal overload protection tripped. If an inverter overload occurs 4 times in five minutes, it is required to wait 4 minutes before resetting the fault.	<ul style="list-style-type: none"> Voltage setting V/F mode too high, resulting in over-excitation of the motor. Inverter rating too small. Load too heavy. 	<ul style="list-style-type: none"> Check V/f curve. Replace inverter with larger rating. Check and reduce motor load, check and operation duty cycle.
			
Comm. Error	No Modbus communication received in for the time specified in 09-06 (communication error detection time). Active when 09-07(= 0 to 2).	<ul style="list-style-type: none"> Connection lost or wire broken. Host stopped communicating. 	<ul style="list-style-type: none"> Check connection Check host computer / software.
			
Retry (flash)	Automatic reset activated, warning is displayed until restart delay time set (07-01) expires.	<ul style="list-style-type: none"> Parameter 07-01 set to a value greater than 0. Parameter 07-02 set to a value greater than 0. 	<ul style="list-style-type: none"> Warning disappears after automatic reset.
			
ES (flash) External Emergency Stop	External emergency stop Enabled.	<ul style="list-style-type: none"> 03-00~03-05 set to 14, and the digital input enabled. 	<ul style="list-style-type: none"> Turn off run command, and remove external emergency stop command.
			

LED display	Description	Cause	Possible solutions
bb1 (flash) External baseblock	External base block (Terminal S1)	Multifunction digital input external baseblock active.	<ul style="list-style-type: none"> • Multi-function input function set incorrectly. • Check wiring
			
bb2 (flash) External baseblock	External base block (Terminal S2)		
			
bb3 (flash) External baseblock	External base block (Terminal S3)		
			
bb4 (flash) External baseblock	External base block (Terminal S4)		
			
bb5 (flash) External baseblock	External base block (Terminal S5)		
			
bb6 (flash) External baseblock	External base block (Terminal S6)		
			
EF9 (flash) error of forward/reve rsal rotation	Forward run and reverse run are active within 0.5 sec of each other. Stop method set by parameter 07-09.	Forward run and reverse run active (see 2-wire control).	Check run command wiring
			

LED display	Description	Cause	Possible solutions
Rang setting error	Parameter setting falls outside the allowed range.	Some parameter ranges are determined by other inverter parameters which could cause an out of range warning when the dependency parameter is adjusted. Example: (1) 02-00>02-01, or 20>02-21 (2) 2.00-12>00-13, (3) 00-07 =1, 00-05=00-06 (4) 02-03>02-06 or 02-22>02-25 (5) 20-16<20-15	Check parameter setting.
			
Digital input terminal error	Multi-function input setting error.	Multi-function digital input terminals (03-00 to 03-05) are set to the same function (not including ext. fault and not used.) or : (1) UP/DOWN commands are not set at the same time(they must be used together). (2) UP/DOWN commands (08 and 09) and ACC/DEC commands (11) are set at the same time. (3) Speed search 1(19 · maximum frequency) and Speed search 2 (34 · from the set frequency) are set at the same time. (4) 03-00~03-05 set two-wire and three-wire in the same time.	Check multi-function input setting.
			
V/f curve error	V/f curve setting error.	<ul style="list-style-type: none"> V/F curve setting error. (1) 01-02(Fmax) > 01-12 (Fbase) > 01-06 (Fmid1) 01-08(Fmin) (2) 01-16(Fmax2) > 01-24(Fbase2) > 01-20(Fmid1) > 01-22(Fmin2) 	Check V/F parameters
			
PID selection error	PID selection error.	<ul style="list-style-type: none"> 10-00 and 10-01 set to 1(AI1) or set to 2(AI2) When 23-05=0 and 10-33 >= 1000 or 10-34 ≠ 1. 	<ul style="list-style-type: none"> Check 10-00 and 10-01 Check 10-33,10-34, 23-05.
			
Model selection error	Inverter capacity setting error: Inverter capacity setting 13-00 does not match the rated voltage.	Inverter capacity setting does not match voltage class (13-00).	Check inverter capacity setting 13-00.
Over current protection level B	Inverter current reaches the current protection level B.	<ul style="list-style-type: none"> Inverter current too high. Load too heavy. 	Check load and duty cycle operation.
			

LED display	Description	Cause	Possible solutions
EF1 (flash) External fault (S1)	External fault (Terminal S1) Active when 03-00=25, and Inverter external fault selection 08-24=2.	Multifunction digital input external fault active and parameter 08-24=2 for operation to continue.	<ul style="list-style-type: none"> • Multi-function input function set incorrectly. • Check wiring • Multi-function input function set incorrectly. • Check wiring
			
EF2 (flash) External fault (S2)	External fault (Terminal S2) Active when 03-01=25, and Inverter external fault selection 08-24=2.		
			
EF3 (flash) External fault (S3)	External fault (Terminal S3) Active when 03-02=25, and Inverter external fault selection 08-24=2.		
			
EF4 (flash) External fault (S4)	External fault (Terminal S4) Active when 03-03=25, and Inverter external fault selection 08-24=2.		
			
EF5 (flash) External fault (S5)	External fault (Terminal S5) Active when 03-04=25, and Inverter external fault selection 08-24=2.		
			
EF6 (flash) External fault (S6)	External fault (Terminal S6) Active when 03-05=25, and Inverter external fault selection 08-24=2.		
			
PI setting error	Inverter PI setting error	Inverter pulse input selection (03-30) selection conflicts with PID source (10-00 and 10-01).	Check pulse input selection (03-30) and PID source (10-00 and 10-01).
			
FB (flash) PID feedback breaking	PID feedback signal falls below level specified in 10-12 (PID feedback loss)	<ul style="list-style-type: none"> • Feedback signal wire broken • Feedback sensor broken. 	<ul style="list-style-type: none"> • Check feedback wiring • Replace feedback sensor.

LED display	Description	Cause	Possible solutions
	detection level) for the time specified in 10-13 (Feedback loss detection time). Active when parameter (10-11 = 1).		
Fire mode enabled	Fire mode enabled	Fire mode enabled.	Check the environment and confirm the fire status. If no fire, turn off the power and power on again.
			
Parameter setting Error	Parameter setting error	The parameter setting is wrong	Please refer to the manual for correct setting
			
Direct start warning	The inverter can't start directly, due to 07-04=1	Run command from the terminal is enabled and 07-04=1	Remove the run command from the terminal first, and enabled later.
			
External Terminal Stop Error	External Terminal is main run command source selection (00-02=1) and run command executes but executes stop command from keypad.	Run command executes from external terminal but executes stop command from keypad.	Remove the run command from external terminal
			
EEPROM Save Error	The data save in EEPROM is wrong.	<ul style="list-style-type: none"> • EEPROM circuit failure • Parameter check error after power on 	<ul style="list-style-type: none"> • Restore factory setting, then cut off the power and power on again. • If warning again, replace control board.
			
Control Board Error	Firmware can't meet Control board.	Firmware can't meet Control board.	Replace the control board.
			
Wrong Running Direction Error	Running direction is different from 11-00	Check the command among 11-00, jog and DI control to see if any difference.	Revise the command among 11-00, jog and DI control to see if any difference
			
Parameter Lock	Parameter lock key code (password) already locked	Parameter lock key code already enable (13-07)	Lifting the parameter lock key code, to enter the correct parameter for 13-07
			

LED display	Description	Cause	Possible solutions
Set password failed 	Parameter lock key code cannot enable	To enable the parameter lock key code (password) function, but the password is not correct	Enter the correct parameter for 13-07 to enable the parameter lock key
			
Run Command Error 	One direction operation only, inverter can not receive reverse operation command at the same time.	Check the terminal of reverse operation command	Remove the reverse operation command from external terminal
			
ES (flash) External Emergency Stop 	External emergency stop Enabled.	03-00~03-05 set to 14, and the digital input enabled.	Turn off run command, and remove external emergency stop command.
			
Zero Speed Stop Error 	Frequency command is smaller than 01-08 without DC brake.	Frequency command is smaller than motor minimum output frequency.	Adjust frequency command
			

Warning Message (LCD display only)

LCD display	Description	Cause	Possible solutions
Operator Copy Error	Parameters can not upload to operator	Inverter data transmission error, can not upload the data to operator	Check operator and control connection
RDE			
Operator Write Error	Operator can not write data to inverter	<ul style="list-style-type: none"> • The control mode in the operator does not match the inverter. • The model name in the operator does not match the inverter. • The firmware version in the operator does not match the inverter. 	Check the control mode, model name and firmware version of inverter.
WRE			
Operator Compare Error	Data compare incorrect between operator and inverter.	When operator upload or download the data, user can compare the data of operator and inverter, when data of both side does not match, operator will show "VRYE" error.	Check operator and control connection
VRYE			
Does Not Allow to Read and Save Data	Operator can not read or save inverter parameters	When 16-08=0, does not allow to read inverter parameters or save them to the operator.	Check parameter setting of parameter (16-08)
RDP			

5.2 General Troubleshooting

Status	Checking point	Remedy
Motor runs in wrong direction	Is the wiring for the output terminals correct?	Wiring must match U, V, and W terminals of the motor.
	Is the wiring for forward and reverse signals correct?	Check for correct wiring.
The motor speed can not be regulated.	Is the wiring for the analog frequency inputs correct?	Check for correct wiring.
	Is the setting of operation mode correct?	Check the Frequency Source set in parameters 00-05/00-06.
	Is the load too excessive?	Reduce the load.
Motor running speed too high or too low	Check the motor specifications (poles, voltage...) correct?	Confirm the motor specifications.
	Is the gear ratio correct?	Confirm the gear ratio.
	Is the setting of the highest output frequency correct?	Confirm the highest output frequency
Motor speed varies unusually	Is the load too excessive?	Reduce the load.
	Does the load vary excessively?	(1) Minimize the variation of the load. (2) Consider increasing the capacities of the inverter and the motor.
	Is the input power erratic or is there a phase loss ?	(1) Consider adding an AC reactor at the power input side if using single-phase power. (2) Check wiring if using three-phase power.
Motor can not run	Is the power connected to the correct L1(L), L2, and L3(N) terminals? is the charging indicator lit ?	(1) Is the power applied ? (2) Turn the power OFF and then ON again. (3) Make sure the power voltage is correct. Make sure screws are secured firmly.
	Is there voltage across the output terminals T1, T2, and T3?	Turn the power OFF and then ON again.
	Is overload causing the motor to stall?	Reduce the load so the motor will run.
	Are there any abnormalities in the inverter?	See error descriptions to check wiring and correct if necessary.
	Is there a forward or reverse run command ?	
	Has the analog frequency signal been input?	(1) Is analog frequency input signal wiring correct? (2) Is voltage of frequency input correct?
	Is the operation mode setting correct?	Operate through the digital keypad

5.3 Troubleshooting of the Inverter

5.3.1 Quick troubleshooting of inverter

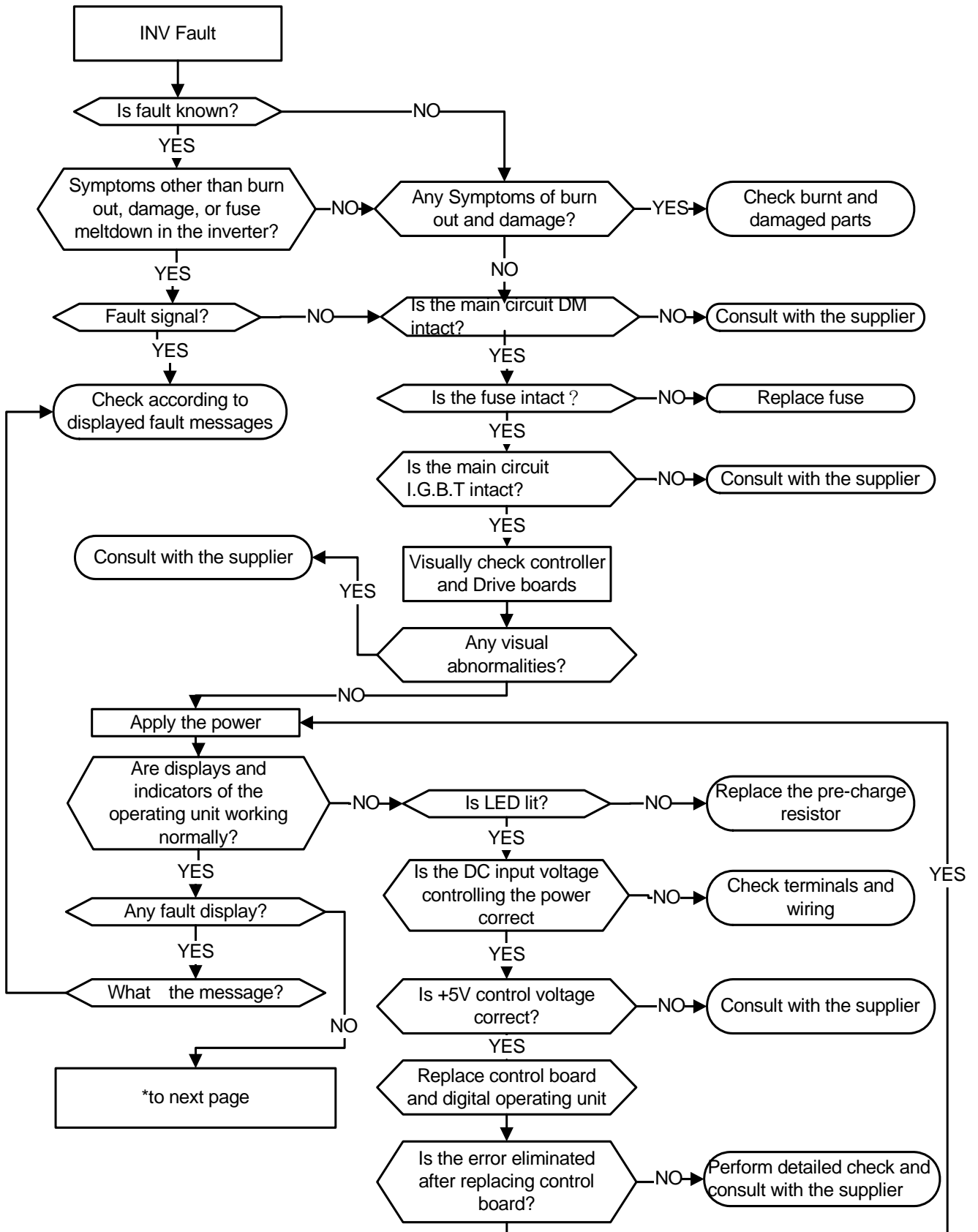

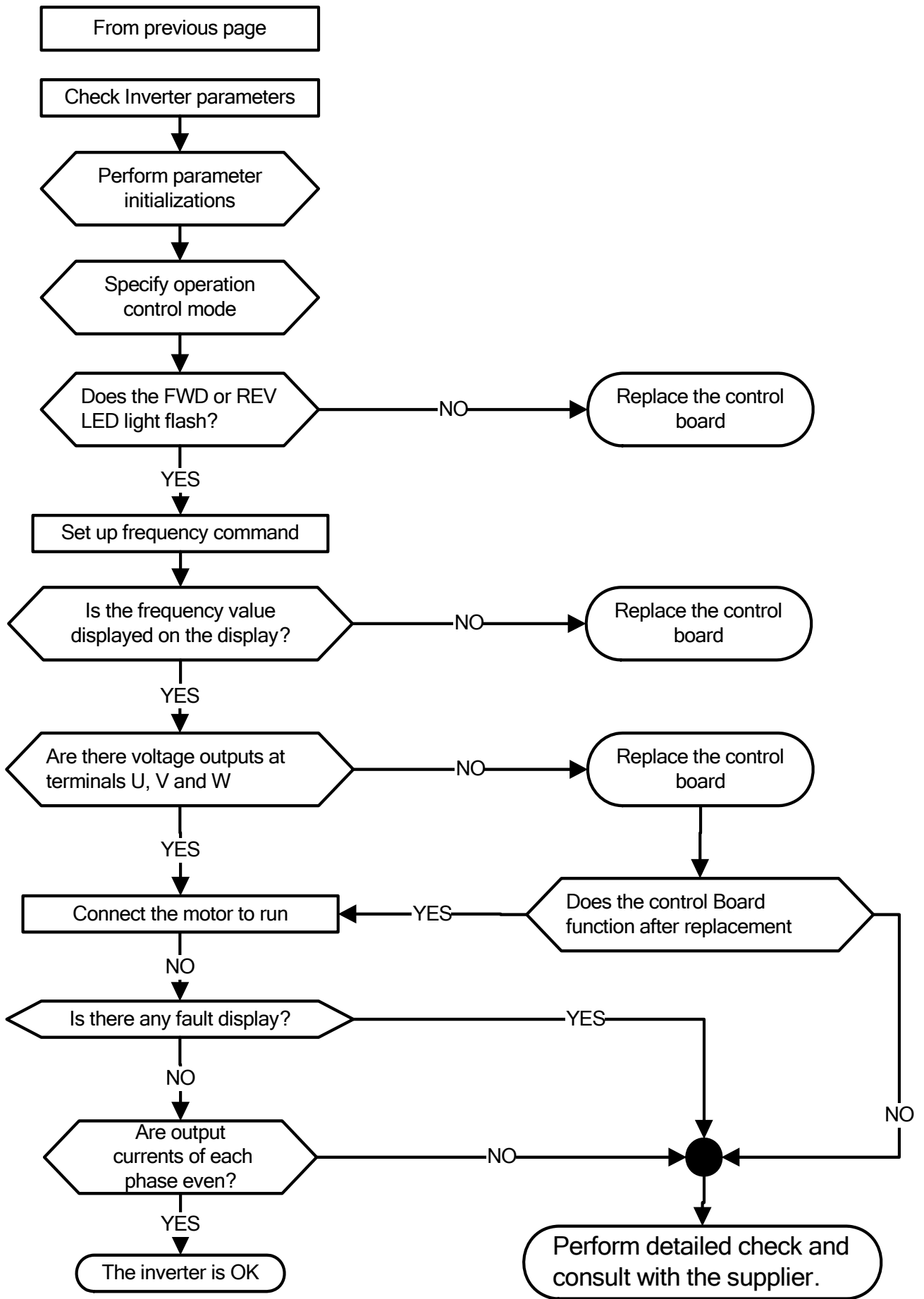

5.3.2 Troubleshooting for OC、OL error display

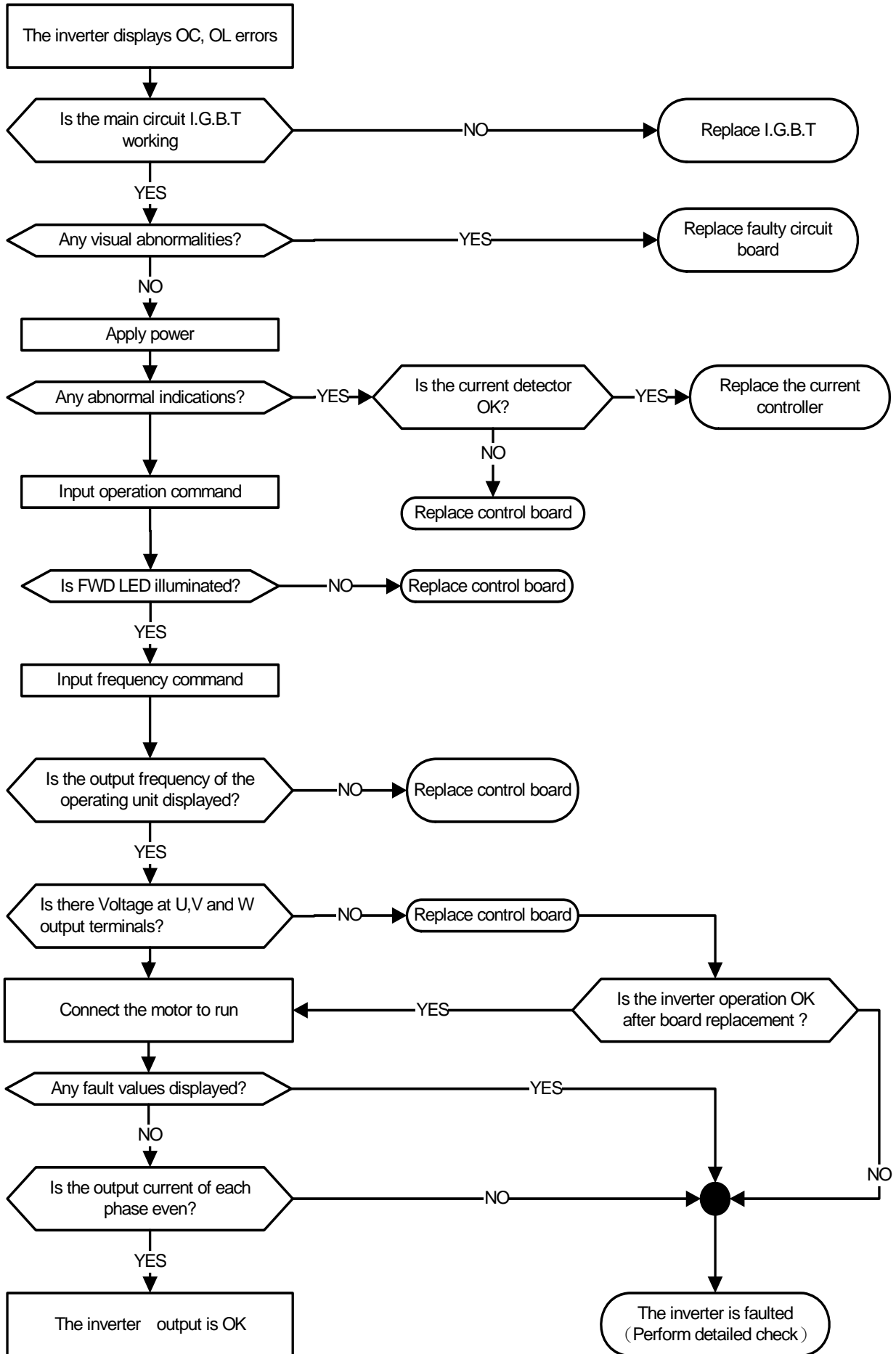

5.3.3 Troubleshooting for OV, LV error display

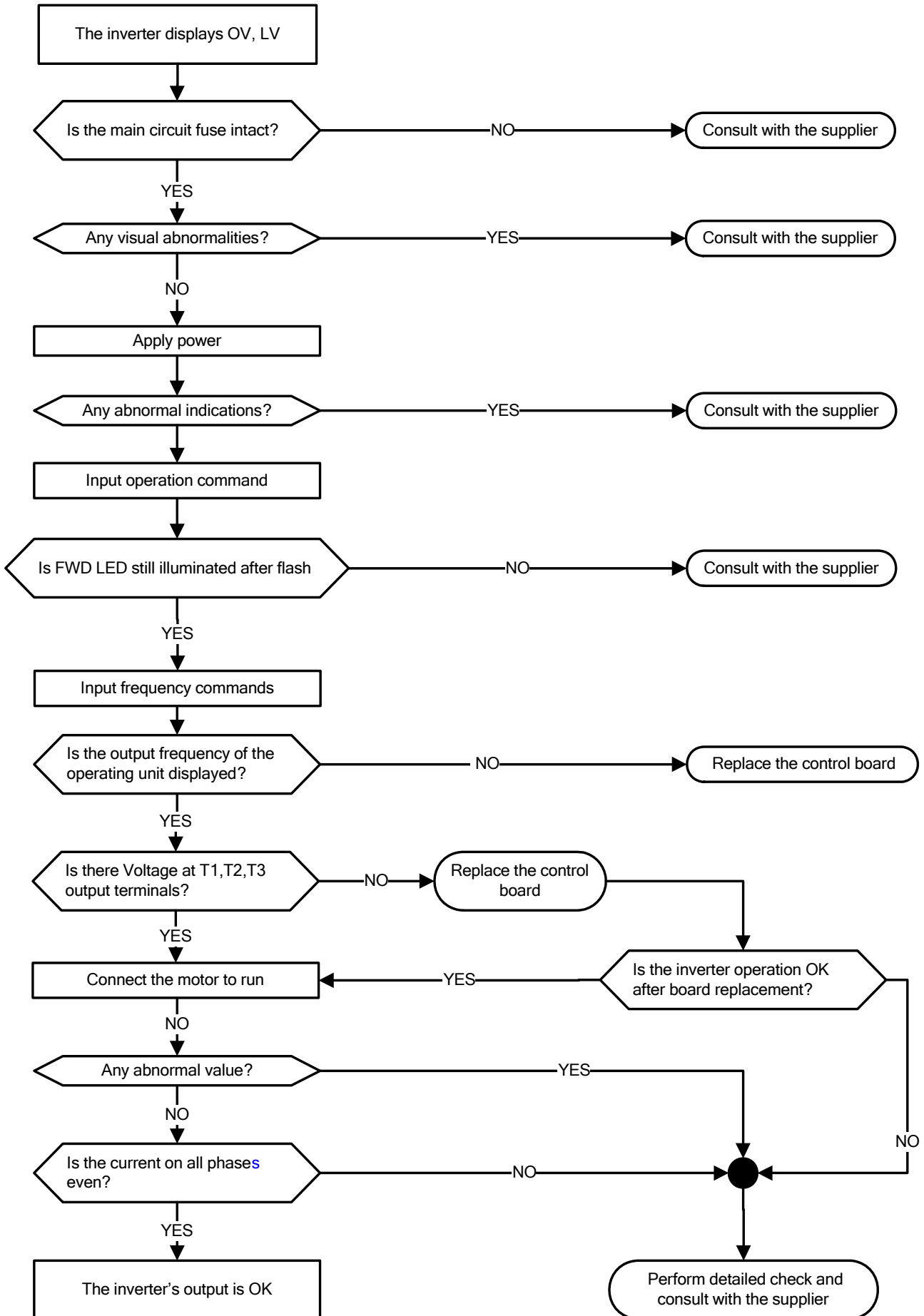

5.3.4 Motor not running

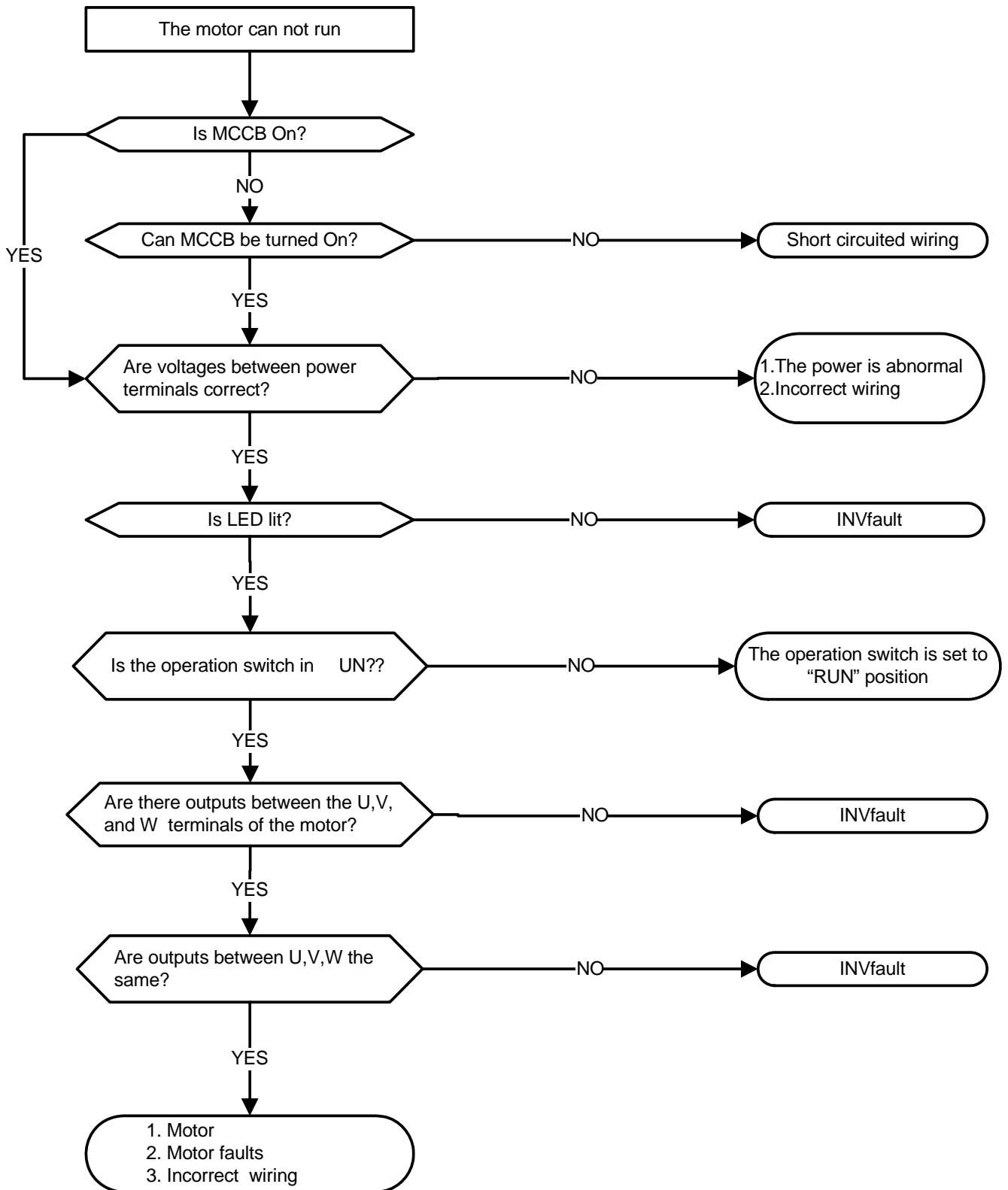

5.3.5 Motor overheating

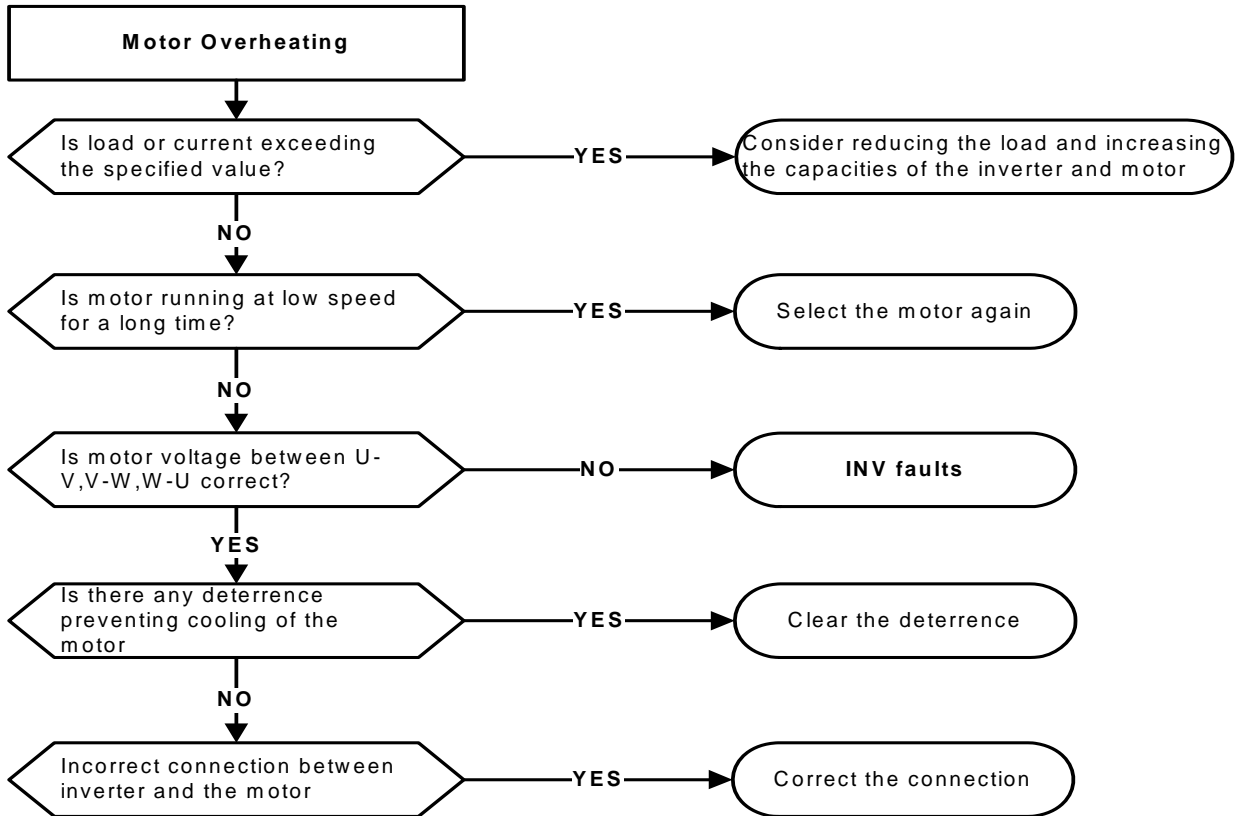

5.3.6 Motor runs unbalanced

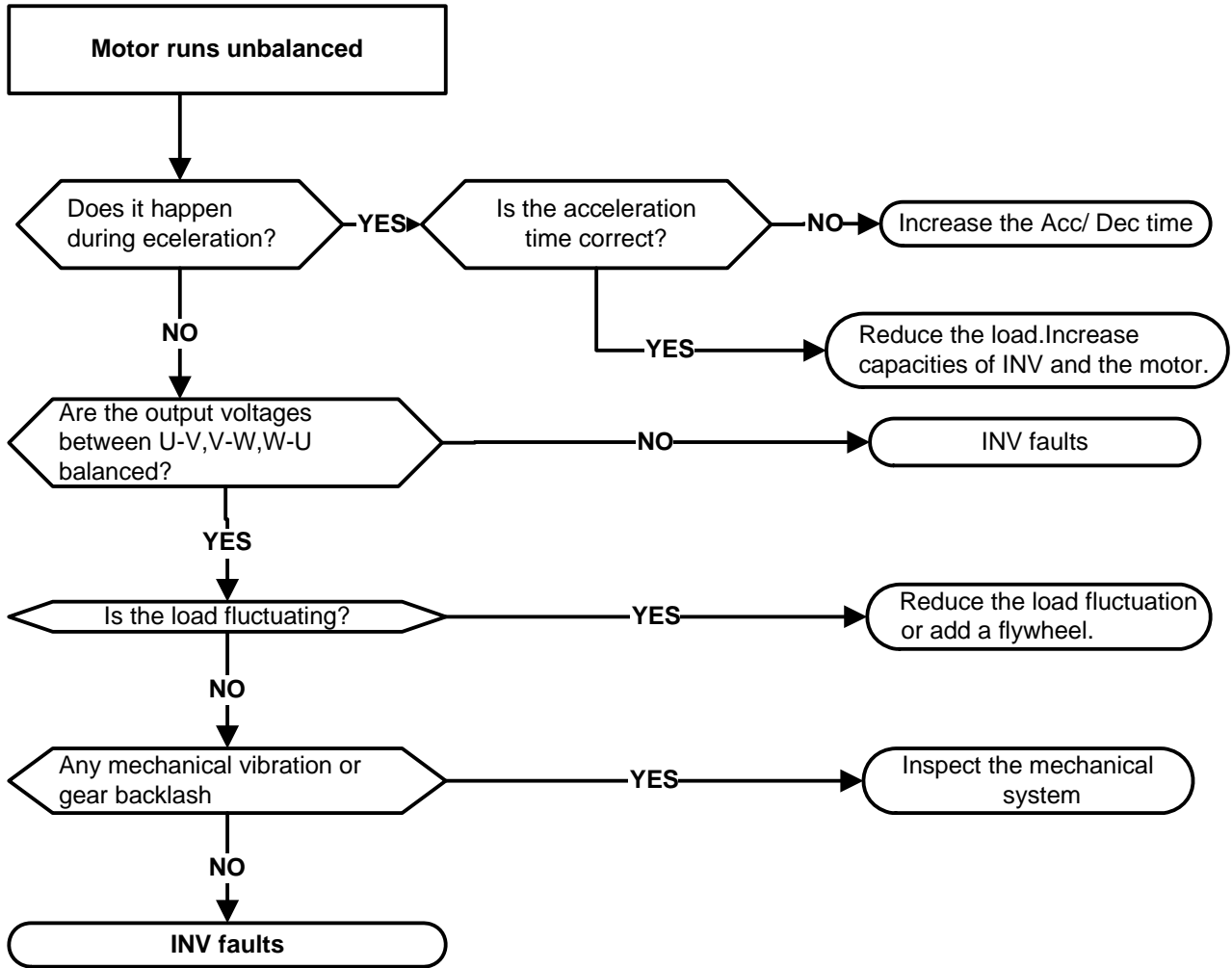

5.3.7 Auto-tuning Error

When a fault occurs during auto-tuning of a standard AC motor, the display will show the "AtErr" fault and the motor stops. The fault information is displayed in parameter 17-11. Refer to Table 10.4.1, for fault information during tuning, cause and corrective action.

Table 3 Auto-tuning fault and corrective actions

Error	Description	Cause	Corrective action
01	Motor data input error.	<ul style="list-style-type: none"> Motor Input data error during auto-tuning. Inverter output current does not match motor rated current. 	<ul style="list-style-type: none"> Check the motor tuning data (17-00 to 17-09). Check inverter capacity
02	Motor lead to lead resistance R1 tuning error.	<ul style="list-style-type: none"> Auto-tuning is not completed within the specified time Auto-tuning results fall outside parameter setting range. Motor rated current exceeded. Motor was disconnected. 	<ul style="list-style-type: none"> Check the motor tuning data (17-00 to 17-09). Check motor connection. Disconnect motor load. Check inverter current detection circuit and DCCTs. Check motor installation.
03	Motor leakage inductance tuning error.		
04	Motor rotor resistance R2 tuning error.		
05	Motor mutual inductance Lm tuning error.		
07	Deadtime compensation detection error		
08	Motor acceleration error (Rotational type auto-tuning only).	<ul style="list-style-type: none"> Motor fails to accelerate in the specified time (00-14= 20sec). 	<ul style="list-style-type: none"> Increase acceleration time (00-14). Disconnect motor load.
09	Other auto-tuning errors	<ul style="list-style-type: none"> No load current is higher than 70% of the motor rated current. Torque reference exceeds 100%. Errors other than ATE01~ATE08. 	<ul style="list-style-type: none"> Check the motor tuning data (17-00 to 17-09). Check motor connection.

5.3.8 PM Motor Auto-tuning Error

When a fault occurs during auto-tuning of a PM motor, the display will show the "IPErr" fault and the motor stops. The fault information is displayed in parameter 22-22. Refer to Table 4 for fault information during tuning, cause and corrective action.

Table 4 Auto-tuning fault and corrective actions for PM motor

Error	Description	Cause	Corrective action
01	Magnetic pole alignment tuning failure (static).	Inverter output current does not match motor current.	<ul style="list-style-type: none"> Check parameter 22-02 Check inverter capacity
05	Circuit tuning time out.	System abnormality during circuit tuning.	<ul style="list-style-type: none"> Check for active protection functions preventing auto-tuning.
07	Other motor tuning errors.	Other tuning errors.	<ul style="list-style-type: none"> Check parameter 22-02 Check motor connection.
09	Current out of range during circuit tuning.	Inverter output current does not match motor current.	<ul style="list-style-type: none"> Check parameter 22-02 Check inverter capacity

5.4 Routine and periodic inspection

To ensure stable and safe operation, check and maintain the inverter at regular intervals. Use the checklist below to carry out inspection.

Disconnect power after approximately 5 minutes to make sure no voltage is present on the output terminals before any inspection or maintenance.

Items	Details	Checking period		Methods	Criteria	Remedies
		Daily	1Year			
Environment & Ground connection						
Ambient conditions at the installation	Confirm the temperature and humidity at the machine	☉		Measure with thermometer and hygrometer	Temperature: -10~40°C (14-120°F) Humidity : Below 95%RH	Improve the ambient or relocate the drive to a better area.
	Are there inflammable materials in the vicinity?	☉		Visual check	Keep area clear	
Installation Grounding	Any unusual vibration from the machine	☉		Visual, hearing check	Keep area clear	Secure screws
	Is the grounding resistance correct?		☉	Measure the resistance with a multi-tester	200Vclass : below 100Ω	Improve the grounding if needed.
Terminals & Wiring						
Connection terminals	Any loose parts or terminals?		☉	Visual check Check with a screwdriver	Correct installation requirement	Secure terminals and remove rust
	Any damage to the base ?		☉			
	Any corroded Terminals?		☉			
Wiring	Any broken wires?		☉	Visual check	Correct wiring requirement	Rectify as necessary
	Any damage to the wire insulation?		☉			
Voltage						
Input power voltage	Is the voltage of the main circuit correct?	☉		Measure the voltage with a multi-tester	Voltage must conform with the spec.	Improve input voltage if necessary.
Circuit boards and components						
Printed circuit board	Any contamination or damage to printed circuit board?		☉	Visual check	Correct component condition	Clean or replace the circuit board
	Discolored, overheated, or burned parts		☉			
Capacitor	Any unusual odor or leakage	☉				
	Any physical damage or		☉			

Items	Details	Checking period		Methods	Criteria	Remedies
		Daily	1Year			
	protrusion					
Power component	Any dust or debris		☉			Clean components
	Check resistance between each terminals		☉	Measure with a multi-tester	No short circuit or broken circuit in three-phase output	Consult with the supplier
Peripheral device						
Rheostat	Whether rheostat wiring or connector are damaged		☉	Visual check	No abnormalities	Replacement rheostat
Electromagnetic Contactor	Check contacts and connections for any abnormality.	☉				Replacement Contactor
	Unusual vibration and noise	☉		hearing check		
Reactor	Is there any abnormalities?	☉		Visual check	Replacement Reactor	
Cooling System						
Cooling fan	Unusual vibration and noise		☉	Visual or hearing check	Correct cooling	Consult with the supplier
	Excessive dust or debris	☉		Visual check		Clean the fan
Heat sink	Excessive dust or debris	☉				Clean up debris or dust
Ventilation Path	Is the ventilation path blocked?	☉				Clear the path

5.5 Maintenance

To ensure long-term reliability, follow the instructions below to perform regular inspection. Turn the power off and wait for a minimum of 5 minutes before inspection to avoid potential shock hazard from the charge stored in high-capacity capacitors.

1. Maintenance Check List :

- Ensure that temperature and humidity around the inverters is as required in the instruction manual, installed away from any sources of heat and the correct ventilation is provided..
- For replacement of a failed or damaged inverter consult with the local supplier.
- Ensure that the installation area is free from dust and any other contamination.
- Check and ensure that the ground connections are secure and correct.
- Terminal screws must be tight, especially on the power input and output of the inverter.
- **Do not perform any insulation test on the control circuit.**

2. Insulation test Method

Single Phase :

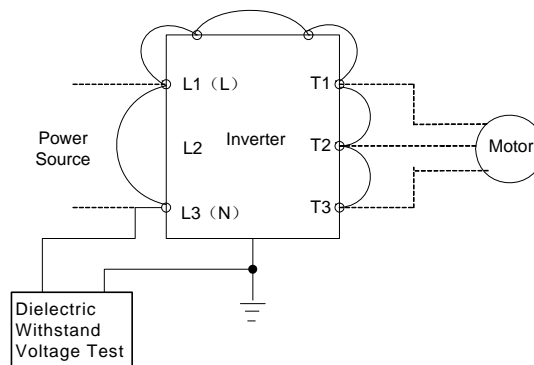

Three Phase :

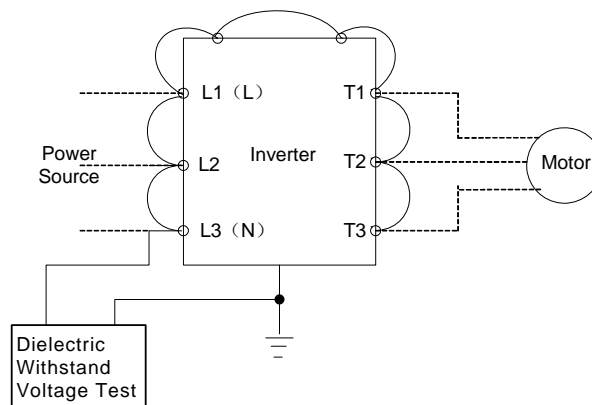

Chapter 6 Peripherals Components

6.1 Reactor specifications

Model : E510-□□□ -SXXX	Specification	
	Current (A)	Calculated Inductance Based on 3% Reactance (mH)
2P5	8.5	2.1
201	12	2.1
202	19.0	1.1
203	25.0	0.71
205	20	0.53
208	33.0	0.35
210	42.0	0.265
215	60	0.18
220	80	0.13
225	95	0.13
230	140	0.09
240	170	0.07
401	4.5	8.4
402	6	4.2
403	7.5	3.6
405	12	2.2
408	17.0	1.42
410	23.0	1.06
415	31.0	0.7
420	40	0.53
425	50	0.42
430	70	0.35
440	90	0.28
450	110	0.23
460	130	0.20
475	180	0.14

6.2 Electromagnetic contactor circuit breaker

Model : E510-□□□ -SXXX	Circuit breaker made by TECO	Magnetic contactor made by TECO
2P5	TO-50E 15A	CN-11
201/202	TO-50E 20A	
203/205	TO-50E 30A	
208	TO-50E 50A	CN-18
210	TO-100E 60A	CN-25
215	TO-100E 100A	CN-50
220		CN-60
225	TO-225S (100A)	CU-80
230	TO-225S (150A)	CN-100
240	TO-225S(175A)	CN-125
401/402/403/405	TO-50EC 15A	CN-11
408	TO-50EC 20A	CN-16
410	TO-50EC 30A	CN-18
415	TO-50EC 50A	CN-25
420	TO-100EB 50A	CN-35
425	TO-100EB 75A	CN-50
430	TO-100S(75A)	CU-50
440	TO-100S(100A)	CU-65
450		CU-80
460	TO-225S(150A)	CN-100
475	TO-225S(175A)	CN-125

6.3 Fuse specification

Model : E510-□□□ -SXXX	Fuse Type
2P5/201	15A, 300VAC
202/203/205	30A, 300VAC
208/210	60A, 300VAC
215/220	100A, 300VAC
225	200A, 300VAC
230	250A, 300VAC
240	300A, 300VAC
401	5 A, 600VAC
402	10A, 600VAC
403	15A, 600VAC
405	20A, 600VAC
408/410	40A, 600VAC
415/420	70A, 600VAC
425	100A, 600VAC
430	120A, 600VAC
440	150A, 600VAC
450	200A, 600VAC
460	250A, 600VAC
475	300A, 600VAC

6.4 Fuse specification (UL model recommended)

Model	Manufacture	Type	Rating
E510-2P5/201-SH1(F)	Bussmann	20CT	690V 20A
E510-202-SH1(F)		30FE	690V 30A
E510-203-SH1(F)		50FE	690V 50A
E510-2P5/201-SH3		20CT	690V 20A
E510-202-SH3		20CT	690V 20A
E510-203-SH3		30FE	690V 30A
E510-205-SH3		50FE	690V 50A
E510-208-SH3		63FE	690V 63A
E510-210-SH3	Ferraz Shawmut	A50QS100-4	500V 100A
E510-215-SH3	Bussmann or Ferraz Shawmut	120FEE A50QS150-4	690V 120A 500V 150A
E510-220-SH3	Ferraz Shawmut	A50QS150-4	500V 150A
E510-225-SH3	-	-	500V 200A
E510-230-SH3	-	-	500V 250A
E510-240-SH3	-	-	500V 300A
E510-401-SH3(F)	Bussmann	10CT	690V 10A
E510-402/403-SH3(F)		16CT	690V 16A
E510-405-SH3(F)		25ET	690V 25A
E510-408-SH3(F)		40FE	690V 40A
E510-410-SH3(F)		50FE	690V 50A
E510-415-SH3(F)		63FE	690V 63A
E510-420-SH3(F)		80FE	690V 80A
E510-425-SH3(F)	Ferraz Shawmut	A50QS100-4	500V 100A
E510-430-SH3(F)	-	-	690V 120A
E510-440-SH3(F)	-	-	690V 150A
E510-450-SH3(F)	-	-	690V 200A
E510-460-SH3(F)	-	-	690V 250A
E510-475-SH3(F)	-	-	690V 300A

6.5 Brake resistor

Model			Braking Unit		Specifications of Braking Resistor				Dimension of Braking Resistor		Braking Torque	Minimum Resistance	
V	HP	KW	Model	Qty	Number of Braking Resistor	Qty	(W)	(Ω)	(LxWxH) mm	Qty	10% ED	(Ω)	(W)
220V 1/3Ph	0.5	0.4	-	-	JNBR-150W400	1	150	400	150W/400Ω (251x28x60)	1	119	50	350
	1	0.75	-	-	JNBR-150W200	1	150	200	150W/200Ω (251x28x60)	1	119	50	350
	2	1.5	-	-	JNBR-150W100	1	150	100	150W/100Ω (251x28x60)	1	119	50	350
	3	2.2	-	-	JNBR-260W70	1	260	70	260W/70Ω (274x40x78)	1	115	50	350
220V 3Ph	5	4	-	-	JNBR-390W40	1	390	40	390W/40Ω (395x40x78)	1	119	19	1000
	7.5	5.5	-	-	JNBR-520W30	1	520	30	520W/30Ω (400x50x100)	1	108	10	1600
	10	7.5	-	-	JNBR-780W20	1	780	20	780W/20Ω (400x50x100)	1	119	10	1600
	15	11	-	-	JNBR-2R4KW13R6	1	2400	13.6	2400W/13.6Ω (400x50x100)	2	117	10	1600
	20	15	-	-	JNBR-3KW10	1	3000	10	1500W/20Ω (615x60x110)	2	119	6.6	2400
	25	18.5	-	-	JNBR-4R8KW8	1	4800	8	1200W/32Ω (535x60x110)	4	119	6.6	2400
	30	22	JNTBU-230	1	JNBR-4R8KW6R8	1	4800	6.8	1200W/27.2Ω (535x60x110)	4	117	5.5	3000
	40	30	JNTBU-230	2	JNBR-3KW10	2	3000	10	1500W/20Ω (615x60x110)	4	119	5.5	3000
400V 3Ph	1	0.75	-	-	JNBR-150W750	1	150	750	150W/750Ω (251x28x60)	1	126	125	600
	2	1.5	-	-	JNBR-150W400	1	150	400	150W/400Ω (251x28x60)	1	119	125	600
	3	2.2	-	-	JNBR-260W250	1	260	250	260W/250Ω (274x40x78)	1	126	84	800
	5	4	-	-	JNBR-400W150	1	400	150	400W/150Ω (395x40x78)	1	126	56	1200
	7.5	5.5	-	-	JNBR-600W130	1	600	120	600W/130Ω (395x40x78)	1	102	67	1000
	10	7.5	-	-	JNBR-800W100	1	800	100	800W/100Ω (535x60x110)	1	99	67	1000
	15	11	-	-	JNBR-1R6KW50	1	1600	50	1600W/50Ω (615x60x110)	1	126	25	2500

Model			Braking Unit		Specifications of Braking Resistor				Dimension of Braking Resistor		Braking Torque	Minimum Resistance	
V	HP	KW	Model	Qty	Number of Braking Resistor	Qty	(W)	(Ω)	(LxWxH) mm	Qty	10% ED	(Ω)	(W)
	20	15	-	-	JNBR-1R5KW40	1	1500	40	1500W/40Ω (615x60x110)	1	119	20	3200
	25	18.5	-	-	JNBR-4R8KW32	1	4800	32	1200W/32Ω (535x60x110)	4	117	20	3200
	30	22	-	-	JNBR-4R8KW27R2	1	4800	27.2	1200W/27.2Ω (535x60x110)	4	117	20	3200
	40	30	-	-	JNBR-6KW20	1	6000	20	1500W/20Ω (615x60x110)	4	119	10	6200
	50	37	TBU-430	2	JNBR-4R8KW32	2	4800	32	1200W/32Ω (535x60x110)	8	119	19.2	3600
	60	45	TBU-430	2	JNBR-4R8KW27R2	2	4800	27.2	1200W/27.2Ω (535x60x110)	8	117	19.2	3600
	75	55	TBU-430	2	JNBR-6KW20	2	6000	20	1500W/20Ω (615x60x110)	8	126	19.2	3600

Note :

Formula for brake resistor : $W = (V_{pnb} * V_{pnb}) * ED\% / R_{min}$

- (1) **W** : braking resistor power (Watts)
- (2) **V_{pnb}** : braking voltage (220V=380VDC, 440V=760VDC)
- (3) **ED%** : braking effective period
- (4) **R_{min}** : braking resistor minimum value (ohms)

6.6 Input noise filter

Install a noise filter on power supply side to eliminate noise transmitted between the power line and the inverter. The inverter noise filter shown in table below meets the EN61800-5-1.

Frame	Model	Input Voltage	External Number of Filter	(A)
1	2P5/201-SH	1Φ/3Φ 200~240V	E2F-2102/FN3258-16-45	10/16
2	202/203-SH1(F)		FS6146-27-07/FN3258-16-45	27/16
1	202-SH3	3Φ 200~240V	FN3258-16-45	16
2	205-SH3		FS20500-22-99	22
3	208/210-SH3		T-096.05001.00	50
4	215/220-SH3		T-097.08004.00	80
5	225-SH3		FS32125-86-99	86
6	230/240-SH3		FS32125-150-99	150
1	401/402-SH3(F)	3Φ 380~480V	FN3258-16-45	16
2	403/405-SH3(F)		T-097.08004.00	80
3	408/410/415-SH3(F)		FS42500-50-99	80
4	420/425-SH3(F)		JN5-FLT-63A	63
5	430-SH3(F)		JN5-FLT-112A	112
6	440/450/460-SH3(F)		FS32126-181-99	181
6	475-SH3(F)			

6.7 Accessories

Accessories	Instruction	Model	Note
Connection cable	Operator extension cable	JN5-CM-01M	1m
		JN5-CM-02M	2m
		JN5-CM-03M	3m
		JN5-CM-05M	5m
	RJ45 to USB connecting cable	JN5-CM-USB	1.8m
Dust Sticker (For remote keypad)	If remote keypad function is necessary, please stick the dust sticker, to prevent dust enter	4KA92X2253	For Frame 1~4
		4KA92X1936	For Frame 5
		4KA92X1937	For Frame 6
NEMA1 kits	NEMA1 kit can upgrade the protection level of inverter, it can be installed at the bottom of inverter. (Frame5/6 already built-in NEMA 1 design)	JN5-NK-SE01	For Frame 1
		JN5-NK-SE02	For Frame 2
		JN5-NK-SE03	For Frame 3
		JN5-NK-SE04	For Frame 4
Copy Unit	Copy the inverter parameters to another inverter by copy unit. (Support E510s series after v1.4firmware)	JN5-CU	
LCD Operator	IP20 LCD Operator	JN5-OP-A02	
	LCD remote keypad panel base	4KA82X880	
Remote Keypad Panel Base	For remote keypad to be mounted on the panel more easily	JN5-KEYBOX	
Communication Card	Profibus communication card	JN5-CMI-PDP	Integrated Type
	TCP-IP communication card	JN5-CMI-TCPIP	
	DeviceNet communication card	JN5-CMI-DNET	
	CANopen communication card	JN5-CMI-CAN	
Dust Sticker (TOP)	The options can upgrade the protection level to avoid the entry of foreign matter. (When inverter installed with dust sticker, please does not exceed 70% rated current of inverter)	4KA92X1944	For frame 1
		4KA92X1945	For frame 2
		4KA92X1946	For frame 3
		4KA92X1947	For frame 4
Din-rail kit	The options can fixed the drive on 35mm din-rail.	JN5-DIN01	For frame 1
		JN5-DIN02	For frame 2

Din-rail kit model: Including sheet metal base and plastic base, fixed with screws.



JN5-DINF1

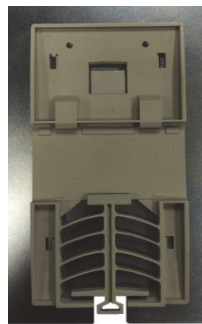

JN5-DINF2

(1) Blank cover and operator extension cable

- When used for remote control purposes, the keypad can be removed and remotely connected with an extension cable (figure a).
- If inverter controlled by remote keypad, please put the dust sticker on the position of display to prevent the foreign material fall into inverter (figure b).

Dust Sticker For remote keypad

Corresponding frame	Model
Frame 1~4	4KA92X2253
Frame 5	4KA92X1936
Frame 6	4KA92X1937

- Extension cables are available in the following length.

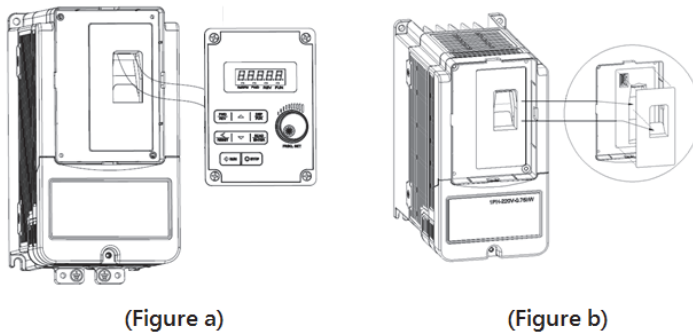

Name	Model	Specification
Operator extension cable	JN5-CB-01M	1m (3.3 ft)
	JN5-CB-02M	2m (6.6 ft)
	JN5-CB-03M	3m (10 ft)
	JN5-CB-05M	5m (16.4 ft)

(2) RJ45 to USB connecting cable (1.8m)

- JN5-CM-USB has the function of converting USB communication format to RS485 to achieve the inverter communication control being similar with PC or other control equipment with USB port.
- Exterior :

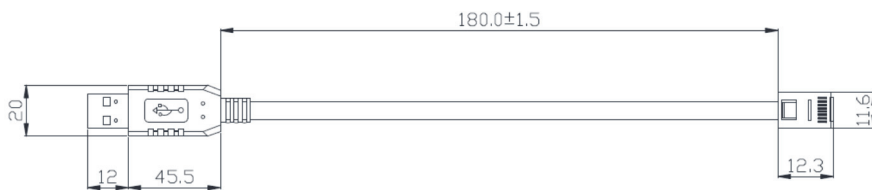

- Connecting :

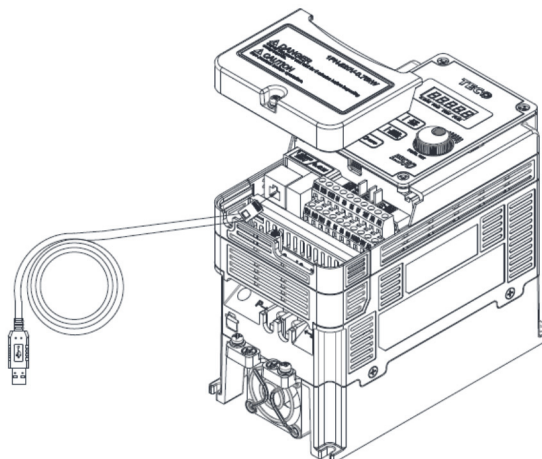

(3) NEMA1 option

- Inverter can reach NEMA1 protection level when NEMA1 options installed.

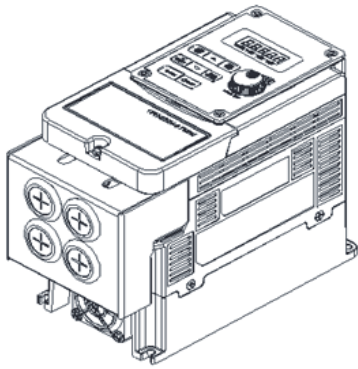

Name	Model	Note	Weight (Kg)
NEMA1 options	JN5-NK-SE01	For frame 1 models	0.24
	JN5-NK-SE02	For frame 2 models	0.27
	JN5-NK-SE03	For frame 3 models	0.45
	JN5-NK-SE04	For frame 4 models	0.56

*Frame 5/6 models already built-in NEMA1 design

(4) Copy unit (JN5-CU)(Copy unit can be used on E510s with v1.4 and above)

- Parameters can be copied from one inverter to other inverters.

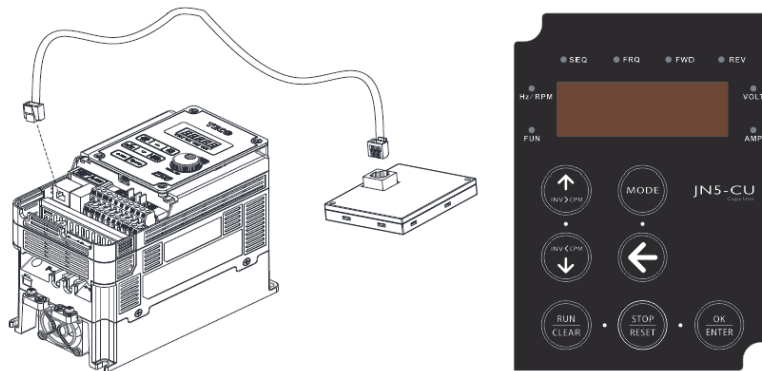

- Installation dimensions of copy unit (unit : mm)

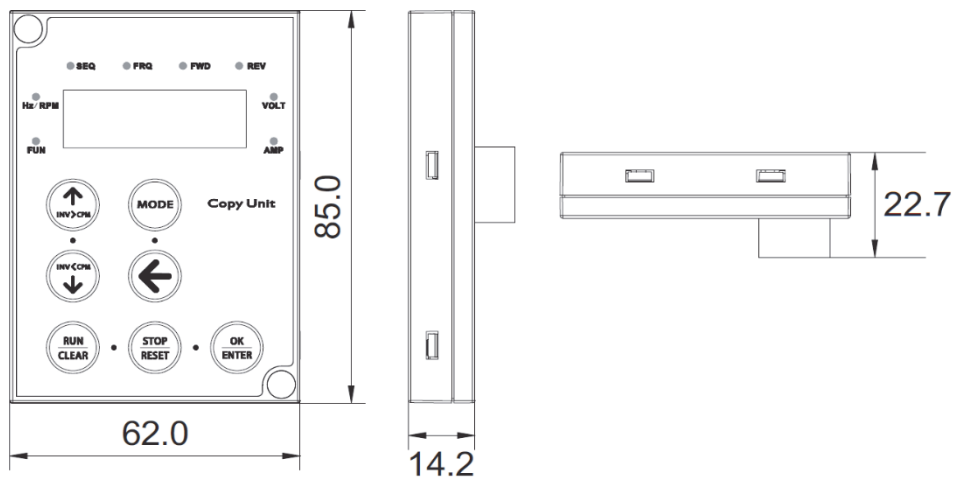

➤ Connection Conditions of Copy Unit (JN5-CU)

Inverter	Keypad Parameters	Motor Parameters	NOTE
Same Series Inverter Same HorsePower	Can be Copied	Can be Copied	Old version parameters can be copied to New version
Same Series Inverter Different HorsePower	Can be Copied	Can not be Copied	New version parameters can NOT be copied to old version.
Different Series Inverter	Can not be Copied	Can not be Copied	

(5) LCD Operator (JN5-OP-A02)



Installation dimensions of LCD keypad display

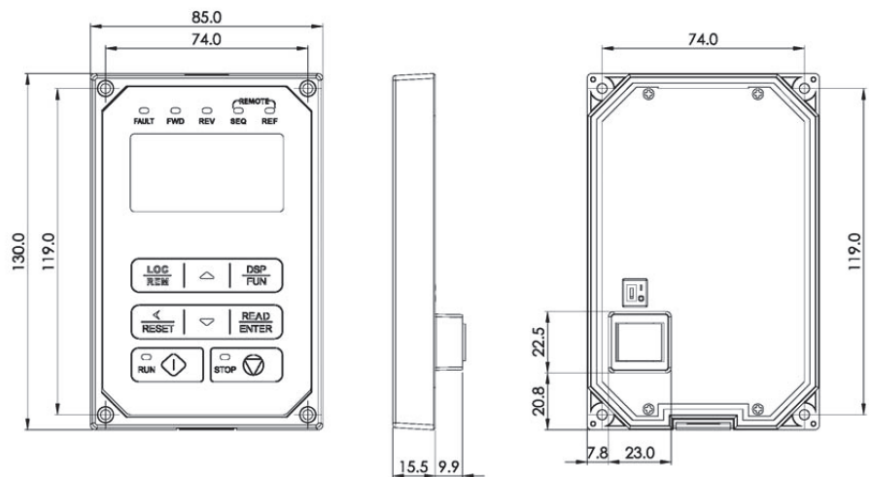

(6) Keypad holder (JN5-KEYBOX)

➤ Remote keypad can be installed more easily by this option.



➤ Installation dimensions of keypad holder

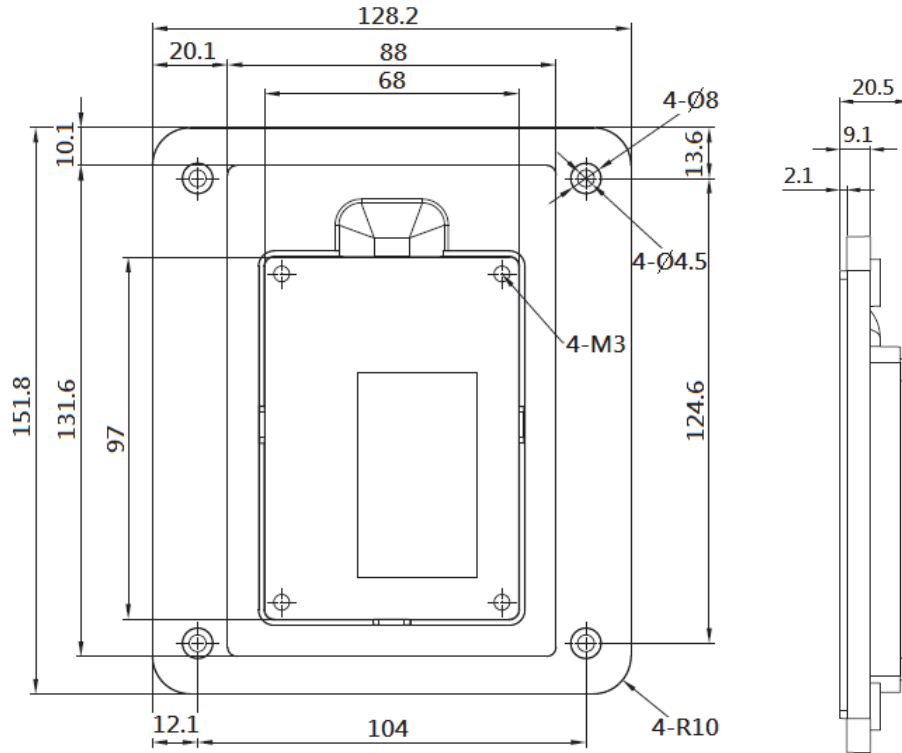

(7) Integrated communication card

(a) PROFIBUS communication card

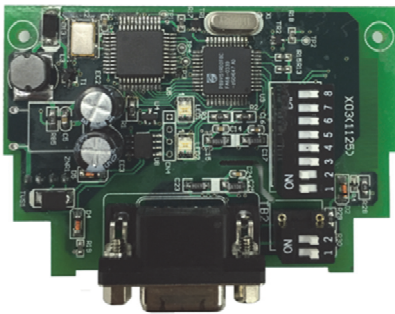

For wiring example and communication setup refer to JN5-CMI-PDP communication option manual.

(b) DEVICENET communication card

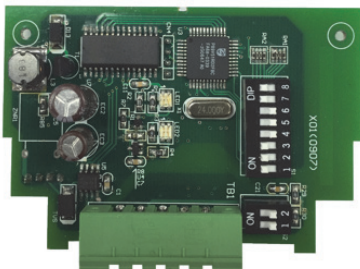

For wiring example and communication setup refer to JN5-CMI-DNET communication option manual.

(c) CANOPEN communication card

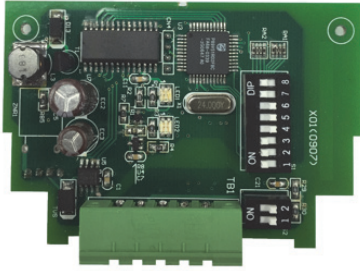

For wiring example and communication setup refer to JN5-CMI-CAN communication option manual.

(d) TCP-IP communication card



For wiring example and communication setup refer to JN5-CMI-TCP-IP communication option manual.

(8) Din-rail kit

- The options can fixed the drive on 35mm din-rail.
- Exterior :

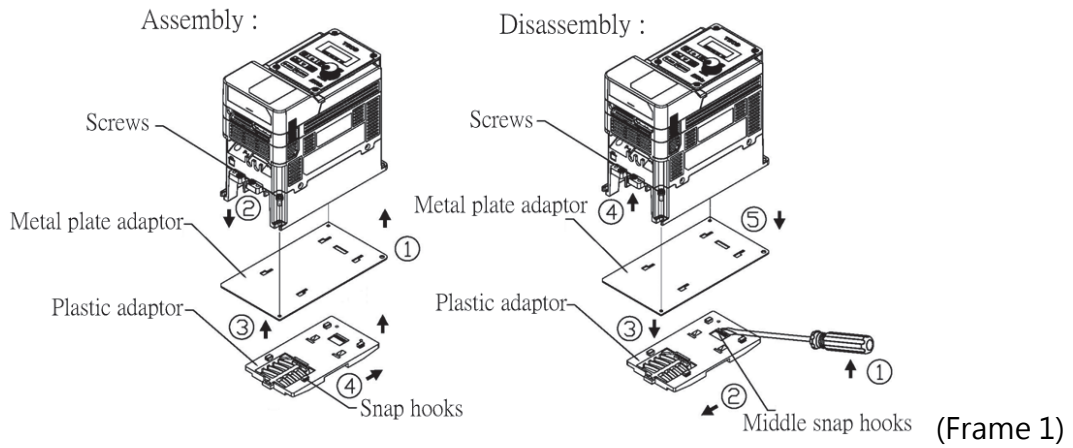

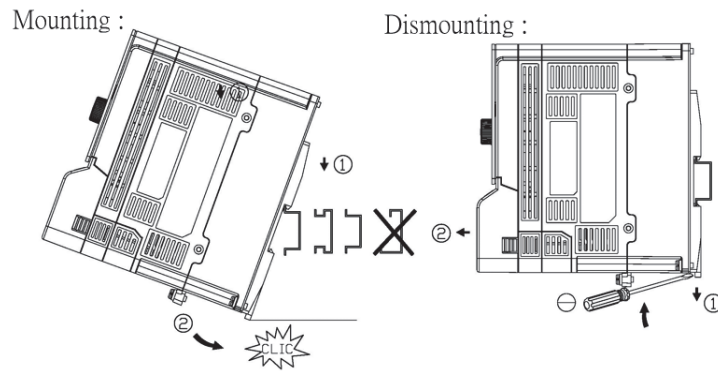
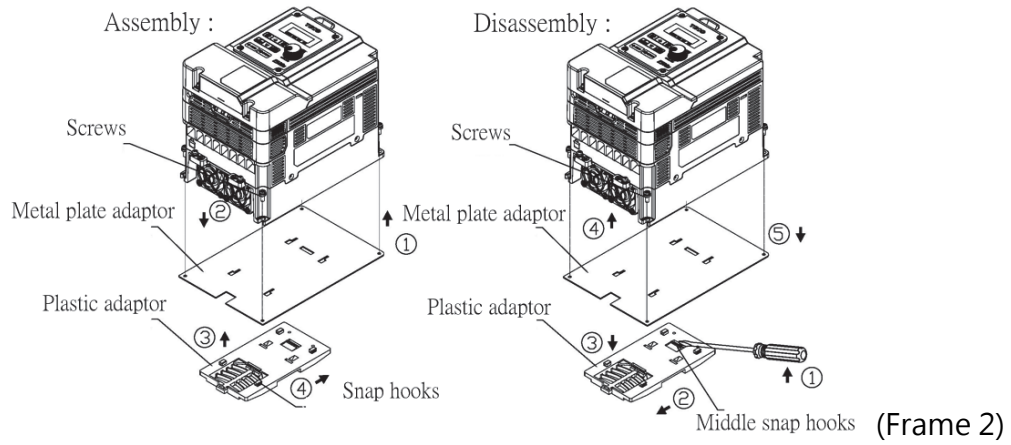

➤ JN5-DINF1/F2 including the following parts

Item	JN5-DINF1(Frame1)	JN5-DINF2(Frame2)
1	Metal plate adaptor(4KA76X1391T01)	Metal plate adaptor (4KA76X1392T01)
2	Chamfer head screw M4×12 (4KA77X011T11)	
3	Plastic adaptor(4KA82X442T01)	

Appendix 1 Instructions for UL

- Safety Precautions

DANGER

Electrical Shock Hazard

Do not connect or disconnect wiring while the power is on.

Failure to comply will result in death or serious injury.

WARNING

Electrical Shock Hazard

Do not operate equipment with covers removed.

Failure to comply could result in death or serious injury.

The diagrams in this section may show drives without covers or safety shields to show details. Be sure to reinstall covers or shields before operating the drives and run the drives according to the instructions described in this manual.

Always ground the motor-side grounding terminal.

Improper equipment grounding could result in death or serious injury by contacting the motor case.

Do not touch any terminals before the capacitors have fully discharged.

Failure to comply could result in death or serious injury.

Before wiring terminals, disconnect all power to the equipment. The internal capacitor remains charged even after the power supply is turned off. After shutting off the power, wait for at least the amount of time specified on the drive before touching any components.

Do not allow unqualified personnel to perform work on the drive.

Failure to comply could result in death or serious injury.

Installation, maintenance, inspection, and servicing must be performed only by authorized personnel familiar with installation, adjustment, and maintenance of AC drives.

Do not perform work on the drive while wearing loose clothing, jewelry, or lack of eye protection.

Failure to comply could result in death or serious injury.

Remove all metal objects such as watches and rings, secure loose clothing, and wear eye protection before beginning work on the drive.

Do not remove covers or touch circuit boards while the power is on.

Failure to comply could result in death or serious injury.

Fire Hazard

Tighten all terminal screws to the specified tightening torque.

Loose electrical connections could result in death or serious injury by fire due to overheating of electrical connections.

Do not use an improper voltage source.

Failure to comply could result in death or serious injury by fire.

Verify that the rated voltage of the drive matches the voltage of the incoming power supply before applying power.

Do not use improper combustible materials.

Failure to comply could result in death or serious injury by fire.

Attach the drive to metal or other noncombustible material.

NOTICE

Observe proper electrostatic discharge procedures (ESD) when handling the drive and circuit boards.

Failure to comply may result in ESD damage to the drive circuitry.

Never connect or disconnect the motor from the drive while the drive is outputting voltage.

Improper equipment sequencing could result in damage to the drive.

Do not use unshielded cable for control wiring.

Failure to comply may cause electrical interference resulting in poor system performance.

Use shielded twisted-pair wires and ground the shield to the ground terminal of the drive.

NOTICE

Do not modify the drive circuitry.

Failure to comply could result in damage to the drive and will void warranty.

Teco is not responsible for any modification of the product made by the user. This product must not be modified.

Check all the wiring to ensure that all connections are correct after installing the drive and connecting any other devices.

Failure to comply could result in damage to the drive.

- **UL Standards**

The UL/cUL mark applies to products in the United States and Canada and it means that UL has performed product testing and evaluation and determined that their stringent standards for product safety have been met. For a product to receive UL certification, all components inside that product must also receive UL certification.



● **UL Standards Compliance**

This drive is tested in accordance with UL standard UL508C and complies with UL requirements. To ensure continued compliance when using this drive in combination with other equipment, meet the following conditions:

● **Installation Area**

Do not install the drive to an area greater than pollution severity 2 (UL standard).

● **Main Circuit Terminal Wiring**

UL approval requires crimp terminals when wiring the drive's main circuit terminals. Use crimping tools as specified by the crimp terminal manufacturer. Teco recommends crimp terminals made by NICHIFU for the insulation cap. The table below matches drives models with crimp terminals and insulation caps. Orders can be placed with a Teco representative or directly with the Teco sales department.

Closed-Loop Crimp Terminal Size

Drive Model 11-201(series)	Wire Gauge mm2 (AWG)		Terminal Screws	Crimp Terminal Model No.	Tool Machine No.	Insulation Model No.
	R/L1, S/L2, T/L3	U/T1, V/T2, W,T3				
11-201-20-2P5-00	2 (14)		M3.5	R2-3.5	Nichifu NH 1/9	TIC 2
11-201-20-201-00	2 (14)		M3.5	R2-3.5	Nichifu NH 1/9	TIC 2
11-201-20-202-00	3.5 (12)		M4	R5.5-4	Nichifu NH 1/9	TIC 3.5
11-201-20-203-00	5.5 (10)		M4	R5.5-4	Nichifu NH 1/9	TIC 5.5
11-201-23-202-00	3.5 (12)		M4	R5.5-4	Nichifu NH 1/9	TIC 3.5
11-201-23-205-00	5.5 (10)		M4	R5.5-4	Nichifu NH 1/9	TIC 5.5
11-201-23-208-00	8 (8)		M4	R8-4	Nichifu NOP 60	TIC 8
11-201-23-210-00	8 (8)		M4	R8-4	Nichifu NOP 60	TIC 8
11-201-23-215-00	22 (4)		M6	R22-6	Nichifu NOP 60/150H	TIC 22
11-201-23-220-00	22 (4)		M6	R22-6	Nichifu NOP 60/150H	TIC 22
11-201-23-225-00	22 (4)		M6	R22-6	Nichifu NOP 60/150H	TIC 22
11-201-23-230-00	60 (1/0)		M8	R60-8	Nichifu NH 1/9	TIC 60
11-201-23-240-00	60 (1/0)		M8	R60-8	Nichifu NH 1/9	TIC 60
11-201-43-401-00	2 (14)		M3.5	R2-3.5	Nichifu NH 1/9	TIC 2
11-201-43-402-00	2 (14)		M3.5	R2-3.5	Nichifu NH 1/9	TIC 2
11-201-43-403-00	2 (14)		M4	R2-4	Nichifu NH 1/9	TIC 2
11-201-43-405-00	2 (14)		M4	R2-4	Nichifu NH 1/9	TIC 2
11-201-43-408-00	8 (8)		M4	R8-4	Nichifu NOP 60	TIC 8
11-201-43-410-00	8 (8)		M4	R8-4	Nichifu NOP 60	TIC 8
11-201-43-415-00	8 (8)		M4	R8-4	Nichifu NOP 60	TIC 8
11-201-43-420-00	8 (8)		M4	R8-4	Nichifu NOP 60	TIC 8
11-201-43-425-00	8 (8)		M4	R8-4	Nichifu NOP 60	TIC 8
11-201-43-430-00	14 (6)		M6	R14-6	Nichifu NOP 60/150H	TIC 14
11-201-43-440-00	38 (2)		M8	R38-8	Nichifu NOP 60/150H	TIC 38
11-201-43-450-00	38 (2)		M8	R38-8	Nichifu NOP 60/150H	TIC 38
11-201-43-460-00	38 (2)		M8	R38-8	Nichifu NOP 60/150H	TIC 38
11-201-43-475-00	38 (2)		M8	R38-8	Nichifu NOP 60/150H	TIC 38

Closed-Loop Crimp Terminal Size

Drive Model	Wire Gauge mm2 (AWG)		Terminal Screws	Crimp Terminal Model No.	Tool Machine No.	Insulation Model No.
	R/L1, S/L2, T/L3	U/T1, V/T2, W,T3				
11-301-21-2P5-30	2 (14)		M3.5	R2-3.5	Nichifu NH 1/9	TIC 2
11-301-21-201-30	2 (14)		M3.5	R2-3.5	Nichifu NH 1/9	TIC 2
11-301-21-202-30	3.5 (12)		M4	R5.5-4	Nichifu NH 1/9	TIC 3.5
11-301-21-203-30	5.5 (10)		M4	R5.5-4	Nichifu NH 1/9	TIC 5.5
11-301-43-401-30	2 (14)		M3.5	R2-3.5	Nichifu NH 1/9	TIC 2
11-301-43-402-30	2 (14)		M3.5	R2-3.5	Nichifu NH 1/9	TIC 2
11-301-43-403-30	2 (14)		M4	R2-4	Nichifu NH 1/9	TIC 2
11-301-43-405-30	2 (14)		M4	R2-4	Nichifu NH 1/9	TIC 2
11-301-43-408-30	8 (8)		M4	R8-4	Nichifu NOP 60	TIC 8
11-301-43-410-30	8 (8)		M4	R8-4	Nichifu NOP 60	TIC 8
11-301-43-415-30	8 (8)		M4	R8-4	Nichifu NOP 60	TIC 8
11-301-43-420-30	8 (8)		M4	R8-4	Nichifu NOP 60	TIC 8
11-301-43-425-30	8 (8)		M4	R8-4	Nichifu NOP 60	TIC 8
11-301-43-430-30	14 (6)		M6	R14-6	Nichifu NOP 60/150H	TIC 14
11-301-43-440-30	38 (2)		M8	R38-8	Nichifu NOP 60/150H	TIC 38
11-301-43-450-30	38 (2)		M8	R38-8	Nichifu NOP 60/150H	TIC 38
11-301-43-460-30	38 (2)		M8	R38-8	Nichifu NOP 60/150H	TIC 38
11-301-43-475-30	38 (2)		M8	R38-8	Nichifu NOP 60/150H	TIC 38

- **Motor Overtemperature Protection**

Motor overtemperature protection shall be provided in the end use application.

- **Field Wiring Terminals**

All input and output field wiring terminals not located within the motor circuit shall be marked to indicate the proper connections that are to be made to each terminal and indicate that copper conductors, rated 75°C are to be used.

- **Drive Short-Circuit Rating**

This drive has undergone the UL short-circuit test, which certifies that during a short circuit in the power supply the current flow will not rise above value. Please see electrical ratings for maximum voltage and table below for current. The MCCB and breaker protection and fuse ratings (refer to the preceding table) shall be equal to or greater than the short-circuit tolerance of the power supply being used.

Horse Power (Hp)	Current (A)	Voltage (V)
1 - 50	5000	240 / 480
51-200	10000	240 / 480

Recommended Input Fuse Selection

Drive Model 11-201/11-301	Fuse Type	
	Manufacturer: Bussmann / Ferraz Shawmut	
	Model	Fuse Ampere Rating
11-201-20-2P5-00	Bussmann 20CT	690V / 20A
11-201-20-201-00	Bussmann 20CT	690V / 20A
11-201-20-202-00	Bussmann 32FE	690V / 32A
11-201-20-203-00	Bussmann 50FE	690V / 50A
11-201-23-202-00	Bussmann 20CT	690V / 20A
11-201-23-205-00	Bussmann50FE	690V / 50A
11-201-23-208-00	Bussmann 63FE	690V / 63A
11-201-23-210-00	Ferraz Shawmut A50QS100-4	500V / 100A
11-201-23-215-00	Ferraz Shawmut A50QS150-4	500V / 150A
11-201-23-220-00	Ferraz Shawmut A50QS150-4	500V / 150A
11-201-23-225-00	Ferraz Shawmut A50QS200-4	500V / 200A
11-201-23-230-00	Ferraz Shawmut A50QS250-4	500V / 250A
11-201-23-240-00	Ferraz Shawmut A50QS300-4	500V / 300A
11-201-43-401-00	Bussmann 10CT	690V / 10A
11-201-43-402-00	Bussmann 16CT	690V / 16A
11-201-43-403-00	Bussmann 16CT	690V / 16A
11-201-43-405-00	Bussmann 25ET	690V / 25A
11-201-43-408-00	Bussmann 40FE	690V / 40A
11-201-43-410-00	Bussmann 50FE	690V / 50A
11-201-43-415-00	Bussmann 63FE	690V / 63A
11-201-43-420-00	Bussmann 80FE	690V / 80A
11-201-43-425-00	Ferraz Shawmut A50QS100-4	500V / 100A
11-201-43-430-00	Bussmann 120FEE	690V / 120A
11-201-43-440-00	Ferraz Shawmut A50QS150-4	500V / 150A
11-201-43-450-00	Ferraz Shawmut A50QS200-4	500V / 200A
11-201-43-460-00	Ferraz Shawmut A50QS250-4	500V / 250A
11-201-43-475-00	Ferraz Shawmut A50QS300-4	500V / 300A
11-301-21-2P5-30	Bussmann 16CT	690V / 16A
11-301-21-201-30	Bussmann 20CT	690V / 20A
11-301-21-202-30	Bussmann 32FE	690V / 32A
11-301-21-203-30	Bussmann 50FE	690V / 50A
11-301-43-401-30	Bussmann 10CT	690V / 10A
11-301-43-402-30	Bussmann 16CT	690V / 16A
11-301-43-403-30	Bussmann 16CT	690V / 16A
11-301-43-405-30	Bussmann 20CT	690V / 20A
11-301-43-408-30	Bussmann 32FE	690V / 32A
11-301-43-410-30	Bussmann 40FE	690V / 40A
11-301-43-415-30	Bussmann 63FE	690V / 63A
11-301-43-420-30	Bussmann 71FE	690V / 71A
11-301-43-425-30	Bussmann 100FEa	690V / 100A
11-301-43-430-30	Bussmann 100FEa	690V / 100A
11-301-43-440-30	Ferraz Shawmut A50QS125-4	500V / 125A
11-301-43-450-30	Ferraz Shawmut A50QS175-4	500V / 175A
11-301-43-460-30	Ferraz Shawmut A50QS200-4	500V / 200A
11-301-43-476-30	Ferraz Shawmut A50QS300-4	500V / 300A

Appendix 2 E510s Parameter Data

Customer					Model	
Application					Phone No.	
Address						
Parameter	Value	Parameter	Value	Parameter	Value	
Group 0		Group 1		Group 2		
0-00		1-00		2-00		
0-01		1-01		2-01		
0-02		1-02		2-02		
0-03		1-03		2-03		
0-04		1-04		2-04		
0-05		1-05		2-05		
0-06		1-06		2-06		
0-07		1-07		2-07		
0-08		1-08		2-08		
0-09		1-09		2-09		
0-10		1-10		2-10		
0-11		1-11		2-11		
0-12		1-12		2-12		
0-13		1-13		2-13		
0-14		1-14		2-14		
0-15		1-15		2-15		
0-16		1-16		2-16		
0-17		1-17		2-17		
0-18		1-18		2-18		
0-19		1-19		2-19		
0-20		1-20		2-20		
0-21		1-21		2-21		
0-22		1-22		2-22		
0-23		1-23		2-23		
0-24		1-24		2-24		
0-25		1-25		2-25		
0-26		1-26		2-26		
0-27				2-27		
0-28				2-28		
0-29				2-29		
0-30				2-30		
0-31				2-31		
0-32				2-32		
0-33				2-33		
0-34				2-34		
0-35						
0-36						

Parameter	Value	Parameter	Value	Parameter	Value
Group 3		Group 4		Group 5	
3 - 00		4 - 00		5 - 00	
3 - 01		4 - 01		5 - 01	
3 - 02		4 - 02		5 - 02	
3 - 03		4 - 03		5 - 03	
3 - 04		4 - 04		5 - 04	
3 - 05		4 - 05		5 - 05	
3 - 06		4 - 06		5 - 06	
3 - 07		4 - 07		5 - 07	
3 - 08		4 - 08		5 - 08	
3 - 09		4 - 09		5 - 09	
3 - 10		4 - 10		5 - 10	
3 - 11		4 - 11		5 - 11	
3 - 12		4 - 12		5 - 12	
3 - 13		4 - 13		5 - 13	
3 - 14		4 - 14		5 - 14	
3 - 15		4 - 15		5 - 15	
3 - 16		4 - 16		5 - 16	
3 - 17		4 - 17		5 - 17	
3 - 18		4 - 18		5 - 18	
3 - 19		4 - 19		5 - 19	
3 - 20		4 - 20		5 - 20	
3 - 21		4 - 21		5 - 21	
3 - 22		4 - 22		5 - 22	
3 - 23				5 - 23	
3 - 24				5 - 24	
3 - 25				5 - 25	
3 - 26				5 - 26	
3 - 27				5 - 27	
3 - 28				5 - 28	
3 - 29				5 - 29	
3 - 30				5 - 30	
3 - 31				5 - 31	
3 - 32				5 - 32	
3 - 33				5 - 33	
3 - 34				5 - 34	
3 - 35				5 - 35	
3 - 36				5 - 36	
3 - 37				5 - 37	
3 - 38				5 - 38	
3 - 39				5 - 39	
3 - 40				5 - 40	
3 - 41				5 - 41	
3 - 42				5 - 42	
3 - 43				5 - 43	
3 - 44				5 - 44	
3 - 45				5 - 45	
3 - 46				5 - 46	
3 - 47				5 - 47	
3 - 48				5 - 48	

Parameter	Value	Parameter	Value	Parameter	Value
Group 3		Group 6		Group 6	
3 - 49		6 - 00		6 - 41	
3 - 50		6 - 01		6 - 42	
3 - 51		6 - 02		6 - 43	
3 - 52		6 - 03		6 - 44	
3 - 53		6 - 04		6 - 45	
3 - 54		6 - 05		6 - 46	
		6 - 06		6 - 47	
		6 - 07			
		6 - 08			
		6 - 09			
		6 - 10			
		6 - 11			
		6 - 12			
		6 - 13			
		6 - 14			
		6 - 15			
		6 - 16			
		6 - 17			
		6 - 18			
		6 - 19			
		6 - 20			
		6 - 21			
		6 - 22			
		6 - 23			
		6 - 24			
		6 - 25			
		6 - 26			
		6 - 27			
		6 - 28			
		6 - 29			
		6 - 30			
		6 - 31			
		6 - 32			

Parameter	Value	Parameter	Value	Parameter	Value
Group 7		Group 8		Group 9	
7-00		8-00		9-00	
7-01		8-01		9-01	
7-02		8-02		9-02	
7-03		8-03		9-03	
7-04		8-04		9-04	
7-05		8-05		9-05	
7-06		8-06		9-06	
7-07		8-07		9-07	
7-08		8-08		9-08	
7-09		8-09		9-09	
7-10		8-10		9-10	
7-11		8-11			
7-12		8-12			
7-13		8-13			
7-14		8-14			
7-15		8-15			
7-16		8-16			
7-17		8-17			
7-18		8-18			
7-19		8-19			
7-20		8-20			
7-21		8-21			
7-22		8-22			
7-23		8-23			
7-24		8-24			
7-25		8-25			
7-26		8-26			
7-27		8-27			
7-28		8-28			
7-29		8-29			
7-30		8-30			
7-31		8-31			
7-32		8-32			
7-33		8-33			
7-34		8-34			
7-35		8-35			
7-36		8-36			
7-37		8-37			
7-38		8-38			
7-39		8-39			
7-40		8-40			
		8-41			
		8-42			
		8-43			
		8-44			
		8-46			
		8-47			
		8-48			

Parameter	Value	Parameter	Value	Parameter	Value
Group 7		Group 8		Group 9	
		8 - 49			
		8 - 50			
		8 - 51			
		8 - 52			
		8 - 53			
		8 - 54			
		8 - 55			
		8 - 56			
		8 - 57			
		8 - 58			
		8 - 59			
		8 - 60			

Parameter	Value	Parameter	Value	Parameter	Value
Group 10		Group 11		Group 11	
10 - 00		11 - 00		11 - 46	
10 - 01		11 - 01		11 - 47	
10 - 02		11 - 02		11 - 48	
10 - 03		11 - 03		11 - 49	
10 - 04		11 - 04		11 - 50	
10 - 05		11 - 05		11 - 51	
10 - 06		11 - 06		11 - 52	
10 - 07		11 - 07		11 - 53	
10 - 08		11 - 08		11 - 54	
10 - 09		11 - 09		11 - 55	
10 - 10		11 - 10		11 - 56	
10 - 11		11 - 11		11 - 57	
10 - 12		11 - 12		11 - 58	
10 - 13		11 - 13		11 - 59	
10 - 14		11 - 14		11 - 60	
10 - 15		11 - 15		11 - 61	
10 - 16		11 - 16		11 - 62	
10 - 17		11 - 17		11 - 63	
10 - 18		11 - 18		11 - 64	
10 - 19		11 - 19		11 - 65	
10 - 20		11 - 20		11 - 66	
10 - 21		11 - 21		11 - 67	
10 - 22		11 - 22		11 - 68	
10 - 23		11 - 23		11 - 69	
10 - 24		11 - 24		11 - 70	
10 - 25		11 - 25		11 - 71	
10 - 26		11 - 26		11 - 72	
10 - 27		11 - 27		11 - 73	
10 - 28		11 - 28			
10 - 29		11 - 29			
10 - 30		11 - 30			
10 - 31		11 - 31			
10 - 32		11 - 32			
10 - 33		11 - 33			
10 - 34		11 - 34			
10 - 35		11 - 35			
10 - 36		11 - 36			
10 - 37		11 - 37			
10 - 38		11 - 38			
10 - 39		11 - 39			
10 - 40		11 - 40			
10 - 47		11 - 41			
10 - 48		11 - 42			
10 - 49		11 - 43			
		11 - 44			
		11 - 45			

Parameter	Value	Parameter	Value	Parameter	Value
Group 12		Group 13		Group 14	
12 - 00		13 - 00		14 - 00	
12 - 01		13 - 01		14 - 01	
12 - 02		13 - 02		14 - 02	
12 - 03		13 - 03		14 - 03	
12 - 04		13 - 04		14 - 04	
12 - 05		13 - 05		14 - 05	
12 - 06		13 - 06		14 - 06	
12 - 07		13 - 07		14 - 07	
12 - 08		13 - 08		14 - 08	
12 - 09		13 - 09		14 - 09	
12 - 10		13 - 10		14 - 10	
12 - 11		13 - 21		14 - 11	
12 - 12		13 - 22		14 - 12	
12 - 13		13 - 23		14 - 13	
12 - 14		13 - 24		14 - 14	
12 - 15		13 - 25		14 - 15	
12 - 16		13 - 26		14 - 16	
12 - 17		13 - 27		14 - 17	
12 - 18		13 - 28		14 - 18	
12 - 19		13 - 29		14 - 19	
12 - 20		13 - 30		14 - 20	
12 - 21		13 - 31		14 - 21	
12 - 22		13 - 32		14 - 22	
12 - 23		13 - 33		14 - 23	
12 - 24		13 - 34		14 - 24	
12 - 25		13 - 35		14 - 25	
12 - 26		13 - 36		14 - 26	
12 - 27		13 - 37		14 - 27	
12 - 28		13 - 38		14 - 28	
12 - 29		13 - 39		14 - 29	
12 - 30		13 - 40		14 - 30	
12 - 31		13 - 41		14 - 31	
12 - 32		13 - 42		14 - 32	
12 - 33		13 - 43		14 - 33	
12 - 34		13 - 44		14 - 34	
12 - 35		13 - 45		14 - 35	
12 - 36		13 - 46		14 - 36	
12 - 37		13 - 47		14 - 37	
12 - 38		13 - 48		14 - 38	
12 - 39		13 - 49		14 - 39	
12 - 40		13 - 50		14 - 40	
12 - 41		13 - 51		14 - 41	
12 - 42				14 - 42	
12 - 43				14 - 43	
12 - 74				14 - 44	
12 - 75				14 - 45	
12 - 82				14 - 46	
12 - 83				14 - 47	

Parameter	Value	Parameter	Value	Parameter	Value
Group 15		Group 16		Group 17	
15 - 00		16 - 00		17 - 00	
15 - 01		16 - 01		17 - 01	
15 - 02		16 - 02		17 - 02	
15 - 03		16 - 03		17 - 03	
15 - 04		16 - 04		17 - 04	
15 - 05		16 - 05		17 - 05	
15 - 06		16 - 06		17 - 06	
15 - 07		16 - 07		17 - 07	
15 - 08		16 - 08		17 - 08	
15 - 09		16 - 09		17 - 09	
15 - 10				17 - 10	
15 - 11				17 - 11	
15 - 12				17 - 12	
15 - 13				17 - 13	
15 - 14				17 - 14	
15 - 15					
15 - 16					
15 - 17					
15 - 18					
15 - 19					
15 - 20					
15 - 21					
15 - 22					
15 - 23					
15 - 24					
15 - 25					
15 - 26					
15 - 27					
15 - 28					
15 - 29					
15 - 30					
15 - 31					
15 - 32					

Parameter	Value	Parameter	Value	Parameter	Value
Group 18		Group 20		Group 21	
18 - 00		20 - 00		21 - 00	
18 - 01		20 - 01		21 - 01	
18 - 02		20 - 02		21 - 02	
18 - 03		20 - 03		21 - 03	
18 - 04		20 - 04		21 - 04	
18 - 05		20 - 05		21 - 05	
18 - 06		20 - 06		21 - 06	
		20 - 07		21 - 07	
		20 - 08		21 - 08	
		20 - 09			
		20 - 10			
		20 - 11			
		20 - 12			
		20 - 13			
		20 - 14			
		20 - 15			
		20 - 16			
		20 - 17			
		20 - 18			
		20 - 19			
		20 - 20			
		20 - 21			
		20 - 22			
		20 - 23			
		20 - 24			
		20 - 25			
		20 - 26			
		20 - 27			
		20 - 28			
		20 - 29			
		20 - 30			
		20 - 31			
		20 - 32			
		20 - 33			
		20 - 34			
		20 - 35			

Parameter	Value	Parameter	Value	Parameter	Value
Group 22		Group 23		Group 23	
22 - 00		23 - 00		23 - 46	
22 - 01		23 - 01		23 - 47	
22 - 02		23 - 02		23 - 48	
22 - 03		23 - 03		23 - 49	
22 - 04		23 - 04		23 - 50	
22 - 05		23 - 05		23 - 51	
22 - 06		23 - 06		23 - 52	
22 - 07		23 - 07		23 - 53	
22 - 08		23 - 08		23 - 54	
22 - 09		23 - 09		23 - 55	
22 - 10		23 - 10		23 - 56	
22 - 11		23 - 11		23 - 57	
22 - 12		23 - 12		23 - 58	
22 - 13		23 - 13		23 - 59	
22 - 14		23 - 14		23 - 60	
22 - 15		23 - 15		23 - 61	
22 - 16		23 - 16		23 - 62	
22 - 17		23 - 17		23 - 63	
22 - 18		23 - 18		23 - 64	
22 - 19		23 - 19		23 - 65	
22 - 20		23 - 22		23 - 66	
22 - 21		23 - 23		23 - 67	
22 - 22		23 - 24		23 - 68	
22 - 23		23 - 25		23 - 69	
22 - 24		23 - 26		23 - 70	
22 - 25		23 - 27		23 - 71	
22 - 26		23 - 28		23 - 72	
22 - 27		23 - 29		23 - 73	
22 - 28		23 - 30		23 - 74	
22 - 29		23 - 31		23 - 75	
22 - 34		23 - 34		23 - 76	
		23 - 35		23 - 77	
		23 - 37		23 - 78	
		23 - 38			
		23 - 39			
		23 - 40			
		23 - 41			
		23 - 42			
		23 - 43			
		23 - 44			
		23 - 45			

Appendix 3 Modbus Protocol Description

Communication Connection and Data Frame

The inverter can communicate with a PC or PLC via RS485 or RS232 using the Modbus RTU or Modbus ASCII protocol. The maximum frame length is 80 bytes.

Network Connection

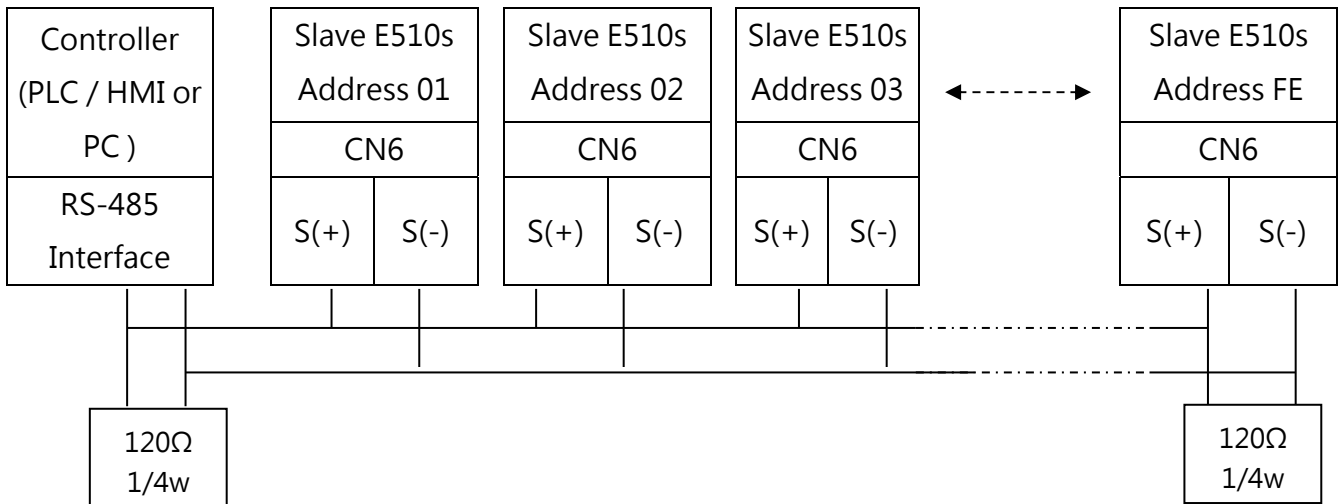

**** Terminate the communications line with a (120 ohm, 1/4 watt) resistor at both ends.****

CN6 Pin out :

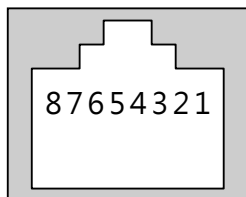

PIN	Signal	PIN	Signal
1	RS485 Data+ signal	5	Tx signal
2	RS485 Data- signal	6	RS485 Data- signal
3	RS485 Data+ signal	7	VCC of isolated 5V power supply
4	Reserved	8	GND of isolated 5V power supply

For RS-485 communication use pin 1 or pin 3 for S (+) and pin 2 or pin 6 for S (-).

**Data Format Frame
FOR ASCII MODE**

STX(3AH)	Start Bit = 3AH
Address Hi	Communication Address(Station): 2-digit ASCII Code
Address Lo	
Function Hi	Function Code (command): 2-digit ASCII Code
Function Lo	
Command Start Address	Command Start byte: 4-digit ASCII Code
Command Start Address	
Command Start Address	
Command Start Address	
Data length	The length of the command: 4-digit ASCII Code
Data length	
Data length	
Data length	
LRC Check Hi	LRC Check Code: 2-digit ASCII Code
LRC Check Lo	
END Hi	End Byte: END Hi=CR(0DH), END Li = LF(0AH)
END Lo	

➤ **FOR RTU MODE**

Master (PLC etc.) sends request to follower (inverter), and the follower sends a response to the master (PC, PLC). The data received is illustrated here.

**The inverter response time is 10ms.

SLAVE Address
Function Code
DATA
CRC CHECK
Signal Interval

➤ **Node Address**

00H : Broadcast to all the drivers

01H : to the No. 01 inverter

0FH : to the No.15 inverter

10H : to the No.16 inverter and so on..., max to No.31 (1FH)

➤ **Function Code**

03H : Read the register contents

06H : Write a WORD to register

08H : Loop test

10H : Write several data to register (complex number register write)

➤ **Checksum Calculation**

LRC

ex. ADDRESS	01H
FUNCTION	03H
COMMAND	01H
	00H
+ DATA LENGTH	0AH

	0FH-----2's complement
Checksum =	F1H
CS(H) =	46H (ASCII)
CS(L) =	31H (ASCII)

CRC

CRC Check :

CRC code covers the content from node address to DATA. Please calculate it according to the following methods.

- (1) Load a 16-bit register with FFFF hex (all1's). Call this CRC register.
- (2) Exclusive OR the first 8-bit byte of the message, the low-order byte of the 16-bit CRC register, putting the result in the CRC register.
- (3) Shift the CRC register one bit to the right (toward the LSB), Zero-filling the MSB, Extract and examines the LSB.
- (4) (If the LSB was 0): Repeat Steps (3) (another shift)
(If the LSB was 1): Exclusive OR the CRC register with the polynomial value A001 hex (1010 0000 0000 0001), putting the result in CRC register.
- (5) Repeat Steps (3) and (4) until 8 shifts been performed. When this is done, a complete 8-bit byte will be processed.
- (6) Repeat Steps (2) through (5) for next 8-bit byte of the message, Continue doing this until all bytes have been processed. The final content in the CRC register is the CRC value. When sending the CRC value, the Low-order byte should be sent firstly, then the High-order byte. For example, CRC value: 1241 Hex, the high-order byte should be set to 41hex and low-order byte 12hex.

➤ **CRC calculate program**

```

UWORD ch_sum ( UBYTE long , UBYTE *rxdbuff ) {
    BYTE i = 0;
    UWORD wkg = 0xFFFF;
    while ( long-- ) {
        wkg ^= rxdbuff++;
        for ( i = 0 ; i < 8 ; i++ ) {
            if ( wkg & 0x0001 ) {
                wkg = ( wkg >> 1 ) ^ 0xa001;
            }
            else {
                wkg = wkg >> 1;
            }
        }
    }
    return( wkg );
}

```

➤ **Error Code**

ASCII Mode

STX	'.'
Address	'0'
	'1'
Function	'8'
	'6'
Exception code	'5'
	'1'
LRC Check	'2'
	'8'
END	'CR'
	'LF'

RTU Mode

SLAVE Address	02H	
Function	83H	
Exception code	52H	
CRC-16	High	C0H
	Low	CDH

During a communication error the drive will response with an Exception Code and send a message back to the main system consisting of a Function Code that is "ANDED (and 80h)" with 80 Hex.

Error Code	Content
01	Function code error
02	Register number error
03	DATA setting error
04	Register number is over 32

➤ Register and Data Format

Command Data (Read/Write)

Register No.	Bit	Content
2500H	Reserved	
2501H	0	Operation Command 1 : Run 0 : Stop
	1	Reverse Command 1 : Reverse 0 : Forward
	2	External Fault 1 : Fault
	3	Fault Reset 1 : Reset
	4	Reserved
	5	Reserved
	6	Multi-function Comm S1 1 : "ON"
	7	Multi-function Comm S2 1 : "ON"
	8	Multi-function Comm S3 1 : "ON"
	9	Multi-function Comm S4 1 : "ON"
	A	Multi-function Comm S5 1 : "ON"
	B	Multi-function Comm S6 1 : "ON"
	C	Reserved
	D	Reserved
	E	Inverter mode 1 : "ON"
F	Reserved	
2502H	*Frequency Command (Unit: 0.01Hz)	
2503H	Reserved	
2504H	Reserved	
2505H	AO1 (0.00V ~ 10.00V)	
2506H	Reserved	
2507H	Reserved	
2508H	Reserved	
2509H	Reserved	
250AH	Reserved	
250BH	Reserved	
250CH	Reserved	
250DH	Reserved	
250EH	Reserved	
250FH	Static Auto Tune 1 : " ON"	
2510H	G12-00 H-WORD	
2511H	G12-00 L-WORD	

Note : Write in zero for Not used BIT, do not write in data for the reserved register.

➤ Monitor Data (Read-only)

Register No.	Bit	Content		
2520H	0	Operation	1 : Run 0 : Stop	
	1	Direction	1 : Reverse 0 : Forward	
	2	Inverter ready	1 : ready 0 : unready	
	3	Fault	1 : Abnormal	
	4	Warning	1 : "ON"	
	5	Zero Speed	1 : "ON"	
	6	Is440V	1 : "ON"	
	7	Frequency Agree	1 : "ON"	
	8	Set Frequency Agree	1 : "ON"	
	9	Frequency Detection 1	1 : "ON"	
	A	Frequency Detection 2	1 : "ON"	
	B	Under Voltage	1 : "ON"	
	C	Baseblock	1 : "ON"	
	D	Freq Ref. not from Comm.	1 : "ON"	
	E	Seq. not from Comm.	1 : "ON"	
	F	Reserved	1 : "ON"	
2521H	0	Reserved	31	Reserved
	1	UV	32	Reserved
	2	OC	33	Reserved
	3	OV	34	Reserved
	4	OH1	35	Reserved
	5	OL1	36	Reserved
	6	OL2	37	Reserved
	7	OT	38	CF07
	8	Reserved	39	Reserved
	9	SC	40	Reserved
	10	Ground OC	41	Reserved
	11	Reserved	42	LPBFT(Low Pressure Fault)
	12	Input Phase Loss	43	OPBFT(High Pressure Fault)
	13	Output Phase Loss	44	FBLSS(PID Feedback Signal Loss)
	14	Reserved	45	Reserved
	15	Reserved	46	OH4
	16	Reserved	47	Reserved
	17	EF1(External Terminal S1 fault)	48	Reserved
	18	EF2(External Terminal S2 fault)	49	MtrSw (DI Motor Switch Fault)
	19	EF3(External Terminal S3 fault)	50	OC_A
	20	EF4(External Terminal S4 fault)	51	OC_D
	21	EF5(External Terminal S5 fault)	52	OC_C
	22	EF6(External Terminal S6 fault)	53	Reserved
	23	Reserved	54	CF_08

Register No.	Bit	Content							
	24	Reserved			55	STO2			
	25	PID Feedback Error			56	STO3			
	26	Keypad Removed			57	PO			
	27	Reserved			58	PF			
	28	CE			59	TOL(External Overload)			
	29	STO1			60	Reserved			
	30	Reserved			61	Reserved			
2522H	DI State	0 Terminal S1							
		1 Terminal S2							
		2 Terminal S3							
		3 Terminal S4							
		4 Terminal S5							
		5 Terminal S6							
		6 Reserved							
		7 Reserved							
		8 Reserved							
		9 Reserved							
		A Reserved							
		B Reserved							
		C Reserved							
		D Reserved							
		E Reserved							
F Reserved									
2523H	Frequency command (0.01Hz)								
2524H	Output frequency (0.01Hz)								
2525H	Reserved								
2526H	DC voltage command (0.1V)								
2527H	Output current (0.1A)								
2528H	Warning Description	0	No alarm	20	EF4	40	EF9	60	Reserved
		1	OV	21	EF5	41	Reserved	61	RETRY
		2	UV	22	EF6	42	Reserved	62	Reserved
		3	OL2	23	Reserved	43	RDP	63	Reserved
		4	Reserved	24	Reserved	44	Reserved	64	Reserved
		5	OH3	25	Reserved	45	OL1	65	OH1
		6	OT	26	Reserved	46	Reserved	66	FIRE
		7	Reserved	27	Reserved	47	Reserved	67	ES
		8	Reserved	28	Reserved	48	COPUP	68	STP1
		9	Reserved	29	Reserved	49	BB1	69	BDERR
		10	Reserved	30	RDE	50	BB2	70	EPERR

Register No.	Bit	Content							
	11	Reserved	31	WRE	51	BB3	71	Reserved	
	12	Reserved	32	FB	52	BB4	72	Reserved	
	13	CE	33	VRYE	53	BB5	73	STP0	
	14	Reserved	34	SE01	54	BB6	74	Reserved	
	15	Reserved	35	SE02	55	Reserved	75	STP2	
	16	EF0	36	SE03	56	Reserved	76	RUNER	
	17	EF1	37	Reserved	57	LOPb	77	LOC	
	18	EF2	38	SE05	58	HIPb	79	C0000	
	19	EF3	39	HPERR	59	Reserved	80	INIT	
							81	FBLSS	
2529H		Digital Output State							
252AH		AO1 (0.00V ~ 10.00V)							
252BH		Reserved							
252CH		AI 1 Input (0.1%)							
252DH		AI 2 Input (0.1%)							
252EH		Keypad analog input(1000 / 5V)							
252FH		Reserved							
2531H		AO1 (0.00V ~ 10.00V)							
2533H		Heat Sink Temperature (°C)							
2534H		Output Power (kw)							
2536H		OL1 Value							
2537H		OL2 Value							
253BH		IPL Value							
253CH		OPL Value							

Note :

Do not write in data for the reserved register.

➤ **Read Holding Register [03H]**

Read consecutive holding registers. The address of the first holding register is specified in the protocol

Example: Read frequency command from the inverter with node address 1.

ASCII Mode

Command Message

3AH	STX
30H	Node Address
31H	
30H	Function
33H	
30H	Starting Register
43H	
31H	
30H	
30H	Number of Registers
30H	
30H	
31H	
44H	LRC CHECK
46H	
0DH	END
0AH	

Response Message (Normal)

3AH	STX
30H	Node Address
31H	
30H	Function
33H	
30H	Data Length
32H	
31H	Initial Save Register
37H	
37H	
30H	
37H	LRC CHECK
33H	
0DH	END
0AH	

Response Message (Error)

3AH	STX
30H	Node Address
31H	
38H	Function
33H	
30H	Exception code
34H	
34H	LRC CHECK
30H	
0DH	END
0AH	

+

RTU Mode

Command Message

Node Address		01 H
Function		03H
Starting Register	High	0CH
	Low	10H
Number of Registers	High	00H
	Low	01H
CRC-16	High	86H
	Low	9FH

Response Message (Normal)

Node Address		01H
Function		03H
DATA Length		02H
Initial Save Register	High	17H
	Low	70H
CRC-16	High	B6H
	Low	50H

Response Message (Error)

Node Address		01H
Function		83H
Exception Code		04H
CRC-16	High	40H
	Low	F3H

➤ **Loop back test [08H]**

Check the communication between the master and the follower (inverter). The data used can be arbitrary.

ASCII Mode

Command Message

3AH	STX
30H	Node
31H	Address
30H	Function
38H	
30H	Test Code
30H	
30H	
30H	
41H	DATA
35H	
33H	
37H	
31H	LRC CHECK
42H	
0DH	END
0AH	

Response Message (Normal)

3AH	STX
30H	Node
31H	Address
30H	Function
38H	
30H	Test Code
30H	
30H	
30H	
41H	DATA
35H	
33H	
37H	
31H	LRC CHECK
42H	
0DH	END
0AH	

Response Message (Error)

3AH	STX
30H	Node
31H	Address
38H	Function
38H	
30H	Exception code
33H	
30H	LRC CHECK
36H	
0DH	END
0AH	

RTU Mode

Command Message

Node Address		01 H
Function		08H
Test Code	High	00H
	Low	00H
Number of Registers	High	A5H
	Low	37H
CRC-16	High	DAH
	Low	8DH

Response Message (Normal)

Node Address		01H
Function		08H
Test Code	High	00H
	Low	00H
Number of Registers	High	A5H
	Low	37H
CRC-16	High	DAH
	Low	8DH

Response Message (Error)

Node Address		01H
Function		88H
Exception code		03H
CRC-16	High	06H
	Low	01H

➤ **Write Single Holding Register [06H]**

Write single holding register. The register address of the holding register is specified in the message.

Example: Write a 60.00Hz frequency command to node address 1.

ASCII Mode

Command Message

3AH	STX
30H	Node Address
31H	
30H	Function
36H	
32H	Starting Register
35H	
30H	
32H	
31H	DATA
37H	
37H	
30H	
34H	LRC CHECK
42H	
0DH	END
0AH	

Response Message (Normal)

3AH	STX
30H	Node Address
31H	
30H	Function
36H	
32H	Starting Register
35H	
30H	
32H	
31H	DATA
37H	
37H	
30H	
34H	LRC CHECK
42H	
0DH	END
0AH	

Response Message (Error)

3AH	STX
30H	Node Address
31H	
38H	Function
36H	
30H	Exception code
33H	
30H	LRC CHECK
32H	
0DH	END
0AH	

RTU Mode

Command Message

Node Address		01 H
Function		06H
Start No	High	25H
	Low	02H
Number of Registers	High	17H
	Low	70H
CRC-16	High	2DH
	Low	12H

Response Message (Normal)

Node Address		01H
Function		06H
Start No	High	Exception code
	Low	
Number of Registers	High	17H
	Low	70H
CRC-16	High	2DH
	Low	12H

Response Message (Error)

Node Address		01H
Function		86H
Exception code		03H
CRC-16	High	02H
	Low	61H

➤ **Write Multiple Holding Register [10H]**

Write multiple holding registers. The address of the first holding register is specified in the message.

Example: Write a 60.00Hz frequency command to node address 1 and enable FWD run command.

ASCII Mode

Command Message

3AH	STX
30H	Node
31H	Address
31H	Function
30H	
32H	Starting Register
35H	
30H	
31H	
30H	Number of Registers
30H	
30H	
32H	
30H	Number of DATA
34H	
30H	DATA 1
30H	
30H	
31H	
31H	DATA 2
37H	
37H	
30H	
33H	LRC CHECK
42H	
0DH	END
0AH	

Response Message (Normal)

3AH	STX
30H	Node
31H	Address
31H	Function
30H	
32H	Starting Register
35H	
30H	
31H	
30H	Number of Registers
30H	
30H	
32H	
43H	LRC CHECK
37H	
0DH	END
0AH	

Response Message (Error)

3AH	STX
30H	Node
31H	Address
39H	Function
30H	
30H	Exception code
33H	
30H	LRC CHECK
43H	
0DH	END
0AH	

* Number of bytes is register amount x 2

RTU Mode

Command Message

Node Address		01 H
Function		10H
Starting Register	High	25H
	Low	01H
Number of Registers	High	00H
	Low	02H
Number of DATA		04H
DATA 1	High	00H
	Low	01H
DATA 2	High	17H
	Low	70H
CRC-16	High	60H
	Low	27H

Response Message (Normal)

Node Address		01H
Function		10H
Starting Register	High	Exception code
	Low	01H
Number of Registers	High	00H
	Low	02H
CRC-16	High	High
	Low	04H

Response Message (Error)

Node Address		01H
Function		90H
Exception code		03H
CRC-16	High	0CH
	Low	01H

* Data amount is register amount x 2

Parameter Data

Function	Register No	Function	Register No	Function	Register No
Group 0		Group 1		Group 2	
0-00	0000H	1-00	0100H	2-00	0200H
0-01	0001H	1-01	0101H	2-01	0201H
0-02	0002H	1-02	0102H	2-02	0202H
0-03	0003H	1-03	0103H	2-03	0203H
0-04	0004H	1-04	0104H	2-04	0204H
0-05	0005H	1-05	0105H	2-05	0205H
0-06	0006H	1-06	0106H	2-06	0206H
0-07	0007H	1-07	0107H	2-07	0207H
0-08	0008H	1-08	0108H	2-08	0208H
0-09	0009H	1-09	0109H	2-09	0209H
0-10	000AH	1-10	010AH	2-10	020AH
0-11	000BH	1-11	010BH	2-11	020BH
0-12	000CH	1-12	010CH	2-12	020CH
0-13	000DH	1-13	010DH	2-13	020DH
0-14	000EH	1-14	010EH	2-14	020EH
0-15	000FH	1-15	010FH	2-15	020FH
0-16	0010H	1-16	0110H	2-16	0210H
0-17	0011H	1-17	0111H	2-17	0211H
0-18	0012H	1-18	0112H	2-18	0212H
0-19	0013H	1-19	0113H	2-19	0213H
0-20	0014H	1-20	0114H	2-20	0214H
0-21	0015H	1-21	0115H	2-21	0215H
0-22	0016H	1-22	0116H	2-22	0216H
0-23	0017H	1-23	0117H	2-23	0217H
0-24	0018H	1-24	0118H	2-24	0218H
0-25	0019H	1-25	0119H	2-25	0219H
0-26	001AH	1-26	011AH	2-26	021AH
0-27	001BH			2-27	021BH
0-28	001CH			2-28	021CH
0-29	001DH			2-29	021DH
0-30	001EH			2-30	021EH
0-31	001FH			2-31	021FH
0-32	0020H			2-32	0220H
0-33	0021H			2-33	0221H
0-34	0022H			2-34	0222H
0-35	0023H				
0-36	0024H				

Function	Register No	Function	Register No	Function	Register No
Group 3		Group 4		Group 5	
3 – 00	0300H	4 – 00	0400H	5 – 00	0500H
3 – 01	0301H	4 – 01	0401H	5 – 01	0501H
3 – 02	0302H	4 – 02	0402H	5 – 02	0502H
3 – 03	0303H	4 – 03	0403H	5 – 03	0503H
3 – 04	0304H	4 – 04	0404H	5 – 04	0504H
3 – 05	0305H	4 – 05	0405H	5 – 05	0505H
3 – 06	0306H	4 – 06	0406H	5 – 06	0506H
3 – 07	0307H	4 – 07	0407H	5 – 07	0507H
3 – 08	0308H	4 – 08	0408H	5 – 08	0508H
3 – 09	0309H	4 – 09	0409H	5 – 09	0509H
3 – 10	030AH	4 – 10	040AH	5 – 10	050AH
3 – 11	030BH	4 – 11	040BH	5 – 11	050BH
3 – 12	030CH	4 – 12	040CH	5 – 12	050CH
3 – 13	030DH	4 – 13	040DH	5 – 13	050DH
3 – 14	030EH	4 – 14	040EH	5 – 14	050EH
3 – 15	030FH	4 – 15	040FH	5 – 15	050FH
3 – 16	0310H	4 – 16	0410H	5 – 16	0510H
3 – 17	0311H	4 – 17	0411H	5 – 17	0511H
3 – 18	0312H	4 – 18	0412H	5 – 18	0512H
3 – 19	0313H	4 – 19	0413H	5 – 19	0513H
3 – 20	0314H	4 – 20	0414H	5 – 20	0514H
3 – 21	0315H	4 – 21	0415H	5 – 21	0515H
3 – 22	0316H	4 – 22	0416H	5 – 22	0516H
3 – 23	0317H			5 – 23	0517H
3 – 24	0318H			5 – 24	0518H
3 – 25	0319H			5 – 25	0519H
3 – 26	031AH			5 – 26	051AH
3 – 27	031BH			5 – 27	051BH
3 – 28	031CH			5 – 28	051CH
3 – 29	031DH			5 – 29	051DH
3 – 30	031EH			5 – 30	051EH
3 – 31	031FH			5 – 31	051FH
3 – 32	0320H			5 – 32	0520H
3 – 33	0321H			5 – 33	0521H
3 – 34	0322H			5 – 34	0522H
				5 – 35	0523H
				5 – 36	0524H
				5 – 37	0525H
				5 – 38	0526H
				5 – 39	0527H
				5 – 40	0528H
				5 – 41	0529H
				5 – 42	052AH
				5 – 43	052BH
				5 – 44	052CH
				5 – 45	052DH
				5 – 46	052EH
				5 – 47	052FH

Function	Register No	Function	Register No	Function	Register No
Group 5		Group 6		Group 6	
5 – 48	0530H	6 – 00	0600H	6 – 41	0629H
		6 – 01	0601H	6 – 42	062AH
		6 – 02	0602H	6 – 43	062BH
		6 – 03	0603H	6 – 44	062CH
		6 – 04	0604H	6 – 45	062DH
		6 – 05	0605H	6 – 46	062EH
		6 – 06	0606H	6 – 47	062FH
		6 – 07	0607H		
		6 – 08	0608H		
		6 – 09	0609H		
		6 – 10	060AH		
		6 – 11	060BH		
		6 – 12	060CH		
		6 – 13	060DH		
		6 – 14	060EH		
		6 – 15	060FH		
		6 – 16	0610H		
		6 – 17	0611H		
		6 – 18	0612H		
		6 – 19	0613H		
		6 – 20	0614H		
		6 – 21	0615H		
		6 – 22	0616H		
		6 – 23	0617H		
		6 – 24	0618H		
		6 – 25	0619H		
		6 – 26	061AH		
		6 – 27	061BH		
		6 – 28	061CH		
		6 – 29	061DH		
		6 – 30	061EH		
		6 – 31	061FH		
		6 – 32	0620H		

Function	Register No	Function	Register No	Function	Register No
Group 7		Group 8		Group 9	
7-00	0700H	8-00	0800H	9-00	0900H
7-01	0701H	8-01	0801H	9-01	0901H
7-02	0702H	8-02	0802H	9-02	0902H
7-03	0703H	8-03	0803H	9-03	0903H
7-04	0704H	8-04	0804H	9-04	0904H
7-05	0705H	8-05	0805H	9-05	0905H
7-06	0706H	8-06	0806H	9-06	0906H
7-07	0707H	8-07	0807H	9-07	0907H
7-08	0708H	8-08	0808H	9-08	0908H
7-09	0709H	8-09	0809H	9-09	0909H
7-10	070AH	8-10	080AH	9-10	090AH
7-11	070BH	8-11	080BH		
7-12	070CH	8-12	080CH		
7-13	070DH	8-13	080DH		
7-14	070EH	8-14	080EH		
7-15	070FH	8-15	080FH		
7-16	0710H	8-16	0810H		
7-17	0711H	8-17	0811H		
7-18	0712H	8-18	0812H		
7-19	0713H	8-19	0813H		
7-20	0714H	8-20	0814H		
7-21	0715H	8-21	0815H		
7-22	0716H	8-22	0816H		
7-23	0717H	8-23	0817H		
7-24	0718H	8-24	0818H		
7-25	0719H	8-25	0819H		
7-26	071AH	8-26	081AH		
7-27	071BH	8-27	081BH		
7-28	071CH	8-28	081CH		
7-29	071DH	8-29	081DH		
7-30	071EH	8-30	081EH		
7-31	071FH	8-31	081FH		
7-32	0720H	8-32	0820H		
7-33	0721H	8-33	0821H		
7-34	0722H	8-34	0822H		
7-35	0723H	8-35	0823H		
7-36	0724H	8-36	0824H		
7-37	0725H	8-37	0825H		
7-38	0726H	8-38	0826H		
7-39	0727H	8-39	0827H		
7-40	0728H	8-40	0828H		
		8-41	0829H		

Function	Register No	Function	Register No	Function	Register No
Group 7		Group 8		Group 9	
		8 – 42	082AH		
		8 – 43	082BH		
		8 – 44	082CH		
		8 – 45			
		8 – 46			
		8 – 47			
		8 – 48	0830H		
		8 – 49	0831H		
		8 – 50	0832H		
		8 – 51	0833H		
		8 – 52	0834H		
		8 – 53	0835H		
		8 – 54	0836H		
		8 – 55	0837H		
		8 – 56	0838H		
		8 – 57	0839H		
		8 – 58	083AH		
		8 – 59	083BH		
		8 – 60	083CH		

Function	Register No	Function	Register No	Function	Register No
Group 10		Group 11		Group 11	
10 – 00	0A00H	11 – 00	0B00H	11 – 46	0B2EH
10 – 01	0A01H	11 – 01	0B01H	11 – 47	0B2FH
10 – 02	0A02H	11 – 02	0B02H	11 – 48	0B30H
10 – 03	0A03H	11 – 03	0B03H	11 – 49	0B31H
10 – 04	0A04H	11 – 04	0B04H	11 – 50	0B32H
10 – 05	0A05H	11 – 05	0B05H	11 – 51	0B33H
10 – 06	0A06H	11 – 06	0B06H	11 – 52	0B34H
10 – 07	0A07H	11 – 07	0B07H	11 – 53	0B35H
10 – 08	0A08H	11 – 08	0B08H	11 – 54	0B36H
10 – 09	0A09H	11 – 09	0B09H	11 – 55	0B37H
10 – 10	0A0AH	11 – 10	0B0AH	11 – 56	0B38H
10 – 11	0A0BH	11 – 11	0B0BH	11 – 57	0B39H
10 – 12	0A0CH	11 – 12	0B0CH	11 – 58	0B3AH
10 – 13	0A0DH	11 – 13	0B0DH	11 – 59	0B3BH
10 – 14	0A0EH	11 – 14	0B0EH	11 – 60	0B3CH
10 – 15	0A0FH	11 – 15	0D0FH	11 – 61	0B3DH
10 – 16	0A10H	11 – 16	0B10H	11 – 62	0B3EH
10 – 17	0A11H	11 – 17	0B11H	11 – 63	0B3FH
10 – 18	0A12H	11 – 18	0B12H	11 – 64	0B40H

Function	Register No	Function	Register No	Function	Register No
Group 10		Group 11		Group 11	
10 – 19	0A13H	11 – 19	0B13H	11 – 65	0B41H
10 – 20	0A14H	11 – 20	0B14H	11 – 66	0B42H
10 – 21	0A15H	11 – 21	0B15H	11 – 67	0B43H
10 – 22	0A16H	11 – 22	0B16H	11 – 68	0B44H
10 – 23	0A17H	11 – 23	0B17H	11 – 69	0B45H
10 – 24	0A18H	11 – 24	0B18H	11 – 70	0B46H
10 – 25	0A19H	11 – 25	0B19H	11 – 71	0B47H
10 – 26	0A1AH	11 – 26	0B1AH	11 – 72	0B48H
10 – 27	0A1BH	11 – 27	0B1BH	11 – 73	0B49H
10 – 28	0A1CH	11 – 28	0B1CH		
10 – 29	0A1DH	11 – 29	0B1DH		
10 – 30	0A1EH	11 – 30	0B1EH		
10 – 31	0A1FH	11 – 31	0B1FH		
10 – 32	0A20H	11 – 32	0B20H		
10 – 33	0A21H	11 – 33	0B21H		
10 – 34	0A22H	11 – 34	0B22H		
10 – 35	0A23H	11 – 35	0B23H		
10 – 36	0A24H	11 – 36	0B24H		
10 – 37	0A25H	11 – 37	0B25H		
10 – 38	0A26H	11 – 38	0B26H		
10 – 39	0A27H	11 – 39	0B27H		
10 – 40	0A28H	11 – 40	0B28H		
10 – 41		11 – 41	0B29H		
10 – 42		11 – 42	0B2AH		
10 – 43		11 – 43	0B2BH		
10 – 44		11 – 44	0B2CH		
10 – 45		11 – 45	0B2DH		
10 – 46	-				
10 – 47	0A2FH				
10 – 48	0A30H				
10 – 49	0A31H				

Function	Register No	Function	Register No	Function	Register No
Group 12		Group 13		Group 14	
12 – 00	High WORD: 2510H Low WORD: 2511H	13 – 00	0D00H	14 – 00	0E00H
12 – 01	0C01H	13 – 01	0D01H	14 – 01	0E01H
12 – 02	0C02H	13 – 02	0D02H	14 – 02	0E02H
12 – 03	0C03H	13 – 03	0D03H	14 – 03	0E03H

Function	Register No	Function	Register No	Function	Register No
Group 12		Group 13		Group 14	
12 – 04	0C04H	13 – 04	0D04H	14 – 04	0E04H
12 – 05	0C05H	13 – 05	0D05H	14 – 05	0E05H
12 – 06	0C06H	13 – 06	0D06H	14 – 06	0E06H
12 – 07	0C07H	13 – 07	0D07H	14 – 07	0E07H
12 – 08	0C08H	13 – 08	0D08H	14 – 08	0E08H
12 – 09	0C09H	13 – 09	0D09H	14 – 09	0E09H
12 – 10	0C0AH	13 – 10	0D0AH	14 – 10	0E0AH
12 – 11	0C0BH	13 – 21	0D15H	14 – 11	0E0BH
12 – 12	0C0CH	13 – 22	0D16H	14 – 12	0E0CH
12 – 13	0C0DH	13 – 23	0D17H	14 – 13	0E0DH
12 – 14	0C0EH	13 – 24	0D18H	14 – 14	0E0EH
12 – 15	0C0FH	13 – 25	0D19H	14 – 15	0E0FH
12 – 16	0C10H	13 – 26	0D1AH	14 – 16	0E10H
12 – 17	0C11H	13 – 27	0D1BH	14 – 17	0E11H
12 – 18	0C12H	13 – 28	0D1CH	14 – 18	0E12H
12 – 19	0C13H	13 – 29	0D1DH	14 – 19	0E13H
12 – 20	0C14H	13 – 30	0D1EH	14 – 20	0E14H
12 – 21	0C15H	13 – 31	0D1FH	14 – 21	0E15H
12 – 22	0C16H	13 – 32	0D20H	14 – 22	0E16H
12 – 23	0C17H	13 – 33	0D21H	14 – 23	0E17H
12 – 24	0C18H	13 – 34	0D22H	14 – 24	0E18H
12 – 25	0C19H	13 – 35	0D23H	14 – 25	0E19H
12 – 26	0C1AH	13 – 36	0D24H	14 – 26	0E1AH
12 – 27	0C1BH	13 – 37	0D25H	14 – 27	0E1BH
12 – 28	0C1CH	13 – 38	0D26H	14 – 28	0E1CH
12 – 29	0C1DH	13 – 39	0D27H	14 – 29	0E1DH
12 – 30	0C1EH	13 – 40	0D28H	14 – 30	0E1EH
12 – 31	0C1FH	13 – 41	0D29H	14 – 31	0E1FH
12 – 32	0C20H	13 – 42	0D2AH	14 – 32	0E20H
12 – 33	0C21H	13 – 43	0D2BH	14 – 33	0E21H
12 – 34	0C22H	13 – 44	0D2CH	14 – 34	0E22H
12 – 35	0C23H	13 – 45	0D2DH	14 – 35	0E23H
12 – 36	0C24H	13 – 46	0D2EH	14 – 36	0E24H
12 – 37	0C25H	13 – 47	0D2FH	14 – 37	0E25H
12 – 38	0C26H	13 – 48	0D30H	14 – 38	0E26H
12 – 39	0C27H	13 – 49	0D31H	14 – 39	0E27H
12 – 40	0C28H	13 – 50	0D32H	14 – 40	0E28H
12 – 41	0C29H	13 – 51	0D33H	14 – 41	0E29H
12 – 42	0C2AH			14 – 42	0E2AH
12 – 43	0C2BH			14 – 43	0E2BH
12 – 74	0C28H			14 – 44	0E2CH
12 – 75	0C4BH			14 – 45	0E2DH

Function	Register No	Function	Register No	Function	Register No
Group 12		Group 13		Group 14	
12 - 82	0C52H			14 - 46	0E2EH
12 - 83	0C53H			14 - 47	0E2FH

Function	Register No	Function	Register No	Function	Register No
Group 15		Group 16		Group 17	
15 - 00	0F00H	16 - 00	1000H	17 - 00	1100H
15 - 01	0F01H	16 - 01	1001H	17 - 01	1101H
15 - 02	0F02H	16 - 02	1002H	17 - 02	1102H
15 - 03	0F03H	16 - 03	1003H	17 - 03	1103H
15 - 04	0F04H	16 - 04	1004H	17 - 04	1104H
15 - 05	0F05H	16 - 05	1005H	17 - 05	1105H
15 - 06	0F06H	16 - 06	1006H	17 - 06	1106H
15 - 07	0F07H	16 - 07	1007H	17 - 07	1107H
15 - 08	0F08H	16 - 08	1008H	17 - 08	1108H
15 - 09	0F09H	16 - 09	1009H	17 - 09	1109H
15 - 10	0F0AH			17 - 10	110AH
15 - 11	0F0BH			17 - 11	110BH
15 - 12	0F0CH			17 - 12	110CH
15 - 13	0F0DH			17 - 13	110DH
15 - 14	0F0EH			17 - 14	110EH
15 - 15	0F0FH				
15 - 16	0F10H				
15 - 17	0F11H				
15 - 18	0F12H				
15 - 19	0F13H				
15 - 20	0F14H				
15 - 21	0F15H				
15 - 22	0F16H				
15 - 23	0F17H				
15 - 24	0F18H				
15 - 25	0F19H				
15 - 26	0F1AH				
15 - 27	0F1BH				
15 - 28	0F1CH				
15 - 29	0F1DH				
15 - 30	0F1EH				
15 - 31	0F1FH				
15 - 32	0F20H				

Function	Register No	Function	Register No	Function	Register No
Group 18		Group 20		Group 21	
18 – 00	1200H	20 – 00	1400H	21 – 00	1500H
18 – 01	1201H	20 – 01	1401H	21 – 01	1501H
18 – 02	1202H	20 – 02	1402H	21 – 02	1502H
18 – 03	1203H	20 – 03	1403H	21 – 03	1503H
18 – 04	1204H	20 – 04	1404H	21 – 04	1504H
18 – 05	1205H	20 – 05	1405H	21 – 05	1505H
18 – 06	1206H	20 – 06	1406H	21 – 06	1506H
		20 – 07	1407H	21 – 07	1507H
		20 – 08	1408H	21 – 08	1508H
		20 – 09	1409H		
		20 – 10	140AH		
		20 – 11	140BH		
		20 – 12	140CH		
		20 – 13	140DH		
		20 – 14	140EH		
		20 – 15	140FH		
		20 – 16	1410H		
		20 – 17	1411H		
		20 – 18	1412H		
		20 – 19	1413H		
		20 – 20	1414H		
		20 – 21	1415H		
		20 – 22	1416H		
		20 – 23	1417H		
		20 – 24	1418H		
		20 – 25	1419H		
		20 – 26	141AH		
		20 – 27	141BH		
		20 – 28	141CH		
		20 – 29	141DH		
		20 – 30	141EH		
		20 – 31	141FH		
		20 – 32	1420H		
		20 – 33	1421H		
		20 – 34	1422H		
		20 – 35	1423H		

Function	Register No	Function	Register No		
Group 22		Group 23			
22 – 00	1600H	23 – 00	1700H		
22 – 01	1601H	23 – 01	1701H		
22 – 02	1602H	23 – 02	1702H		
22 – 03	1603H	23 – 03	1703H		
22 – 04	1604H	23 – 04	1704H		
22 – 05	1605H	23 – 05	1705H		
22 – 06	1606H	23 – 06	1706H		
22 – 07	1607H	23 – 07	1707H		
22 – 08	1608H	23 – 08	1708H		
22 – 09	1609H	23 – 09	1709H		
22 – 10	160AH	23 – 10	170AH		
22 – 11	160BH	23 – 11	170BH		
22 – 12	160CH	23 – 12	170CH		
22 – 13	160DH	23 – 13	170DH		
22 – 14	160EH	23 – 14	170EH		
22 – 15	160FH	23 – 15	170FH		
22 – 16	1610H	23 – 16	1710H		
22 – 17	1611H	23 – 17	1711H		
22 – 18	1612H	23 – 18	1712H		
22 – 19	1613H	23 – 19	1713H		
22 – 20	1614H	23 – 20	1714H		
22 – 21	1615H	23 – 21	-		
22 – 22	1616H	23 – 22	-		
22 – 23	1617H	23 – 23	1717H		
22 – 24	1618H	23 – 24	1718H		
22 – 25	1619H	23 – 25	1719H		
		23 – 26	171AH		
		23 – 27	171BH		
		23 – 28	171CH		
		23 – 29	171DH		
		23 – 30	171EH		
		23 – 31	171FH		
		23 – 32	1720H		
		23 – 33	1721H		
		23 – 34	1722H		
		23 – 35	1723H		
		23 – 36	-		
		23 – 37	1735H		
		23 – 38	1736H		
		23 – 39	1737H		
		23 – 71	1747H		
		23 – 72	1748H		
		23 – 73	1749H		

BACnet Specifications Description

Inverter E510s model is built-in standard BACnet MS/TP communication protocol structure to meet the demand of automatic communication equipment. Control or monitor E510s via BACnet to be allowable to read and modify specific parameter. E510s includes the following supports of standard objects :

- Inverter Objects
- Analog Output
- Analog Value
- Analog Input
- Digital Output
- Digital Value
- Digital Input

E510s is supporting the property information of object classification. User can collect related properties of objects required via the dedicated communication software of BACnet to give control or monitor command for each object :

Proerty	Inverter (DEV)	Analog Input (AI)	Analog Output (AO)	Analog Value (AV)	Digital Input (BI)	Digital Output (BO)	Digital Value (BV)
Object_Identifier	V	V	V	V	V	V	V
Object_Name	V	V	V	V	V	V	V
Object_Type	V	V	V	V	V	V	V
System_Status	V						
Vendor_Name	V						
Vendor_Identifier	V						
Model_Name	V						
Firmware_Revision	V						
Applocation_Software_Supported	V						
Protocol_Version	V						
Protocol_Revision	V						
Protocol_Services_Supported	V						
Protocol_Object_Type_Supported	V						
Object_List	V						
Max_APDU_Length_Accepted							
Segmentation_Supported							
APDU_Timeout							
Number_Of_APDU_Retries							
Max_Masters	V						
Max_Info_Frames	V						
Device_Address_Binding							
Location	V						
Presnent_Value		V	V	V	V	V	V
Status_Flags							
Event_State							
Relibility							
Out_Of_Service							
Units		V	V	V			
Priority_Array							
Relinquish_Default							

Property	Inverter (DEV)	Analog Input (AI)	Analog Output (AO)	Analog Value (AV)	Digital Input (BI)	Digital Output (BO)	Digital Value (BV)
Polarity							
Inactive_Text							
Active_Text							

BACnet Object Properties :

This section provides the predetermined configuration of the inverter. User can achieve the optimized situation at any necessary modification. Refer to Table 2 for the property information of inverter objects and user can learn the inverter messages from the inverter objects. Refer to Table 3 ~ 8 for the related object information that inverter supports. User can control/ read each object with the application requirements.

Table 2 Inverter property list

Property	Inverter
Object_Identifier	DEV
Object_Name	VFD
Object_Type	8
System_Status	0
Vendor_Name	VFD
Vendor_Identifier	461
Model_Name	VFD
Firmware_Revision	0.14
Application_Software_Supported	0.14
Protocol_Version	1
Protocol_Revision	5
Protocol_Services_Supported	{ readProperty , writeProperty , who is }
Protocol_Object_Type_Supported	{ Analog_Input , Analog_Output, Analog_Value Binary_Input, Binary_Output, Binary_Value, Device}
Max_Masters	127
Max_Info_Frames	1

Table 3 Analog input property list (Read)

No.	Object Name	Description	Unit	Classification	Range
AI0	TM2 AIN	AVI input	Volt	R	0-10
AI1	TM2 AIN2	ACI input	Volt	R	0-10
AI2	Error code	Recent fault message	No Units	R	0-45
AI3	Freq cmd	Frequency command	Hz	R	0-60
AI4	Frequency	Output frequency	Hz	R	0-60
AI5	Current	Output current	Amps	R	
AI6	Control Mode	Control mode	No Units	R	0-2
AI7	Motor R-Volt	Motor rated voltage	Volt	R	

No.	Object Name	Description	Unit	Classification	Range
AI8	Motor R-HP	Motor rated power	horsepower	R	
AI9	Motor R-RPM	Motor rated rotation speed	No Units	R	
AI10	Motor R-Hz	Motor rated frequency	Hz	R	
AI11	CarrierFreq	Carrier frequency	KiloHertz	R	4-16
AI12	Comm Station	INV communication station	No Units	R	1-254
AI13	BaudRate	Baudrate setting	No Units	R	0-3
AI14	BacnetSel	Communication mode selection	No Units	R	0-1
AI15	DevInstance	Inverter number	No Units	R	1-254

Table 4 Analog output property list (Read/Write)

No.	Object Name	Description	Unit	Classification	Range
AO0	Set frequency	Frequency command	Hz	R/W	0-599
AO1	TB2 AO1	Analog output voltage 1	Volt	R	0-10
AO2	-	-	-	-	-
AO3	Motor R-Amp	Motor rated current	Amps	R/W	0-65535
AO4	PwrL Sel	Momentary stop and restart selection	No Units	R	0-1
AO5	RestartSel	Number of Fault Auto-Restart Attempts	No Units	R	0-10
AO6	RestartDelay	Fault Auto-Restart Time	seconds	R	0-7200
AO7	FreqCommand1	Speed frequency setting-stage 0	Hz	R/W	0-599
AO8	FreqCommand2	Speed frequency setting-stage 1	Hz	R/W	0-599
AO9	FreqCommand3	Speed frequency setting-stage 2	Hz	R/W	0-599
AO10	FreqCommand4	Speed frequency setting-stage 3	Hz	R/W	0-599
AO11	FreqCommand5	Speed frequency setting-stage 4	Hz	R/W	0-599
AO12	FreqCommand6	Speed frequency setting-stage 5	Hz	R/W	0-599
AO13	FreqCommand7	Speed frequency setting-stage 6	Hz	R/W	0-599
AO14	FreqCommand8	Speed frequency setting-stage 7	Hz	R/W	0-599
AO15	FreqCommand9	Speed frequency setting-stage 8	Hz	R/W	0-599
AO16	FreqCommand10	Speed frequency setting-stage 9	Hz	R/W	0-599
AO17	FreqCommand11	Speed frequency setting-stage 10	Hz	R/W	0-599
AO18	FreqCommand12	Speed frequency setting-stage 11	Hz	R/W	0-599
AO19	FreqCommand13	Speed frequency setting-stage 12	Hz	R/W	0-599
AO20	FreqCommand14	Speed frequency setting-stage 13	Hz	R/W	0-599
AO21	FreqCommand15	Speed frequency setting-stage 14	Hz	R/W	0-599
AO22	FreqCommand16	Speed frequency setting-stage 15	Hz	R/W	0-599
AO23	RunMode	Main run command source	No Units	R/W	0-2
AO24	ReverseOper	Direction locked command	No Units	R/W	0-1
AO25	StoppingSel	Stop modes selection	No Units	R/W	0-1
AO26	FrequenceComm	Main frequency command source	No Units	R/W	0-5
AO27	FreqUpperLim	Upper limit frequency	Hz	R/W	0-599
AO28	FreqLowerLim	Lower limit frequency	Hz	R/W	0-598.99
AO29	Acc Time1	Acceleration time 1	seconds	R/W	0-6000.0
AO30	Dec Time1	Deceleration time 1	seconds	R/W	0-6000.0

Table 5 Analog value property list (Read/Write)

No.	Object Name	Description	Unit	Classification	Range
AV0	PID-P Gain	Proportional gain (P)	No Units	R/W	0-10
AV1	PID-I Time	Integral time (I)	No Units	R/W	0-100
AV2	PID-D Time	Differential time (D)	No Units	R/W	0-10

Table 6 Digital input property list (Read)

No.	Object Name	Description	Unit	Classification	Range
BI0	Run/Stop	Operation status	Stop / Run	R	0-1
BI1	Direction	Operation direction	FWD/REV	R	0-1
BI2	status	Inverter status	OK/Fault	R	0-1
BI3	Abnormal	Error occurs	Close/Open	R	0-1
BI4	DI_1 status	S1 status	Close/Open	R	0-1
BI5	DI_2 status	S2 status	Close/Open	R	0-1
BI6	DI_3 status	S3 status	Close/Open	R	0-1
BI7	DI_4 status	S4 status	Close/Open	R	0-1
BI8	DI_5 status	S5 status	Close/Open	R	0-1
BI9	DI_6 status	Operation status	Close/Open	R	0-1

Table 7 Digital output property list (Read/Write)

No.	Object Name	Description	Unit	Classification	Range
BO0	RY1 status	Relay output 1 status	Close/Open	R	0-1
BO1	RY2 status	Relay output 1 status	Close/Open	R	0-1
BO2	-	-	-	-	-

Table 8 Digital value property list (Read/Write)

No.	Object Name	Description	Unit	Classification	Range
BV0	RUN/STOP	RUN/STOP	Stop / Run	R/W	0-1
BV1	FWD/REV	FWD/REV	FWD/REV	R/W	0-1

Appendix 4 JN5-CM-USB Instruction

1. Model & Specification

1.1 Instruction

JN5-CM-USB has the function of converting USB communication format to RS485 to achieve the inverter communication control being similar with PC or other control equipment with USB port.

1.2 Exterior(Unit : mm)

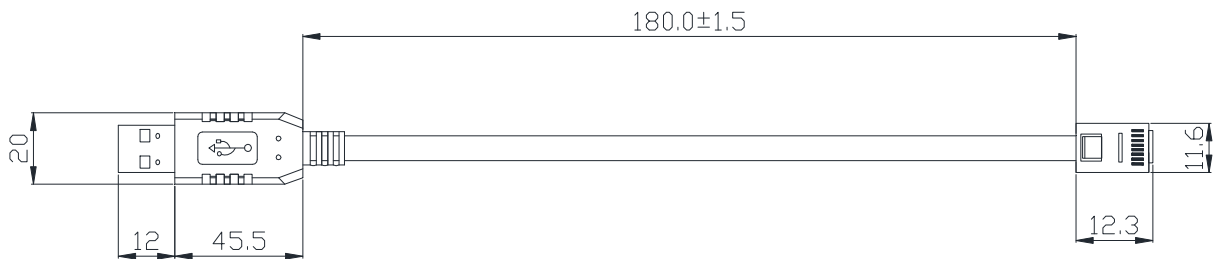

1.3 Connecting

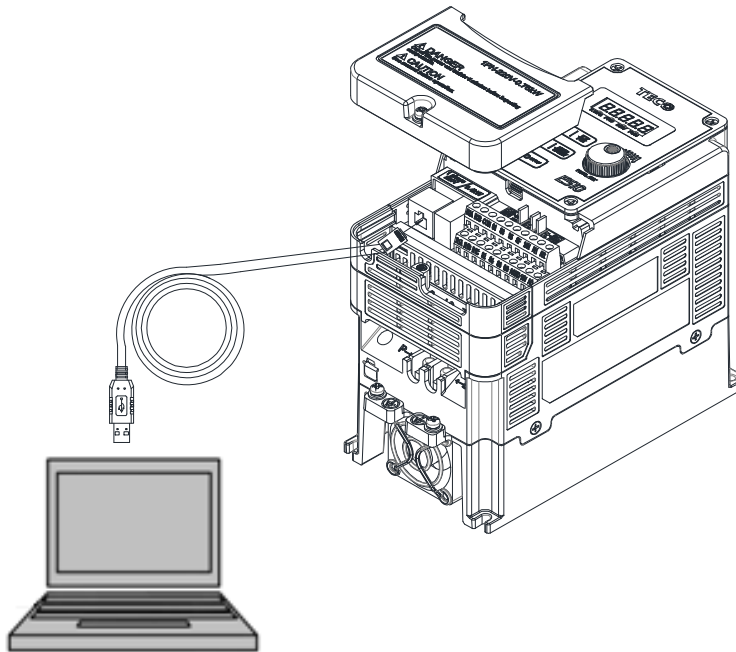

2. USB interface cable pin definition

2.1 RS232/USB interface

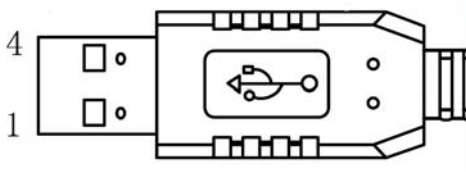

USB interface, connects with PC or other USB interface devices

2.2 RS485/RJ45 interface

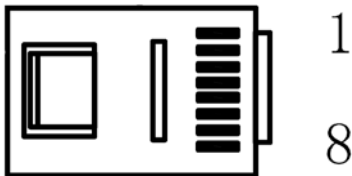

2.3 RS485/RJ45 pin definition

Pin No.,	1	2	3	4	5	6	7	8
Define	A	B	NC	NC	NC	NC	VCC	GND

Note :

A/B phase signal (pin1&pin2) is differential mode data signal of RS485.

VCC&GND is the +5Vdc power supply provided by inverter internal power source.

3. Notice

- Please turn off the power before you connect the cable..
- When inverter is powered off during communication. PC software will show “communication error”.
- If any error occurs during communication, check the wiring connection and restart the pc software.

Appendix 5 : Accessories

Accessories	Model	Description	Note
Cables	JN5-CB-01M	IP20 Digital operator extension cable	1 meter
	JN5-CB-02M		2 meters
	JN5-CB-03M		3 meters
	JN5-CB-05M		5 meters
	JN5-CM-USB	RJ45 to USB connecting cable	1.8 meters
NEMA1 Kits	JN5-NK-SE01	Mechanical device consisting of anti-dust cover on the upper part and wiring box on the bottom to meet NEMA1. (Frame 5/6 has been designed to NEMA1 protection level, does not need to add the accessories)	Frame 1
	JN5-NK-SE02		Frame 2
	JN5-NK-SE03		Frame 3
	JN5-NK-SE04		Frame 4
Copy Module	JN5-CU	<ul style="list-style-type: none"> ① Duplicating parameters setting of same series inverter from one inverter to another inverter. ② As a remote keypad to be used 	Remote keypad function only can be used in L510s series
LCD Digital Operator	JN5-OP-A02	IP20 LCD type for remote control (Built-in parameter copy function)	Option only
Keypad Display Holder	JN5-KEYBOX	Keypad display can be fixed on the panel.	Dual direction installation
Communication Card	JN5-CMI-PDP	For connection of Profibus-DP communication protocol	Profibus DP
	JN5-CMI-TCP/IP	For connection of TCP-IP communication protocol	TCP-IP
	JN5-CMI-DNET	For connection of DeviceNet communication protocol	DeviceNet
	JN5-CMI-CAN	For connection of CAN open communication protocol	CANopen

INVERTER 11-301 series

Safety stop function instruction manual

CONTENTS

- 1. General description 1**
- 2. Installation and wiring 2**
- 3. Example of safety system configuration..... 5**
- 4. Test and checking failure 7**
- 5. Safety parameters of 11-301..... 8**

Compliance with the EU Machinery Directive – Functional Safety

WARNING

Safe Torque off function may not be an appropriate method for stopping your machine. Activating this function will result in no output voltage to the Motor hence motor will coast down to stop under the influence of the load inertia.

WARNING

Any misuse of safety function could lead to personal injury or death, property damage, or economic loss. To ensure that the system complies fully with requirement of safety, make a system-level risk assessment. TECO Electric Co. cannot assume responsibility for any system to comply with safety directive.

CAUTION

The information of this manual is merely a guide for proper installation. TECO Electric Co. cannot assume responsibility for the compliance or the noncompliance to any code, national, local or otherwise for the proper installation of this equipment. A hazard of personal injury and/or equipment damage exists if codes are ignored during installation.

WARNING

To avoid an electric shock hazard, verify that the voltage on the bus capacitors has discharged before performing any work on the drive. Measure the DC bus voltage at the P(+) and N(-) terminals or test points (refer to your drive' s *User Manual* for locations and discharging time). The voltage must be zero.

WARNING

To avoid an electric shock hazard, disconnect/isolate power to the drive and verify to ensure that the voltage is zero before performing any work on the motor (refer to your drive' s *User Manual* for discharging time).

CAUTION

In order to maintain the pollution degree 2 the devices shall be mounted in a cabinet of IP 54 type .or pollution controlled environment.

CAUTION

Ensure that the external safety relay unit and the E510s drive are mounted close to each other all interconnection wiring is as short as possible and protected against open and short circuit faults. Refer EN/ISO13849-1.

CAUTION

To avoid systematic faults, a test even for faulty demands of the safety function has to be performed in order to check the correct function of the monitor signal. This test shall be carried out at system installation, any software changes, parameterization changes, and/or at least once per year. Refer to "Chapter 5 Troubleshooting and Fault Diagnostics" .

1. Introduction

This document describes the main design specification of the E510s Safe Torque Off (STO) and the requirements for its installation and integration within safety related applications.

The correct Installation and integration of the E510s STO is the responsibility of the Installer and it is expected that the installer follows the safety guide and is a trained technician and experienced in the design of safety systems.

E510s STO (Safe Torque Off) circuit and function is certified by Tuv to:

- Safety Integrated category SIL2 according to EN/IEC 62061, IEC 61508, EN61800-5-2
- Performance level. Category 3/ Pl(d). according to EN/ISO 13849-1 Stop category 0.
According to EN60204-1

2. Safety-Related Requirements

2.1 Directives

IEC/EN 61800- 5-2 : 2007	Adjustable Speed Electrical Power Drive Systems. Part 5-2: Safety Requirements – Functional
EN ISO 13849-1: 2008	Safety of Machinery – Safety-related parts of control systems. Part 1: General Principles for Design
IEC 61508- 1~7	Functional Safety of Electrical/Electronic/Programmable Electronic Safety-related systems
IEC 62061: 2005	Safety of Machinery – Functional safety of safety-related electrical, electronic and programmable electronic control systems
EN 60204-1	Safety of machinery - Electrical equipment of machines. General requirements.

2.2 Installation Environment

E510s safety stop function should only be used under the following condition and environment.

Item		Condition
Temperature range	Operation	-10°C~50°C inside distributor (without dust cover) -10°C~40°C inside distributor (with dust cover)
	Storage	-20°C to +60°C
Ambient humidity		95%RH maximum (non-condensing)
Shock		1G. (9.8m/s ²) for 20Hz and below. 0.6G (5.88m/s ²) from 20Hz to 50Hz (Compliance with IEC 60068-
Altitude		maximum 1000m above sea level
Atmosphere		Indoors (without corrosive gas, flammable gas, oil mist, dust and
Over voltage category		II or less
Pollution degree		II or less
Mounting		wall mounting / vertical orientation

Table 1.

3. Product Information

3.1 Product models & range

- 230V single Phase. IP 20 0.40 ~ 2.2KW. (3hp)
- 400V three phase. IP20 0.75 ~ 55 KW. (75hp)

Model	Horsepower	Power Specification	Voltage (Volt)	Current (A)
Frame1	0.5/1	200V~240V	600	20
	1/2	380V~480V		
Frame2	2/3/5	200V~240V	600	45
	3/5	380V~480V		
Frame 3/4	7.5/10/15/20	200V~240V	600	100
	7.5/10/15/20/25	380V~480V	600	165
Frame 5	25	200V ~ 240V	600	100
	30	380V ~ 480V	600	75
Frame 6	30/40	200V ~ 240V	600	175
	40/50/60/75	380V ~ 480V	600	

Table 2

3.2 Product Identification

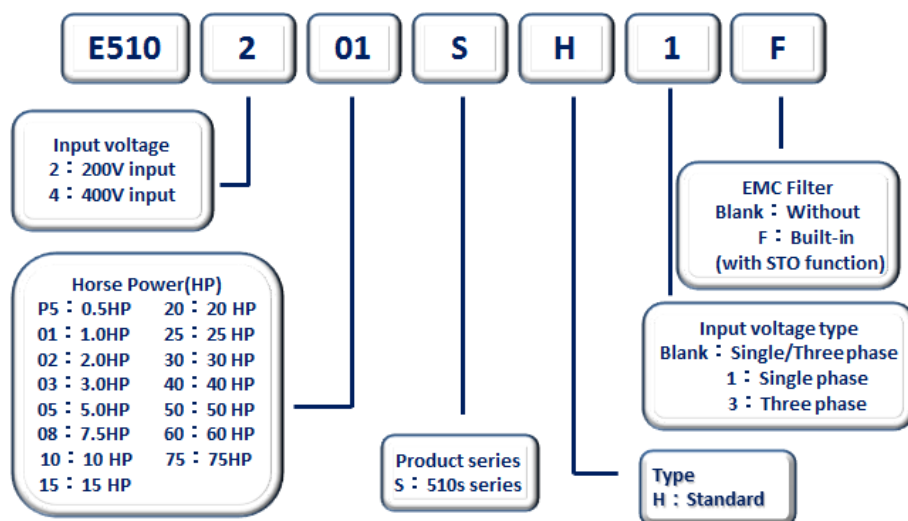

3.3 Model Identification

A B – CDE – F – G – HJ – K – L

A : Product	F : Standard voltage	H-J : Horse Power
1 : Inverter	1 : 100-120V	0P5 : 0.5HP
2 : SERVO	2 : 200-240V	001 : 1HP
3 : PLC	4 : 380-480V	075 : 75HP
B : UL Category	G : Phase	K : EMC Filter
0 UL Recognized	0 : Single/Three ph	0 : Not built-in
1 UL Listed	1 Single phase	3 : Built-in+STO
C-E : Serial number		L : Protection Level
001-999		0 : IP20
		3 : NEMA1

3.4 Product name /Model name cross reference

Model Name	Product Name	Model Name	Product Name	Model Name	Product Name
11-301-21-2P5-30	E510-2P5-SH1F	11-301-43-403-30	E510-403-SH3F	11-301-43-425-30	E510-425-SH3F
11-301-21-201-30	E510-201-SH1F	11-301-43-405-30	E510-405-SH3F	11-301-43-430-30	E510-430-SH3F
11-301-21-202-30	E510-202-SH1F	11-301-43-408-30	E510-408-SH3F	11-301-43-440-30	E510-440-SH3F
11-301-21-203-30	E510-203-SH1F	11-301-43-410-30	E510-410-SH3F	11-301-43-450-30	E510-450-SH3F
11-301-43-401-30	E510-401-SH3F	11-301-43-415-30	E510-415-SH3F	11-301-43-460-30	E510-460-SH3F
11-301-43-402-30	E510-402-SH3F	11-301-43-420-30	E510-420-SH3F	11-301-43-475-30	E510-475-SH3F

Table 3

4. Safety Stop / Safe Torque Off. (STO).

E510s STO is a functional safety feature that complies with the safety functions in adjustable speed drives according to IEC 61800-5-2 (type A safety component) and when put in use within a safety control system according to the required safety standards will provide safe Torque off (no output voltage) and Prevents an unintentional restart.

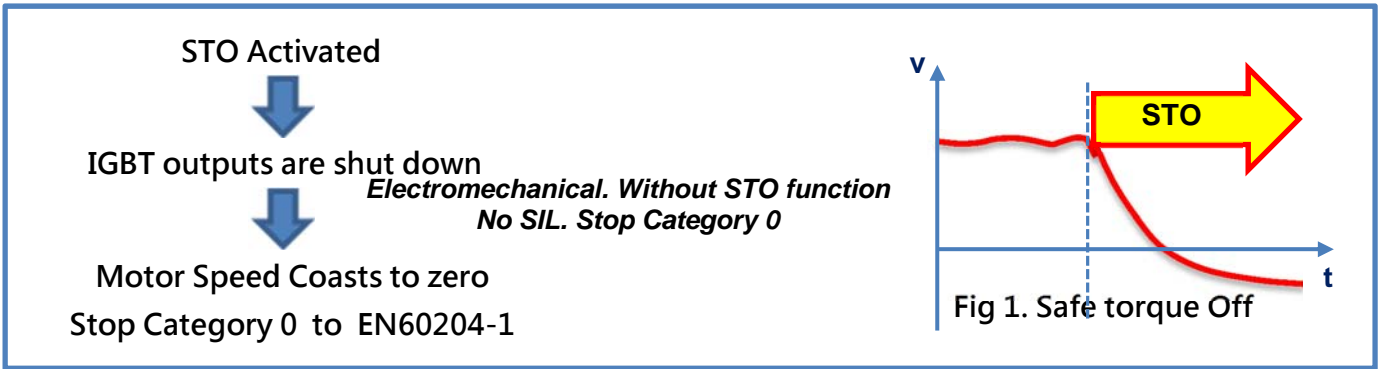

⚠ Caution

- The STO *Function by itself* is not an Emergency Stop and may be used as part of an Emergency Stop control system but all relevant standards must be consulted.
- Decision to use STO in a control system must be based on risk assessment, refer to the relevant standards EN/IEC 62061 or EN/ISO 13849-1.
- In application of STO due to the coast to stop function take into consideration the stopping time of the driven load.
- For further information on STO refer to EN61800-5-2 and For stop categories Refer to EN60204-1

5. Electromechanical and Safety integrated interface Comparison

Diagrams below show simple Inverter drive configurations for comparison between safe stop interfaces using electromechanical and Safety integrated type solutions.

***Electromechanical. Without STO function
No SIL. Stop Category 0***

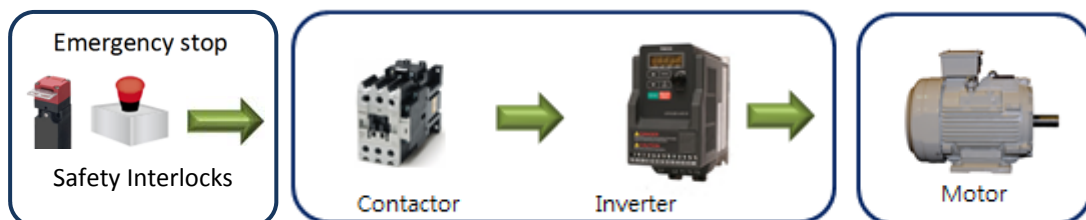

**Electromechanical. Without STO function
SIL 2. Stop Category 0**

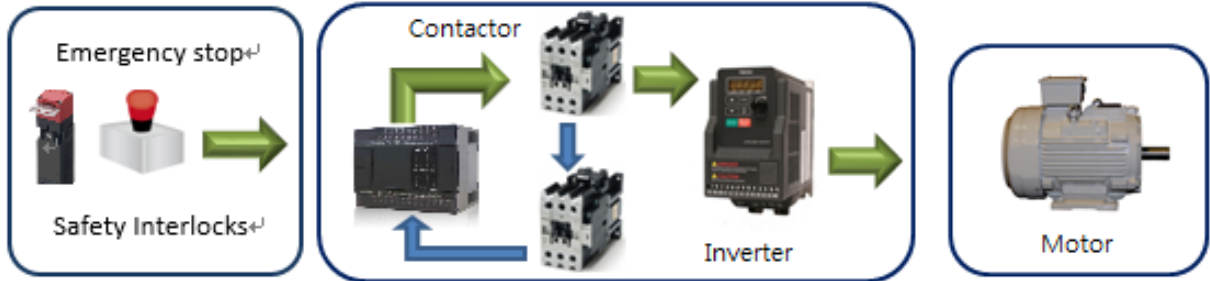

**Integrated STO FUNCTION
SIL 2. Stop Category 0**



6. Terminal designation & interface

6.1 Power & Control terminals.

Frame 1. Terminal layout is shown as a typical example.

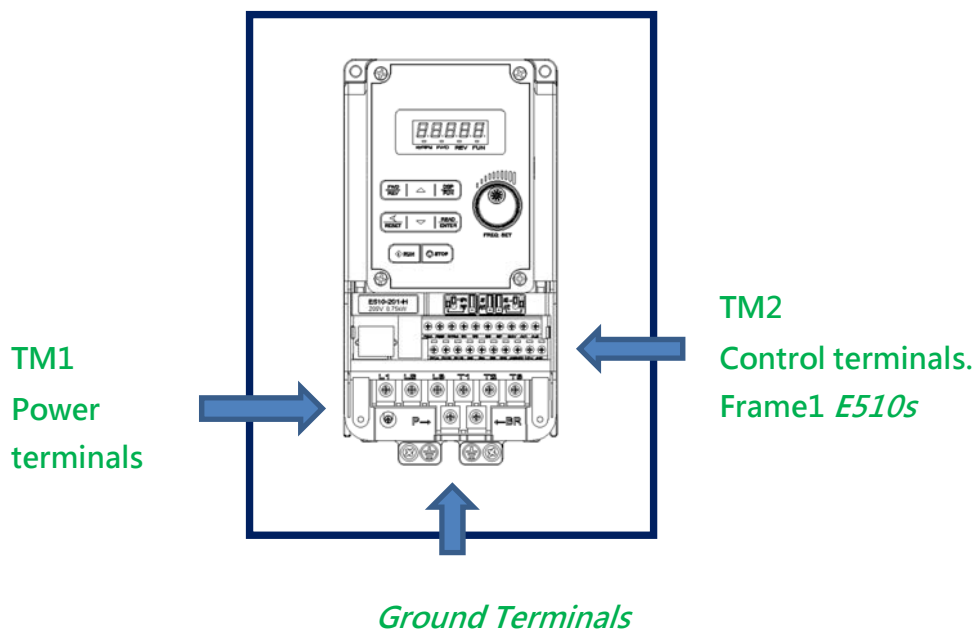

6.2 Control terminals & wiring

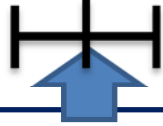
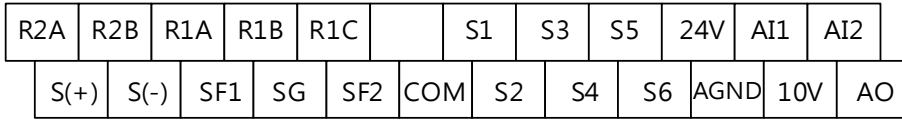

Safety Terminals. SF1 / SF2 & SG (Common).
Remove the jumper link for external interface

Terminal Symbol	Description	Rating
SF1	Safety Input 1 & SG connection. Open : Safe stop mode. Linked : Normal run mode.	Input resistance : 4.22kΩ Input Current : 5 to 6.5 mA Input Voltage : 21.6 to 26.4 V
SF2	Safety Input 2 & SG connection.. Open : Safe stop mode. Linked : Normal run mode.	
SG	Common terminal for S1, S2	+24VDC

Table 3. Safety related terminals

6.3 External 24Vdc supply (Connection option).

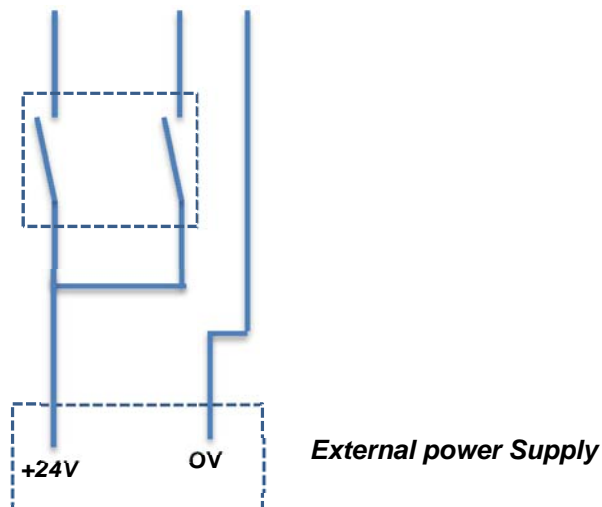
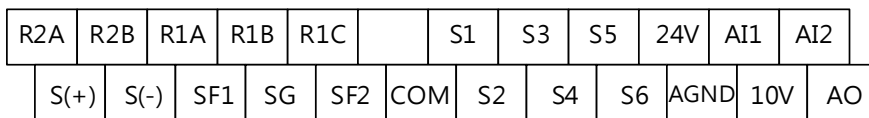

7. Safety Input logic & Status

TECO 11-301 safety stop function prevents a drive from supplying rotational energy to motors. Dual safety channels "S1" and "S2" cut off the gate-drive power for IGBT to turn off. Diagram below shows the basic block diagram design of the safety and interface for the safety inputs.

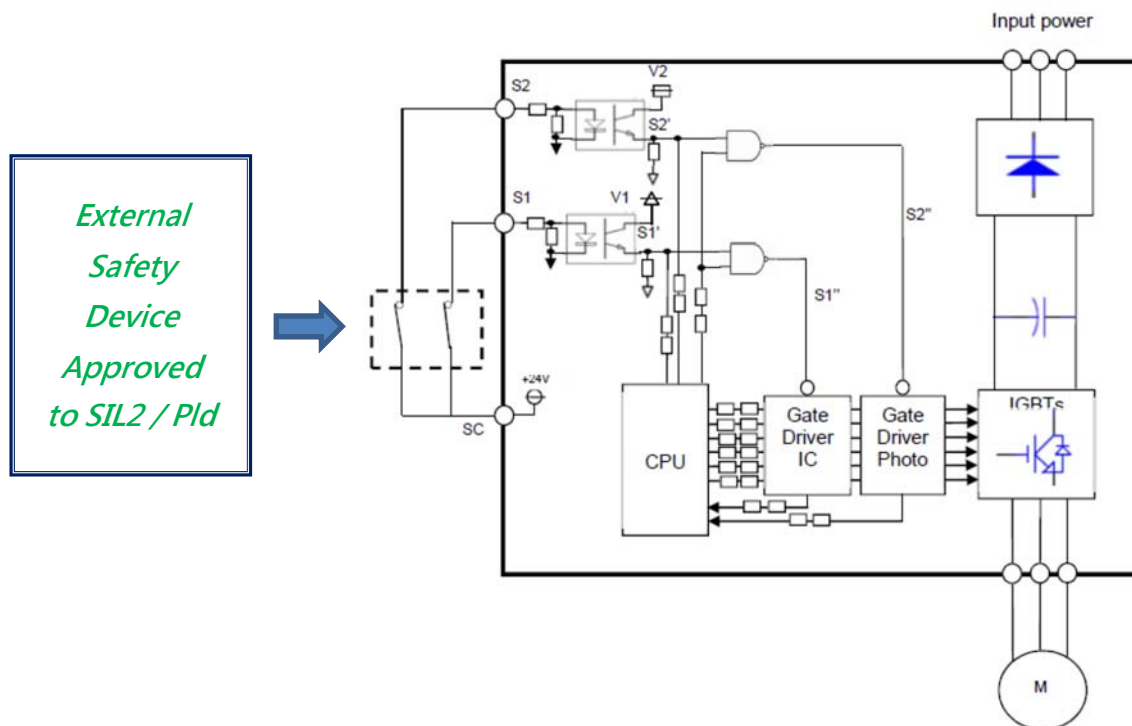

Figure 1 11-301 safety stop function diagram

WARNING

The safety stop function does not isolate electrically between drive and motor. To avoid an electric shock hazard, disconnect/isolate power to the drive and verify to ensure that the voltage is zero before performing any work on the motor (refer to your drive's *User Manual* for discharging time).

Directives

TECO 11-301 safety stop function meets the following directives and categories :

- ISO13849-1 : 2008 Category 3/PLd
- IEC62061 : 2005
- IEC61800-5-2 : 2007
- IEC61508 SIL2
- IEC60204-1 : 2006 Stop category 0

WARNING

The misuse of safety function leads to personal injury or death, property damage, or economic loss. To ensure that the system complies fully with requirement of safety, make a system-level risk assessment. TECO Electric Co. cannot assume responsibility for any system to comply with safety directive.

Installation and wiring

CAUTION

The following information is merely a guide for proper installation. TECO Electric & Machinery Co. cannot assume responsibility for the compliance or the noncompliance to any code, national, local or otherwise for the proper installation of this equipment. A hazard of personal injury and/or equipment damage exists if codes are ignored during installation.

CAUTION

Ensure the safety relay unit and the 11-301 unit is mounted closely in open type and all interconnection wiring is short and protected against open and short circuit faults. Refer EN/ISO13849-1.

Installation

TECO 11-301 safety stop function should be used under following condition and environment.

Table.1 The condition and environment for using safety stop function

Item		Condition
Temperature range	Operation	-10°C to +50°C inside distributor (without stick on type dust cover) -10°C to +40°C inside distributor (with stick on type dust cover)
	Storage	-20°C to +60°C
Ambient humidity		95%RH maximum (non-condensing)
Shock		1G. (9.8m/s ²) for 20Hz and below. 0.6G (5.88m/s ²) from 20Hz to 50Hz (Compliance with IEC 60068-2-6)
Altitude		maximum 1000m above sea level
Atmosphere		Indoors (without corrosive gas, flammable gas, oil mist, dust and dirt etc.)
Over voltage category		II or less
Pollution degree		II or less
Mounting		wall mounting / vertical orientation

CAUTION

In order to meet safety stop, an approved safety relay unit to ISO13849-1 safety category 3. In addition, all other components with in the safety stop loop shall be 'safety approved' types.

WARNING

To avoid an electric shock hazard, insert the magnetic contactor (MC) between power source and drive. Open the contact of MC and keep away from drive for discharging time (refer to your drive' s *User Manual* for information) before performing any work on the drive. And verify that the voltage on the bus capacitors has discharged before Measure the DC bus voltage at the P(+) and N(-) terminals or test points. (Refer to your drive' s *User Manual* for locations). The voltage must be zero.

CAUTION

To avoid systematic faults, a test even for faulty demands of the safety function has to be performed in order to check the correct function of the monitor signal. This test shall be carried out at system installation, any software changes, parameterization changes, and/or at least once per year. Refer to "Chapter 5 Troubleshooting and Fault Diagnostics" .

Wiring

The safety related terminals are described in Table.2 and Table.3

Table.2 The safety related terminals

Terminal Symbol	Description	Rating
S1	The function status of S1-SC terminal. Open: In safety stop mode. Short: :Non-safety stop mode.	Input resistance : 4.22kΩ Input Current : 5 to 6.5 mA Input Voltage : 21.6 to 26.4 V
S2	For function status of S2-SC terminal. Open : In safety stop mode. Short : Non-safety stop mode.	
SC	Common terminal for S1, S2 terminals.	

8. Safety Input Status

Table below shows the logic level status for external safety interface, internal circuit and drive output.

Table.3 Truth table of Safety related signals

+24VDC Power supply	External Safety Input Status		Internal safety circuit logic				Safety Circuit Failure	Drive Output Status OFF = Safe State ON= Enabled	Motor status
	SF1-SG	SF2-SG	S1'	S2'	S1''	S2''			
OFF	-	-	-	-	-	-	-	OFF	Stop
ON	OFF	OFF	L	L	H	H	Detected	OFF	Stop
	OFF	ON	L	H	H	L	Detected	OFF	Stop
	ON	OFF	H	L	L	H	Detected	OFF	Stop
	ON	ON	H	H	L	L	-	ON	Run

- The response time from safety stop signal input to drive shutoff is faster than 8ms.
- Hold the ON or OFF status for 1ms or longer to input signal to terminal S1 or S2.
- Signal input shorter than 1ms is not recognized.

Electric ratings of terminals

Model	Horsepower	Power Specification	Voltage (Volt)	Current (A)
Frame1	0.5/1	200V~240V	600	20
	1/2	380V~480V		
Frame2	2/3/5	200V~240V	600	45
	3/5	380V~480V		
Frame 3/4	7.5/10/15/20	200V~240V	600	100
	7.5/10/15/20/25	380V~480V	600	165
Frame 5	25	200V ~ 240V	600	100
	30	380V ~ 480V	600	75
Frame 6	30/40	200V ~ 240V	600	175
	40/50/60/75	380V ~ 480V	600	

Diagnostic

Safety stop function protection mechanisms :

Safety stop terminal (S1-S2-SC)contact short wire, Disable safety stop mode, Motor running ;

1. When S1-SC open and S2-SC short, at this time, protection signal will cut off driver unit enable pin, IGBT none PWM signal, motor free run;
2. Otherwise, When S1-SC short and S2-SC open, at this time, protection signal will cut off driver unit input power, IGBT none PWM signal, motor free run;
3. Safety stop terminal (S1-S2-SC)contact short wire, the motor running ,When photo-coupler secondary side of the power supply V1 & V2 occurs suddenly OV or UV, CPU detected abnormal voltage state , sent "LO" signal to NAND logic gate cutting off gate drive enable signals, motor free run.

Self diagnostic test

11-301 does the self-diagnostic test on the power-ON.

If 11-301 output alarm at power-ON, please take the action described in "Diagnostic" at above.

Test procedure for functionality

As depicted "ATTENTION" in above, the test for the functionality is important. Please do the test following procedure.

- (1) Please make each state of S1-SC and S2-SC depicted at Table.5.
- (2) If there is any different state from Table.5, 11-301 has some malfunction.
- (3) If there is no different state from Table.5, check the systematic performance, such as, press the Emergency switch, press the start/restart button at the failure detected (RUN-SE opened), and so on.
- (4) Finally clear the error record of the 11-301 (see the user manual how to clear the error record).

9. Safety design and specifications of 11-301

STO design main requirements

Safety Function Requirement Specification SIL2	
Initiating devices	User connected sensor or other safety devices
Hazard	Rotation of the motor (To be derived from hazard assessment)
Consequence	Human harm or damage to machinery.
Safe State	PWM removed, therefore No Voltage output from the drive.
Required Action	Detect Safe input signals and remove PWM signal.
Response Time	8ms (from STO input signal detection to the final action of STO)
Target SIL	SIL = 2, PL d, category 3
Demand Rate	High demand rate
Mode of Operation	Continuous
PFHD	The PFHD of STO function shall be less than 0.5×10^{-6}
MTBF	The MTBF of drive system shall be more than 100,000 hours
Trip Mode	De-energize to trip
MTTR	No more than 4 hours (No field repair, only change new board)

Parameter	Value
PFDAVG	2.58×10^{-4}
PFHD	1.18×10^{-8}
PL	d
MTBF	8,096 years
DCAVG	84%

Abbreviations:

SIL	Safety Integrated Level
PFHD	Probability of Dangerous failure Per hour
MTBF	Mean Time Between Failures
MTTR	Mean Time to Repair. (hour)

REVISIONS

Date	Manual Number	Revision
May 2017	4KA72X645T01	First edition



TECO Electric & Machinery Co., Ltd.

10F., No.3-1, Yuancyu St., Nangang District,

Taipei City 115, Taiwan

Tel : +886-2-6615-9111

Fax : +886-2-6615-0933

<http://industrialproducts.teco.com.tw/>



Distributor

4KA72X645T31 Ver:04 2020.11

This manual may be modified when necessary because of improvement of the product, modification, or changes in specifications, This manual is subject to change without notice.