

# MVCPLUS

# TECO



**MEDIUM  
VOLTAGE  
MOTOR  
CONTROLLER**

**5kV**  
CLASS

**7kV**  
CLASS

**15kV**  
CLASS

Advanced motor control,  
protection and monitoring in a reliable,  
field proven controller



P/N: TECO-MVCPLUS-0309-01

# MVC PLUS

**Expect peak performance from your critical medium voltage equipment when your motors are protected and controlled by MVC Plus Series Controllers**

## The Power of Performance

in an unpredictable world the MVC Plus Series protects both your motor and your load...

- Motor and controller protection is taken to a new level by combining a high-end motor protection relay with a heavy duty Motor Controller.
- Flexible control features and selectable ramping profiles to match any application... no need to compromise performance.
- High level circuit isolation via fiber optics (standard on all units) for safety and power quality immunity.
- Sealed NEMA 12 enclosures are standard equipment, not an expensive option.

### Control & protect any AC motor

the **MVC Plus Series** Controller is designed to start AC motors in any fixed speed application. It provides maximum protection with "True Thermal Modeling," while allowing smooth, stepless control of acceleration and deceleration. The MVC Plus Series guarantees power control and protection for your most important assets.

### Heavy-duty attitude

Highest rated power devices for maximum current carrying capacity. Rated at 500% for 60 seconds, the MVC Plus Series Controller will never be the limiting factor in your application. Powerfull sustained gate pulse insures reliable SCR firing without reactors (unlike "wimpy" pulse train designs that require a reactor to prevent SCR and motor damage).

### Experience where it counts

With over 500,000 low voltage and medium voltage Controllers in operation, we have the application expertise you need. No other controller manufacturer takes this product more seriously or has as much experience applying motor controllers. The **MVC Plus Series** is the pinnacle of product development and is recognized by users and OEMS around the world as the best Medium Voltage Controller on the market today.

### Designed for:

- Heavy loads
- Tough environments
- Any power conditions
- Reactor-less operation



## WITH THE FEATURES YOU NEED...

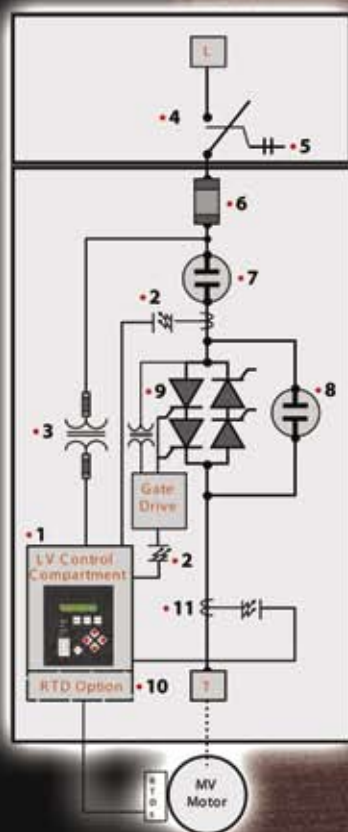

- 1 Advanced motor protection relay and ramp features programmable via the keypad or a laptop computer.
- 2 Fiber optically isolated low voltage compartment with up to 110kV BIL rating for safety and reliability.
- 3 Built-in 120V control power transformer\*; voltage and current metering.
- 4 Load-break / fault-make rated disconnect switch with door safety interlocking.\*
- 5 Visible grounding bar for safe operation.
- 6 Coordinated motor fuses with blown fuse indicators.
- 7 Line isolation vacuum contactor.\*
- 8 Fully rated bypass contactor for increased thermal capacity and optional across-the-line motor.
- 9 Heavy duty SCR stack assemblies with ring transformer isolation for reliable SCR gate firing.
- 10 RTD Option accepts up to 12 RTD inputs.
- 11 Zero sequence ground fault protection option.
- 12 Top entry, bottom exit with room for stress cones. Removable entry plates for easy connections.
- 13 NEMA 12 gasketed enclosure (NEMA 3R optional).

\*"Start Only" model available for retrofit applications. Does not include disconnect switch, line isolation contactor or CPT. Customer supplied line start panel required.

# MVC PLUS

Every facility has equipment critical to its operation and productivity. This equipment is often controlled by medium voltage AC motors.

The MVC Plus Series Motor Controller provides the highest standard of motor control and unsurpassed protection for these critical motor applications.

## ADVANCED PROTECTION

All the features of a motor protection relay without the added cost.

- **True Thermal Modeling** monitors the motor for excessive thermal conditions due to starting, running and even ambient conditions.
- **Retentive Thermal Memory** for continuous overload protection even after a complete power loss. When power is restored, the **MVC Plus** remembers the last thermal condition of the motor, observes the off time via a real-time clock and adjusts the thermal model accordingly.
- **Non-Volatile Memory** stores the thermal memory without the need for batteries.
- **True Time Thermal Tracking** adjusts the thermal model for different cooling rates based on motor temperature, running state or power loss.
- **Dynamic Reset Response** Reset is only allowed after the motor has sufficient thermal capacity for a successful restart.
- **Thermal Model Biasing** adjusts for heating effects of phase current imbalance or optional RTD inputs.

### FLEXIBLE SETUP

Choose the level of overload protection.

- **Programmable Trip Classes** selectable from NEMA/UL Classes 5 - 30.
- **Dual Mode Protection** separate trip curves for start and run modes (example: Class 20 for start, Class 10 for run).
- **Warning Levels** can be programmed and assigned to one of six built-in output relays.
- **Custom Trip Curve** programmable based on the motor manufacturer's data or it can use a "Learned Overload Curve" that reflects normal running condition with a programmable trip bandwidth.
- **Remote or Automatic Overload Reset** can be activated for unattended operations.

Motor Thermal Model

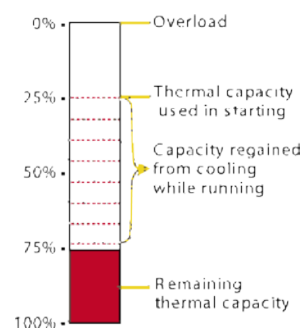

Dynamic Reset Response

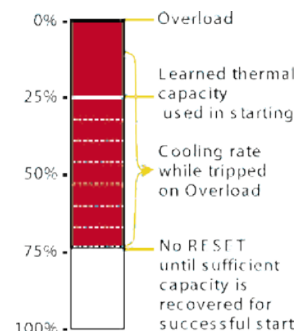

# MVC PLUS

The MVC Plus Series controller provides the system protection features found in expensive "stand-alone" Motor Protection Relays, without costly add-on cards or discreet devices.

- **Over Current /Electronic Shear Pin** trip and alarm safeguards your motor and equipment. Protects against jammed loads, sand in pumps, detects worn out blades, etc.
- **Under Current/Load** trip and alarm sensing detects an underloaded motor due to shaft/belt breakage or loss of prime in pumping systems.
- **Dual Mode Short Circuit Trip** (exclusive "toe-in-the-water" circuit) pre-checks the motor to prevent starting into a shorted load. In the Run mode, it becomes an "electronic fuse" tripping faster than most fuses and circuit breakers.
- **Phase Rotation, Phase Loss and Current Imbalance Protection**
- **Under Voltage, Over Voltage and Line Frequency** trips and alarms protect against power problems from the utility or generator.

ANSI / IEE Number	System/Protection Features	Standard
19	Reduced voltage soft start	✓
27	Under voltage	✓
37	Undercurrent	✓
46	Current imbalance	✓
47	Phase rotation	✓
48	Locked rotor / Incomplete sequence	✓
49	I <sup>2</sup> t electronic motor overload	✓
50	Instantaneous electronic over current trip	✓
51	Over current	✓
55	Power factor trip	✓
59	Over voltage protection	✓
66	Starts per hour and time between starts	✓
81	Frequency variance	✓
86	Lockout / start inhibit	✓
50N/51G/N	Ground fault detection, instantaneous and current	Optional
49/38	Stator and bearing RTD protection	Optional
14	Speed switch and tachometer trip	Optional

## Ground Fault Option

Zero Sequence ground fault protection can be provided to protect equipment from damage due to faulty grounded conductors or motor windings. Separate High (fast) and Low (slower) trip points and alarm levels are available to help prevent nuisance trips. The ground fault protection CT uses a fiber optic connection for safety isolation.

## RTD Input Option for Precise Thermal Management

Thermally biased, programmable RTD inputs can be multiple types and can be individually named. Each RTD can be assigned to an output relay with different values for alarm or trip. Temperatures are recorded to the fault history and can be used to activate warning or trip relays based on setpoints. 12 RTD inputs can be configured in software to match the RTD material used and can be monitored at the keypad or remotely.

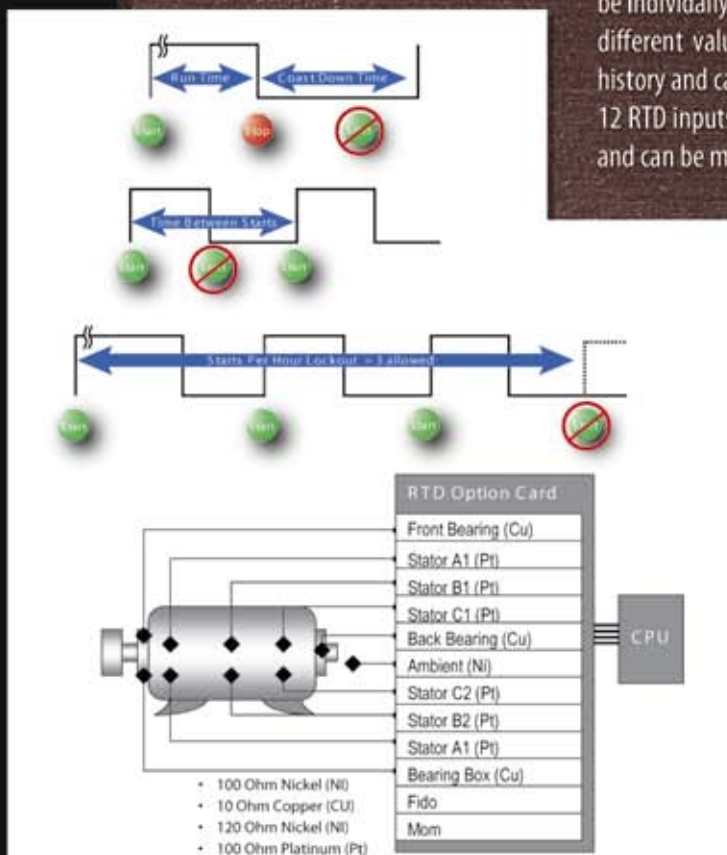

## Real-time Clock Features

- **Coast Down/ Back Spin Lockout** (programmable up to 60 minutes) prevents a start attempt when the motor / load is backspinning when the motor is turned off.
- **Elapsed Time Metering** indicates run time for scheuled maintenance or trouble shooting help.
- **Time Between Starts Lockout** eliminates motor and equipment damage caused by repeated start commands.
- **Time and Date Stamping** of faults for precise recoring of what happened when.
- **Starts-per-Hour Lockout/Short Cycle Timer** allows you to program the maximum number of starts per hour and provides a programmed "wait time" (0 - 60 minutes) between start attempts.

## Start it Soft... WORK IT HARD!

Choose the acceleration ramp that is best for your application with the flexibility of microprocessor based ramp control.

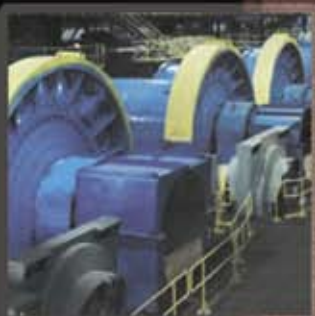

### Pumps, Fans, Blowers & Conveyors

- Closed Loop Torque (CLT™) using PID algorithms is ideal for deep well pumps or systems where the load conditions change from one start to the next.
- Linear Speed Ramping can be achieved by adding a tachometer feedback signal from the motor.

### Compressors & Chillers

- Voltage Ramp with Current Limit for applications that need the smoothness of voltage ramping while maintaining the ability to start in limited power environments.
- For maximum motor power where the available power supply is severely limited, a Current Limit/Current Step start can be used.

### Process Machinery

- The Jog function can be used in initial machine setup. Apply just enough voltage/torque to rotate the motor shaft without accelerating to full speed.
- Dual ramps are built-in, allowing for different load conditions and ramping requirement.

### Generator Powered & Mobile Equipment

- Protect the integrity of your process even when power conditions are less than perfect.
- Reliable SCR firing even during frequency drift that may occur with portable equipment or backup generators.
- No need for reactors, regardless of motor lead length or system capacity.

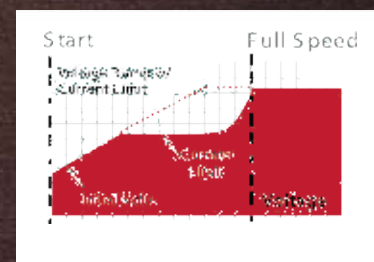
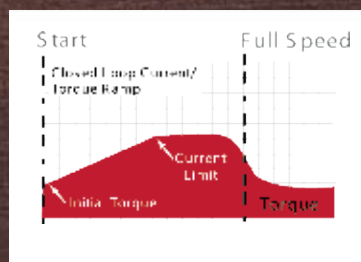

## Pump-Flex™ CONTROL

### Custom Acceleration Curves can be

programmed to match your pump and hydraulic conditions. Select up to eight time and torque points for smooth acceleration of your pump without surges or undue motor thermal stress. Three selectable custom curves can be programmed to accommodate changing load/pump conditions or for different processes.

### Pump-Flex™ Decel Control

is a standard feature of the MVC Plus Series and a key reason for choosing Motor controllers over other more traditional methods of motor control.

### Experience the difference - Pump-Flex™ Decel

A gradual reduction in the output torque of your pump motor is provided when a stop signal is initiated. When the motor output reaches a point where the check valve can be safely and gently closed, the Pump-Flex™ circuit automatically turns itself off. No need for external timers or auxiliary controls.

### Maximize performance

Since no two pumps or pump applications are exactly the same, the flexible settings of Pump-Flex™ decel control allow you to tailor the output to precisely match your application requirements.

### Eliminate the damaging effects of "Water Hammer"

When traditional electro-mechanical motor controls are used, motor torque is immediately lost when the power is turned off. The fluid that is flowing through the system, and the kinetic energy associated with it, immediately reverses direction. To prevent the reverse flow, a check valve typically is slammed shut, trapping the kinetic energy in the piping system. This creates a shockwave often referred to as "Water Hammer."

### Minimize maintenance costs & downtime

By gradually reducing motor torque using Pump-Flex™ decel control, this potentially destructive pump output pressure is allowed to slowly dissipate in the system during the stopping process. Check valves close gently and other fluid system components including pipes, valves, flanges, couplings and hangers are no longer subjected to the shock and destructive potential of water hammer.

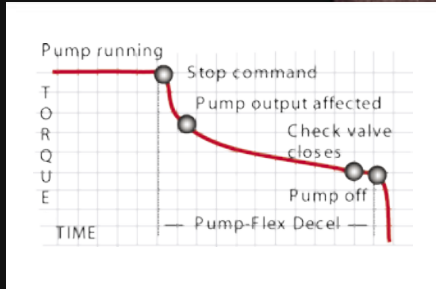
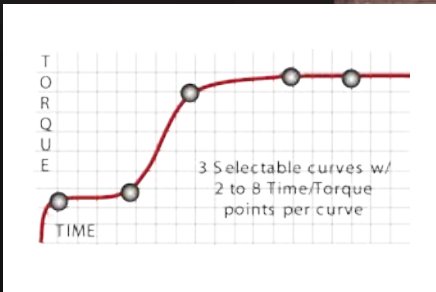

### for Soft Starting & Soft Stopping

- Unique to Motor Controllers
- Eliminate "Water Hammer"
- Minimize Downtime
- Reduce Maintenance Costs

# MVC PLUS

## CUSTOMIZED Line-ups



The standard Class E-2 MVC Plus Series controller design can be packaged as a "building-wide solution".

Medium voltage MCC line-ups or stand-alone controllers customized to meet your application needs.

- Main disconnects
- Main-tie-mains
- Incoming line sections
- Transformer feeders
- Across-the-line Motor Controller
- VFD bypass isolation
- Coordinated key interlocks
- Multiple motors on one Motor Controller
- PFC capacitor control
- Reversing or 2-speed motors
- SCADA communications
- Cone valve logic control
- Conveyor controls
- PLC Logic



# MVC PLUS

## DESIGNED TO YOUR PROJECT SPECIFICATIONS

### Medium Voltage Control Centers

#### Typical 5kV MCC options:

- Incoming/pull sections 18", 24" or 36" wide
  - Busbars 800A, 1200A, or 2000A  
Tin plated copper  
Braced for 78kA fault withstand
  - Safety key interlocks
  - Main fused disconnects 400A, 600A or 1200A
  - Auxiliary across-the-line Motor Controller
  - Control sections 24" or 36" wide
  - Feeder switches 400A, 600A or 1200A
  - Protection relays and other accessories
  - Low voltage transformers
  - AC drive bypass isolation
  - PLC logic control
  - Power factor correction capacitor controls
  - Custom packaging with draw-out switch gear
- Contact factory for 7kV and 15kV application requirements.



4160V, 1000A Motor Controller with Synchronous Controller for 10,000 HP gas compressor.



4160V, multi-motor Controller designed to simultaneously start (3) 600HP conveyor motors.

### Specialty Motor Applications

- **Synchronous Exciter**  
The **MVC Plus Series** can be integrated with synchronous exciters in both brush and brushless packages.
- **Wound Rotor**  
Apply the exact rotor resistance needed for your application, while soft starting the stator with the **MVC Plus Series**.
- **Reversing or 2 speed**  
Controls can be built-in, or the **MVC Plus Series** can be retrofitted behind existing 2 speed controllers.
- **Inching / Spotting Control**  
For low speed load positioning to line up access ports, test blade positions, etc.
- **Multiple Motor**  
Control and protect multiple motors from one controller

# MVC PLUS

Specifically designed for ease of integration into automated systems, the MVC Plus Series offers communications and flexible I/O as standard

## Advanced INTEGRATION

### Flexible I/O

- 120Vac control power input accepts long control circuit runs without the need for interposing relays.
- 8 programmable relay outputs for control flexibility without the need for external auxiliary relays or add-on cards.
- 2 programmable analog outputs (0 - 10Vdc or 4 - 20mA).

### Communication Ready

#### Built-in comm ports

- RS-232 for one on one communications with a PC.
- RS-485 for multi-drop communications with Modbus RTU protocol as standard.

#### Multi-Drop

For on-line monitoring, control and programming, the MVC3 Control Center software uses the standard RS-485 port to communicate via Modbus RTU protocol. Multidrop compatible for communicating with multiple units in the field, global data such as operating currents, voltages, power factor, etc. can be displayed for each unit. Individual parameters for any selected unit are displayed in the lower right section of the screen, and are fully interactive in real time. Anything that can be done at the unit can be done via software. Communications options include DeviceNet, Fieldbus, Ethernet and several others.

#### One to One

Program and store controller setpoints with Windows based software, MVC3-Win. The software uses the RS-232 port to duplicate the operator interface on the screen and steps through the setup or storage of operating parameters.



### Type of Load

3-phase medium voltage AC induction or synchronous motors

### AC Supply Voltage

2300, 3300, 4160, 6000/7200V, 11-15kV

VAC +10% to -15%, 50/60 Hz line voltages

### HP Ratings

Up to 10,000 HP @ 7.2kV (1500 Amps)

Up to 20,000 HP @ 15kV (800 Amps)

Contact factory for higher rating requirements

### Overload Rating

AC53b 600-30-60m

### Power Circuits

Series strings of SCR power modules (1, 2 or 3 matched pairs of SCRs per phase depending on voltage rating)

### SCR Peak Inverse Voltage

Line Voltage	PIV Rating	Line Voltage	PIV Rating
2300	6500	6500	19500
3300	9000	6900-7200	26000
4160	13000	11000	27000
6000	18000	13-15kV	39500

### BIL Rating

2300V - 7200V 60kV

11000 - 15000V (110kV)

### Transient Voltage Protection

dv/dt circuits (1 per SCR pair)

### Vacuum Bypass Contactor

Standard on all models, line start rated

### Ambient Operating Conditions

0 - 50°C (82° F to 122° F) (Optional -20° to 50° C with heaters)

5 - 95% relative humidity

0 - 3300 ft (1000m above sea level without derating)

### Digital Control Unit (DCU)

Programmable keypad/operator with 2 lines x 20 character backlit LCD display. Status/Alarm

LEDs (indicate: Power, Run, Alarm, Trip, Aux 1 - 8)

### Auxiliary Contacts

Multiple Form C contacts rated 5A @ 250VAC max.

6 fully programmable relays (including fail-safe operation)

5 dedicated relays (fault, at-speed, etc.)

### Programmable Features

Motor FLA, service factor, insulation class

Dual Ramp Adjustments - Two independent settings for:

- Initial Torque 0 - 100% of nominal torque, voltage or current

- Current Limit 200 - 600% of motor FLA

- Acceleration Time 1 - 120 seconds

Three Custom Curves Via plotted torque/time axis points

Pump-Flex™ Decel 1 - 60 seconds with begin & end torque adj

Kick Start 0.1 - 2.0 seconds (10 - 100% voltage)

Tach Feedback (option) Closed loop speed ramp

### Motor and Controller Protection

Electronic Overload

Phase Loss

Phase Imbalance

Phase Reversal

Short Circuit Detection

Over / Under Current

Over / Under Voltage

Shorted SCR / Shunt Trip

Controller Over-Temp

Coast Down Lockout

Starts per Hour Lockout

Time between starts

RTD Input (Option)

Ground Fault (Option)

### Statistical Data

Elapsed run time, last start time, average starting current, stores history of up to 60 events (data includes date & time, phase & ground fault current). Also displays time-to-trip, remaining inhibit time and starts/hour values.

### Metering (Voltage & Current)

Percent of FLA, phase currents, kVAR, kVA, kW, power factor, demand, avg. start current, remaining thermal register, thermal capacity to start, measured capacity to start, time since last start, line frequency, phase order, RTD values (optional)

### Enclosure

NEMA 12 with 3R optional (not for direct sun applications), top and bottom entrance plates, 11 gauge steel, ASA #61 gray powder coated paint.

### Communications

RS485 with Modbus RTU protocol or RS232 with windows interface.

### Certifications

Standard model provide CE only, others certifications available for option.



Ratings				Std MVC3 Class E2 Motor Controller				Optional Motor Controller Only			
Volts	Max. Amps	Nominal Max. HP	KW	Model	NEMA 12/3R			Model	NEMA 12/3R		
					H	W	D		H	W	D
2300	200	800	500	MVC3-23200-E-SWG	92	36	30	MVC3-23200-E	92	36	30
	400	1500	1000	MVC3-23400-E-SWG		36		MVC3-23400-E			
	600	2500	1900	MVC3-23600-E-SWG		72		MVC3-23600-E			
3300	200	1000	600	MVC3-33200-E-SWG	92	36	30	MVC3-33200-E	92	36	30
	400	1800	1200	MVC3-33400-E-SWG		36		MVC3-33400-E			
	600	3000	2200	MVC3-33600-E-SWG		72		MVC3-33600-E			
4160	200	1250	1000	MVC3-41200-E-SWG	92	36	30	MVC3-41200-E	92	36	30
	400	2500	2000	MVC3-41400-E-SWG		36		MVC3-41400-E			
	600	5000	3750	MVC3-41600-E-SWG		72		MVC3-41600-E			
6000/ 7200	200	2500	2000	MVC3-60200-E-SWG	92	72	30	MVC3-60200-E	92	36	30
	400	5000	3750	MVC3-60400-E-SWG				MVC3-60400-E			
	600	7500	5600	MVC3-60600-E-SWG				MVC3-60600-E			
11 - 15KV	300	7500	5700	MVC3-130300-E-SWG	Contact factory			Contact factory			
	600	15000	11000	MVC3-130600-E-SWG							

\* Larger Units Quote on Request



THE COMPANY

Your best choice for Motor Controls is a company that provides you with the attention, innovation and quality you deserve and these things can only come from a company dedicated to that one endeavor. We do one thing and we do it well, and with more field experience than any other motor control manufacturer that offers Motor Controls. Our range of AC motor starting products is second to none with a commitment to quality in design.

THE PRODUCTS

At TECO, we believe in designing all of our products to be capable of controlling even the toughest loads. This "Heavy Duty Attitude" provides our customers with the greatest reliability, the most flexibility and the highest value for their electrical control budget.



THE PEOPLE

TECO headquarters in Taipei City, Taiwan, provides an experienced and knowledgeable Customer Service, Technical Support and Engineering staff to complement our manufacturing capabilities. Local support can also be obtained through our distributors and regional offices located in key industrial areas around the world.

No matter how you choose to start or protect your motor, you can always expect the best from TECO... in our products, our prices, our service and our support.



www.teco.com.tw



Head Office, Sydney

TECO Australia Pty Ltd  
335-337 Woodpark Road,  
Smithfield NSW 2164  
Tel: 02 9765 8118  
Fax: 02 9604 9330



Melbourne

TECO Australia Pty Ltd  
16 Longstaff Road,  
Bayswater VIC 3153  
Tel: 03 9720 4411  
Fax: 03 9720 5355



Brisbane

TECO Australia Pty Ltd  
50 Murdoch Circuit,  
Acacia Ridge QLD 4110  
Tel: 07 3373 9600  
Fax: 07 3373 9699



Perth

TECO Australia Pty Ltd  
28 Belgravia Street,  
Belmont WA 6104  
Tel: 08 9479 4879  
Fax: 08 9478 3876



New Zealand

TECO New Zealand Ltd  
Unit 3, 477 Great South Road,  
Penrose, Auckland  
Tel: 64 9-526 8480  
Fax: 64 9-526 8484  
sales@teco.co.nz

Distributor