

MONARCH



Low Voltage 3-Phase Induction Motors | Range
0.55kW to 500kW

TECO 

AUSTRALIA & NEW ZEALAND

TOTALLY ENCLOSED FAN-COOLED CAST IRON FRAME SERIES

General Information

MONARCH GX - Three Phase Induction Motors are a range of high quality, Totally Enclosed Fan Cooled (TEFC), Squirrel Cage Induction motors, designed, manufactured and tested to the latest International and Australian Standards.

There are two main motor types -

Types	Enclosure Protection	Insulation Class	Shaft seals	Finish Colour
MONARCH	IP55	F	"V" ring	TEAL
MONARCH Severe Duty	IP66	H	Gamma	BLUE JADE

Electrical Design and Standards

Altitude

Designed for operation at an altitude up to 1000 metres above sea level (please refer to TECO sales offices for higher altitudes).

Ambient

Motors are designed to operate in ambient conditions of -20°C to +40°C as standard. Operation in adverse ambient conditions should be referred to TECO.

Direction of Rotation

Standard rotation is clockwise when viewed from the drive end with the terminal markings corresponding to incoming line markings.

Duty Rating

All motors have a maximum continuous duty rating of S1 to AS60034.1. Other duty ratings are available on request.

Electric Supply

Stock motors are designed for operation on a 380~415 Volt 3 phase 50 Hz supply and are also suitable for a 440~480 Volt 3 phase 60 Hz supply.

Motors 3 kW and below are 380 - 415 Volt 50 Hz STAR connected and may also be reconnected to 240 Volt 3 phase 50 Hz DELTA configuration for use with single phase input Variable Speed Drives.

Motors 4 kW and larger are 380 - 415 Volt 50 Hz DELTA connected. Motors can be manufactured for supply systems of up to 1100 Volts, 50 or 60 Hz on a factory made to order basis or by local rewind / wind.

Motor Types / MEPS (Minimum Efficiency Performance Standard)

All motors meet or exceed the Minimum Efficiency level requirements of the Australian / New Zealand Standard "AS/NZS1359.5-2004" to Table B2 where applicable.

Performance

Motors are designed to meet the performance requirements of Design N as per AS60034.1, normal torque for Direct On Line starting.

Motors are also suitable for other means of starting, depending on load characteristics, please refer to TECO.

Motors can be manufactured to provide special performance characteristics to suit specific applications as required.

Standards

Motors are designed, manufactured and tested in accordance with AS1359, AS60034, IEC60072 with Quality Assurance to ISO9001. Frame sizes are to AS1359.30 CENELEC HD231 allocations. However, there are some exceptions where motors are designed to meet the AS/BS frame allocations AS1359 as detailed in "Performance Data" on pages 5-7, and Dimensions on page 8.

Stator and Windings

High grade insulated cold rolled electro magnetic steel laminations.

Standard insulation is Class F insulation (155°C) with the Severe Duty model utilising full Class H materials (180°C).

Windings are designed with a maximum temperature rise of class B for long motor life and thermal reserve for abnormal conditions. Windings are random wound double enamelled copper wire, impregnated with a solventless resin and all motors are tropicalised as standard.

Testing

In addition to a full program of tests during manufacture each motor is subjected to routine tests to AS60034.1 prior to despatch.

Two Speed Motors

Available ex stock are a variety of two-speed motors for variable torque applications (Centrifugal pump / Fan).

Pole configurations

Poles	2 / 4	4 / 8	4 / 6	6 / 8
Winding	Tapped	Tapped	Dual	Dual

Mandatory mounting and shaft dimensions are as per this catalogue, however overall Two Speed dimensions differ for 80 - 132 frames. Please refer TECO for outline drawings.

Stock motor connection diagrams

DUAL WOUND (Y/Y)



LOW SPEED (Y)
SUPPLY TO 1U, 1V, 1W

HIGH SPEED (Y)
SUPPLY TO 2U, 2V, 2W

TAPPED WOUND (Y/Y)

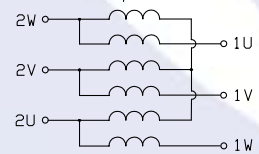

LOW SPEED (Y)
SUPPLY TO 1U, 1V, 1W

HIGHT SPEED (Y)
LINK 1U, 1V, 1W
SUPPLY TO 2U, 2V, 2W

Refer to page 7 for performance data, other output powers and performance data is on request.

Variable Speed Drive (VSD) suitability

Motors are suitable for VSD duty, subject to torque and speed limitations depending on the load characteristics and correct installation of motor and drive. EDM protection can be provided as a modification when requested.

Winding Protection

Single speed motors frame sizes D160 and larger are fitted with PTC thermistor protection (P140) within the windings, one per phase, connected in series with the leads terminated in the main terminal box.

Thermistors are an optional extra on all two speed motors.

Mechanical Design and Standards

Balance

All rotors are dynamically balanced with a half key to Class N or better, in accordance with AS1359.114.

Bearing and Lubrication System

Frame size	Poles	DE Bearing	NDE Bearing	Greasing
D80 ~ D160	All	Ball	Ball	Greased for life
D180 ~ D400	2	Ball	Ball	Grease relief
D180 ~ D225	4 and above	Ball	Ball	Grease relief
D250 ~ D355	4 and above	Roller (Ball)	Ball	Grease relief
D400	All	Ball (Roller)	Ball	Grease relief

Notes:

- (Items in the parentheses are alternatives).
- 2 Pole motors up to D180 are suitable for direct drive or belt drive.
- 2 Pole motors D200 and larger are suitable for direct drive, belt drive above D200 please refer to TECO.
- Stock motors 4 Pole and larger, up to and including D355 are suitable for direct drive or belt drive.
- D400 4 Pole and slower, please refer to TECO with drive details for correct bearing selection.
- Grease Relief system enables motor to be re-greased during operation.
- V-ring shaft seals are standard but metal backed Gamma seals are used on the Severe Duty models.

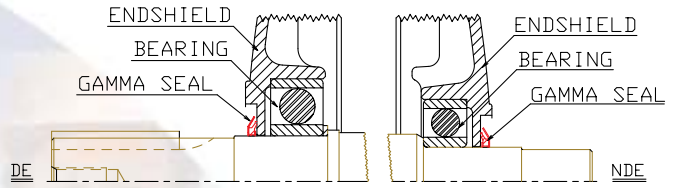

SEVERE DUTY BEARING ARRANGEMENT WITH GAMMA SEALS

Cooling System

- Cooling is Totally Enclosed Fan Cooled (TEFC), with integrally cast cooling fins on frame and is fitted with external fan (IC411) to AS1359.106.
- The cooling fans are bi-directional and low noise as standard (larger 2 pole may have uni-directional fans for low noise).

Finish

- All castings are mechanically cleaned and de-greased.
- Cast Iron components are primed internally and externally with an epoxy red oxide primer.
- Two finish coats of matt acrylic resin are applied providing a high corrosion protected surface. Finish colour TEAL T63 (standard), GLOSS BLUE JADE T24 (Severe Duty), colours are to AS2700.

Hardware

- All hardware is electro zinc plated for better corrosion resistance.
- Stainless steel hardware can be offered as an alternative, please contact TECO for the surcharge to provide this feature.

Mounting

- Motors are available in the following mountings -
- Foot mounted
- Foot and Flange mounted
- Flange mounted
- Foot and C Face mounted
- C Face mounted

Motor Construction

- Cast Iron frame with integrally cast feet and cast iron end shields.
- Castings are machined to close tolerances for accurate alignment and minimum vibration.
- External cooling fan is polypropylene and some larger size motors utilize metallic fans.
- Fan cover is pressed steel.

Rating Plate

- A stainless steel rating plate containing all details as specified in AS1359.4 including bearing sizes is fitted to all motors.

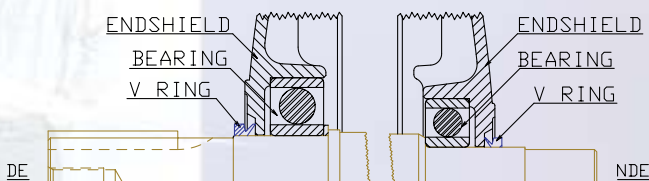

STANDARD BEARING ARRANGEMENT WITH V RING SEALS

Rotor Assembly

- High grade insulated cold rolled electro magnetic steel laminations.
- Rotor cage is pressure die cast high conductivity aluminium with waffer blades and balance supports integrally cast onto the rotor endrings.
- The rotor is pressed and keyed (on larger motors) to a high tensile steel shaft.

Smoke Spill

- Smoke Spill to AS1668.1:1998 is available on modified stock motors, direct driving axial fan, cooling IC418.
- Motor sizes available are D80 ~ D280, 4 pole and slower, single or multi-speed and have been tested in conjunction with TECO Variable Speed Drives to AS4429-1999 for either dual purpose or emergency use.

Time / temperature ratings

Rating	Time (minutes)	Temperature (°C)	Motor Insulation Class
1	120	200°C	F
2	30	300°C	H

Terminal Box

- Terminal box is top mounted on motor frame with all metal to metal joints provided with neoprene gaskets.

- Base – Lid surfaces are machined and fitted with one-piece neoprene gasket providing terminal boxes with an IP66 rating and has a "wrap over" casting on lid.
- Terminal box can be rotated in 90° steps through 360° for alternate cable entry orientations.

Options

- Some available options in this range are as follows:
- Airstream rated IC418
- Anti-condensation heaters
- Auxiliary terminal boxes for Thermistor / Heater / RTD terminations
- Cooling Tower application
- Double / non standard shaft extensions
- Electromechanical "fail safe" Brake Motors
- Encoder / Tacho
- Force cooling IC416
- Insulated bearing
- IP56, IP65 & IP66 enclosure
- Multi-speed motors, certain 2 speed motors are ex stock
- Resistance temperature detectors (RTD's) winding and / or bearing
- Rotor Groundary brush
- Smoke Spill
- Special paint systems / colours
- Stainless steel fasteners
- Thermistor protection (on motor frames <D160)
- Others on request



MONARCH GX - Severe Duty

TYPICAL PERFORMANCE DATA

CAST IRON TEFC THREE PHASE SQUIRREL CAGE INDUCTION MOTORS
MONARCH GX RANGE 80 - 400L FRAME (415V 50Hz)

OUTPUT kW	FULL LOAD RPM	FRAME NO.	EFFICIENCY			POWER FACTOR			CURRENT		TORQUE			INERTIA ROTOR J = GD2/4 kg-m2	dB(A)	WEIGHT foot mount (kg)
			FULL LOAD (%)	3/4 LOAD (%)	1/2 LOAD (%)	FULL LOAD (%)	3/4 LOAD (%)	1/2 LOAD (%)	FULL LOAD (A)	LOCKED ROTOR (%)	FULL LOAD Nm	LOCKED ROTOR %FLT	BREAK-DOWN %FLT			
0.55	1430	80	80.7	80.8	78.2	75.0	65.0	53.0	1.3	650	3.67	220	220	0.0016	50	20
	885	80	65.0	68.5	65.7	71.0	61.0	47.0	1.45	470	5.91	190	210	0.0026	46	21
	710	90L	73.5	74.4	71.3	61.0	51.0	39.0	1.74	400	7.50	180	200	0.0053	48	31
0.75	2855	80	80.5	81.5	79.4	83.0	75.0	62.0	1.56	680	2.51	220	230	0.0010	59	18
	1430	80	82.2	82.2	79.3	75.0	66.0	53.0	1.76	660	5.00	220	220	0.0020	50	21
	950	90S	77.7	78.8	75.7	72.0	59.0	47.0	1.81	590	7.56	200	210	0.0038	49	23
	710	100L	73.5	75.7	72.8	67.0	58.0	44.0	2.33	400	10.2	180	200	0.0078	51	33
1.1	2860	80	82.2	84.8	83.4	83.0	76.0	64.0	2.22	720	3.68	220	230	0.0013	59	20
	1440	90S	83.8	83.8	81.9	77.0	67.0	55.0	2.54	680	7.31	230	230	0.0030	53	26
	950	90L	79.9	82.0	79.2	73.0	63.0	51.0	2.62	590	11.1	200	210	0.0053	49	31
	710	100L	76.3	79.1	76.9	69.0	59.0	45.0	3.18	500	15.0	180	200	0.0107	51	38
1.5	2885	90S	84.1	85.2	83.5	85.0	79.0	69.0	2.95	750	4.96	220	230	0.0020	64	25
	1440	90L	85.0	85.4	83.5	77.0	68.0	55.0	3.32	700	9.96	230	230	0.0038	53	31
	955	100L	81.5	81.3	78.7	75.0	62.0	50.0	3.51	600	15.0	200	210	0.0107	53	38
	700	112M	78.4	80.8	79.4	69.0	61.0	47.0	3.86	500	20.5	180	200	0.0162	53	52
2.2	2875	90L	85.6	86.8	86.0	85.0	81.0	71.0	4.21	760	7.28	220	230	0.0026	64	29
	1450	100L	86.4	86.1	84.3	81.0	73.0	61.0	4.43	740	14.5	230	230	0.0077	56	40
	955	112M	83.4	84.3	83.0	76.0	67.0	56.0	4.96	650	22.0	200	210	0.0151	57	52
	715	132S	80.9	82.9	81.8	71.0	65.0	51.0	5.33	600	29.5	180	200	0.0331	53	67
3	2880	100L	86.7	88.2	88.0	87.0	86.0	78.0	5.53	810	9.96	220	230	0.0042	68	39
	1450	100L	87.4	87.0	84.5	81.0	71.0	59.0	6.12	740	19.8	230	230	0.0093	56	44
	970	132S	84.9	86.0	83.9	76.0	67.0	55.0	6.47	680	29.6	210	210	0.0318	61	67
	715	132M	82.7	84.4	83.1	71.0	62.0	49.0	7.01	550	40.0	200	200	0.0440	56	80
4	2910	112M	87.6	87.4	86.7	88.0	85.0	76.0	7.22	830	13.1	220	230	0.0058	69	50
	1455	112M	88.3	88.0	86.0	82.0	72.0	59.0	8.08	750	26.3	230	230	0.0128	57	58
	970	132M	86.1	88.3	87.7	76.0	69.0	56.0	8.73	690	39.4	210	210	0.0394	61	78
	720	160M	84.2	88.0	87.5	73.0	69.0	60.0	8.9	600	54.6	190	210	0.0771	60	105
5.5	2920	132S	88.5	89.8	89.0	88.0	85.0	77.0	9.94	830	18.0	220	230	0.0128	72	69
	1455	132S	89.2	89.4	88.2	83.0	77.0	68.0	10.6	780	36.1	230	230	0.0285	63	70
	970	132M	87.4	87.7	86.2	77.0	66.0	55.0	12.0	710	54.2	210	210	0.0494	61	87
	715	160M	85.8	88.4	87.8	74.0	70.0	58.0	11.9	600	73.3	200	200	0.0989	60	113
7.5	2920	132S	89.5	90.1	89.2	88.0	86.0	80.0	13.4	770	24.6	220	230	0.0151	72	75
	1455	132M	90.1	90.4	89.4	84.0	78.0	68.0	14.0	740	49.2	230	230	0.0366	63	90
	970	160M	88.5	89.9	89.5	78.0	74.0	64.0	14.9	670	74.1	210	210	0.0964	65	118
	720	160L	87.2	88.6	87.9	75.0	71.0	59.0	16.0	600	99.9	200	200	0.131	60	139
10	1460	132M	90.1	91.1	90.9	84.0	77.0	66.0	18.4	740	60.3	230	230	0.0390	67	94
11	2940	160M	90.6	90.9	90.3	89.0	88.0	83.0	19.5	750	35.7	220	230	0.0489	78	120
	1470	160M	91.0	91.7	91.2	85.0	80.0	71.0	20.0	700	71.8	220	230	0.0771	67	122
	970	160L	89.8	90.5	89.9	79.0	71.0	60.0	21.8	690	108	200	210	0.127	65	140
	730	180L	88.8	89.0	88.6	76.0	72.0	62.0	22.5	660	144	200	200	0.214	62	184
15	2940	160M	91.3	91.6	90.9	89.0	88.0	84.0	26.8	750	48.8	220	230	0.0559	78	128
	1470	160L	91.8	92.1	91.8	85.0	80.0	72.0	26.5	700	97.6	220	230	0.101	67	146
	980	180L	90.7	90.4	88.8	81.0	79.0	70.0	27.6	720	146	200	210	0.201	65	185
	730	200L	90.0	90.3	89.5	76.0	74.0	63.0	30.3	660	197	200	200	0.401	65	260
18.5	2940	160L	91.8	91.6	91.0	89.0	89.0	84.0	32.6	750	60.1	220	230	0.0648	78	142
	1470	180M	92.2	92.0	91.6	86.0	85.0	77.0	32.5	750	120	220	230	0.152	68	179
	985	200L	91.3	91.1	90.6	81.0	78.0	72.0	34.8	720	180	210	210	0.325	68	242
	735	225S	90.7	90.7	89.8	76.0	69.0	57.0	37.7	660	241	190	200	0.529	65	275

- Notes:
1. Output at 415V also suitable for 380V and 400V operation. For 380V multiply full load current by 1.092. For 400V multiply full load current by 1.0375.
 2. Test Method : AS1359 , Table 2 , Method B.
 3. Tolerance : AS60034.1
 4. dB(A): Mean Sound Pressure Level at no load and 1 metre.

TYPICAL PERFORMANCE DATA



CAST IRON TEFC 3 - PHASE SQUIRREL CAGE INDUCTION MOTORS
MONARCH GX RANGE 80 - 400L FRAME (415V 50Hz)

OUT PUT kW	FULL LOAD RPM	FRAME NO.	EFFICIENCY			POWER FACTOR			CURRENT		TORQUE			INERTIA	dB(A)	WEIGHT foot mount (kg)
			FULL LOAD (%)	3/4 LOAD (%)	1/2 LOAD (%)	FULL LOAD (%)	3/4 LOAD (%)	1/2 LOAD (%)	FULL LOAD (A)	LOCKED ROTOR (%)	FULL LOAD Nm	LOCKED ROTOR %FLT	BREAK DOWN %FLT	ROTOR J = GD2/4 kg-m2		
22	2945	180M	92.2	92.0	91.0	90.0	89.0	84.0	36.2	750	71.6	220	230	0.0808	81	176
	1470	180L	92.6	92.6	91.8	86.0	85.0	77.0	37.8	780	143	220	230	0.187	68	206
	980	200L	91.8	91.9	91.3	83.0	80.0	74.0	40.2	750	214	210	210	0.371	68	258
	735	225M	91.2	91.6	90.7	78.0	72.0	61.0	43.3	660	287	190	200	0.626	65	309
30	2955	200L	92.9	92.6	91.8	90.0	90.0	86.0	49.0	750	96.9	200	230	0.163	84	250
	1475	200L	93.2	93.5	93.0	86.0	84.0	78.0	52.8	720	195	220	230	0.285	71	255
	985	225M	92.5	92.9	92.2	84.0	81.0	73.0	52.4	710	291	210	210	0.533	68	303
	740	250M	92.1	91.8	90.7	79.0	71.0	60.0	59.3	660	388	190	200	0.914	67	401
37	2955	200L	93.3	93.0	92.3	90.0	89.0	85.0	60.6	750	120	200	230	0.172	84	258
	1480	225S	93.6	93.8	93.2	87.0	84.0	79.0	64.2	740	239	200	230	0.473	73	305
	985	250M	93.0	92.7	91.8	85.0	83.0	75.0	64.0	700	358	210	210	0.877	70	395
	741	280S	92.7	92.6	91.3	78.0	74.0	64.0	69.0	660	477	190	200	1.85	68	567
45	2970	225M	93.7	93.8	93.2	90.0	89.0	86.0	72.7	750	145	200	230	0.302	84	336
	1480	225M	93.9	93.9	93.6	87.0	85.0	80.0	78.1	740	290	220	230	0.554	73	342
	991	280S	93.5	93.7	92.6	86.0	83.0	75.0	77.0	700	434	210	200	1.85	72	567
	742	280M	93.2	93.6	92.5	79.0	76.0	66.0	84.0	660	579	190	200	2.22	68	651
55	2975	250M	94.0	94.1	93.7	90.0	90.0	86.0	89.5	750	177	200	230	0.420	85	434
	1480	250M	94.2	94.2	93.5	87.0	87.0	81.0	91.6	740	356	200	220	0.751	75	428
	990	280M	93.9	94.4	93.5	87.0	84.0	80.0	94.0	700	531	210	200	2.12	72	625
	741	315S	93.7	93.6	92.4	78.0	73.0	62.0	101	660	710	180	210	2.97	74	1000
75	2979	280SA	94.6	94.4	92.6	90.0	89.0	84.0	121	750	241	200	230	0.986	86	616
	1485	250M***	94.7	94.5	93.4	88.0	88.0	83.0	127	740	483	220	230	0.824	78	515
	1487	280S	94.7	95.2	94.4	87.0	84.0	76.0	127	720	482	220	230	1.92	78	657
	989	315S	94.4	94.1	93.3	85.0	80.0	73.0	128	700	729	200	200	2.61	77	990
	741	315M	94.4	94.2	93.3	79.0	75.0	65.0	136	660	967	180	200	3.96	74	1100
90	2978	280M	94.8	94.5	92.8	91.0	90.0	88.0	145	750	289	200	230	1.04	86	660
	1486	280M	95.0	95.2	94.4	87.0	84.0	77.0	151	720	579	220	230	2.32	78	748
	988	315M	94.8	94.9	94.5	86.0	83.0	76.0	153	700	872	200	200	3.04	77	1080
	741	315L	94.7	94.6	93.8	81.0	77.0	68.0	161	660	1161	180	200	4.65	74	1160
110	2980	280M***	95.1	95.4	94.9	92.0	91.0	90.0	177	710	353	180	220	1.30	86	755
	2975	315S	95.1	94.8	93.1	92.0	91.0	89.0	177	710	353	180	220	1.33	88	980
	1486	280M***	95.3	95.3	94.6	88.0	86.0	79.0	185	720	708	220	230	2.47	85	780
	1489	315S	95.3	95.2	94.3	89.0	89.0	84.0	182	690	706	210	220	2.34	85	1000
	989	315L	95.1	95.1	94.4	86.0	83.0	76.0	187	670	1062	200	200	3.71	77	1150
	741	315L	95.1	94.8	94.1	81.0	79.0	72.0	196	660	1422	180	200	5.40	74	1230
132	2978	315M	95.4	95.2	94.1	91.0	89.0	84.0	211	710	423	180	220	1.50	88	1080
	1488	315M	95.5	95.5	94.7	89.0	88.0	84.0	219	690	847	210	220	2.58	85	1100
	988	315L	95.4	95.8	95.0	87.0	85.0	79.0	223	670	1275	200	200	4.24	77	1210
	742	355M	95.4	95.5	94.7	82.0	78.0	67.0	235	640	1700	180	200	8.36	82	1700
160	2978	315L	95.5	95.2	94.3	90.0	89.0	84.0	256	710	513	180	220	1.67	91	1160
	1488	315L	95.7	95.9	95.1	90.0	88.0	80.0	261	690	1028	210	220	2.96	89	1160
	991	355M	95.6	95.7	95.4	87.0	86.0	80.0	265	670	1544	190	200	7.44	84	1650
	742	355M	95.7	95.6	95.1	82.0	79.0	72.0	284	640	2061	180	200	9.59	82	1750
200	2978	315L	95.6	95.7	95.2	91.0	90.0	84.0	320	710	641	180	220	1.88	87	1190
	1487	315L	95.5	95.6	95.0	89.0	88.0	84.0	328	690	1284	200	220	3.46	89	1270
	990	355M	95.6	95.7	95.2	88.0	87.0	82.0	331	670	1929	190	200	9.10	84	1750
	741	355L	95.7	95.8	95.3	82.0	81.0	75.0	355	640	2570	180	200	11.30	73	1850

- Notes:**
1. Output at 415V also suitable for 380V and 400V operation. For 380V multiply full load current by 1.092. For 400V multiply full load current by 1.0375.
 2. Test Method: AS1359, Table 2, Method B.
 3. Tolerance: AS60034.1
 4. Mean Sound Pressure Level at no load and 1 metre.
 5. Frame sizes to AS1359.30 1997 Western European allocations from CENELEC HD231 apart from motors with suffix*** which are to AS1359.30 1997 Australia British allocations.

TYPICAL PERFORMANCE DATA



CAST IRON TEFC 3 - PHASE SQUIRREL CAGE INDUCTION MOTORS
MONARCH GX RANGE 80 - 400L FRAME (415V 50Hz)

OUTPUT kW	FULL LOAD RPM	FRAME NO.	EFFICIENCY			POWER FACTOR			CURRENT		TORQUE			INERTIA ROTOR J = GD2/4 kg-m2	dB(A)	WEIGHT foot mount (kg)
			FULL LOAD (%)	3/4 LOAD (%)	1/2 LOAD (%)	FULL LOAD (%)	3/4 LOAD (%)	1/2 LOAD (%)	FULL LOAD (A)	LOCKED ROTOR (%)	FULL LOAD Nm	LOCKED ROTOR %FLT	BREAK DOWN %FLT			
250	2978	355M	95.6	95.7	95.0	90.0	89.0	89.0	394	710	801	160	220	4.02	91	1760
	1490	355M	95.8	95.9	95.1	90.0	89.0	89.0	403	690	1603	210	220	6.60	85	1830
	990	355L	95.6	95.7	95.0	88.0	87.0	81.0	413	670	2412	190	220	10.80	75	1850
	743	400L	95.7	95.8	95.1	80.0	79.0	73.0	454	650	3213	160	220	19.10	75	2770
315	2978	355L	96.4	96.3	95.6	92.0	91.0	85.0	494	710	1010	160	220	4.86	91	1850
	1490	355L	96.4	96.3	95.6	90.0	89.0	83.0	506	690	2019	210	220	7.55	85	1850
	992	400L	96.1	96.0	95.3	86.0	85.0	79.0	530	650	3032	160	220	18.50	79	2764
	743	400L	95.8	95.7	95.0	80.0	78.0	73.0	572	650	4049	160	220	23.00	75	2980
355	1489	400L	96.4	96.3	95.6	87.0	86.0	80.0	589	690	2277	160	220	13.30	85	2800
	993	400L	96.3	96.2	95.5	86.0	85.0	79.0	672	650	3414	160	220	20.70	80	2910
	742	400L	95.8	95.7	95.2	80.0	78.0	72.0	645	650	4569	160	220	25.20	75	3120
	400	400L	96.4	96.3	95.6	87.0	86.0	80.0	663	690	2565	160	220	14.10	85	2890
400	993	400L	96.3	96.2	95.5	86.0	85.0	79.0	672	650	3847	160	220	22.30	81	3030
	450	400L	96.5	96.4	95.7	87.0	86.0	80.0	746	690	2886	160	220	15.30	85	2980
450	992	400L	96.4	96.3	95.6	86.0	85.0	79.0	755	650	4332	160	220	22.30	81	3030
	500	400L	96.6	96.5	95.8	88.0	87.0	81.0	818	690	3207	160	220	17.10	85	3080

TWO SPEED PERFORMANCE DATA

TWO SPEED (415V 50Hz)			HIGH SPEED, FULL LOAD				LOW SPEED, FULL LOAD				WEIGHT foot mount (kg)
OUTPUT kW HIGH SPEED	OUTPUT kW LOW SPEED	FRAME NO.	RPM	EFFICIENCY %	POWER FACTOR %	CURRENT (A)	RPM	EFFICIENCY %	POWER FACTOR %	CURRENT (A)	
2 Pole 4 Pole (Tapped Wound)											
0.8	0.16	D80	2745	71.4%	89.5%	1.83	1425	71.0%	72.2%	0.43	17
1.2	0.24	D90S	2825	72.3%	88.6%	2.66	1430	75.2%	76.7%	0.58	22
1.7	0.34	D90L	2840	75.1%	89.5%	3.66	1430	78.9%	77.2%	0.84	25
2.4	0.48	D100L	2850	76.2%	91.5%	4.97	1450	79.1%	77.3%	1.07	33
3.3	0.66	D112M	2805	82.9%	92.9%	6.19	1465	82.6%	81.5%	1.42	43
4.4	0.88	D132S	2895	81.7%	89.9%	8.83	1475	85.5%	80.8%	1.83	64
6.1	1.2	D132S	2875	83.3%	91.5%	12.0	1470	86.8%	83.4%	2.38	70
8.3	1.7	D160M	2920	86.9%	90.0%	14.4	1475	84.5%	80.0%	3.40	117
12	2.4	D160L	2935	88.2%	93.0%	21.3	1480	86.7%	82.8%	4.80	147
4 Pole 8 Pole (Tapped Wound)											
0.6	0.12	D80	1405	71.1%	71.0%	1.65	655	43.4%	52.0%	0.74	17
0.8	0.16	D90S	1405	74.5%	85.0%	1.76	680	55.3%	60.0%	0.67	22
1.2	0.24	D90L	1415	77.4%	81.0%	2.66	690	60.1%	55.0%	1.01	27
1.7	0.34	D100L	1420	79.2%	86.4%	3.43	705	63.7%	60.1%	1.07	34
2.4	0.48	D100L	1410	80.6%	86.0%	4.78	710	60.4%	52.0%	2.14	38
3.3	0.66	D112M	1420	79.4%	84.8%	6.72	710	75.9%	62.0%	1.99	43
4.4	0.88	D132S	1455	81.1%	78.4%	9.54	730	77.2%	54.4%	2.83	68
6.1	1.2	D132M	1460	84.8%	85.9%	12.2	730	80.2%	59.5%	3.72	81
8.3	1.7	D160M	1450	86.5%	88.6%	15.0	730	85.1%	65.0%	4.40	123
12	2.4	D160L	1450	87.8%	91.9%	21.3	730	86.8%	74.0%	5.90	144
17	3.4	D180L	1470	89.9%	87.2%	30.1	735	86.7%	67.1%	8.10	190
4 Pole 6 Pole (Dual Wound)											
0.55	0.18	D80	1405	66.8%	68.0%	1.67	930	45.9%	45.0%	1.20	17
0.75	0.25	D90S	1425	65.4%	76.6%	1.84	950	59.5%	56.0%	0.85	22
1.1	0.36	D90L	1425	69.8%	80.4%	2.56	940	63.8%	67.0%	1.20	27
1.5	0.6	D100L	1445	78.2%	76.4%	3.39	950	69.0%	63.1%	1.85	34
2.2	0.75	D100L	1430	80.7%	81.9%	4.54	955	65.3%	59.1%	2.65	38
3	1	D112M	1455	83.1%	74.5%	6.60	965	73.3%	65.2%	2.94	43
4	1.3	D132S	1460	85.5%	81.5%	8.14	970	77.6%	66.9%	3.80	68
5.5	1.8	D132M	1465	86.9%	78.5%	11.5	975	79.3%	65.4%	5.08	81
7.5	2.5	D160M	1465	88.8%	83.1%	14.2	980	84.8%	66.0%	6.4	123
11	3.5	D160L	1460	88.8%	85.3%	20.2	980	84.7%	66.0%	8.7	144
15	5	D180M	1465	88.7%	92.7%	26.0	985	83.6%	80.8%	10.6	182
6 Pole 8 Pole (Dual Wound)											
0.55	0.24	D90S	960	67.4%	63.0%	1.80	710	52.9%	55.0%	1.14	23
0.75	0.32	D90L	950	68.9%	70.0%	2.16	705	53.6%	53.0%	1.55	25
1.1	0.47	D100L	960	72.3%	63.0%	3.35	710	60.0%	54.0%	2.02	33
1.5	0.55	D112M	955	77.5%	75.4%	3.70	710	75.9%	62.0%	2.04	45
2.2	0.95	D132S	970	77.1%	72.5%	5.18	725	75.7%	62.8%	2.85	63
3	1.3	D132M	970	82.2%	73.7%	6.62	720	78.6%	70.4%	3.59	73
4	1.7	D132M	970	82.6%	78.3%	8.78	725	75.9%	68.1%	4.84	84
5.5	2.4	D160M	970	84.3%	81.1%	11.0	730	79.4%	63.0%	6.60	119
7.5	3.2	D160L	970	85.8%	83.8%	16.0	730	81.3%	68.2%	8.00	147
11	4.7	D180L	980	87.6%	80.9%	21.8	735	83.3%	75.9%	11.2	195
13	5.5	D200L	980	89.1%	85.1%	24.0	735	81.5%	69.6%	13.4	220
15	6.5	D200L	980	89.6%	83.7%	28.0	735	82.2%	70.7%	15.6	250

OUTLINE DIMENSIONS SHEET

MONARCH

MONARCH GX CAST IRON 3 - PHASE SQUIRREL CAGE INDUCTION MOTORS FRAME 80 - 400 FOOT MOUNT

TOTALLY ENCLOSED FAN COOLED SQUIRREL CAGE ROTOR

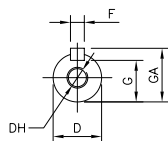

SHAFT DETAIL

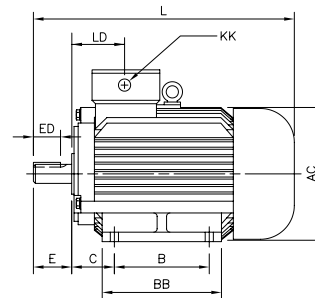
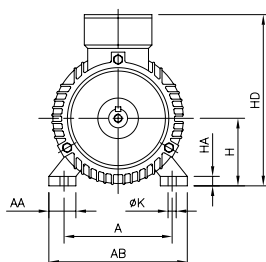

OUTPUT kW				FRAME SIZE	A	AA	AB	AC	B	BB	C	H	HA	HD
2P	4P	6P	8P											
0.75/1.1	0.55/0.75	0.55	-	80	125	34	160	160	100	130	50	80	10	235
1.5	1.1	0.75	-	90S	140	36	180	175	100	130	56	90	12	255
2.2	1.5	1.1	-	90L	140	36	180	175	125	210	56	90	12	255
3	2.2/3	1.5	0.75/1.1	100L	160	40	200	200	140	235	63	100	14	270
4	4	2.2	1.5	112M	190	45	230	220	140	250	70	112	15	300
5.5/7.5	5.5	3	2.2	132S	216	55	270	275	140	230	89	132	18	345
-	7.5	4/5.5	3	132M	216	55	270	275	178	270	89	132	18	345
11/15	11	7.5	4/5.5	160M	254	65	320	314	210	250	108	160	20	420
18.5	15	11	7.5	160L	254	65	320	314	254	294	108	160	20	420
22	18.5	-	-	180M	279	70	355	348	241	311	121	180	22	455
-	22	15	11	180L	279	70	355	348	279	349	121	180	22	455
30/37	30	18.5/22	15	200L	318	70	395	386	305	369	133	200	25	505
-	37	-	18.5	225S	356	75	435	432	286	368	149	225	28	560
45	-	-	-	225M	356	75	435	432	311	393	149	225	28	560
-	45	30	22	225M	356	75	435	432	311	393	149	225	28	560
55	-	-	-	250M	406	80	490	472	349	445	168	250	30	615
-	55	37	30	250M	406	80	490	472	349	445	168	250	30	615
-	75*	-	-	250M	406	80	490	472	349	445	168	250	30	615
75	-	-	-	280S	457	85	550	534	368	530	190	280	35	700
-	75	45	37	280S	457	85	550	534	368	530	190	280	35	700
90/110**	-	-	-	280M	457	85	550	534	419	581	190	280	35	700
-	90	55	45	280M	457	85	550	534	419	581	190	280	35	700
-	110**	-	-	280M	457	85	550	534	419	581	190	280	35	700
110	-	-	-	315S	508	120	635	620	406	616	216	315	45	815
-	110	75	55	315S	508	120	635	620	406	616	216	315	45	815
132	-	-	-	315M	508	120	635	620	457	676	216	315	45	815
-	132	90	75	315M	508	120	635	620	457	676	216	315	45	815
160/200	-	-	-	315L	508	120	635	620	508	726	216	315	45	815
-	160/200	110/132	90/110	315L	508	120	635	620	508	726	216	315	45	815
250	-	-	-	355M	610	116	730	710	560	820	254	355	52	1010
-	250[D]	160/200	132/160	355M	610	116	730	710	560	820	254	355	52	1010
-	250[B]	-	-	355M	610	116	730	710	560	820	254	355	52	1010
315	-	-	-	355L	610	116	730	710	630	820	254	355	52	1010
-	315[D]	250	200	355L	610	116	730	710	630	820	254	355	52	1010
-	315[B]	-	-	355L	610	116	730	710	630	820	254	355	52	1010
-	355/400	315/355	250/315	400L***	686	150	840	810	710	1075	280	400	55	1160
-	450/500	400/450	355											

FRAME SIZE	SHAFT EXTENSION												BEARINGS	
	K	KK	L	LD	D	E	ED	F	G	GA	DH	DE	NDE	
80	10	M25x1.5	300	75	19	40	22	6	15.5	21.5	M6x12	6204ZZ	6204ZZ	
90S	10	M25x1.5	355	75	24	50	32	8	20	27	M8x16	6205ZZ	6205ZZ	
90L	10	M25x1.5	385	75	24	50	32	8	20	27	M8x16	6205ZZ	6205ZZ	
100L	12	M32x1.5	430	83	28	60	40	8	24	31	M10x20	6206ZZ	6206ZZ	
112M	12	M32x1.5	465	87	28	60	40	8	24	31	M10x20	6206ZZ	6206ZZ	
132S	12	M32x1.5	510	102	38	80	56	10	33	41	M12x24	6208ZZ	6208ZZ	
132M	12	M32x1.5	550	102	38	80	56	10	33	41	M12x24	6208ZZ	6208ZZ	
160M	15	M40x1.5	615	142	42	110	80	12	37	45	M16x32	6309ZZ(6209ZZ)	6209ZZ	
160L	15	M40x1.5	670	142	42	110	80	12	37	45	M16x32	6309ZZ(6209ZZ)	6209ZZ	
180M	15	M40x1.5	700	164	48	110	80	14	42.5	51.5	M16x32	6311(6211)	6211	
180L	15	M40x1.5	740	164	48	110	80	14	42.5	51.5	M16x32	6311(6211)	6211	
200L	19	M50x1.5	770	191	55	110	80	16	49	59	M20x40	6312(6212)	6212	
225S(4-8)	19	M50x1.5	815	191	60	140	100	18	53	64	M20x40	6313	6312	
225M(2)	19	M50x1.5	820	197	55	110	80	16	49	59	M20x40	6312	6312	
225M(4-8)	19	M50x1.5	845	197	60	140	100	18	53	64	M20x40	6313	6312	
250M(2)	24	BLANK	910	215	60	140	100	18	53	64	M20x40	6313	6313	
250M(4-8)	24	BLANK	910	215	65	140	100	18	58	69	M20x40	NU314	6313	
250M(75kW)	24	BLANK	910	215	70	140	110	20	62.5	74.5	M20x40	NU315	6313	
280S(2)	24	BLANK	1000	221	65	140	100	18	58	69	M20x40	6314	6314	
280S(4-8)	24	BLANK	1000	221	75	140	100	20	67.5	79.5	M20x40	NU317	6314	
280M(2)	24	BLANK	1050	221	65	140	100	18	58	69	M20x40	6314	6314	
280M(4-8)	24	BLANK	1050	221	75	140	100	20	67.5	79.5	M20x40	NU317	6314	
280M(110kW)	24	BLANK	1050	221	80	170	140	22	71	85	M20x40	NU317	6314	
315S(2)	28	BLANK	1178	257	65	140	100	18	58	69	M20x40	6317	6317	
315S(4-8)	28	BLANK	1208	257	80	170	130	22	71	85	M20x40	NU319	6319	
315M(2)	28	BLANK	1238	257	65	140	100	18	58	69	M20x40	6317	6317	
315M(4-8)	28	BLANK	1268	257	80	170	130	22	71	85	M20x40	NU319	6319	
315L(2)	28	BLANK	1288	257	65	140	100	18	58	69	M20x40	6317	6317	
315L(4-8)	28	BLANK	1318	257	80	170	130	22	71	85	M20x40	NU319	6319	
355M(2)	28	BLANK	1500	284	75	140	100	20	67.5	79.5	M20x40	6319	6319	
355M(4-8)	28	BLANK	1530	284	95	170	130	25	85	99	M24x48	NU322	6322	
355M(250kW)	28	BLANK	1530	284	110	210	170	28	100	116	M24x48	NU324	6322	
355L(2)	28	BLANK	1500	284	75	140	100	20	67.5	79.5	M20x40	6319	6319	
355L(4-8)	28	BLANK	1530	284	95	170	130	25	86	100	M24x48	NU322	6322	
355L(315kW)	28	BLANK	1530	284	110	210	170	28	100	116	M24x48	NU324	6322	
400L(4-8)	35	BLANK	1910	425	100	210	170	28	90	106	M24x48	NU324	6324	

- Notes:**
1. Dimensional data subject to change without notice.
 2. Lifting facilities provided on motors frame size D100 and larger.
 3. For tolerances see page 11.
 4. Bearing numbers in brackets apply to 2 pole motors.
 5. **AS1359 Australian/British frame allocations available for 110kw 2 pole, 75kw and 110kw 4 pole.
 6. Two speed motor mandatory mounting and shaft dimensions are as per this catalogue except for 80 - 132 frame . Refer Teco for two speed motor outline drawings.
 7. D = direct drive , B = belt drive.
 8. *** = Direct drive only , refer teco for belt drive dimensions.

OUTLINE DIMENSIONS SHEET

MONARCH

MONARCH GX CAST IRON 3 - PHASE SQUIRREL CAGE INDUCTION MOTORS FRAME 80 - 280 FLANGE MOUNT TOTALLY ENCLOSED FAN COOLED SQUIRREL CAGE ROTOR

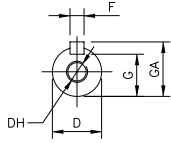

SHAFT DETAIL

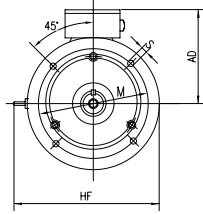

FIGURE 1

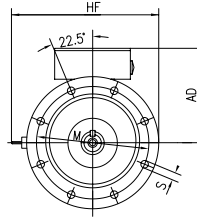
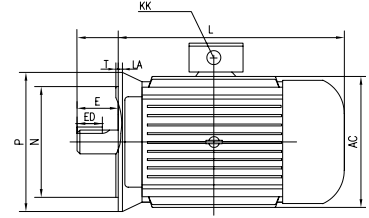

FIGURE 2



OUTPUT kW				FRAME SIZE	FIG. NO.	AC	AD	HF	L	LA	M	N	P	S	T
2P	4P	6P	8P												
0.75/1.1	0.55/0.75	0.55	-	80	1	158	155	200	300	12	165	130	200	12	3.5
1.5	1.1	0.75	-	90S	1	175	160	200	355	12	165	130	200	12	3.5
2.2	1.5	1.1	-	90L	1	175	160	200	385	12	165	130	200	12	3.5
3	2.2/3	1.5	0.75/1.1	100L	1	197	180	270	430	13	215	180	250	15	4
4	4	2.2	1.5	112M	1	220	190	275	465	14	215	180	250	15	4
5.5/7.5	5.5	3	2.2	132S	1	262	210	330	510	14	265	230	300	15	4
-	7.5	4/5.5	3	132M	1	262	210	330	550	14	265	230	300	15	4
11/15	11	7.5	4/5.5	160M	1	314	255	385	615	15	300	250	350	19	5
18.5	15	11	7.5	160L	1	314	255	385	670	15	300	250	350	19	5
22	18.5	-	-	180M	1	348	280	430	700	15	300	250	350	19	5
-	22	15	11	180L	1	348	280	430	740	15	300	250	350	19	5
30/37	30	18.5/22	15	200L	1	386	305	480	770	17	350	300	400	19	5
-	37	-	18.5	225S	2	432	335	535	815	20	400	350	450	19	5
45	-	-	-	225M	2	432	335	535	820	20	400	350	450	19	5
-	45	30	22	225M	2	432	335	535	845	20	400	350	450	19	5
55	-	-	-	250M	2	472	370	595	910	22	500	450	550	19	5
-	55	37	30	250M	2	472	370	595	910	22	500	450	550	19	5
75	-	-	-	280S	2	534	410	680	1000	22	500	450	550	19	5
-	75	45	37	280S	2	534	410	680	1000	22	500	450	550	19	5
90	-	-	-	280M	2	534	410	680	1050	22	500	450	550	19	5
-	90	55	45	280M	2	534	410	680	1050	22	500	450	550	19	5

FRAME SIZE	SHAFT EXTENSION									BEARINGS	
	KK	D	E	ED	F	G	GA	DH	DE	NDE	
80	M25x1.5	19	40	22	6	15.5	21.5	M6x12	6204ZZ	6204ZZ	
90S	M25x1.5	24	50	32	8	20	27	M8x16	6205ZZ	6205ZZ	
90L	M25X1.5	24	50	32	8	20	27	M8x16	6205ZZ	6205ZZ	
100L	M32x1.5	28	60	40	8	24	31	M10x20	6206ZZ	6206ZZ	
112M	M32x1.5	28	60	40	8	24	31	M10x20	6206ZZ	6206ZZ	
132S	M32x1.5	38	80	56	10	33	41	M12x24	6208ZZ	6208ZZ	
132M	M32x1.5	38	80	56	10	33	41	M12x24	6208ZZ	6208ZZ	
160M	M40x1.5	42	110	80	12	37	45	M16x32	6309ZZ(6209ZZ)	6209ZZ	
160L	M40x1.5	42	110	80	12	37	45	M16x32	6309ZZ(6209ZZ)	6209ZZ	
180M	M40x1.5	48	110	80	14	42.5	51.5	M16x32	6311(6211)	6211	
180L	M40x1.5	48	110	80	14	42.5	51.5	M16x32	6311(6211)	6211	
200L	M50x1.5	55	110	80	16	49	59	M20x40	6312(6212)	6212	
225S(4-8)	M50x1.5	60	140	100	18	53	64	M20x40	6313	6312	
225M(2)	M50x1.5	55	110	80	16	49	59	M20x40	6312	6312	
225M(4-8)	M50x1.5	60	140	100	18	53	64	M20x40	6313	6312	
250M(2)	BLANK	60	140	100	18	53	64	M20x40	6313	6313	
250M(4-8)	BLANK	65	140	100	18	58	69	M20x40	NU314	6313	
280S(2)	BLANK	65	140	100	18	58	69	M20x40	6314	6314	
280S(4-8)	BLANK	75	140	100	20	67.5	79.5	M20x40	NU317	6314	
280M(2)	BLANK	65	140	100	18	58	69	M20x40	6314	6314	
280M(4-8)	BLANK	75	140	100	20	67.5	79.5	M20x40	NU317	6314	

MONARCH GX CAST IRON 3 - PHASE SQUIRREL CAGE INDUCTION MOTORS FRAME 80 - 250 FOOT MOUNT TOTALLY ENCLOSED AIR OVER MOTOR IC418 (AIRSTREAM RATED)

OUTPUT kW				FRAME SIZE	E	L	LD
2P	4P	6P	8P				
0.75/1.1	0.55/0.75	0.55	-	80	40	248	76
1.5	1.1	0.75	-	90S	50	300	75
2.2	1.5	1.1	-	90L	50	330	75
3	2.2/3	1.5	0.75/1.1	100L	60	380	83
4	4	2.2	1.5	112M	60	410	87
5.5/7.5	5.5	3	2.2	132S	80	430	102
-	7.5	4/5.5	3	132M	80	470	102
11/15	11	7.5	4/5.5	160M	110	522	142
18.5	15	11	7.5	160L	110	566	142
22	18.5	-	-	180M	110	587	164
-	22	15	11	180L	110	625	164
30/37	30	18.5/22	15	200L	110	660	191
-	37	-	18.5	225S	140	703	197
45	-	-	-	225M	110	698	197
-	45	30	22	225M	140	728	197
55	-	-	-	250M	140	790	215
-	55	37	30	250M	140	790	215

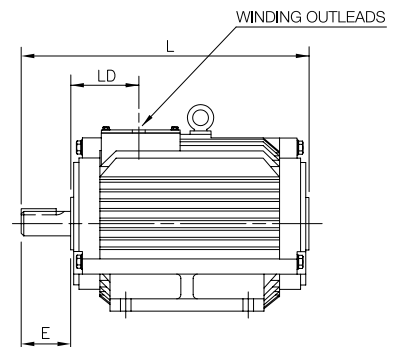

- Notes:
1. Dimensional data subject to change without notice.
 2. Lifting facilities provided on motors frame size D100 and larger.
 3. For tolerances see page 11.
 4. Bearing numbers in brackets apply to 2 pole motors.

OUTLINE DIMENSIONS SHEET

MONARCH

MONARCH GX CAST IRON 3 - PHASE SQUIRREL CAGE INDUCTION MOTORS FRAME 80 - 400L FOOT & FLANGE MOUNT
TOTALLY ENCLOSED FAN COOLED SQUIRREL CAGE ROTOR

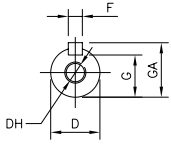

SHAFT DETAIL

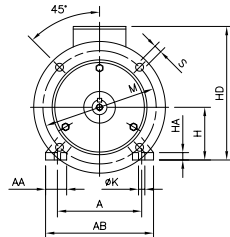

FIGURE 1

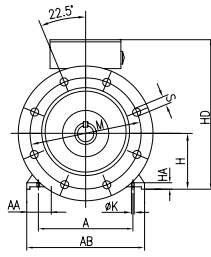
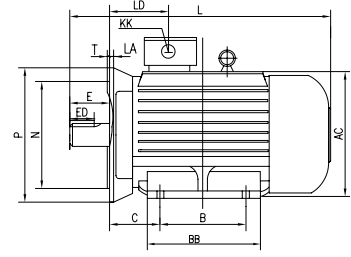

FIGURE 2



OUTPUT kW				FRAME SIZE	A	AA	AB	AC	B	BB	C	H	HA	HD	K	KK	L
2P	4P	6P	8P														
0.75/1.1	0.55/0.75	0.55	-	80	125	34	160	160	100	130	50	80	10	235	10	M25x1.5	300
1.5	1.1	0.75	-	90S	140	36	180	175	100	130	56	90	12	255	10	M25x1.5	355
2.2	1.5	1.1	-	90L	140	36	180	175	125	210	56	90	12	255	10	M25x1.5	385
3	2.2/3	1.5	0.75/1.1	100L	160	40	200	197	140	235	63	100	14	270	12	M32x1.5	430
4	4	2.2	1.5	112M	190	45	230	220	140	250	70	112	15	300	12	M32x1.5	465
5.5/7.5	5.5	3	2.2	132S	216	55	270	262	140	230	89	132	18	345	12	M32x1.5	510
-	7.5	4/5.5	3	132M	216	55	270	262	178	270	89	132	18	345	12	M32x1.5	550
11/15	11	7.5	4/5.5	160M	254	65	320	314	210	250	108	160	20	420	15	M40x1.5	615
18.5	15	11	7.5	160L	254	65	320	314	254	294	108	160	20	420	15	M40x1.5	670
22	18.5	-	-	180M	279	70	355	348	241	311	121	180	22	455	15	M40x1.5	700
-	22	15	11	180L	279	70	355	348	279	349	121	180	22	455	15	M40x1.5	740
30/37	30	18.5/22	15	200L	318	70	395	386	305	369	133	200	25	505	19	M50x1.5	770
-	37	-	18.5	225S	356	75	435	432	286	368	149	225	28	560	19	M50x1.5	815
45	-	-	-	225M	356	75	435	432	311	393	149	225	28	560	19	M50x1.5	820
-	45	30	22	225M	356	75	435	432	311	393	149	225	28	560	19	M50x1.5	845
55	-	-	-	250M	406	80	490	472	349	445	168	250	30	615	24	BLANK	910
-	55	37	30	250M	406	80	490	472	349	445	168	250	30	615	24	BLANK	910
-	75**	-	-	250M	406	80	490	472	349	445	168	250	30	615	24	BLANK	910
75	-	-	-	280S	457	85	550	534	368	530	190	280	35	700	24	BLANK	1000
-	75	45	37	280S	457	85	550	534	368	530	190	280	35	700	24	BLANK	1000
90	-	-	-	280M	457	85	550	534	419	581	190	280	35	700	24	BLANK	1050
-	90/110	55	45	280M	457	85	550	534	419	581	190	280	35	700	24	BLANK	1050
110	-	-	-	315S	508	120	635	620	406	616	216	315	45	815	28	BLANK	1178
-	110	75	45	315S	508	120	635	620	406	616	216	315	45	815	28	BLANK	1208
132	-	-	-	315M	508	120	635	620	457	676	216	315	45	815	28	BLANK	1238
-	132	90	75	315M	508	120	635	620	457	676	216	315	45	815	28	BLANK	1268
160/200	-	-	-	315L	508	120	635	620	508	726	216	315	45	815	28	BLANK	1288
-	160/200	110/132	90/110	315L	508	120	635	620	508	726	216	315	45	815	28	BLANK	1318
250	-	-	-	355M	610	116	730	710	560	820	254	355	52	1010	28	BLANK	1500
-	250[D]	160/200	132/160	355M	610	116	730	710	560	820	254	355	52	1010	28	BLANK	1530
315	-	-	-	355L	610	116	730	710	630	820	254	355	52	1010	28	BLANK	1500
-	315[D]	250	200	355L	610	116	730	710	630	820	254	355	52	1010	28	BLANK	1530
-	355/400	315/355	250/315 355	400L	686	150	840	826	710	1075	280	400	55	1160	35	BLANK	1910
-	450/500	400/450															

FRAME SIZE	SHAFT EXTENSION														BEARINGS	
	LA	LD	M	N	P	S	T	D	E	ED	F	G	GA	DH	DE	NDE
80	12	76	165	130	200	12	3.5	19	40	22	6	15.5	21.5	M6x12	6204ZZ	6204ZZ
90S	12	75	165	130	200	12	3.5	24	50	32	8	20	27	M8x16	6205ZZ	6205ZZ
90L	12	75	165	130	200	12	3.5	24	50	32	8	20	27	M8x16	6205ZZ	6205ZZ
100L	13	83	215	180	250	15	4	28	60	40	8	24	31	M10x20	6206ZZ	6206ZZ
112M	14	87	215	180	250	15	4	28	60	40	8	24	31	M10x20	6206ZZ	6206ZZ
132S	14	102	265	230	300	15	4	38	80	56	10	33	41	M12x24	6208ZZ	6208ZZ
132M	14	102	265	230	300	15	4	38	80	56	10	33	41	M12x24	6208ZZ	6208ZZ
160M	15	142	300	250	350	19	5	42	110	80	12	37	45	M16x32	6309ZZ [6209ZZ]	6209ZZ
160L	15	142	300	250	350	19	5	42	110	80	12	37	45	M16x32	6309ZZ [6209ZZ]	6209ZZ
180M	15	164	300	250	350	19	5	48	110	80	14	42.5	51.5	M16x32	6311 [6211]	6211
180L	15	164	300	250	350	19	5	48	110	80	14	42.5	51.5	M16x32	6311 [6211]	6211
200L	17	191	350	300	400	19	5	55	110	80	16	49	59	M20x40	6312 [6212]	6212
225S(4-8)	20	191	400	350	450	19	5	60	140	100	18	53	64	M20x40	6313	6312
225M(2)	20	197	400	350	450	19	5	55	110	80	16	49	59	M20x40	6312	6312
225M(4-8)	20	197	400	350	450	19	5	60	140	100	18	53	64	M20x40	6313	6312
250M(2)	22	215	500	450	550	19	5	60	140	100	18	53	64	M20x40	6313	6313
250M(4-8)	22	215	500	450	550	19	5	65	140	100	18	58	69	M20x40	NU314	6313
250M(75**)	22	215	500	450	550	19	5	70	140	110	20	62.5	74.5	M20x40	NU315	6313
280S(2)	22	221	500	450	550	19	5	65	140	100	18	58	69	M20x40	6314	6314
280S(4-8)	22	221	500	450	550	19	5	75	140	100	18	67.5	79.5	M20x40	NU317	6314
280M(2)	22	221	500	450	550	19	5	65	140	100	18	53	69	M20x40	6314	6314
280M(4-8)	22	221	500	450	550	19	5	75	140	100	20	67.5	79.5	M20x40	NU317	6314
280M(110**)	22	221	500	450	550	19	5	80	170	140	22	71	85	M20x40	NU317	6314
315S(2)	22	257	600	550	660	24	6	65	140	100	18	58	69	M20x40	6317	6317
315S(4-8)	22	257	600	550	660	24	6	80	170	100	22	71	85	M20x40	NU319	6319
315M(2)	22	257	600	550	660	24	6	65	140	100	18	58	69	M20x40	6317	6317
315M(4-8)	22	257	600	550	660	24	6	80	170	100	22	71	85	M20x40	NU319	6319
315L(2)	22	257	600	550	660	24	6	65	140	100	18	58	69	M20x40	6317	6317
315L(4-8)	22	257	600	550	660	24	6	80	170	100	22	71	85	M20x40	NU319	6319
355M(2)	25	284	740	680	800	24	6	75	140	100	20	67.5	79.5	M20x40	6319	6319
355M(4-8)	25	284	740	680	800	24	6	95	170	130	25	85	99	M20x40	NU322	6322
355L(2)	25	284	740	680	800	24	6	75	140	100	20	67.5	79.5	M20x40	6319	6319
355L(4-8)	25	284	740	680	800	24	6	95	170	130	25	86	100	M20x40	NU322	6322
400L(4-8)	32	425	940	880	1000	28	6	110	210	130	28	90	106	M20x40	NU324	6324

- Notes:
1. Dimensional data subject to change without notice.
 2. Lifting facilities provided on motors frame size D100 and larger.
 3. For tolerances see page 11.
 4. Bearing numbers in brackets apply to 2 pole motors.
 5. **AS1359 Australian/British frame allocations available for 110kw 2 pole, 75kw and 110kw 4 pole.

OUTLINE DIMENSIONS SHEET

MONARCH GX CAST IRON 3 - PHASE SQUIRREL CAGE INDUCTION MOTORS FRAME 80 - 132 FOOT AND C FACE TOTALLY ENCLOSED FAN COOLED SQUIRREL CAGE ROTOR

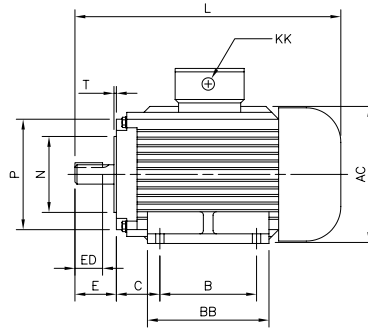
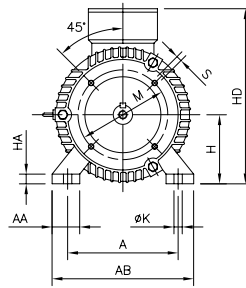
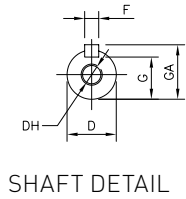

OUTPUT kW				FRAME SIZE	A	AA	AB	AC	B	BB	C	H	HA	HD	K	KK	L
2P	4P	6P	8P														
0.75/1.1	0.55/0.75	0.55	-	80	125	34	160	160	100	130	50	80	10	235	10	M25x1.5	300
1.5	1.1	0.75	-	90S	140	36	180	175	100	130	56	90	12	255	10	M25x1.5	355
2.2	1.5	1.1	-	90L	140	36	180	175	125	210	56	90	12	255	10	M25x1.5	385
3	2.2/3	1.5	0.75/1.1	100L	160	40	200	200	140	235	63	100	14	270	12	M32x1.5	430
4	4	2.2	1.5	112M	190	45	230	200	140	250	70	112	15	300	12	M32x1.5	465
5.5/7.5	5.5	3	2.2	132S	216	55	270	275	140	230	89	132	18	345	12	M32x1.5	510
-	7.5	4/5.5	3	132M	216	55	270	275	178	270	89	132	18	345	12	M32x1.5	550

FRAME SIZE	SHAFT EXTENSION											BEARINGS		
	M	N	P	S	T	D	E	ED	F	G	GA	DH	DE	NDE
80	100	80	142	M6	3.0	19	40	22	6	15.5	21.5	M6x12	6204ZZ	6204ZZ
90S	115	95	148	M8	3.0	24	50	32	8	20	27	M8x16	6205ZZ	6205ZZ
90L	115	95	148	M8	3.0	24	50	32	8	20	27	M8x16	6205ZZ	6205ZZ
100L	130	110	177	M8	3.5	28	60	40	8	24	31	M10x20	6206ZZ	6206ZZ
112M	130	110	190	M8	3.5	28	60	40	8	24	31	M10x20	6206ZZ	6206ZZ
132S	165	130	200	M10	3.5	38	80	56	10	33	41	M12x24	6208ZZ	6208ZZ
132M	165	130	200	M10	3.5	38	80	56	10	33	41	M12x24	6208ZZ	6208ZZ

MONARCH GX CAST IRON SLIDE RAILS

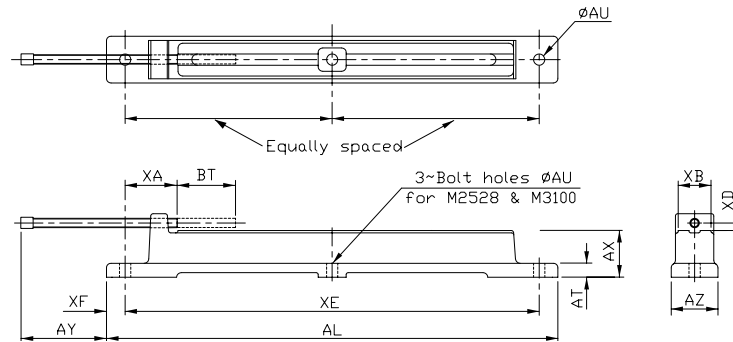

SLIDE RAIL	FRAME SIZE	AL	AT	AU	AX	AY	AZ	BT min.	XA max.	XB	XD	XE	XF
M0809	80	355	12	10	30	105	35	95	45	30	6	325	15
	90	355	12	10	30	105	35	80	45	30	6	325	15
M1013	100	470	16	12	44	170	52	160	50	43	6	430	18
	112	470	16	12	44	170	52	125	50	43	6	430	18
	132	470	16	12	44	170	52	100	50	43	6	430	18
M1618	160	615	19	15	64	170	76	155	67	57	11	565	25
	180	615	19	15	64	170	76	125	67	57	11	565	25
M2022	200	780	25	19	82	210	100	190	80	82	12	725	27
	225	780	25	19	82	210	100	140	80	82	12	725	27
M2528	250	965	30	24	100	275	100	250	86	82	16	885	40
	280	965	30	24	100	275	100	190	86	82	16	885	40
M3100	315	1215	40	38	125	380	123	330	110	95	20	1115	50

TOLERANCES

D	F	G & H	K	N	S	T
19 ≤ D ≤ 28	+0.009 -0.004	F=6	+0, -0.03	G=15.5 -0.10	K=10	+0.360 +0
38 ≤ D ≤ 48	+0.018 +0.002	8 ≤ F ≤ 10	+0, -0.036	20 ≤ G ≤ 90 -0.20	12 ≤ K ≤ 15	+0.430 +0
55 ≤ D ≤ 80	+0.030 +0.011	12 ≤ F ≤ 18	+0, -0.043	80 ≤ H ≤ 250 -0.5	19 ≤ K ≤ 28	+0.520 +0
95 ≤ D ≤ 100	+0.035 +0.013	20 ≤ F ≤ 28	+0, -0.052	280 ≤ H ≤ 400 -1.0	K=35	+0.620 +0

- Notes: 1. Dimensional data subject to change without notice.
2. Lifting facilities provided on motors frame size D100 and larger.

Motors



Drives

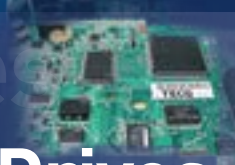

Controls



Some other products available from TECO Australia, Electric Motor Division -

Brake Motors, Crane Motors, Cooling Tower Motors, Eddy Current Motors, Hazardous Area Motors, High Efficiency Motors, High Voltage Motors, Induction Generators, Invicta Vibrator Motors, Mill use Induction Motors, Multi-speed Motors, Slip Ring Motors, Smoke Spill Motors, Synchronous Motors, Single Phase Motors, Special Application Motors, Vertical Hollow Shaft Motors, Variable Speed Drives, AC-DC Motor Controls

TECO

AUSTRALIA & NEW ZEALAND



Head Office, Sydney

TECO Australia Pty Ltd
335-337 Woodpark Road,
Smithfield NSW 2164
Tel: 02 9765 8118
Fax: 02 9604 9330



Melbourne

TECO Australia Pty Ltd
16 Longstaff Road,
Bayswater VIC 3153
Tel: 03 9720 4411
Fax: 03 9720 5355



Brisbane

TECO Australia Pty Ltd
50 Murdoch Circuit,
Acacia Ridge QLD 4110
Tel: 07 3373 9600
Fax: 07 3373 9699



Perth

TECO Australia Pty Ltd
18 Hazelhurst Street,
Kewdale WA 6105
Tel: 08 9479 4879
Fax: 08 9478 3876



New Zealand

TECO New Zealand Ltd
Unit 3, 477 Great South Road,
Penrose, Auckland
Tel: 64 9-526 8480
Fax: 64 9-526 8484
sales@teco.co.nz

Distributed by:

www.teco.com.au emd@teco.com.au

The information in this catalogue is subject to change without notice.

MONCI-032015