

# INSTRUCTION MANUAL

# TECO INVERTER

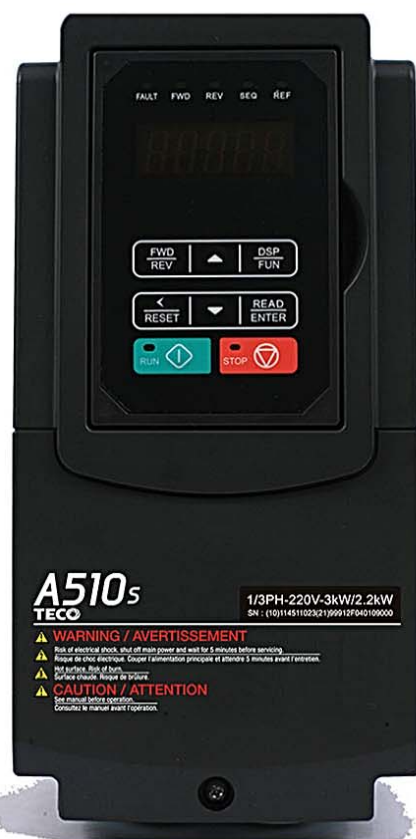

# TECO INVERTER

# A510s Series

# Table of Contents

<b>Preface</b> .....	<b>0-1</b>
<b>Chapter 1 Safety Precautions</b> .....	<b>1-1</b>
1.1 Before Supplying Power to the Inverter.....	1-1
1.2 Wiring.....	1-1
1.3 Before Operation .....	1-2
1.4 Parameters Setting.....	1-2
1.5 Operation .....	1-2
1.6 Maintenance, Inspection and Replacement .....	1-3
1.7 Disposal of the Inverter.....	1-4
1.8 Guaranteed liability exemption .....	1-4
<b>Chapter 2 Model Description</b> .....	<b>2-1</b>
2.1 Nameplate Data.....	2-1
2.2 Inverter Models – Motor Power Rating (HD-Heavy Duty) .....	2-3
<b>Chapter 3 Environment and Installation</b> .....	<b>3-1</b>
3.1 Environment.....	3-1
3.2 Installation.....	3-2
3.3 External View.....	3-3
3.4 Warning Labels.....	3-5
3.5 Removing the Front Cover and Keypad .....	3-6
3.5.1 Without Built-in filter type .....	3-6
3.5.2 Built-in filter type (400V 1 ~60HP).....	3-12
3.6 Wire Gauges and Tightening Torque .....	3-13
3.7 Wiring Peripheral Power Devices .....	3-16
3.8 General Wiring Diagram .....	3-21
3.8.1 General Wiring Diagram (For Standard H & C type) .....	3-21
3.8.2 General Wiring Diagram (For Enhanced E & G type).....	3-22
3.9 User Terminals .....	3-23
3.9.1 User (Control) Terminals (For Standard H & C type).....	3-23
3.9.2 User (Control) Terminals (For Enhanced E & G type) .....	3-26

3.10 Power Terminals.....	3-28
3.10.1 Power Terminals (For Standard H & C type).....	3-28
3.10.2 Power Terminals (For Enhanced E & G type).....	3-32
3.11 Input / Output Power Section Block Diagram.....	3-37
3.11.1 Cooling Fan Supply Voltage Selection (400V class).....	3-41
3.12 Inverter Wiring.....	3-43
3.13 Input Power and Motor Cable Length.....	3-44
3.14 Cable Length vs, Carrier Frequency.....	3-44
3.15 Installing an AC Line Reactor.....	3-44
3.16 Power Input Wire Size, NFB and MCB Part Numbers.....	3-45
3.17 Control Circuit Wiring.....	3-48
3.18 Inverter Specifications.....	3-50
3.19 Inverter Derating Based on Carrier Frequency.....	3-57
3.20 Inverter Derating Based on Temperature.....	3-60
3.21 Inverter Dimensions.....	3-62
3.22 Dimensions for Models with Built-in Filter.....	3-71
<b>Chapter 4 Keypad and Programming Functions.....</b>	<b>4-1</b>
4.1 LED Keypad.....	4-1
4.1.1 Keypad Display and Keys.....	4-1
4.1.2 Seven Segment Display Description.....	4-3
4.1.3 LED Indicator Description.....	4-5
4.1.4 Power-up Monitor.....	4-7
4.1.5 Modifying Parameters/ Set Frequency Reference.....	4-8
4.1.6 Operation Control.....	4-10
4.2 LCD Keypad.....	4-11
4.2.1 Keypad Display and Keys.....	4-11
4.2.2 Keypad Menu Structure.....	4-13
4.3 Parameters.....	4-18
4.4 Description of Parameters.....	4-95
4.5 Built-in PLC Function.....	4-374
4.5.1 Basic Command.....	4-374
4.5.2 Basic Command Function.....	4-375
4.5.3 Application Functions.....	4-376

4.6 Modbus Protocol Descriptions .....	4-381
4.6.1 Communication Connection and Data Frame.....	4-381
4.6.2 Register and Data Format.....	4-385
4.6.3 Parameter Data.....	4-394
<b>Chapter 5 Check Motor Rotation and Direction .....</b>	<b>5-1</b>
<b>Chapter 6 Speed Reference Command Configuration .....</b>	<b>6-1</b>
6.1 Reference from the Keypad.....	6-1
6.2 Reference from External Analog Signal (0-10V / 4-20mA).....	6-2
6.3 Reference from Serial Communication RS485 .....	6-4
6.4 Reference from Pulse Input.....	6-6
6.5 Reference from two Analog Inputs .....	6-7
6.6 Change Frequency Unit from Hz to rpm.....	6-7
<b>Chapter 7 Operation Method Configuration (Run / Stop).....</b>	<b>7-1</b>
7.1 Run / Stop from the LED/ LCD Keypad.....	7-1
7.2 Run / Stop from External Switch / Contact or Pushbutton.....	7-2
7.3 Run / Stop from Serial Communication RS485 .....	7-4
<b>Chapter 8 Motor and Application Specific Settings.....</b>	<b>8-1</b>
8.1 Set Motor Nameplate Data .....	8-1
8.2 Acceleration and Deceleration Time.....	8-2
8.3 Torque Compensation Gain .....	8-3
8.4 Automatic Energy Saving Functions.....	8-4
8.5 Emergency Stop .....	8-6
8.6 Forward and Reverse Jog .....	8-7
8.7 Direct / Unattended Startup .....	8-7
8.8 Analog Output Setup .....	8-8
<b>Chapter 9 Using PID Control for Constant Flow / Pressure Applications .....</b>	<b>9-1</b>

9.1 What is PID Control .....	9-1
9.2 Connect Transducer Feedback Signal .....	9-3
9.3 Engineering Units .....	9-4
9.4 Sleep / Wakeup Function .....	9-5
<b>Chapter 10 Troubleshooting and Fault Diagnostics .....</b>	<b>10-1</b>
10.1 General .....	10-1
10.2 Fault Detection Function.....	10-1
10.3 Warning / Self-diagnosis Detection Function .....	10-7
10.4 Auto-tuning Error .....	10-17
10.5 PM Motor Auto-tuning Error.....	10-18
10.6 General troubleshooting .....	10-19
10.7 Troubleshooting of the Inverter.....	10-20
10.7.1 Quick troubleshooting of the Inverter .....	10-20
10.7.2 Troubleshooting for OC, OL error displays .....	10-22
10.7.3 Troubleshooting for OV, LV error .....	10-23
10.7.4 The motor can not run.....	10-24
10.7.5 Motor Overheating .....	10-25
10.7.6 Motor runs unbalanced .....	10-26
10.8 Routine and periodic inspection .....	10-27
10.9 Maintenance .....	10-28
<b>Chapter 11 Inverter Peripheral Devices and Options .....</b>	<b>11-1</b>
11.1 Braking Resistors and Braking Units .....	11-1
11.2 AC Line Reactors.....	11-5
11.3 Input Noise Filters.....	11-8
11.4 Input Current and Fuse Specifications .....	11-11
11.5 PG Speed Feedback Card .....	11-14
11.6 Other <a href="#">Modules</a> .....	11-20
11.7 Communication Options .....	11-24
11.8 NEMA1 Kit .....	11-24
11.9 PROFIBUS high speed communication expansion card.....	11-25
11.9.1 Communication hardware and data structure .....	11-25
11.9.2 Product specifications .....	11-26

11.9.3	Installation instructions.....	11-27
11.9.4	LED indicator descriptions .....	11-29
11.9.5	Driver parameter setting descriptions .....	11-30
11.9.6	Connection instructions.....	11-30
11.9.7	Meanings of each character.....	11-31
11.9.8	PKW regional access parameters.....	11-32
11.9.9	Troubleshooting .....	11-34
11.9.10	GSD File.....	11-35
11.10	CANopen high speed communication expansion card.....	11-36
11.10.1	Communication hardware and data structure .....	11-36
11.10.2	Product specifications .....	11-37
11.10.3	Installation instructions.....	11-38
11.10.4	Transmission rate, maximum transmission distance and cable length .....	11-40
11.10.5	LED indicator descriptions .....	11-40
11.10.6	Driver parameter setting descriptions .....	11-41
11.10.7	Connection instructions.....	11-41
11.10.8	Object index list.....	11-43
11.10.9	Troubleshooting .....	11-48
11.10.10	EDS file .....	11-49
11.11	Introduction to the EtherCAT high speed communication expansion module.....	11-50
11.11.1	Communication hardware and data structure.....	11-50
11.11.2	Product specifications .....	11-51
11.11.3	Installation instructions.....	11-51
11.11.4	LED indicator descriptions .....	11-52
11.11.5	Object index list.....	11-53
11.11.6	Troubleshooting .....	11-55
11.11.7	xml file .....	11-55
11.12	I/O expansion card.....	11-56
11.12.1	Hardware and data structure .....	11-56
11.12.2	Product specifications .....	11-56
11.12.3	Installation instructions.....	11-57
11.12.4	Driver parameter setting descriptions .....	11-57
11.13	DC reactor .....	11-58
11.14	Sinusoidal output reactor .....	11-60
11.15	DC24V power expansion card.....	11-62

11.15.1 JN5-PS-DC24V product specifications .....	11-62
11.16 EtherNet/IP Communication Card (JN5-CMHI-EIP) .....	11-63
11.16.1 Preparations before using the instrument .....	11-63
11.16.2 Installation of a semi-finished product.....	11-63
11.16.3 Connection steps.....	11-64
11.16.4 Running .....	11-71
11.17 JN5-CM-EIP Manual.....	11-75
11.17.1 Preparations before using the instrument .....	11-75
11.17.2 Installation of a semi-finished product.....	11-75
11.17.3 Connection steps .....	11-76
11.17.4 Running .....	11-83
11.18 Bluetooth LCD KEYPAD (JN5-OP-BTH) .....	11-87
11.18.1 Preparations before using the instrument .....	11-87
11.18.2 Connecting the Bluetooth APP with the motor drive Bluetooth LCD operator .....	11-87
<b>Appendix A: Communication Networks .....</b>	<b>A1-1</b>
A1.1 RS485-- Network (Modbus) .....	A1-1
<b>Appendix B: UL Instructions .....</b>	<b>B-1</b>
<b>Safety stop function instruction manual.....</b>	
<b>IE2 document .....</b>	

# Preface

The A510s product is an Inverter designed to control a three-phase induction motor. Please read this manual carefully to ensure correct operation, safety and to become familiar with the inverter functions.

The A510s inverter is an electrical / electronic product and must be installed and handled by qualified service personnel.

Improper handling may result in incorrect operation, shorter life cycle, or failure of this product as well as the motor.



All A510s documentation is subject to change without notice. Be sure to obtain the latest editions for use or visit our website at <http://industrialproducts.teco.com.tw/>



Available Documentation:

1. A510s Start-up and Installation Manual
2. A510s Instruction Manual

Ensure you have sound knowledge of the device and familiarize yourself with all safety information and precautions before proceeding to operate the inverter.

Ensure you have sound knowledge of the inverter and familiarize yourself with all safety information and precautions before proceeding to operate the inverter.

Please pay close attention to the safety precautions indicated by the warning  and caution  symbol.

 <b>Warning</b>	Failure to ignore the information indicated by the warning symbol may result in death or serious injury.
 <b>Caution</b>	Failure to ignore the information indicated by the caution symbol may result in minor or moderate injury and/or substantial property damage.



# Chapter 1 Safety Precautions

Users are advised to carefully read the safety precautions required in this chapter before installing, testing and repairing the system. Any personnel injury and equipment loss caused by illegal operation are irrelevant to the company and bear any responsibility.

## 1.1 Before Supplying Power to the Inverter

### Warning

The main circuit must be correctly wired. For single phase supply use input terminals (R/L1, T/L3) and for three phase supply use input terminals (R/L1, S/L2, T/L3). Terminals U/T1, V/T2, W/T3 must only be used to connect the motor. Connecting the input supply to any of the U/T1, V/T2 or W/T3 terminals will cause damage to the inverter.

### Caution

- To avoid the front cover from disengaging or other physical damage, do not carry the inverter by its cover. Support the unit by its heat sink when transporting. Improper handling can damage the inverter or injure personnel, and should be avoided.
- To avoid the risk of fire, do not install the inverter on or near flammable objects. Install on nonflammable objects such as metal surfaces.
- If several inverters are placed inside the same control panel, provide adequate ventilation to maintain the temperature below 40°C/104°F (50°C/122°F without a dust cover) to avoid overheating or fire.
- When removing or installing the digital operator, turn off the power first, and then follow the instructions in our instruction manual to avoid operator error or loss of display caused by faulty connections.

### Warning

- This product is sold subject to IEC 61800-3. In a domestic environment this product may cause radio interference in which case the user may need to apply corrective measures.
- Motor over temperature protection is provided.

## 1.2 Wiring

### Warning

- Always turn OFF the power supply before attempting inverter installation and wiring of the user terminals.
- Wiring must be performed by a qualified personnel / certified electrician.
- Make sure the inverter is properly grounded. (200V Class: Grounding impedance shall be less than 100Ω. 400V Class: Grounding impedance shall be less than 10Ω.)
- Make sure the inverter is properly grounded. It is required to disconnect the ground wire in the control board to avoid the sudden surge causing damage on electronic parts if it is improperly grounded.
- RCD is required to be in compliance with the protection norm of B-type leakage current.
- Please check and test emergency stop circuits after wiring. (Installer is responsible for the correct wiring.)
- Never touch any of the input or output power lines directly or allow any input of output power lines to

come in contact with the inverter case.

- Do not perform a dielectric voltage withstand test (megger) on the inverter this will result in inverter damage to the semiconductor components.

### **Caution**

- The line voltage applied must comply with the inverter's specified input voltage.
- Connect braking resistor and braking unit to the designated terminals.
- Do not connect a braking resistor directly to the DC terminals P (+) and N (-), otherwise fire may result.
- Use wire gauge recommendations and torque specifications.
- Never connect input power to the inverter output terminals U/T1, V/T2, W/T3.
- Do not connect a contactor or switch in series with the inverter and the motor.
- Do not connect a power factor correction capacitor or surge suppressor to the inverter output.
- Ensure the interference generated by the inverter and motor does not affect peripheral devices.

## 1.3 Before Operation

### **Warning**

- Make sure the inverter capacity matches the parameters 13-00.
- Reduce the carrier frequency (parameter 11-01) if the cable from the inverter to the motor is greater than 80 ft (25m). A high-frequency current can be generated by stray capacitance between the cables and result in an overcurrent trip of the inverter, an increase in leakage current, or an inaccurate current readout.
- Be sure to install all covers before turning on power. Do not remove any of the covers while power to the inverter is on, otherwise electric shock may occur.
- Do not operate switches with wet hands, otherwise electric shock may result.
- Do not touch inverter terminals when energized even if inverter has stopped, otherwise electric shock may result.

## 1.4 Parameters Setting

### **Caution**

- Do not connect a load to the motor while performing a rotational auto-tune.
- Make sure the motor can freely run and there is sufficient space around the motor when performing a rotational auto-tune.

## 1.5 Operation

### **Warning**

- Be sure to install all covers before turning on power. Do not remove any of the covers while power to the inverter is on, otherwise electric shock may occur.
- Do not connect or disconnect the motor during operation. This will cause the inverter to trip and may cause damage to the inverter.

- Operations may start suddenly if an alarm or fault is reset with a run command active. Confirm that no run command is active upon resetting the alarm or fault, otherwise accidents may occur.
- Do not operate switches with wet hands, otherwise electric shock may result.
- It provides an independent external hardware emergency switch, which emergently shuts down the inverter output in the case of danger.
- If automatic restart after power recovery (parameter 07-00) is enabled, the inverter will start automatically after power is restored.
- Make sure it is safe to operate the inverter and motor before performing a rotational auto-tune.
- Do not touch inverter terminals when energized even if inverter has stopped, otherwise electric shock may result.
- Do not check signals on circuit boards while the inverter is running.  
After the power is turned off, the cooling fan may continue to run for some time.

 **Caution**

- Do not touch heat-generating components such as heat sinks and braking resistors.
- Carefully check the performance of motor or machine before operating at high speed, otherwise Injury may result.
- Note the parameter settings related to the braking unit when applicable.
- Do not use the inverter braking function for mechanical holding, otherwise injury may result.  
Do not check signals on circuit boards while the inverter is running.

## 1.6 Maintenance, Inspection and Replacement

 **Warning**

- Wait a minimum of five minutes after power has been turned OFF before starting an inspection. Also confirm that the charge light is OFF and that the DC bus voltage has dropped below 25Vdc.
- Never touch high voltage terminals in the inverter.
- Make sure power to the inverter is disconnected before disassembling the inverter.
- Only authorized personnel should perform maintenance, inspection, and replacement operations. (Take off metal jewelry such as watches and rings and use insulated tools.)

 **Caution**

- The Inverter can be used in an environment with a temperature range from 14° ~104(140) °F (-10~+40(60)°C) and relative humidity of 95% non-condensing.
- The inverter must be operated in a dust, gas, mist and moisture free environment.

## 1.7 Disposal of the Inverter

### Caution

- Please dispose of this unit with care as an industrial waste and according to your required local regulations.
- The capacitors of inverter main circuit and printed circuit board are considered as hazardous waste and must not be burned.
- The Plastic enclosure and parts of the inverter such as the top cover board will release harmful gases if burned.



Equipment containing electrical components may not be disposed of together with domestic waste. It must be separately collected with electrical and electronic waste according to local and currently valid legislation.

## 1.8 Guaranteed liability exemption

- Loss of opportunity caused by the company's products, damage to customers of your company or your company, damage to non-company products, or compensation for other businesses, whether within the warranty period or not, is not covered by the company.

# Chapter 2 Model Description

## 2.1 Nameplate Data

It is essential to verify the A510s inverter nameplate and make sure that the A510s inverter has the correct rating so it can be used in your application with the proper sized AC motor.

### Unpack the A510s inverter and check the following:

- (1) The A510s inverter and start-up and installation manual are contained in the package.
- (2) The A510s inverter has not been damaged during transportation there should be no dents or parts missing.
- (3) The A510s inverter is the type you ordered. You can check the type and specifications on the main nameplate.
- (4) Check that the input voltage range meets the input power requirements.
- (5) Ensure that the motor HP matches the motor rating of the inverter.

HD: Heavy Duty (Constant Torque); ND: Normal Duty (Variable Torque) (1HP = 0.746 kW)

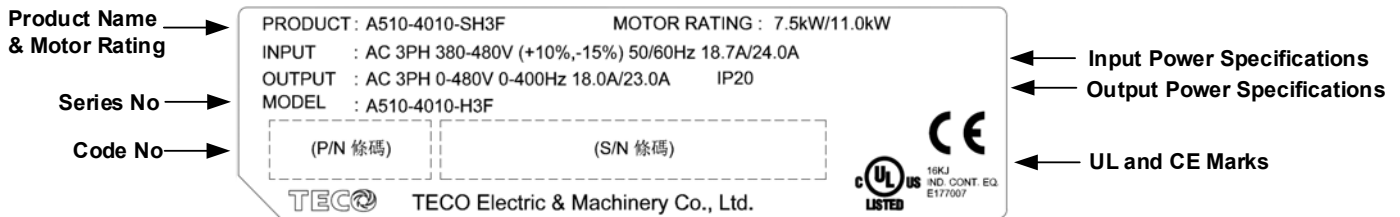

## Model Identification

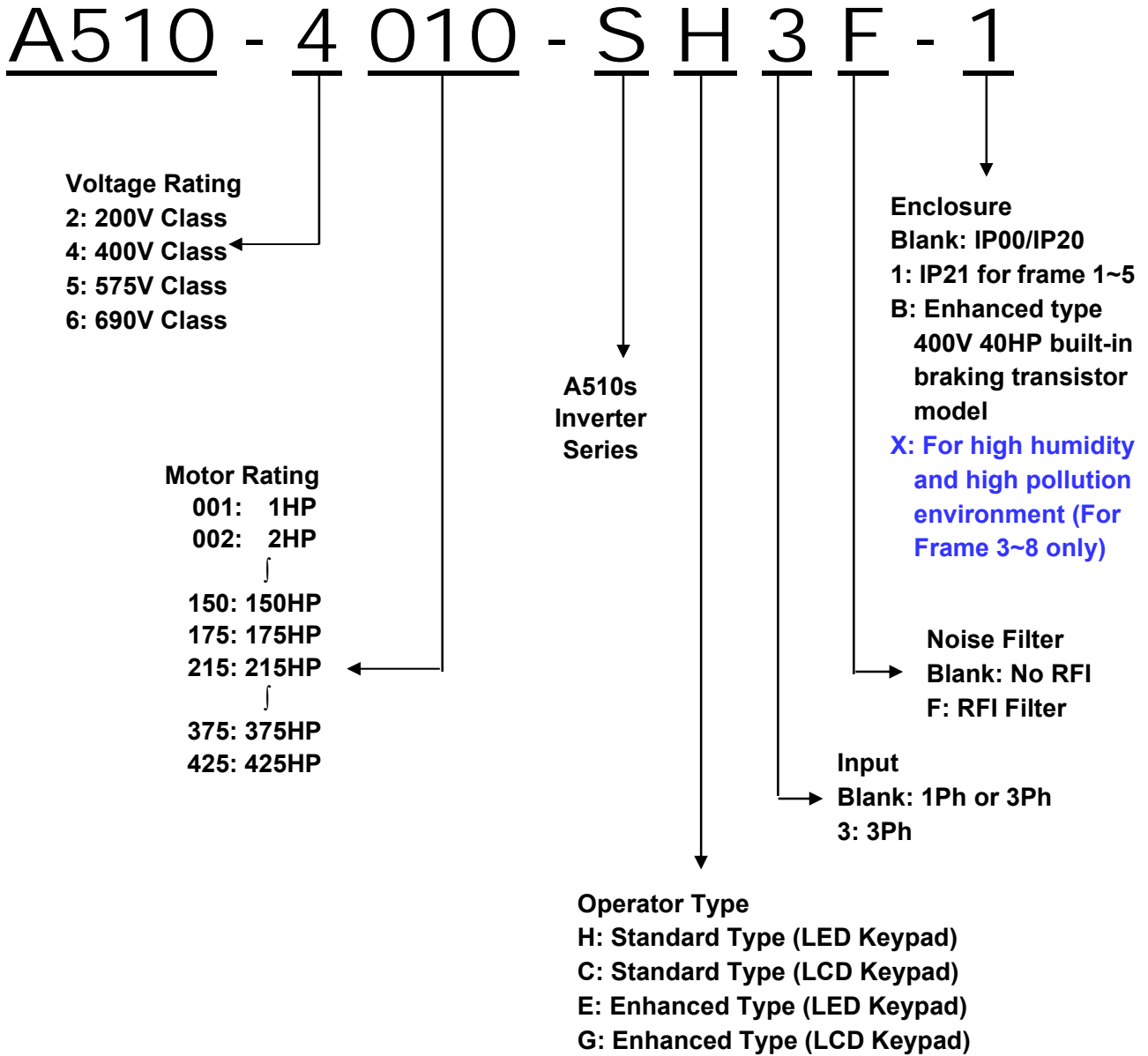

## 2.2 Inverter Models – Motor Power Rating (HD – Heavy Duty)

### 200V Class

Voltage	A510s Model	Applied Motor (HP)	Applied Motor (KW)	Filter	
				with	without
1ph/3ph, 200~240V +10%/-15% 50/60Hz	A510-2001-S□	1	0.75		◎
	A510-2002-S□	2	1.5		◎
	A510-2003-S□	3	2.2		◎
3ph, 200~240V +10%/-15% 50/60Hz	A510-2005-S□3	5	3.7		◎
	A510-2008-S□3	7.5	5.5		◎
	A510-2010-S□3	10	7.5		◎
	A510-2015-S□3	15	11		◎
	A510-2020-S□3	20	15		◎
	A510-2025-S□3	25	18.5		◎
	A510-2030-S□3	30	22		◎
	A510-2040-S□3	40	30		◎
	A510-2050-S□3	50	37		◎
	A510-2060-S□3	60	45		◎
	A510-2075-S□3	75	55		◎
	A510-2100-S□3	100	75		◎
	A510-2125-S□3	125	94		◎
A510-2150-S□3	150	112		◎	

**400V Class**

Voltage	A510s Model	Applied Motor (HP)	Applied Motor (KW)	Filter	
				with	without
3ph, 380~480V +10%/-15% 50/60Hz	A510-4001-S□3	1	0.75		⊙
	A510-4001-S□3F	1	0.75	⊙	
	A510-4002-S□3	2	1.5		⊙
	A510-4002-S□3F	2	1.5	⊙	
	A510-4003-S□3	3	2.2		⊙
	A510-4003-S□3F	3	2.2	⊙	
	A510-4005-S□3	5	3.7		⊙
	A510-4005-S□3F	5	3.7	⊙	
	A510-4008-S□3	7.5	5.5		⊙
	A510-4008-S□3F	7.5	5.5	⊙	
	A510-4010-S□3	10	7.5		⊙
	A510-4010-S□3F	10	7.5	⊙	
	A510-4015-S□3	15	11		⊙
	A510-4015-S□3F	15	11	⊙	
	A510-4020-S□3	20	15		⊙
	A510-4020-S□3F	20	15	⊙	
	A510-4025-S□3	25	18.5		⊙
	A510-4025-S□3F	25	18.5	⊙	
	A510-4030-S□3	30	22		⊙
	A510-4030-S□3F	30	22	⊙	
	A510-4040-S□3	40	30		⊙
	A510-4040-S□3F	40	30	⊙	
	A510-4050-S□3	50	37		⊙
	A510-4050-S□3F	50	37	⊙	
	A510-4060-S□3	60	45		⊙
	A510-4060-S□3F	60	45	⊙	
	A510-4075-S□3	75	55		⊙
	A510-4100-S□3	100	75		⊙
	A510-4125-S□3	125	94		⊙
	A510-4150-S□3	150	112		⊙
A510-4175-S□3	175	130		⊙	
A510-4215-S□3	215	160		⊙	
A510-4270-S□3	270	200		⊙	
A510-4300-S□3	300	220		⊙	
A510-4375-S□3	375	280		⊙	
A510-4425-S□3	425	315		⊙	



**575/690V Class**

Voltage	A510s Model	Applied Motor (HP)	Applied Motor (KW)	Filter	
				with	without
3ph, 500~600V +10%/-15% 50/60Hz	A510-5001-S□3	1	0.75		⊙
	A510-5002-S□3	2	1.5		⊙
	A510-5003-S□3	3	2.2		⊙
	A510-5005-S□3	5	3.7		⊙
	A510-5008-S□3	7.5	5.5		⊙
	A510-5010-S□3	10	7.5		⊙
3ph, 575~690V +10%/-15% 50/60Hz	A510-6015-S□3	15	11		⊙
	A510-6020-S□3	20	15		⊙
	A510-6025-S□3	25	18.5		⊙
	A510-6030-S□3	30	22		⊙
	A510-6040-S□3	40	30		⊙
	A510-6050-S□3	50	37		⊙
	A510-6060-S□3	60	45		⊙
	A510-6075-S□3	75	55		⊙
	A510-6100-S□3	100	75		⊙
	A510-6125-S□3	125	94		⊙
	A510-6150-S□3	150	112		⊙
	A510-6175-S□3	175	130		⊙
	A510-6215-S□3	215	160		⊙
	A510-6250-S□3	250	185		⊙
A510-6270-S□3	270	200		⊙	

# Chapter 3 Environment and Installation

## 3.1 Environment

The environment will directly affect the proper operation and the life span of the inverter. To ensure that the inverter will give maximum service life, please comply with the following environmental conditions:

Protection	
Protection Class	IP20/IP21/NEMA 1 or IP00
Operating Temperature	IP20/IP21: -10°C - +40°C (14 -104 °F) IP00 or without cover: -10°C - +50°C (14-122 °F) Enhanced type frame 5 is 50°C without de-rating. The maximum operating temperature is <b>60°C</b> , but it is required to derate 2% of current at each additional 1°C. If several inverters are placed in the same control panel, provide a heat removal means to maintain ambient temperatures
Storage Temperature	-20°C - +70°C (-4 -158 °F)
Humidity	95% non-condensing Relative humidity 5% to 95%, free of moisture. (Follow IEC60068-2-78 standard)
Altitude	Altitude: Below 1000 m (3281 ft.) It is required to derate 1% of current at each additional 100 m. The maximum altitude is <b>3000 m</b> .
Installation Site	Avoid exposure to rain or moisture.
	Avoid direct sunlight.
	Avoid oil mist and salinity.
	Avoid corrosive liquid and gas.
	Avoid dust, lint fibers, and small metal filings.
	Keep away from radioactive and flammable materials.
	Avoid electromagnetic interference (soldering machines, power machines).
Avoid vibration (stamping, punching machines etc.). Add a vibration-proof pad if the situation cannot be avoided.	
Shock	Maximum acceleration: 1.0G (9.8m/s <sup>2</sup> ), from 49.84 to 150 Hz Displacement amplitude : 0.3mm (peak value), from 10 to 49.84 Hz (Follow IEC60068-2-6 standard)

## 3.2 Installation

When installing the inverter, ensure that inverter is installed in upright position (vertical direction) and there is adequate space around the unit to allow normal heat dissipation as per the following Fig. 3.2.1

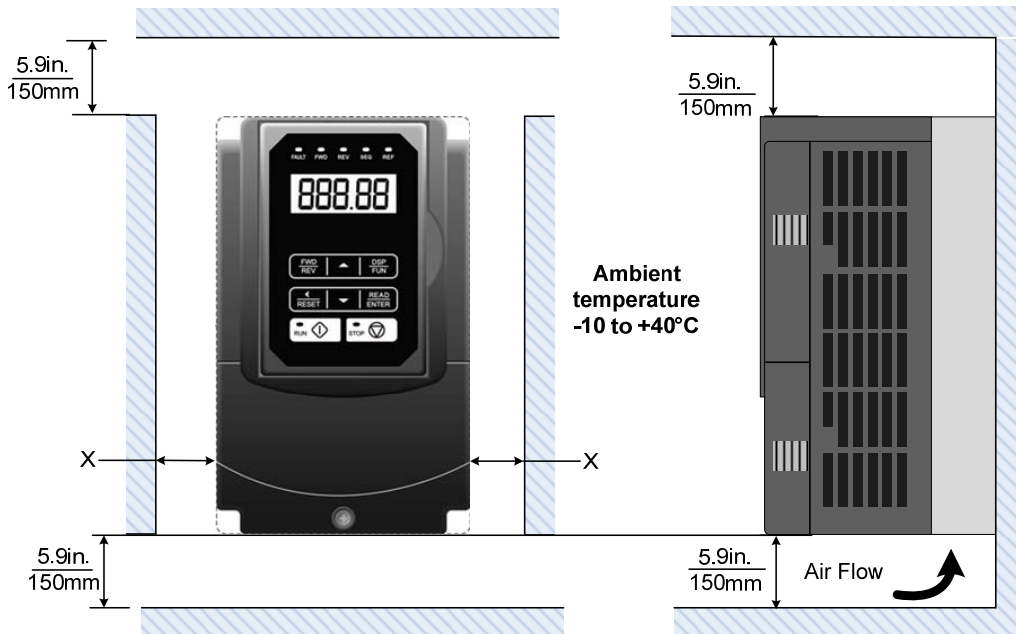

Fig 3.2.1: A510s Installation space

**X = 1.18" (30mm) for inverter ratings up to 25HP**

**X = 1.96" (50mm) for inverter ratings 30HP or higher**

**Important Note:** The inverter heatsink temperature can reach up to 194°F / 90°C during operation; make sure to use insulation material rated for this temperature.

### 3.3 External View

(a) 200V 1 ~ 7.5 HP / 400V 1 ~ 7.5 HP / 575V 1~ 3 HP

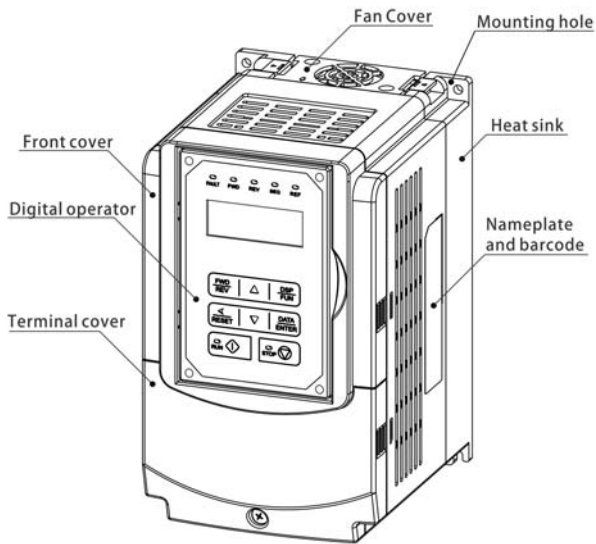

(Wall-mounted type, IEC IP20)

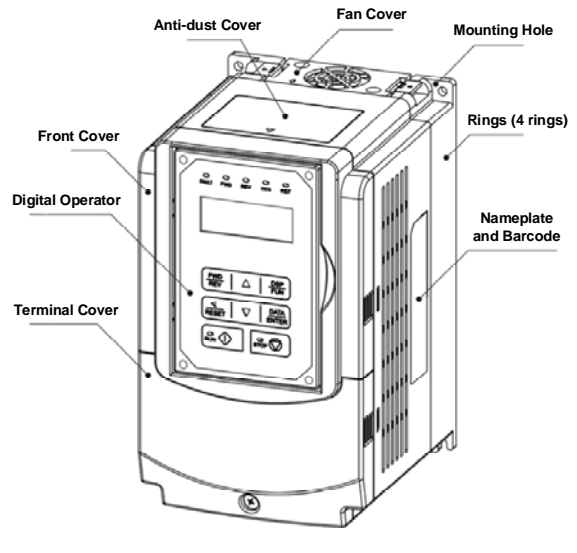

(Wall-mounted type, IEC IP20, NEMA1)

(b) 200V 10 ~ 25 HP / 400V 10 ~ 30 HP / 575V 5~10HP / 690V 15~40HP

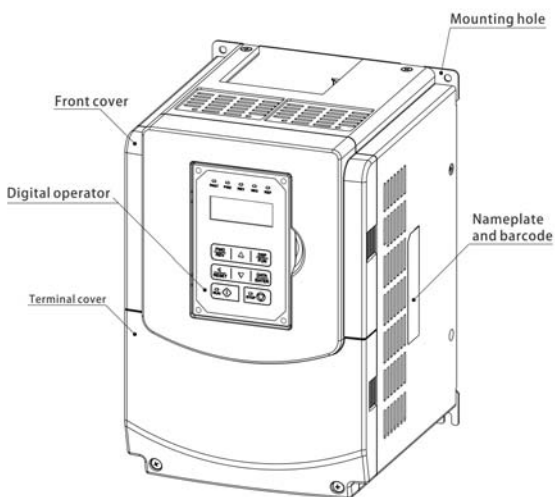

(Wall-mounted type, IEC IP20)

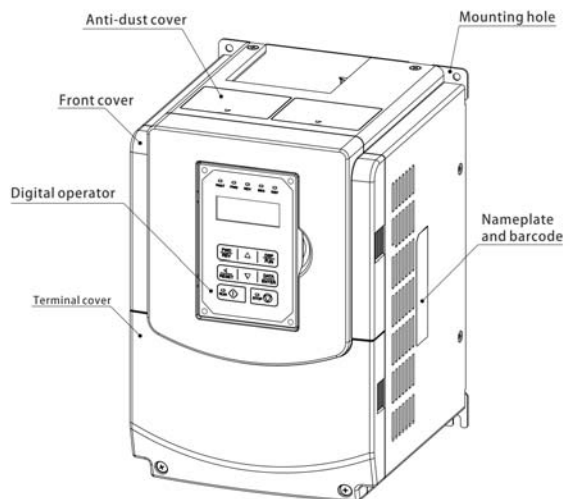

(Wall-mounted type, IEC IP20, NEMA1)

**(c) 200V 30 ~ 40 HP / 400V 40 ~ 75 HP / 690V 50~75HP**

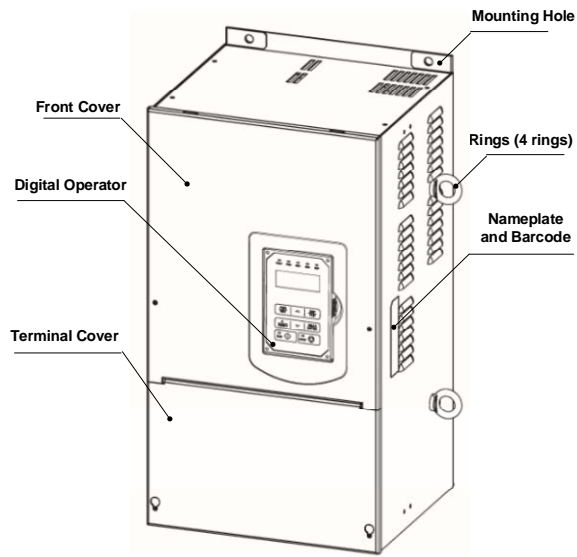

**(Wall-mounted type, IEC IP20, NEMA1)**

**(d) 200V 50 ~ 100 HP / 400V 100 ~ 215 HP / 690V 100~270HP**

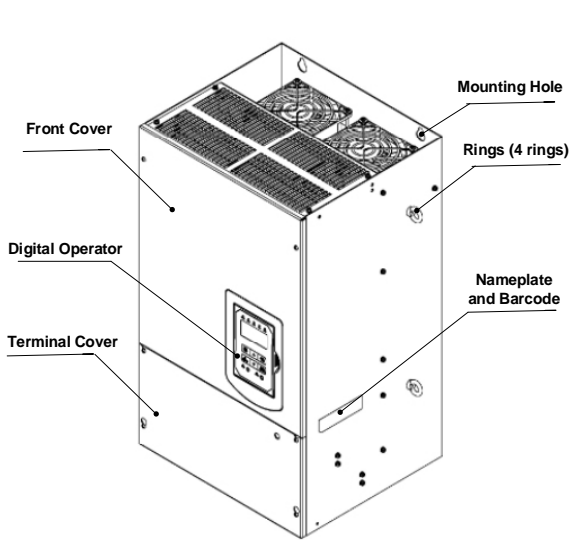

**(Wall-mounted type, IEC IP00)**

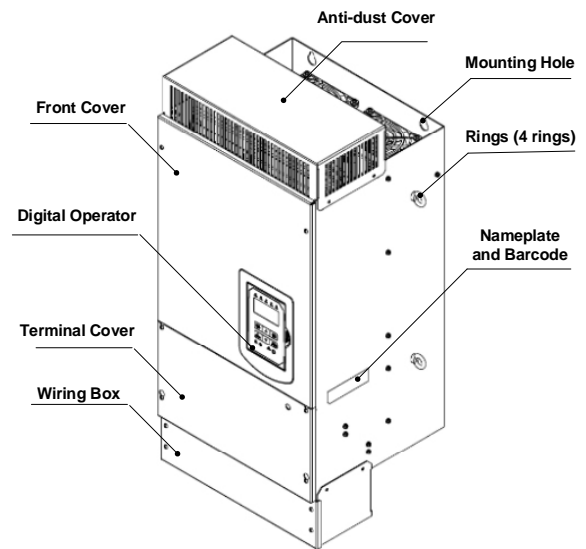

**(Wall-mounted type, IEC IP20, NEMA1)**

**(e) 200V 125 ~ 150 HP / 400V 270 ~ 425 HP**

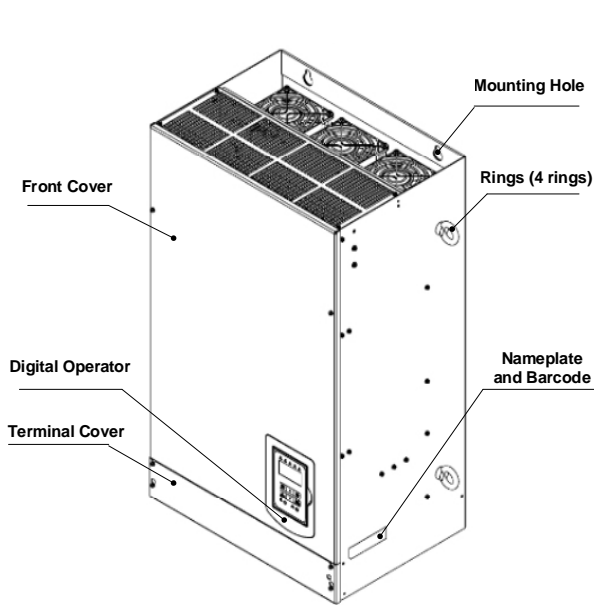

**(Wall-mounted type, IEC IP00)**

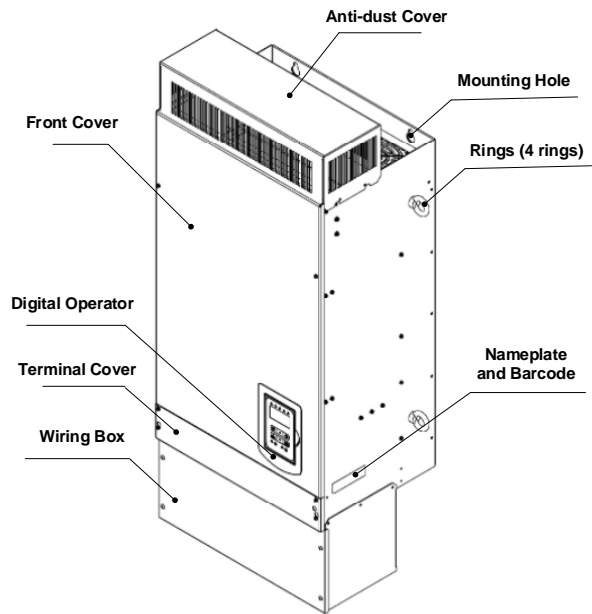

**(Wall-mounted type, IEC IP20, NEMA1)**

### 3.4 Warning Labels

**Important:** Warning information located on the front cover must be read upon installation of the inverter.



**(a) 200V: 1-7.5HP / 400V: 1-7.5HP / 575V 1~ 3 HP**



**(b) 200V: 10HP / 400V: 10-20HP / 575V 5~10HP**

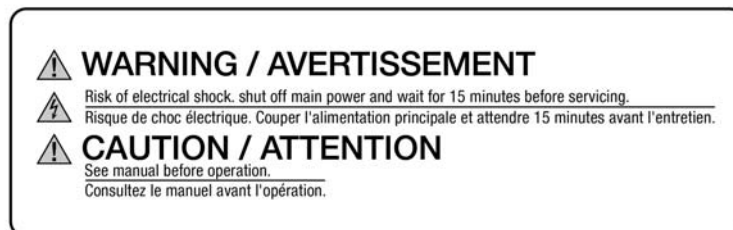

**(c) 200V: 15-150HP / 400V: 20(F)-425HP/690V 15~270HP**

## 3.5 Removing the Front Cover and Keypad



### Caution

- Before making any wiring connections to the inverter the front cover needs to be removed.
- It is not required to remove the digital operator before making any wiring connections.
- Models 200V, 1 – 25 HP and 400V, 1 – 30 HP and 575V/690V 1 – 40 HP have a plastic cover. Loosen the screws and remove the cover to gain access to the terminals and make wiring connections. Place the plastic cover back and fasten screws when wiring connections have been made.
- Models 200V, 30 - 150HP and 400V, 40 - 425HP and 690V 50 - 270HP have a metal cover. Loosen the screws and remove the cover to gain access to the terminals and make wiring connections. Place the metal cover back and fasten screws when wiring connections have been made.

### 3.5.1 Without Built-in filter type

(a) 200V: 1 ~ 7.5 HP / 400V: 1 ~ 7.5 HP /575V: 1~3HP

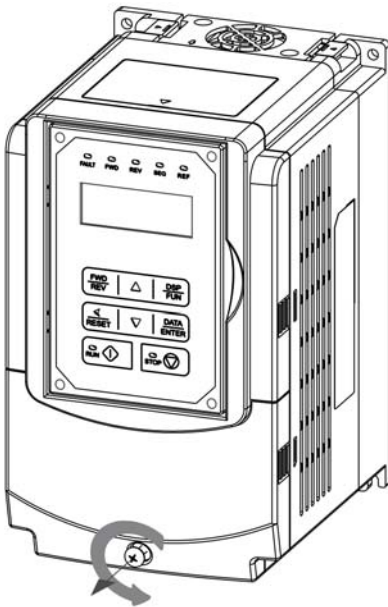

**Step 1:** Unscrew

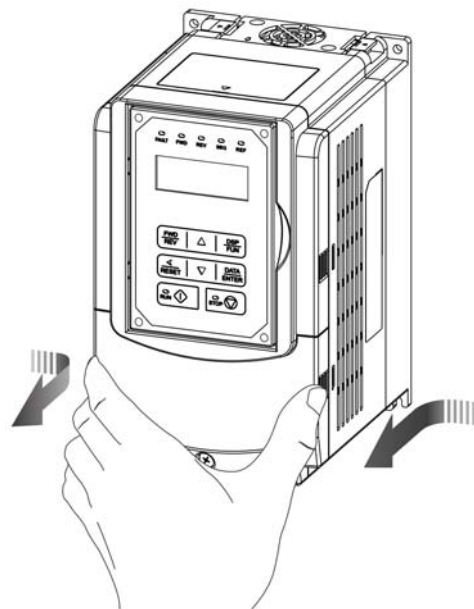

**Step 2:** Remove cover

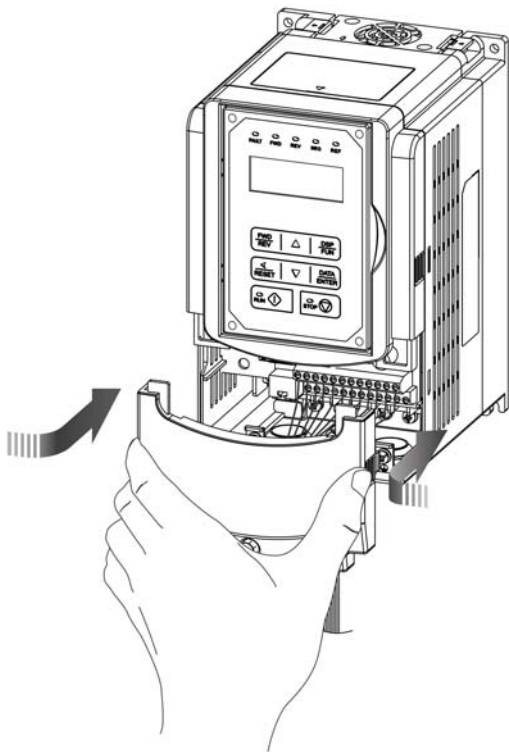

**Step 3:** Make wire connections and place cover back

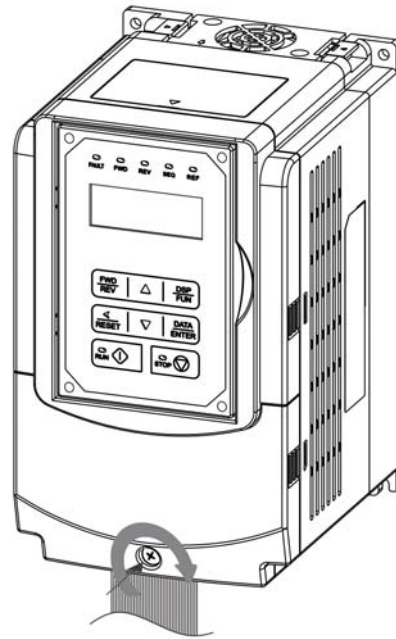

**Step 4:** Fasten screw

**(b) 200V: 10 ~ 25 HP / 400V: 10 ~ 30 HP / 575V: 5~10HP/690V 15~40HP**

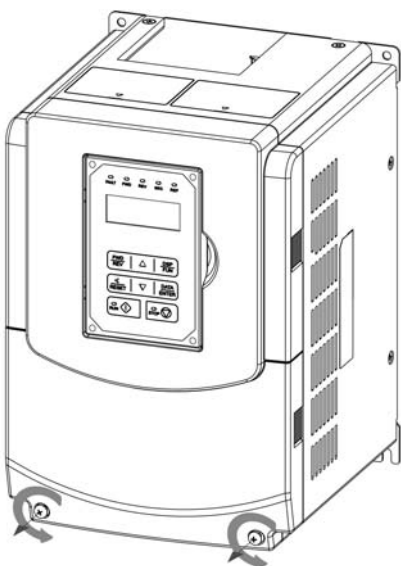

**Step 1:** Unscrew cover

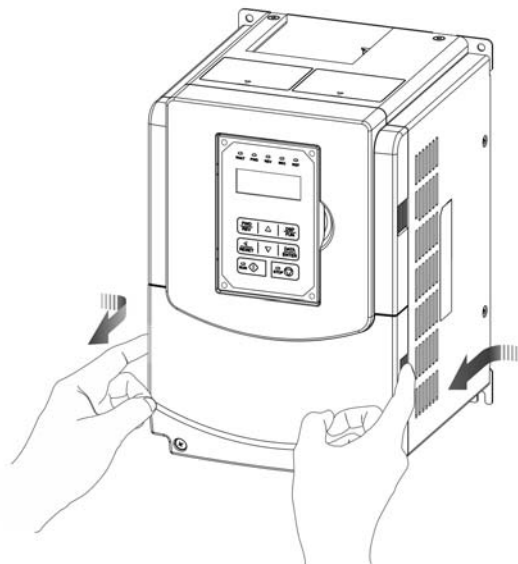

**Step 2:** Remove cover



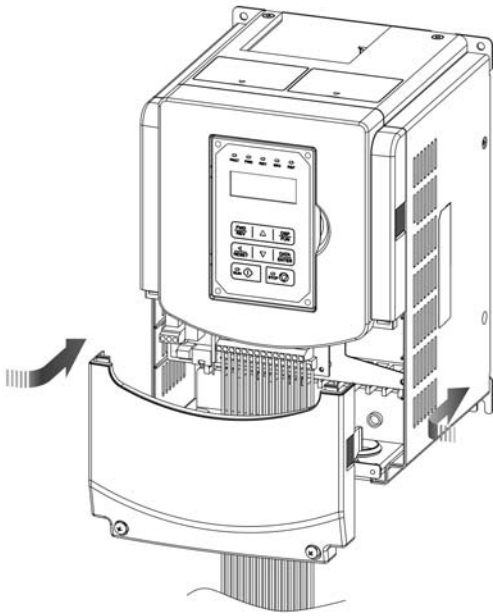

**Step 3:** Make wire connections and place cover back

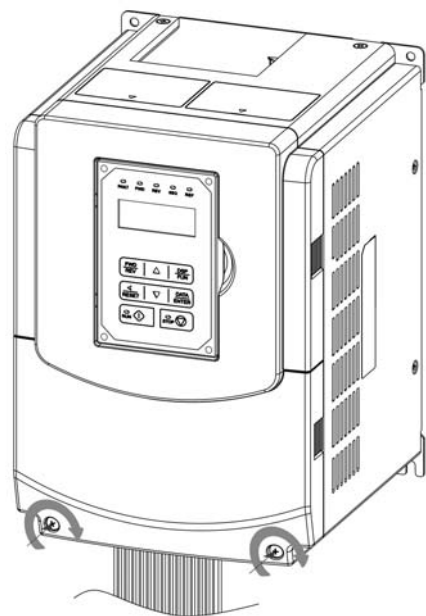

**Step 4:** Fasten screw

**(c) 200V: 30 ~ 40 HP / 400V: 40 ~ 75 HP / 690V: 50~75HP (Chassis Type)**

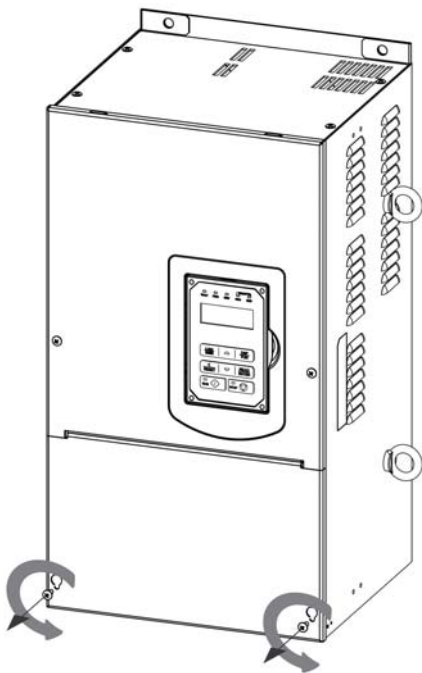

**Step 1:** Unscrew cover

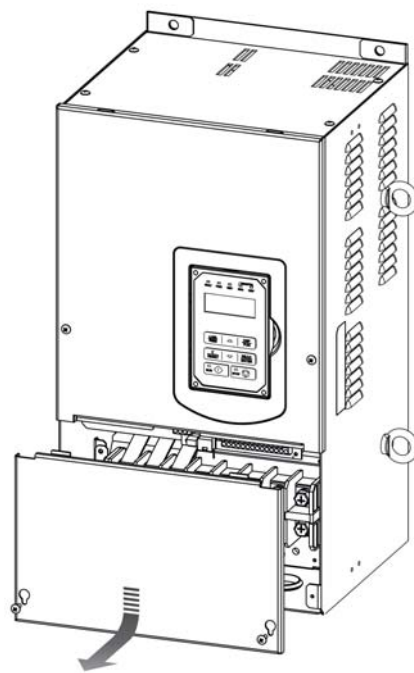

**Step 2:** Remove cover

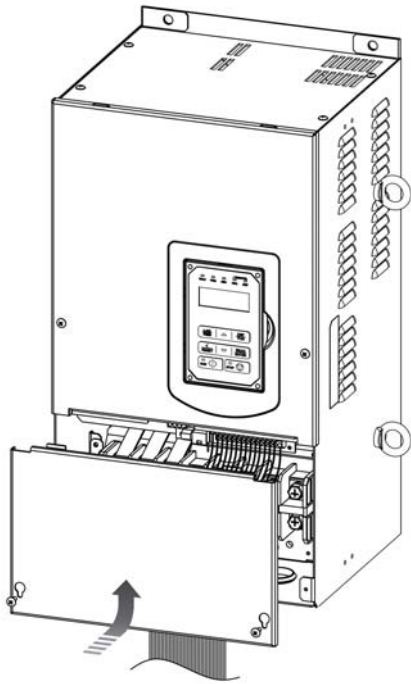

**Step 3:** Make wire connections and place cover back

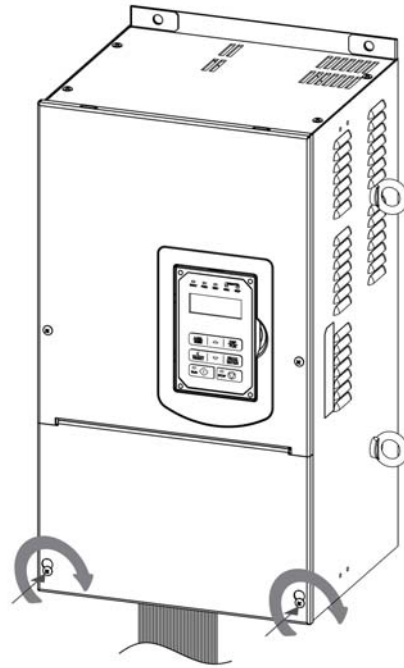

**Step 4:** Fasten screw

**(d) 200V: 50 ~ 100 HP / 400V: 100 ~ 215 HP / 690V: 100~270HP (Chassis Type)**

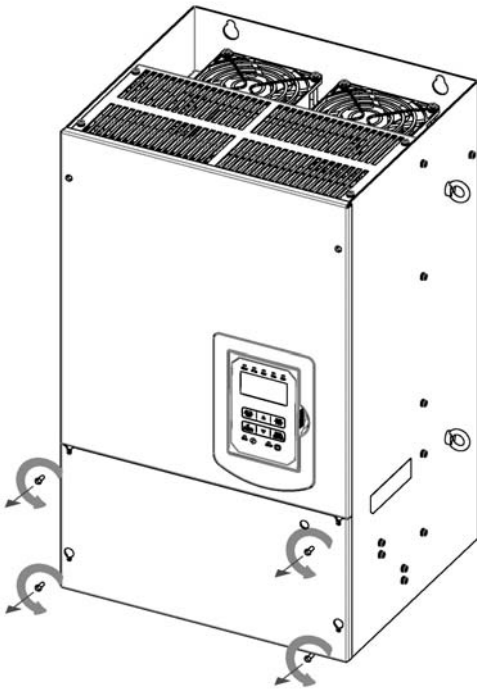

**Step 1:** Unscrew cover

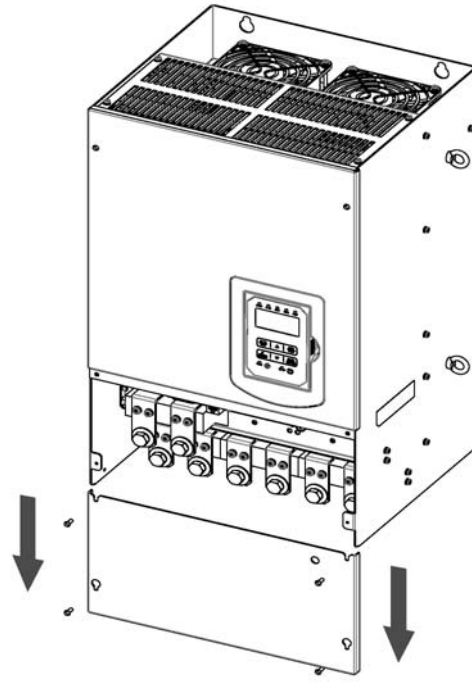

**Step 2:** Remove cover

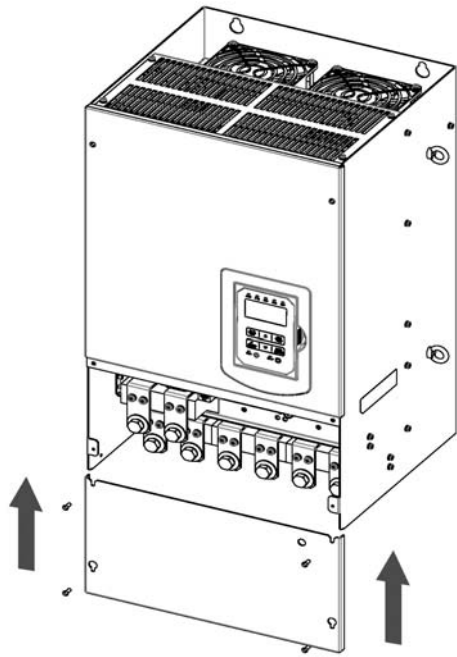

**Step 3:** Make wire connections and place cover back

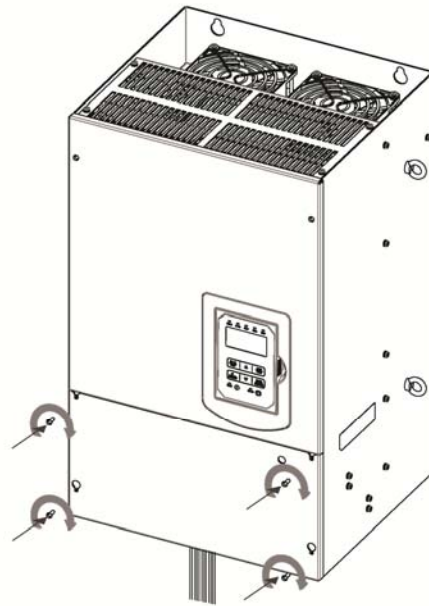

**Step 4:** Fasten screw

**(e) 200V: 125 ~ 150 HP / 400V: 270 ~ 425 HP (Chassis Type)**

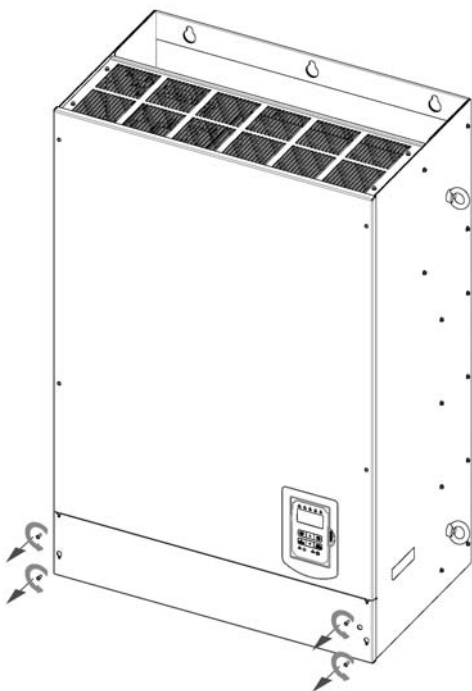

**Step 1:** Unscrew cover

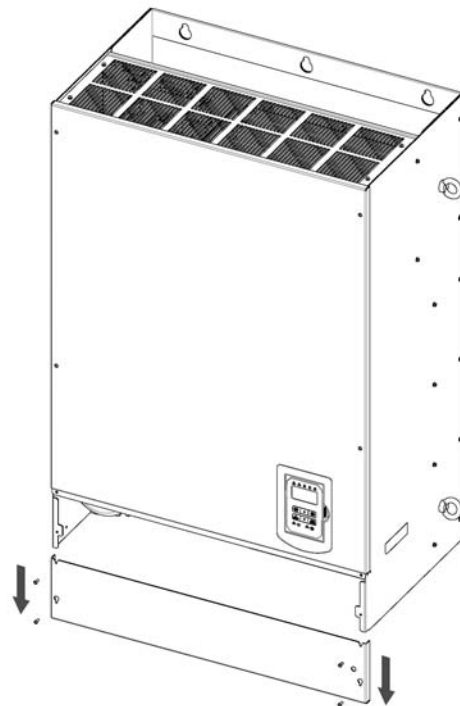

**Step 2:** Remove cover

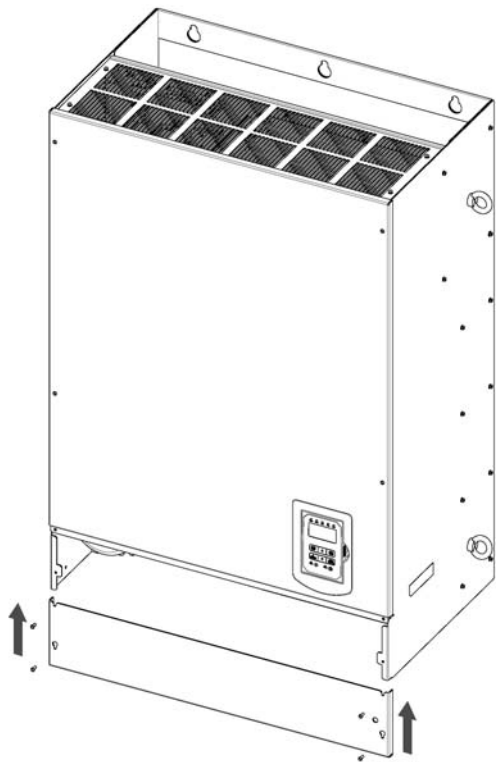

**Step 3:** Make wire connections and place cover back

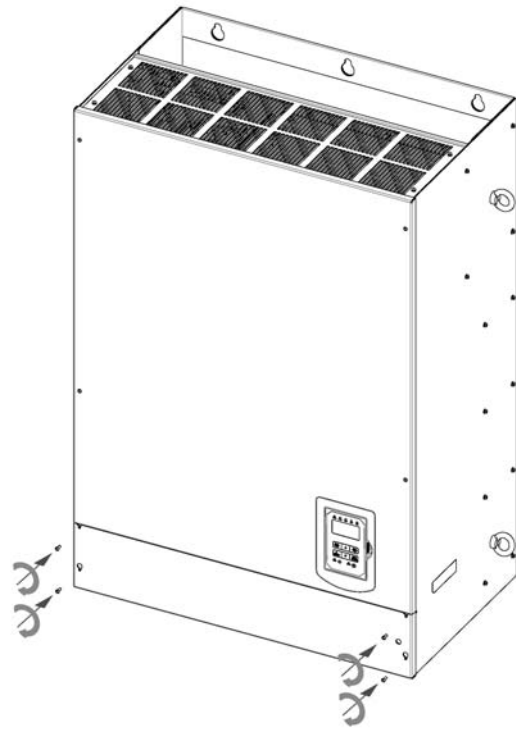

**Step 4:** Fasten screw

### 3.5.2 Built-in filter type (400V: 1 ~ 60 HP)

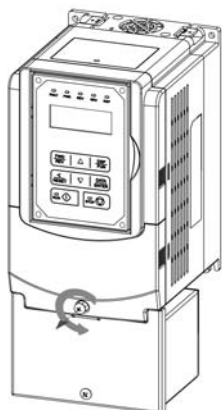

**Step 1:** Unscrew cover

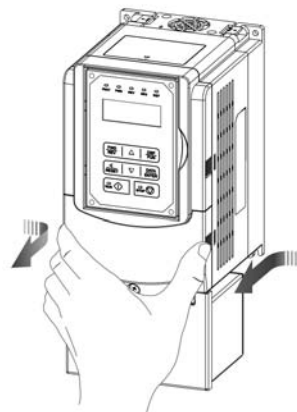

**Step 2:** Remove cover

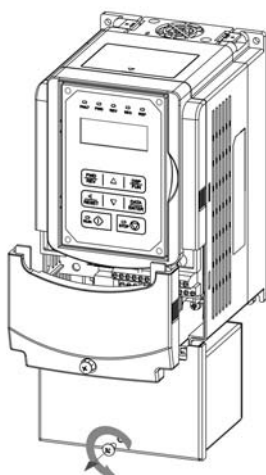

**Step 3:** Unscrew filter section

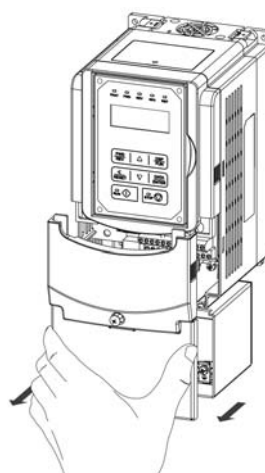

**Step 4:** Remove filter cover

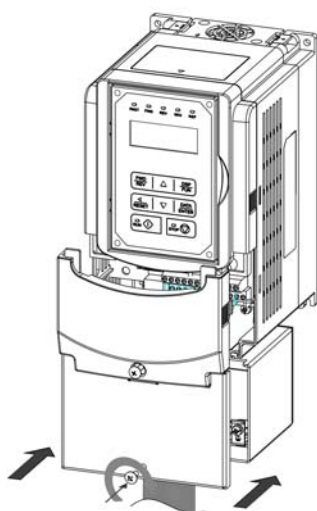

**Step 5:** Make connections and place filter cover back

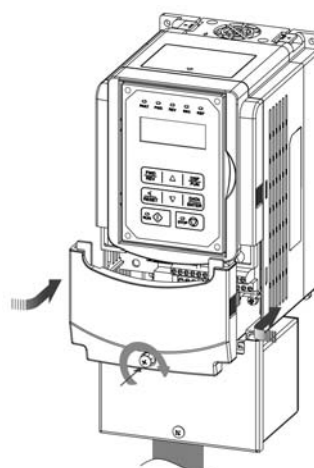

**Step 6:** Fasten screw

### 3.6 Wire Gauges and Tightening Torque

To comply with UL standards, use UL approved copper wires (rated 75° C) and round crimp terminals (UL Listed products) as shown in table below when connecting to the main circuit terminals. TECO recommends using crimp terminals manufactured by NICHIFU Terminal Industry Co., Ltd and the terminal crimping tool recommended by the manufacturer for crimping terminals and the insulating sleeve.

Wire size mm <sup>2</sup> (AWG)	Terminal screw size	Model of the round crimp terminal	Fastening torque kgf.cm (in.lbs)	Model of insulating sleeve	Model of crimp tool
0.75 (18)	M3.5	R1.25-3.5	8.2 to 10 (7.1 to 8.7)	TIC 1.25	NH 1
	M4	R1.25-4	12.2 to 14 (10.4 to 12.1)	TIC 1.25	NH 1
1.25 (16)	M3.5	R1.25-3.5	8.2 to 10 (7.1 to 8.7)	TIC 1.25	NH 1
	M4	R1.25-4	12.2 to 14 (10.4 to 12.1)	TIC 1.25	NH 1
2 (14)	M3.5	R2-3.5	8.2 to 10 (7.1 to 8.7)	TIC 2	NH 1 / 9
	M4	R2-4	12.2 to 14 (10.4 to 12.1)	TIC 2	NH 1 / 9
	M5	R2-5	22.1 to 24 (17.7 to 20.8)	TIC 2	NH 1 / 9
	M6	R2-6	25.5 to 30.0 (22.1 to 26.0)	TIC 2	NH 1 / 9
3.5 / 5.5 (12/10)	M4	R5.5-4	12.2 to 14 (10.4 to 12.1)	TIC 5.5	NH 1 / 9
	M5	R5.5-5	20.4 to 24 (17.7 to 20.8)	TIC 5.5	NH 1 / 9
	M6	R5.5-6	25.5 to 30.0 (22.1 to 26.0)	TIC 5.5	NH 1 / 9
	M8	R5.5-8	61.2 to 66.0 (53.0 to 57.2)	TIC 5.5	NH 1 / 9
8 (8)	M4	R8-4	12.2 to 14 (10.4 to 12.1)	TIC 8	NOP 60
	M5	R8-5	20.4 to 24 (17.7 to 20.8)	TIC 8	NOP 60
	M6	R8-6	25.5 to 30.0 (22.1 to 26.0)	TIC 8	NOP 60
	M8	R8-8	61.2 to 66.0 (53.0 to 57.2)	TIC 8	NOP 60
14 (6)	M4	R14-4	12.2 to 14 (10.4 to 12.1)	TIC 14	NH 1 / 9
	M5	R14-5	20.4 to 24 (17.7 to 20.8)	TIC 14	NH 1 / 9
	M6	R14-6	25.5 to 30.0 (22.1 to 26.0)	TIC 14	NH 1 / 9
	M8	R14-8	61.2 to 66.0 (53.0 to 57.2)	TIC 14	NH 1 / 9
22 (4)	M6	R22-6	25.5 to 30.0 (22.1 to 26.0)	TIC 22	NOP 60/ 150H
	M8	R22-8	61.2 to 66.0 (53.0 to 57.2)	TIC 22	NOP 60/ 150H
30 / 38 (3 / 2)	M6	R38-6	25.5 to 30.0 (22.1 to 26.0)	TIC 38	NOP 60/ 150H
	M8	R38-8	61.2 to 66.0 (53.0 to 57.2)	TIC 38	NOP 60/ 150H
50 / 60 (1/1/0)	M8	R60-8	61.2 to 66.0 (53.0 to 57.2)	TIC 60	NOP 60/ 150H
	M10	R60-10	102 to 120 (88.5 to 104)	TIC 60	NOP 150H
70 (2/0)	M8	R70-8	61.2 to 66.0 (53.0 to 57.2)	TIC 60	NOP 150H
	M10	R70-10	102 to 120 (88.5 to 104)	TIC 60	NOP 150H
80 (3/0)	M10	R80-10	102 to 120 (88.5 to 104)	TIC 80	NOP 150H
	M16	R80-16	255 to 280 (221 to 243)	TIC 80	NOP 150H
100 (4/0)	M10	R100-10	102 to 120 (88.5 to 104)	TIC 100	NOP 150H
	M12	R100-12	143 to 157 (124 to 136)	TIC 100	NOP 150H
	M16	R80-16	255 to 280 (221 to 243)	TIC 80	NOP 150H

## Main Circuit Terminal Wiring

UL approval requires crimp terminals when wiring the inverter's main circuit terminals. Use crimping tools as specified by the crimp terminal manufacturer. Teco recommends crimp terminals made by NICHIFU for the insulation cap.

The table below matches inverter models with crimp terminals and insulation caps.

Closed-Loop Crimp Terminal Size

Drive Model A510s	Wire Gauge mm <sup>2</sup> , (AWG / MCM)		Terminal	Crimp Terminal	Tool	Insulation Cap
	R/L1 • S/L2 • T/L3	U/T1 • V/T2 • W/T3	Screws	Model No.	Machine No.	Model No.
2001	2 (14) / 3.5 (12) / 5.3 (10)		M4	R2-4/R3.5-4/R5.5-4	Nichifu NH 1 / 9	TIC 2/ 3.5/ 5.5
2002	2 (14) / 3.5 (12) / 5.3 (10)		M4	R2-4/R3.5-4/R5.5-4	Nichifu NH 1 / 9	TIC 2/ 3.5/ 5.5
2003	3.5 (12) / 5.3 (10)		M4	R3.5-4 / R5.5-4	Nichifu NH 1 / 9	TIC 3.5/ 5.5
2005	5.3 (10)		M4	R5.5-4	Nichifu NH 1 / 9	TIC 5.5
2008	8.4 (8)		M4	R8-4	Nichifu NOP 60 ; NH 1 / 9	TIC 8
2010	8.4 (8)		M6	R8-6	Nichifu NOP 60 ; NH 1 / 9	TIC 8
2015	13.3 (6)		M6	R14-6	Nichifu NOP 60 / 150HA	TIC 14
2020	21.2 (4)		M6	R22-6	Nichifu NOP 60 / 150HA	TIC 22
2025	21.2 (4)		M6	R22-6	Nichifu NOP 60 / 150HA	TIC 22
2030	33.6 (2)		M8	R38-8	Nichifu NOP 60 / 150HA	TIC 38
2040	67.4 (1/0)		M8	R60-8	Nichifu NOP 60 / 150HA	TIC 60
2060	107.2 (4/0)		M10	R100-10	Nichifu NOP 150HA	TIC 100
2075	152 (300MCM)		M10	R150-10	Nichifu NOP 150HA	TIC 150
2100	200 (400MCM)		M10	R200-10	Nichifu NOP 700 & NOH300K	TIC 200
2125	300 (600MCM)		M12	R325-12S	Nichifu NOP 700 & NOH300K	TIC 325
2150	250 (500MCM) * 2		M12	R250-12	Nichifu NOP 700 & NOH300K	TIC 250
4001	2 (14) / 3.5 (12) / 5.3 (10)		M4	R2-4/R3.5-4/R5.5-4	Nichifu NH 1 / 9	TIC 2/ 3.5/ 5.5
4002	2 (14) / 3.5 (12) / 5.3 (10)		M4	R2-4/R3.5-4/R5.5-4	Nichifu NH 1 / 9	TIC 2/ 3.5/ 5.5
4003	2 (14) / 3.5 (12) / 5.3 (10)		M4	R2-4/R3.5-4/R5.5-4	Nichifu NH 1 / 9	TIC 2/ 3.5/ 5.5
4005	2 (14) / 3.5 (12) / 5.3 (10)		M4	R2-4/R3.5-4/R5.5-4	Nichifu NH 1 / 9	TIC 2/ 3.5/ 5.5
4008	3.5 (12) / 5.3 (10)		M4	R3.5-4 / R5.5-4	Nichifu NH 1 / 9	TIC 3.5/ 5.5
4010	3.5 (12) / 5.3 (10)		M4	R3.5-4 / R5.5-4	Nichifu NH 1 / 9	TIC 3.5/ 5.5
4015	8.4 (8)		M6	R8-6	Nichifu NOP 60 ; NH 1 / 9	TIC 8
4020	8.4 (8)		M6	R8-6	Nichifu NOP 60 ; NH 1 / 9	TIC 8
4025	8.4 (8)		M6	R8-6	Nichifu NOP 60 ; NH 1 / 9	TIC 8
4030	13.3 (6)		M6	R14-6	Nichifu NOP 60 / 150HA	TIC 14
4040-B	21.2 (4)		M6	R22-6	Nichifu NOP 60 / 150HA	TIC 22
4040	21.2 (4)		M8	R22-8	Nichifu NOP 60 / 150HA	TIC 22
4050	21.2 (4)		M8	R22-8	Nichifu NOP 60 / 150HA	TIC 22
4060	33.6 (2)		M8	R38-8	Nichifu NOP 60 / 150HA	TIC 38
4075	67.4 (2/0)		M8	R70-8	Nichifu NOP 60 / 150HA	TIC 70
4100	85 (3/0)		M10	R80-10	Nichifu NOP 60 / 150HA	TIC 80
4125	152 (300MCM)		M10	R100-10	Nichifu NOP 60 / 150HA	TIC 100
4150	152 (300MCM)		M10	R150-10	Nichifu NOP 700 & NOH300K	TIC 150
4175	200 (400MCM)		M10	R200-10	Nichifu NOP 700 & NOH300K	TIC 200
4215	250 (500MCM)		M10	R250-10	Nichifu NOP 700 & NOH300K	TIC 250
4270	300 (600MCM)		M12	R325-12S	Nichifu NOP 700 & NOH300K	TIC 325
4300	250 (500MCM) * 2		M12	R250-12	Nichifu NOP 700 & NOH300K	TIC 250
4375	250 (500MCM) * 2		M12	R250-12	Nichifu NOP 700 & NOH300K	TIC 250
4425	250 (500MCM) * 2		M12	R250-12	Nichifu NOP 700 & NOH300K	TIC 250
5001	2 (14) / 3.5 (12) / 5.3 (10)		M4	R2-4 ~ R5.5-4	Nichifu NH 1 / 9	TIC 2/ 3.5/ 5.5
5002	2 (14) / 3.5 (12) / 5.3 (10)		M4	R2-4 ~ R5.5-4	Nichifu NH 1 / 9	TIC 2/ 3.5/ 5.5
5003	2 (14) / 3.5 (12) / 5.3 (10)		M4	R2-4 ~ R5.5-4	Nichifu NH 1 / 9	TIC 2/ 3.5/ 5.5
5005	2 (14) / 3.5 (12) / 5.3 (10)		M6	R2-6 ~ R5.5-6	Nichifu NH 1 / 9	TIC 2/ 3.5/ 5.5
5008	3.5 (12) / 5.3 (10)		M6	R3.5-6 / R5.5-6	Nichifu NH 1 / 9	TIC 3.5/ 5.5

Drive Model A510s	Wire Gauge mm <sup>2</sup> , (AWG / MCM)		Terminal	Crimp Terminal	Tool	Insulation Cap
	R/L1 • S/L2 • T/L3	U/T1 • V/T2 • W/T3	Screws	Model No.	Machine No.	Model No.
5010	3.5 (12) / 5.3 (10)		M6	R3.5-6 / R5.5-6	Nichifu NH 1 / 9	TIC 3.5/ 5.5
6015	5.3 (10)		M6	R5.5-6	Nichifu NH 1 / 9	TIC 5.5
6020	8.4 (8)		M6	R8-6	Nichifu NOP 60 ; NH 1 / 9	TIC 8
6025	8.4 (8)		M6	R8-6	Nichifu NOP 60 ; NH 1 / 9	TIC 8
6030	8.4 (8)		M6	R8-6	Nichifu NOP 60 ; NH 1 / 9	TIC 8
6040	8.4 (8)		M6	R8-6	Nichifu NOP 60 ; NH 1 / 9	TIC 8
6050	13.3 (6)		M8	R14-8	Nichifu NOP 60 / 150HA	TIC 14
6060	13.3 (6)		M8	R14-8	Nichifu NOP 60 / 150HA	TIC 14
6075	21.2 (4)		M8	R22-8	Nichifu NOP 60 / 150HA	TIC 22
6100	33.6 (2)		M10	R38-10	Nichifu NOP 60 / 150HA	TIC 38
6125	67.4 (2/0)		M10	R70-10	Nichifu NOP 60 / 150HA	TIC 70
6150	67.4 (2/0)		M10	R70-10	Nichifu NOP 60 / 150HA	TIC 70
6175	85 (3/0)		M10	R80-10	Nichifu NOP 60 / 150HA	TIC 80
6215	152 (300MCM)		M10	R150-10	Nichifu NOP 700 & NOH300K	TIC 150
6250	152 (300MCM)		M10	R150-10	Nichifu NOP 700 & NOH300K	TIC 150
6270	152 (300MCM)		M10	R150-10	Nichifu NOP 700 & NOH300K	TIC 150

Drive Model A510s (F)	Wire Gauge mm <sup>2</sup> , (AWG / MCM)		Terminal	Crimp Terminal	Tool	Insulation Cap
	R/L1 • S/L2 • T/L3	U/T1 • V/T2 • W/T3	Screws	Model No.	Machine No.	Model No.
4001	2 (14) / 3.5 (12) / 5.3 (10)		M4	R2-4/R3.5-4/R5.5-4	Nichifu NH 1 / 9	TIC 2/ 3.5/ 5.5
4002	2 (14) / 3.5 (12) / 5.3 (10)		M4	R2-4/R3.5-4/R5.5-4	Nichifu NH 1 / 9	TIC 2/ 3.5/ 5.5
4003	2 (14) / 3.5 (12) / 5.3 (10)		M4	R2-4/R3.5-4/R5.5-4	Nichifu NH 1 / 9	TIC 2/ 3.5/ 5.5
4005	2 (14) / 3.5 (12) / 5.3 (10)		M4	R2-4/R3.5-4/R5.5-4	Nichifu NH 1 / 9	TIC 2/ 3.5/ 5.5
4008	5.3 (10)		M4	R5.5-4	Nichifu NH 1 / 9	TIC 5.5
4010	5.3 (10)		M6	R5.5-6	Nichifu NOP 60 ; NH 1 / 9	TIC 5.5
4015	8.4 (8)		M6	R8-6	Nichifu NOP 60 ; NH 1 / 9	TIC 8
4020	8.4 (8)		M6	R8-6	Nichifu NOP 60 ; NH 1 / 9	TIC 8
4025	8.4 (8)		M6	R8-6	Nichifu NOP 60 ; NH 1 / 9	TIC 8
4030	13.3 (6)		M6	R14-6	Nichifu NOP 60 / 150HA	TIC 14
4040-B	21.2 (4)		M6	R22-6	Nichifu NOP 60 / 150HA	TIC 22
4040	21.2 (4)		M8	R22-8	Nichifu NOP 60 / 150HA	TIC 22
4050	21.2 (4)		M8	R22-8	Nichifu NOP 60 / 150HA	TIC 22
4060	33.6 (2)		M8	R38-8	Nichifu NOP 60 / 150HA	TIC 38



### 3.7 Wiring Peripheral Power Devices

 **Caution**

- After power is shut off to the inverter the capacitors will slowly discharge. Do NOT touch the inverter circuit or replace any components until the “CHARGE” indicator is off.
- Do NOT wire or connect/disconnect internal connectors of the inverter when the inverter is powered up or after power off but the “CHARGE” indicator is on.
- Do NOT connect inverter output U, V and W to the AC power source. This will result in damage to the inverter.
- The inverter must be properly grounded. Use terminal E to connect earth ground and comply with local standards.
- It is required to disconnect the ground wire in the control board if the inverter is not grounded.
- Do NOT perform a dielectric voltage withstand test (Megger) on the inverter this will result in inverter damage to the semiconductor components.
- Do NOT touch any of the components on the inverter control board to prevent damage to the inverter by static electricity.

**200V: 1HP~2HP/ 400V: 1HP~3HP**

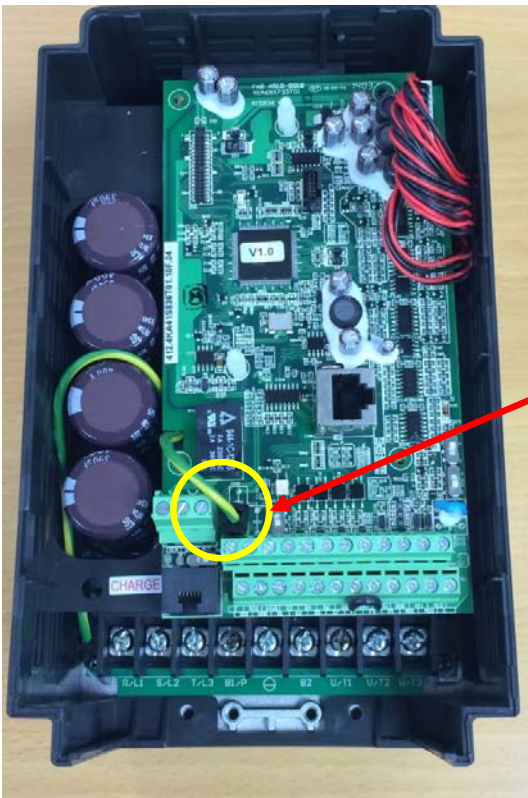

- **Disconnect the ground wire of J1. on the control board (C/B).**

200V: 3HP~8HP/ 400V: 5HP~8HP/575V: 1~3HP



- Disconnect the ground wire of J1 on the control board (C/B).

200V: 10HP/ 400V: 10~20HP/575V: 5~10HP

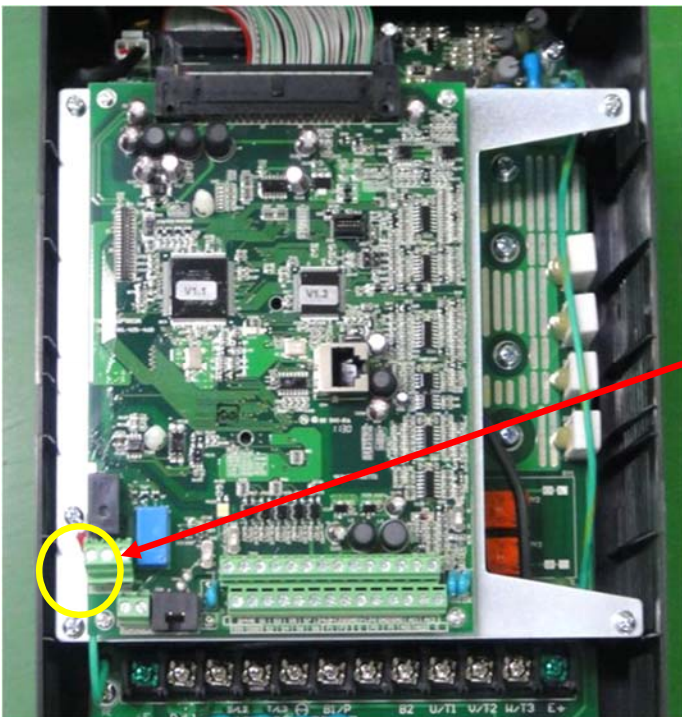

- Disconnect the ground wire of isolated metal plate.

200V: 15- 25HP/ 400V: 25~30HP/690V: 15~40HP

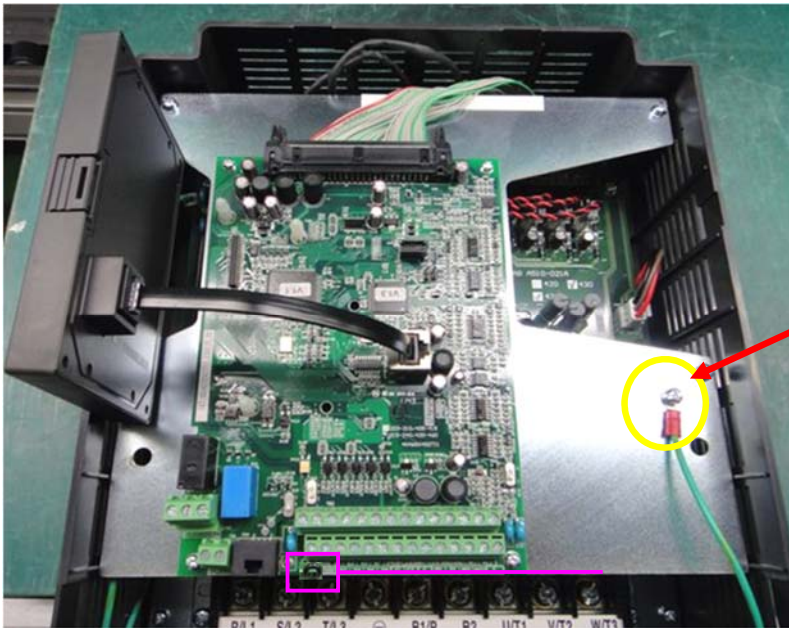

- Disconnect the ground wire of isolated metal plate.

200V: 30-40HP/ 400V: 40-75HP/690V: 50~75HP

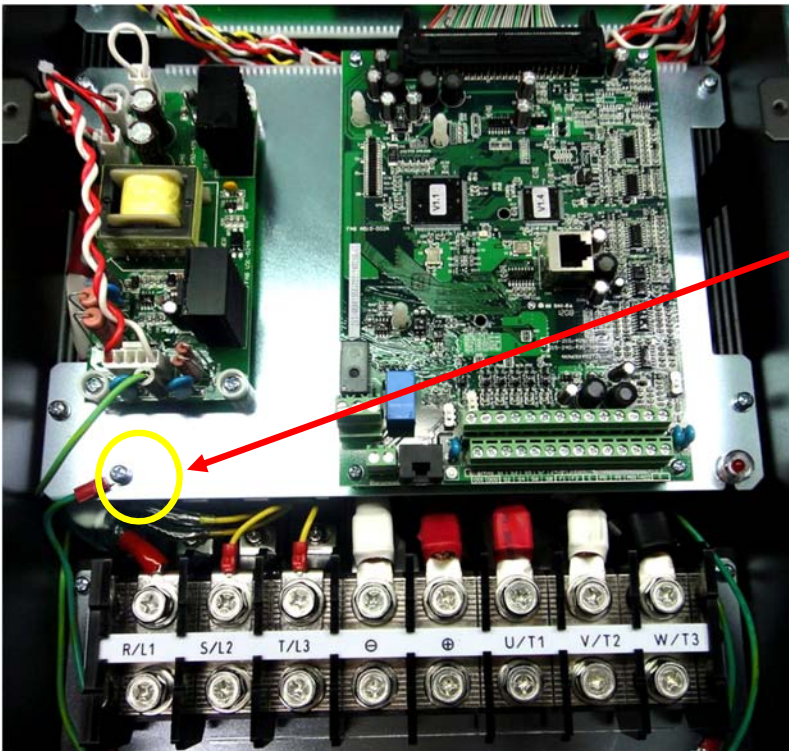

- Disconnect the ground wire of isolated metal plate.

200V: 50HP/ 400V: 100HP and the above/690V: 100HP

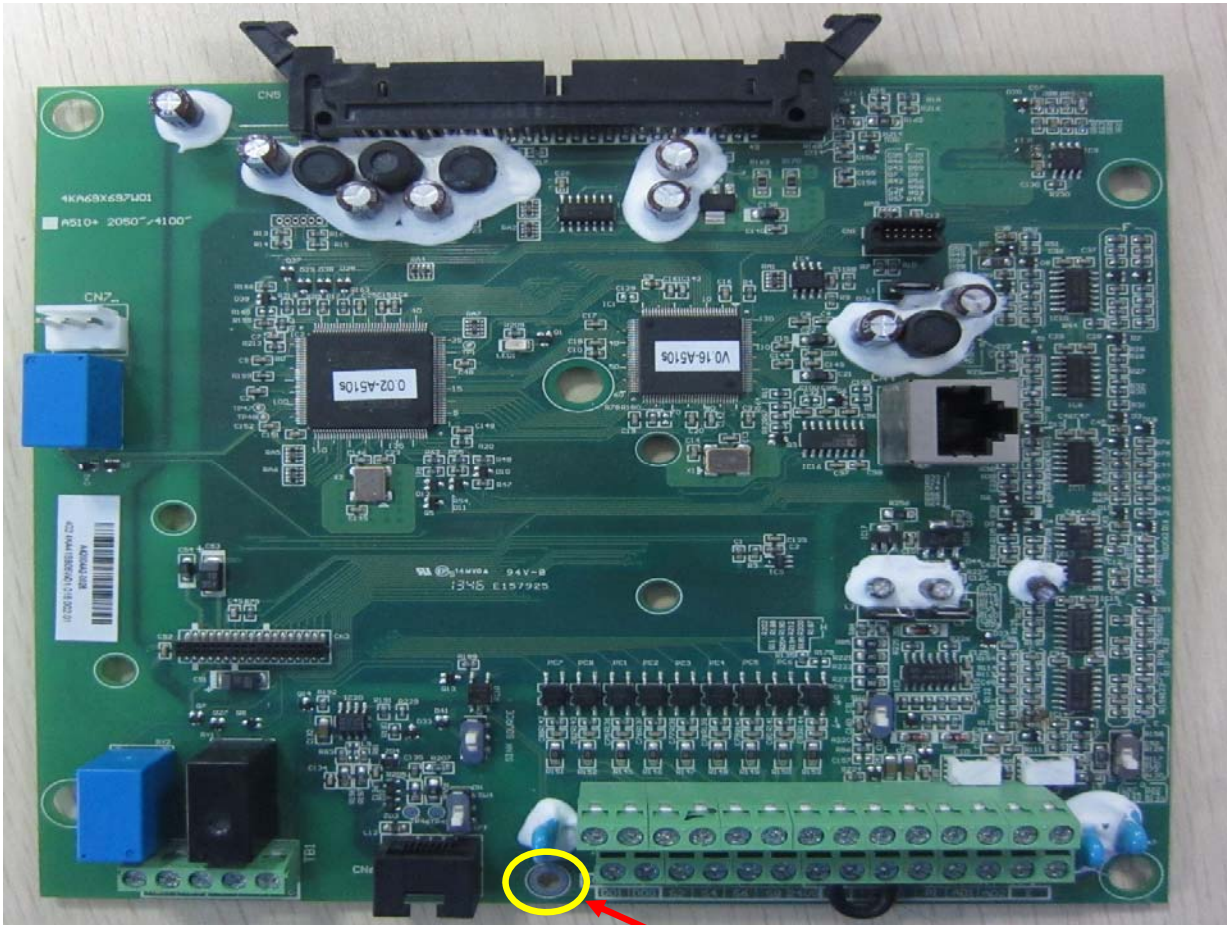

- Disconnect the ground screw below the C/B and ground studs of isolated metal plate.



#### Caution

- Refer to the recommended wire size table for the appropriate wire to use. The voltage between the power supply and the input terminals of the inverter may not exceed 2%.

**Phase-to-phase voltage drop (V) =  $\sqrt{3}$  × resistance of wire (Ω/km) × length of line (m) × current × 10<sup>-3</sup>.**

**(km=3280 × feet) / (m=3.28 × feet)**

- Reduce the carrier frequency (parameter 11-01) if the cable from the inverter to the motor is over 25m (82ft). A high-frequency current can be generated by stray capacitance between the cables and result in an overcurrent trip of the inverter, an increase in leakage current, or an inaccurate current readout.
- To protect peripheral equipment, install fast acting fuses on the input side of the inverter. Refer to section 11.4 for additional information.



Power Supply

**Power supply:**

-  Make sure the correct voltage is applied to avoid damaging the inverter.



Molded Circuit Breaker

**Molded-case circuit breaker (MCCB) or fused disconnect:**

- A molded-case circuit breaker or fused disconnect must be installed between the AC source and the inverter that conforms to the rated voltage and current of the inverter to control the power and protect the inverter.



Magnetic Contactor

-  Do not use the circuit breaker as the run/stop switch for the inverter.

**Ground fault detector / breaker:**

-  Install a ground fault breaker to prevent problems caused by current leakage and to protect personnel. Select current range up to 200mA, and action time up to 0.1 second to prevent high frequency failure.

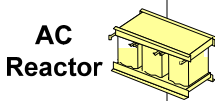

AC Reactor

**Magnetic contactor:**

- Normal operations do not need a magnetic contactor. When performing functions such as external control and auto restart after power failure, or when using a brake controller, install a magnetic contactor.



Fast Acting Fuse

-  Do not use the magnetic contactor as the run/stop switch for the inverter.

**AC line reactor for power quality:**

- When inverters are supplied by a high capacity power source (> 600KVA), an AC reactor can be connected to improve the power factor.



Input Noise Filter

**Install Fast Acting Fuse:**

- To protect peripheral equipment, install fast acting fuses in accordance with the specifications in section 11.4 for peripheral devices.



A510 Inverter

**Input Noise filter:**

- A filter must be installed when there are inductive loads affecting the inverter. The inverter meets EN55011 Class A, category C3 when the TECO special filter is used. See section 11.3 for peripheral devices.

Ground

**Inverter:**

- Output terminals T1, T2, and T3 are connected to U, V, and W terminals of the motor. If the motor runs in reverse while the inverter is set to run forward, swap any two terminals connections for T1, T2, and T3.



Output Noise Filter

-  To avoid damaging the inverter, do not connect the output terminals T1, T2, and T3 to AC input power.

-  Connect the ground terminal properly. (200V class: Rg <100Ω; 400V class: Rg <10Ω.)

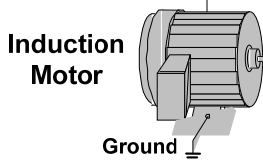

Induction Motor

**Output Noise filter:**

- An output noise filter may reduce system interference and induced noise.

Ground

**Motor:**

- If the inverter drives multiple motors the output rated current of the inverter must be greater than the total current of all the motors.

### 3.8.1 General Wiring Diagram (For Standard H & C type)

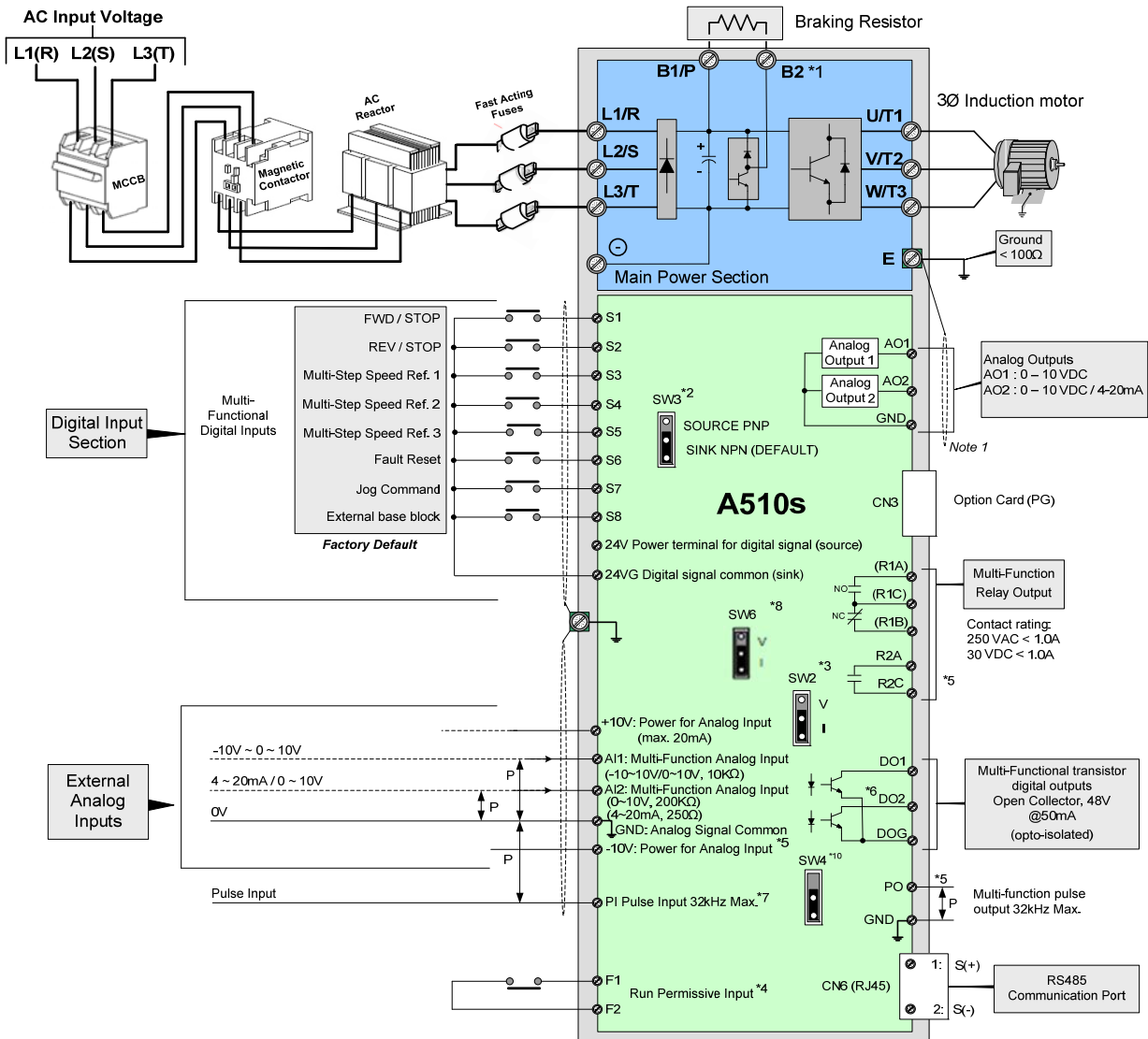

**Notes:**

- \*1: Models 200V 1 ~ 25HP and 400V 1 ~ 40HP or lower ratings have a built-in braking transistor. To use this braking transistor a braking resistor can be connected between B1 and B2.
- \*2: Use SW3 to select between Sink (NPN, with 24VG common) or Source (PNP, with +24V common) for multi-function digital input terminals S1~S8.
- \*3: Use SW2 to switch between voltage (0~10V) and current (4~20mA) input for Multi-function analog input 2 (AI2). Besides please also check parameter 04-00 for proper setting.
- \*4: Run Permissive input F1 and F2 is a normally closed input. This input should be closed to enable the inverter output. To activate this input remove the jumper wire between F1 and F2.
- \*5: Models 200V 3HP and 400V 5HP and higher ratings include terminals -10V, S(+), S(-), R2A-R2C and PO-GND.
- \*6: 200V 2HP and 400V 3HP and lower ratings include terminal DO2.
- \*7: When using the open collector for pulse input, it doesn't need resistance because of built-in pull-up resistance.
- \*8: AO2 default setting is 0~+10V.
- \*9: Both 200V class 50HP~150HP and 400V class 100HP~425HP have built-in DC reactors.
- \*10: It need turn on the switch for the terminal resistor RS485 in the last inverter when many inverters in parallel connection.

Please refer to Appendix A

### 3.8.2 General Wiring Diagram (For Enhanced E & G type)

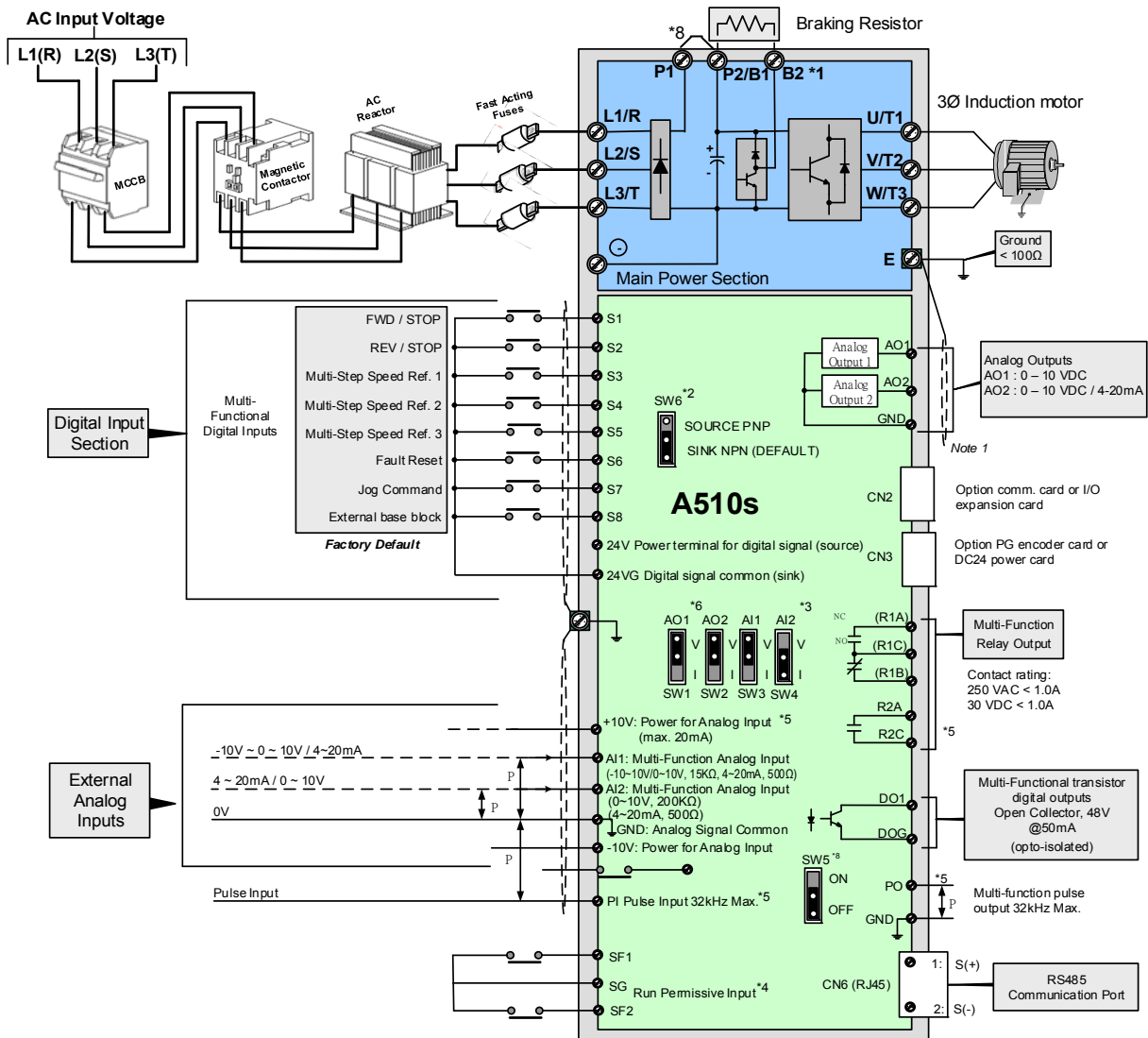

**Notes:**

- \*1: Models 200V 1 ~ 25HP and 400V 1 ~ 30HP or lower ratings have a built-in braking transistor. To use this braking transistor a braking resistor can be connected between B1 and B2.
- \*2: Use SW6 to select between Sink (NPN, with 24VG common) or Source (PNP, with +24V common) for multi-function digital input terminals S1~S8.
- \*3: Use SW3/SW4 to switch between voltage (0~10V) and current (4~20mA) input for Multi-function analog input 2 (AI2). Besides please also check parameter 04-00 for proper setting.
- \*4: Run Permissive input SF1 and SF2 is a normally closed input. This input should be closed to enable the inverter output. To activate this input remove the jumper wire between SF1/ SF2 and SG.
- \*5: When using the open collector for pulse input, it doesn't need resistance because of built-in pull-up resistance.
- \*6: AO1/AO2 default setting is 0~+10V.
- \*7: Both 200V class 50HP~150HP and 400V class 100HP~425HP have built-in DC reactors.
- \*8: Only the model 200V 3~40HP and 400V 5~75HP provide P1 terminal, for external DCL connected between P1 and P2, P1 and P2 are short-circuited before shipping out from the factory.
- \*9: It need turn on the switch for the terminal resistor RS485 in the last inverter when many inverters in parallel connection.

### 3.9.1 User (Control) Terminals (For Standard H & C type)

200V: 1 ~ 2 HP, 400V: 1 ~ 3HP

R1A	R1B	R1C	E	DO2	24VG	S2	S4	S6	S8	24V	+10V	GND	AI1	AI2
	RJ45		DO1	DOG	S1	S3	S5	S7	F1	F2	PI	AO1	AO2	E

200V: 3 ~ 40 HP, 400V: 5 ~ 75HP, 575V:1~10HP, 690V: 15~75HP

S(+)	S(-)	S1	S3	S5	S7	24V	+10V	GND	-10V	GND	GND	AI1	AI2
DO1	DOG	S2	S4	S6	S8	24VG	F1	F2	PO	PI	AO1	AO2	E

R1A	R1B	R1C
R2A	R2C	RJ45

200V: 50 ~ 150 HP, 400V: 100 ~ 425HP, 690V: 100~270HP

S(+)	S(-)	S1	S3	S5	S7	24V	+10V	GND	-10V	GND	GND	AI1	AI2
DO1	DOG	S2	S4	S6	S8	24VG	F1	F2	PO	PI	AO1	AO2	E

R2A	R2C	R1A	R1B	R1C
RJ45				



## Description of User Terminals

Type	Terminal	Terminal Function	Signal Level / Information
Digital input signal	<b>S1</b>	2-wire forward/ stop (default) * 1	Signal Level 24 VDC (photo isolated) Maximum current: 8mA Maximum voltage: 30 Vdc Input impedance: 4.22kΩ
	<b>S2</b>	2-wire reversal/ stop (default) * 1	
	<b>S3</b>	Multi-speed/ position setting command 1 (default) * 1	
	<b>S4</b>	Multi-speed/ position setting command 2 (default) * 1	
	<b>S5</b>	Multi-speed/ position setting command 3 (default) * 1	
	<b>S6</b>	Fault reset (default) * 1	
	<b>S7</b>	JOG frequency command (default) * 1	
	<b>S8</b>	External B.B.(Base Block) stop (coast to stop) (default) * 1	
24V Power supply	<b>24V</b>	Digital signal SOURCE point (SW3 switched to SOURCE )	±15%, Max. output current: 250mA (The sum of all loads connected )
	<b>24VG</b>	Common terminal of Digital signals Common point of digital signal SINK ( SW3 switched to SINK )	
Analog input signal	<b>+10V</b>	Power for external speed potentiometer	+10V (Max. current , 20mA)
	<b>-10V</b>	Only above 200V 3HP/ 400V 5HP (include) support this terminal function	-10V (Max. current , 20mA)
	<b>AI1</b>	Multi-function analog input for speed reference (0-10V input)/(-10V~10V input)	From 0 to +10V, From -10V to +10V Input impedance : 20KΩ Resolution: 11bit + 1
	<b>AI2</b>	Multi-function analog input terminals *2, can use SW2 to switch voltage or current input (0~10V)/(4-20mA)	From 0 to +10V, Input impedance: 200KΩ From 4 to 20 mA Input impedance: 250KΩ Resolution: 11bit + 1
	<b>GND</b>	Analog signal ground terminal	----
	<b>E</b>	Shielding wire's connecting terminal (Ground)	----
Analog output signal	<b>AO1</b>	Multi-function analog output terminals *2 (0~10V output)	From 0 to 10V, From 4 to 20mA (Load < 500Ω) PWM Frequency: 10KHz
	<b>AO2</b>	Multi-function analog output terminals *2. can use SW6 to switch voltage or current input (0~10V / 4-20mA output)	
	<b>GND</b>	Analog signals ground terminal	
Pulse output signal	<b>PO</b>	Pulse output, Band width 32KHz, only above 200V 3HP/ 400V 5HP (include) support this terminal function.	Max. Frequency: 32KHz Open Collector output
	<b>GND</b>	Analog signals ground terminal	----

Type	Terminal	Terminal Function	Signal Level / Information
Pulse input signal	<b>PI</b>	Pulse command input, Bandwidth: 32KHz	L: from 0.0 to 0.5V H: from 4.0 to 13.2V Max. Frequency: 0 - 32KHz Built-in pull-up resistance. When open collector input is used, it is not required to connect resistance.
	<b>GND</b>	Analog signals ground terminal	----
Digital output	<b>DO1</b>	Multi-function(open collector transistor) output *1	48Vdc, 2mA ~50mA Open-collector output
	<b>DO2</b> 200V:1-2HP 400V:1-3HP		
	<b>DOG</b>	Open collector transistor digital ground	
Relay output	<b>R1A</b>	Relay A contact (multi-function output terminal)	Rating: 250Vac, 10 mA ~ 1A 30Vdc, 10 mA ~ 1A
	<b>R1B</b>		
	<b>R1C</b>	Relay B contact (multi-function output terminal) Relay contact common terminal, With the same functions as DO1/DO2	
	<b>R2A-R2C</b> 200V:over 3HP 400V:over 5HP	With the same functions as DO1/DO2	
Run Permissive Input	<b>F1</b>	On: normal operation. Off: stop.	24Vdc, 8mA, pull-up
	<b>F2</b>	(Jumper wired between F1 and F2 has to be removed by using external contact to stop.)	24V Ground
RS-485 port	<b>S (+)</b>	RS485/ Modbus communication protocol	Differential input and output
	<b>S (-)</b>		
Grounding	<b>E (G)</b>	Grounding to earth Shield the connecting terminal	----

**Notes:**

\*1:Multi-function digital input/ output can be referred to in this manual.

- Group 03: External Terminals Digital Input / Output Function Group.

\*2:Multi-function analog input/ output can be referred to in this manual..

- Group 04 - External Terminal Analog Signal Input (Output) Function Group.

### 3.9.2 User (Control) Terminals (For Enhanced E & G type)

200V: 1 ~ 2 HP, 400V: 1 ~ 3HP

R1A	R1B	R1C	R2A	R2C	S(+)	S(-)	S1	S3	S5	S7	24V	24VG	+10V	-10V	GND	GND	AI1	AI2
RJ45					DO1	DOG	S2	S4	S6	S8	SF1	SG	SF2	PO	PI	AO1	AO2	E

200V: 3 ~ 40 HP, 400V: 5 ~ 75HP

R1A	R1B	R1C	S(+)	S(-)	S1	S3	S5	S7	24V	24VG	+10V	-10V	GND	GND	AI1	AI2
R2A	R2C	RJ45	DO1	DOG	S2	S4	S6	S8	SF1	SG	SF2	PO	PI	AO1	AO2	E

200V: 50 ~ 150 HP, 400V: 100 ~ 425HP

R2A	R2C	R1A	R1B	R1C	RJ45	S(+)	S(-)	S1	S3	S5	S7	24V	24VG	+10V	-10V	GND	GND	AI1	AI2
						DO1	DOG	S2	S4	S6	S8	SF1	SG	SF2	PO	PI	AO1	AO2	E

#### Description of User Terminals

Type	Terminal	Terminal Function	Signal Level / Information
Digital input signal	S1	2-wire forward/ stop (default) *1	Signal Level 24 VDC (photo isolated) Maximum current: 8mA Maximum voltage: 30 Vdc Input impedance: 4.22kΩ
	S2	2-wire reversal/ stop (default) *1	
	S3	Multi-speed/ position setting command 1 (default) *1	
	S4	Multi-speed/ position setting command 2 (default) *1	
	S5	Multi-speed/ position setting command 3 (default) *1	
	S6	Fault reset (default) *1	
	S7	JOG frequency command (default) *1	
24V Power supply	24V	Digital signal SOURCE point (SW6 switched to SOURCE )	±15%, Max. output current: 250mA (The sum of all loads connected )
	24VG	Common terminal of Digital signals Common point of digital signal SINK ( SW6 switched to SINK )	
Analog input signal	+10V	Positive power for external speed potentiometer	+10V (Max. current , 20mA)
	-10V	Negative power for external speed potentiometer	-10V (Max. current , 20mA)
	AI1	Multi-function analog input terminals *2, can use SW3 to switch voltage or current input (-10V~10V)/(4-20mA)	From 0 to +10V, From -10V to +10V Input impedance : 500KΩ From 4 to 20 mA Input impedance : 500KΩ Resolution: 11bit + 1
	AI2	Multi-function analog input terminals *2, can use SW4 to switch voltage or current input (0~10V)/(4-20mA)	From 0 to +10V, Input impedance: 900KΩ From 4 to 20 mA Input impedance: 250Ω Resolution: 11bit + 1
	GND	Analog signal ground terminal	----
	E	Shielding wire's connecting terminal (Ground)	----
Analog output signal	AO1	Multi-function analog output terminals *2. can use SW1 to switch voltage or current input (0~10V / 4-20mA output)	From 0 to 10V, From 4 to 20mA (Load < 500Ω)

Type	Terminal	Terminal Function	Signal Level / Information
	<b>AO2</b>	Multi-function analog output terminals *2. can use SW2 to switch voltage or current input (0~10V / 4-20mA output)	PWM Frequency: 10KHz
	<b>GND</b>	Analog signals ground terminal	
Pulse output signal	<b>PO</b>	Bandwidth: 32KHz	Max. Frequency: 32KHz Open Collector output
	<b>GND</b>	Analog signals ground terminal	----
Pulse input signal	<b>PI</b>	Pulse command input, Bandwidth: 32KHz	L: from 0.0 to 0.5V H: from 4.0 to 13.2V Max. Frequency: 0 - 32KHz Built-in pull-up resistance. When open collector input is used, it is not required to connect resistance.
	<b>GND</b>	Analog signals ground terminal	----
Digital output	<b>DO1</b>	Multi-function(open collector transistor) output *1	48Vdc, 2mA ~50mA Open-collector output
	<b>DOG</b>	Open collector transistor digital ground	
Relay output	<b>R1A</b>	Relay A contact (multi-function output terminal) Relay B contact (multi-function output terminal) Relay contact common terminal, With the same functions as DO1	Rating: 250Vac, 10 mA ~ 1A 30Vdc, 10 mA ~ 1A
	<b>R1B</b>		
	<b>R1C</b>		
	<b>R2A-R2C</b>	Relay A contact (multi-function output terminal) Relay B contact (multi-function output terminal) Relay contact common terminal, With the same functions as DO1	Rating: 250Vac, 10 mA ~ 1A 30Vdc, 10 mA ~ 1A
Run Permissive Input	<b>SF1</b> <b>SF2</b>	On: normal operation. Off: stop. (Jumper wired between SF1/ SF2 and SG has to be removed by using external contact to stop.)	24Vdc, 8mA, pull-up
	<b>SG</b>	Safety command common terminal	
	RS-485 port	<b>S (+)</b> <b>S (-)</b>	RS485/ Modbus communication protocol
Grounding	<b>E (G)</b>	Grounding to earth Shield the connecting terminal	----

**Notes:**

\*1:Multi-function digital input/ output can be referred to in our instruction manual.

- Group 03: External Terminals Digital Input / Output Function Group.

\*2:Multi-function analog input/ output can be referred to in our instruction manual..

- Group 04 - External Terminal Analog Signal Input (Output) Function Group.

 <b>Caution</b>
<ul style="list-style-type: none"> <li>• Maximum output current capacity for terminal 10V is 20mA.</li> <li>• Multi-function analog output AO1 and AO2 are used for an analog output meter. Do not use these outputs for feedback control.</li> <li>• Control board's 24V and ±10V are to be used for internal control only, Do not use the internal power-supply to power external devices.</li> </ul>

### 3.10.1 Power Terminals (For Standard H & C type)

Terminal	200V: 1 ~ 25HP 400V: 1 ~ 40HP 575V: 1 ~ 10HP 690V: 15 ~ 40HP	200V: 30 ~ 150HP 400V: 50 ~ 425HP 690V: 50 ~ 270HP
	R/L1 S/L2 T/L3	Input Power Supply (For single phase use terminals R/L1 and S/L2)
B1 / P B2 ⊖ ⊕	B1 / P—B2: external braking resistor	- ⊕ -⊖: Connect braking module
U/T1 V/T2 W/T3	Inverter output	
E/PE/⊖	Ground terminal	

Note: The power terminal of 575V & 690V Enhanced E & G type and Standard H & C type are the same. Please refer to this quarter for 575V & 690V Enhanced E & G type power terminal information.

200V: 1 ~ 2HP, 400V: 1 ~ 3HP

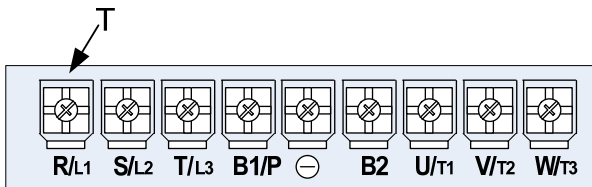

Terminal screw size	
T	⊖
M4	M4

200V: 3 ~ 7.5HP, 400V: 5 ~ 7.5HP, 575V: 1~3HP

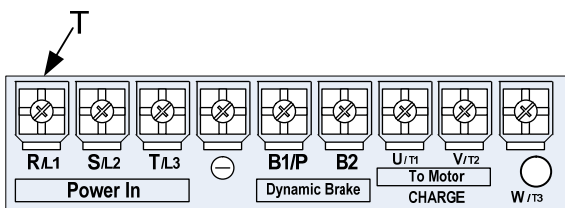

Terminal screw size	
T	⊖
M4	M4

200V: 10HP, 400V: 10 ~ 15HP

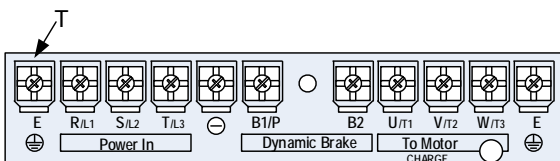

Terminal screw size	
T	⊖
M6	M6

575V: 5~10HP

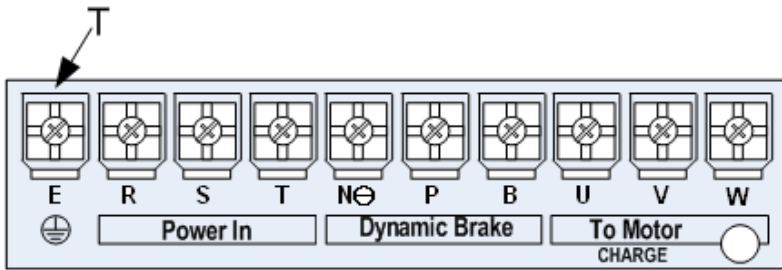

Terminal screw size	
T	⊕
M6	M6

400V: 20HP (Frame 3)

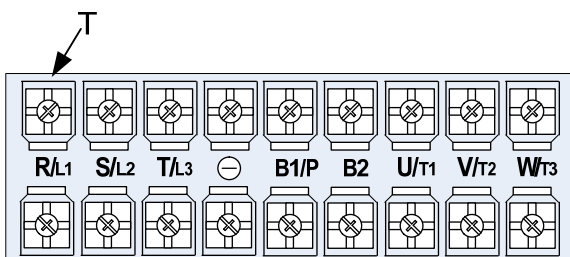

Terminal screw size	
T	⊕
M6	M5

200V: 15~25HP, 400V: 20 ~ 30HP, 690V: 15~40HP

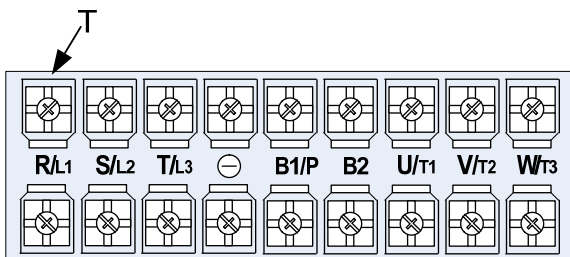

Terminal screw size	
T	⊕
M6	M6

400V: 40HP

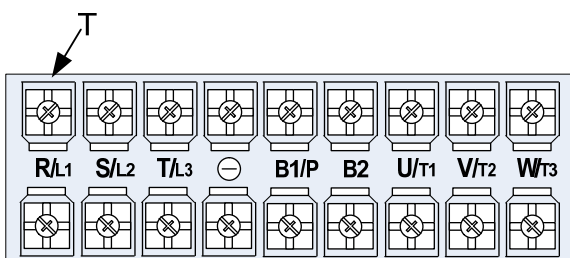

Terminal screw size	
T	⊕
M6	M8

200V: 30 ~40HP, 400V: 50 ~ 75HP

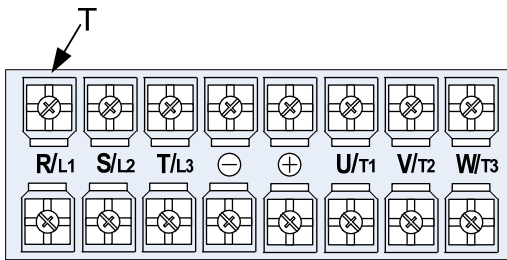

Terminal screw size	
T	⊕
M8	M8

690V: 50~75HP

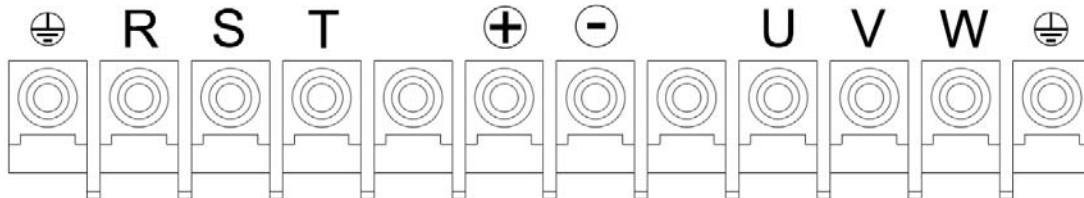

Terminal screw size	
T	⊕
M6	M6

200V: 50~60HP, 400V: 100HP

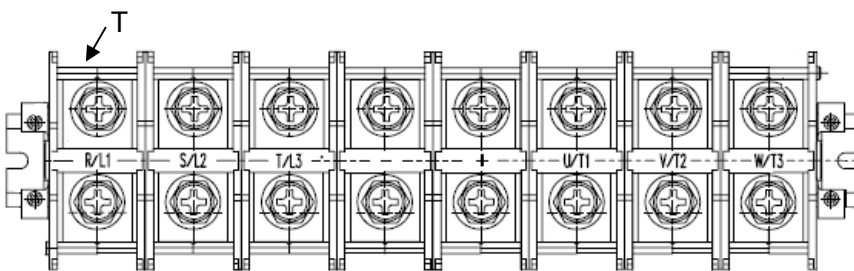

Terminal screw size		
Power supply	T	⊕
200V 50-60HP/ 400V 100HP	M10	M10

690V: 100~150HP

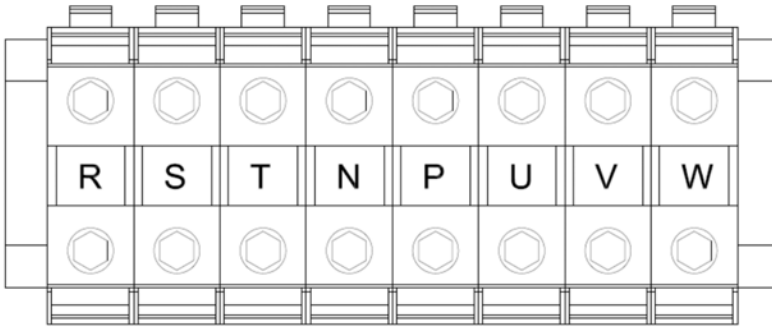

Power supply	⊕
690V 100~150HP	M10

400V : 125HP

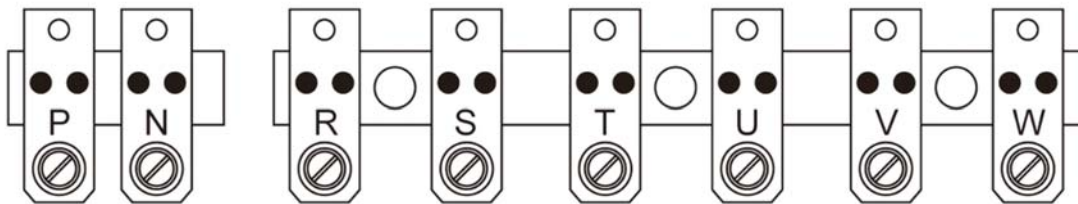

Terminal screw size	
T	⊕
M10	M10



200V: 75~100HP, 400V: 150~215HP, 690V: 175~270HP

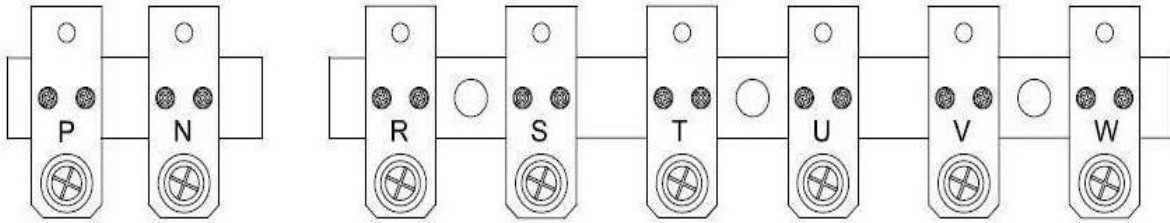

Terminal screw size	
T	⊕
M10	M10

200V: 125~150HP, 400V: 270~425HP

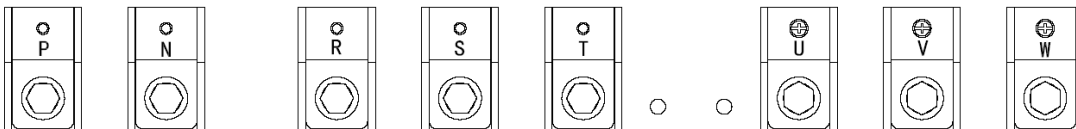

Terminal screw size	
T	⊕
M12	M10

Notes: For wire gauges and screw torques, please refer to the table in section 3.6.

### 3.10.2 Power Terminals (For Enhanced E & G type)

Terminal	200V: 1 ~ 2HP 400V: 1 ~ 3HP & 40HP-B	200V: 3 ~ 30HP 400V: 5 ~ 75HP	200V: 40 ~ 150HP 400V: 50 ~ 425HP
R/L1	Input Power Supply (For single phase use terminals R/L1 and S/L2)		
S/L2			
T/L3			
B1/P	B1/P—B2: external braking resistor B1/P—⊖: DC link	P2/B1—B2: external braking resistor P1—P2/B1: external DCL P1—⊖: DC link	⊕/P1—⊖/N: Connect braking module
P2/B1			
B2			
⊖			
N			
⊕			
P1			
U/T1	Inverter output		
V/T2			
W/T3			
E/PE/⊕	Ground terminal		

200V : 1 ~ 2HP , 400V : 1 ~ 3HP

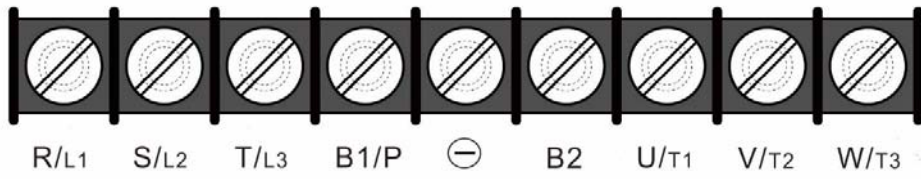

Terminal screw size	
T	
M4	M4

200V : 3 ~ 7.5HP , 400V : 5 ~ 7.5HP

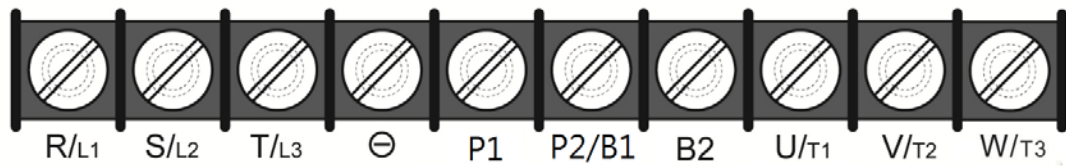

Terminal screw size	
T	
M4	M4

200V : 10HP , 400V : 10 ~ 20HP

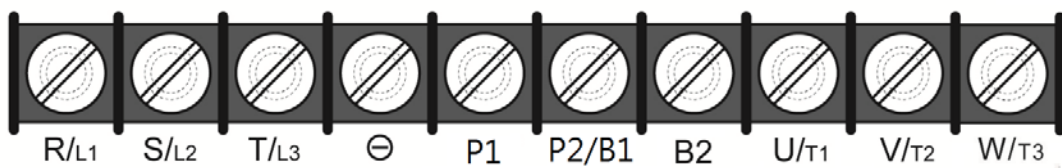

Terminal screw size	
T	
M6	M6

200V : 15~25HP , 400V : 25 ~ 30HP

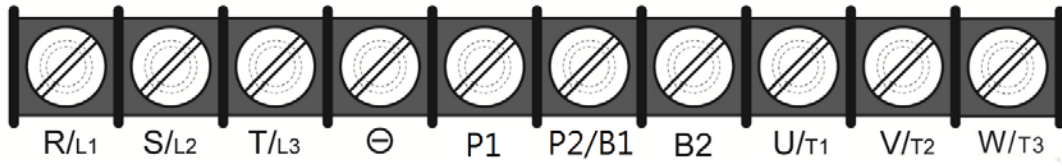

Terminal screw size	
T	
M6	M6

200V : 30 ~40HP , 400V : 40 ~ 75HP

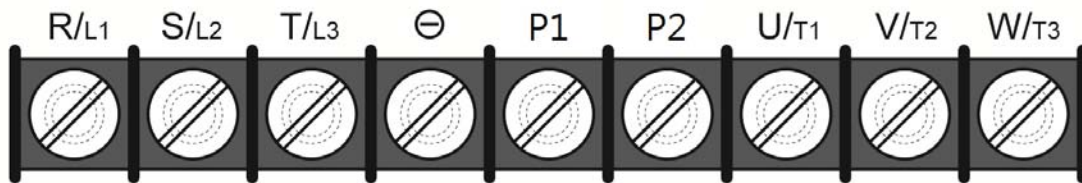

Terminal screw size	
T	
M8	M8

400V: 40HP-B

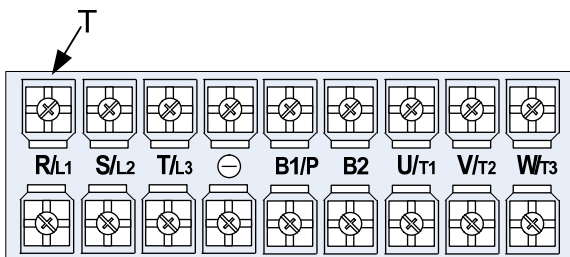

Terminal screw size	
T	
M6	M8

200V : 50~60HP, 400V : 100HP

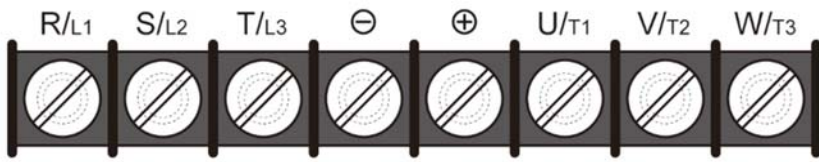

Terminal screw size	
T	
M10	M10

400V : 125HP

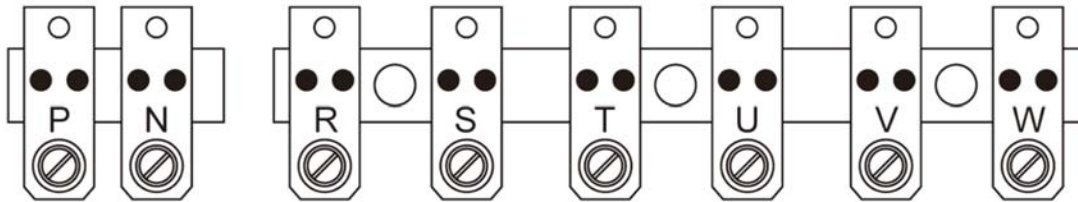

Terminal screw size	
T	
M10	M10

200V : 75~100HP, 400V : 150~215HP

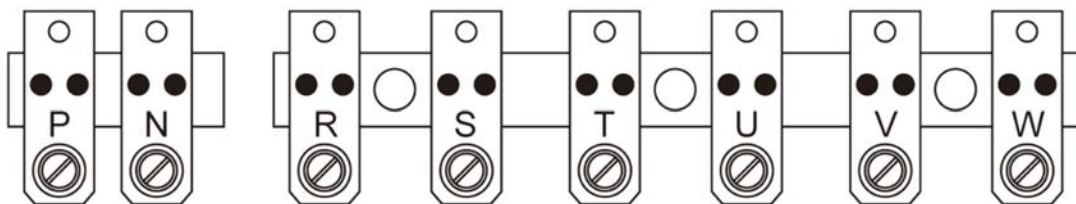

Terminal screw size	
T	
M10	M10

200V : 125~150HP, 400V : 270~425HP

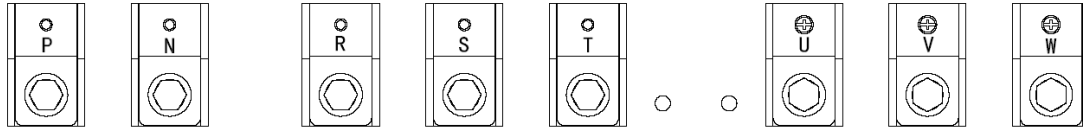

Terminal screw size	
T	
M12	M10

### 3.11 Input / Output Power Section Block Diagram

The following diagrams 1 - 8 show the basic configuration of the power sections for the range of horsepower and input voltages. This is shown for reference only and is not a detailed depiction. (For Enhanced E & G type frame 2~5, which can connect option DC reactor, please refer to General Wiring Diagram)

1-1: 200V: 1 HP / 400V: 1 ~ 2 HP (Standard type) / 400V: 1 HP (Enhanced type)

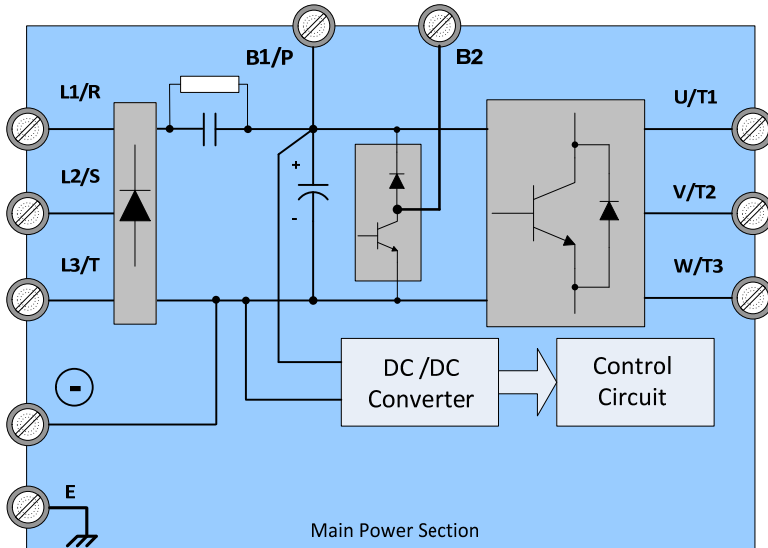

2-1: 200V: 2 ~ 25 HP (Standard Type) / 400V: 3 ~ 40 HP (Standard Type) / 40 HP-B (Enhanced Type) / 575V: 1~10HP / 690V: 15~40HP

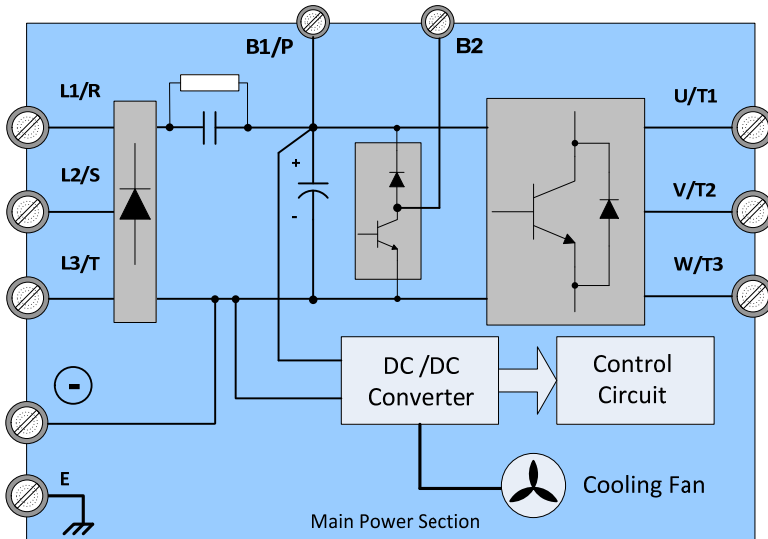

2-2: 200V: 2 HP (Enhanced Type) / 400V: 2 ~ 3 HP (Enhanced Type)

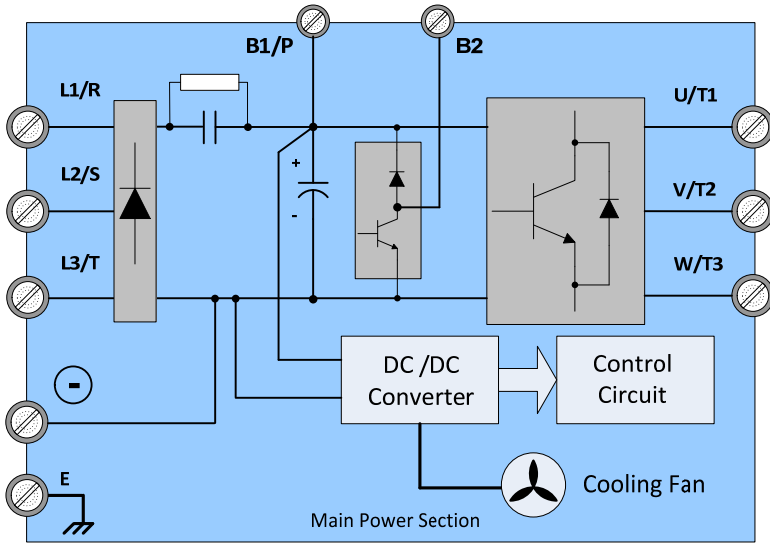

2-3: 200V: 3 ~ 25 HP (Enhanced Type) / 400V: 3 ~ 30 HP (Enhanced Type)

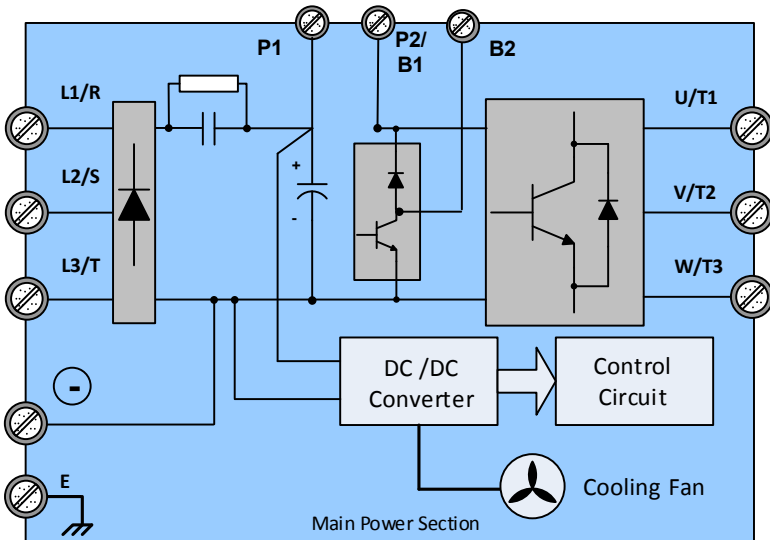

3-1: 200V: 30 ~ 40 HP (Standard Type) / 400V: 50 ~ 75 HP (Standard Type)

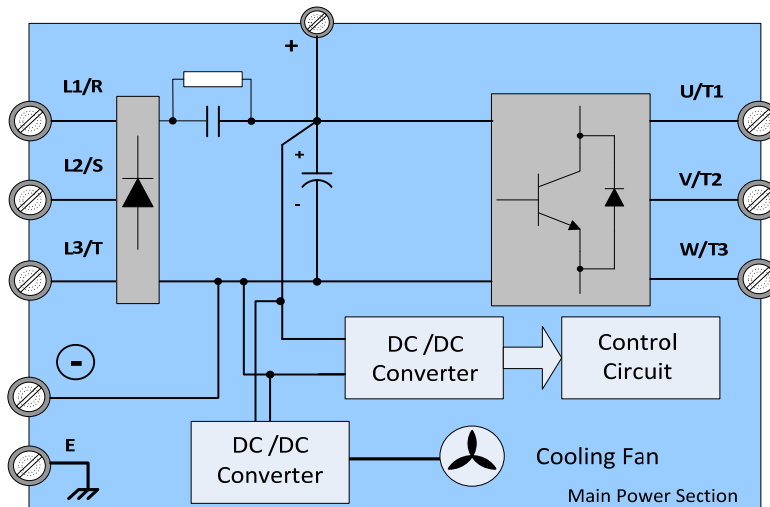

3-2: 200V: 30 ~ 40 HP (Enhanced Type) /400V: 40 ~ 75 HP (Enhanced Type)

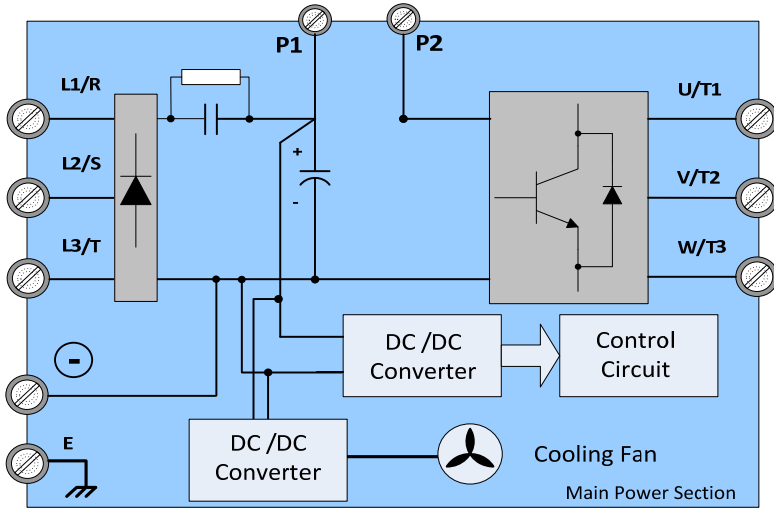

4: 690V: 50~75HP

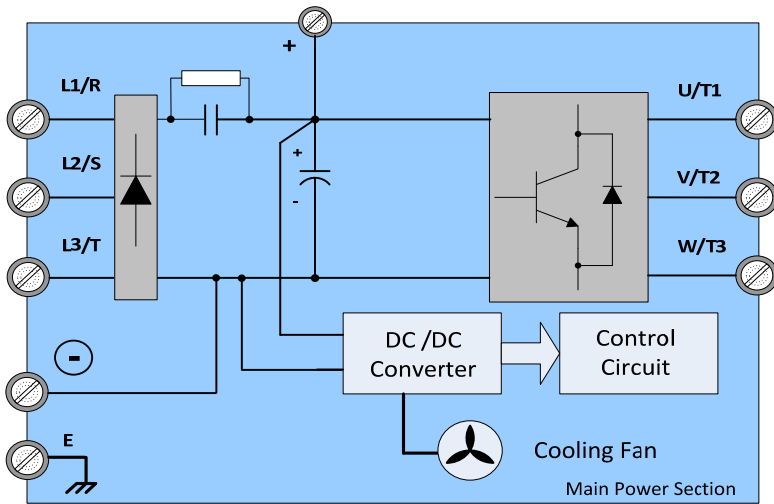

5: 200V: 50 ~ 60 HP / 400V: 100 ~ 215 HP

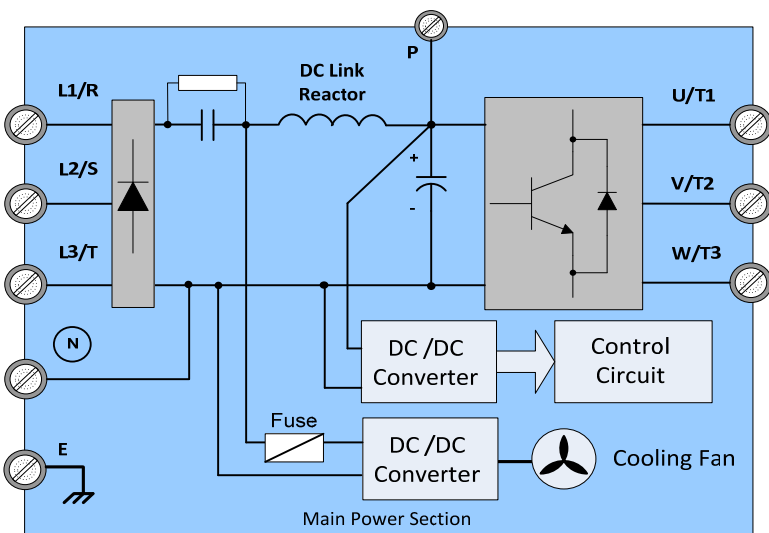



6: 690V: 100~150HP

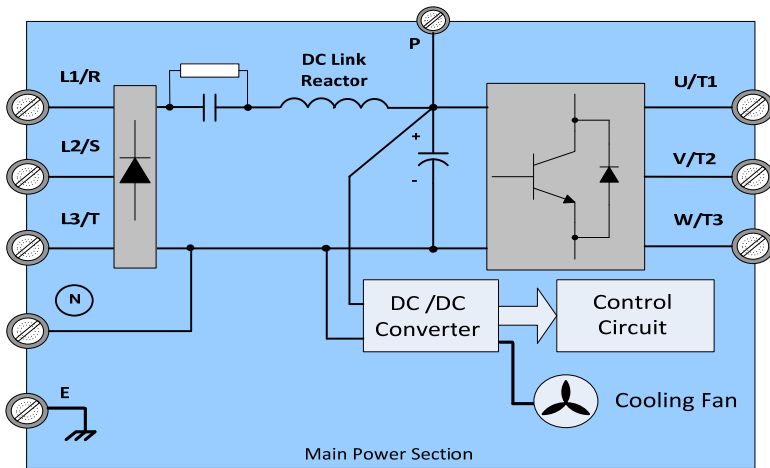

7: 200V: 75, 100 HP, 125, 150 HP

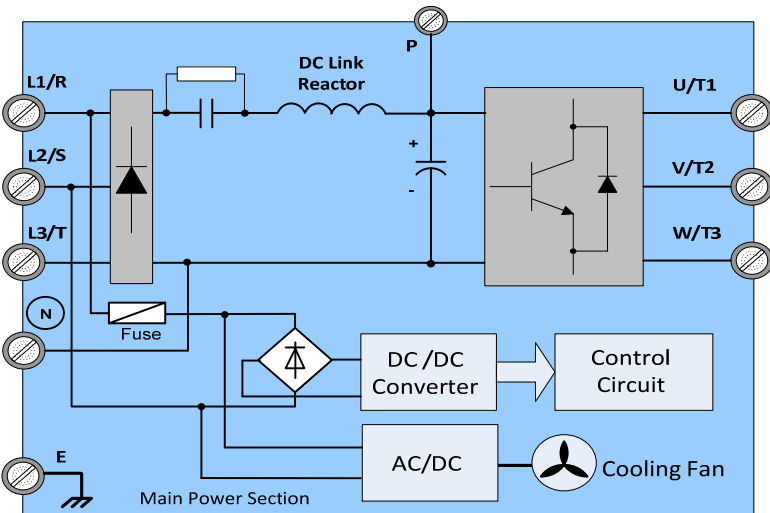

8: 400V: 270HP, 300HP, 375HP, 425 HP / 690V: 175~270HP

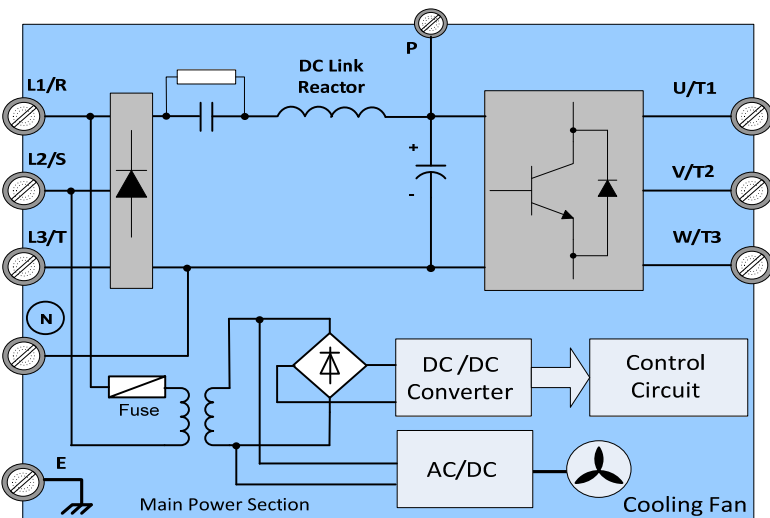

### 3.11.1 Cooling Fan Supply Voltage Selection (400V class)

The inverter input voltage range of the A510s 400V class models ranges from 380 to 480Vac. In these models the cooling fan is directly powered from the power supply. Inverter models A510s-4215(F8)/ 4270/ 4300/ 4375/ 4425 requires the user to select the correct jumper position based on the inverter input voltage ("400V" is the default position for these models). Please select the correct position according to the input voltage. If the voltage setting is too low, the cooling fan will not provide adequate cooling for the inverter resulting in an over-heat error. If the input voltage is greater than 460Vac, select the "460V" position.

(1) 400V: 270HP~425HP

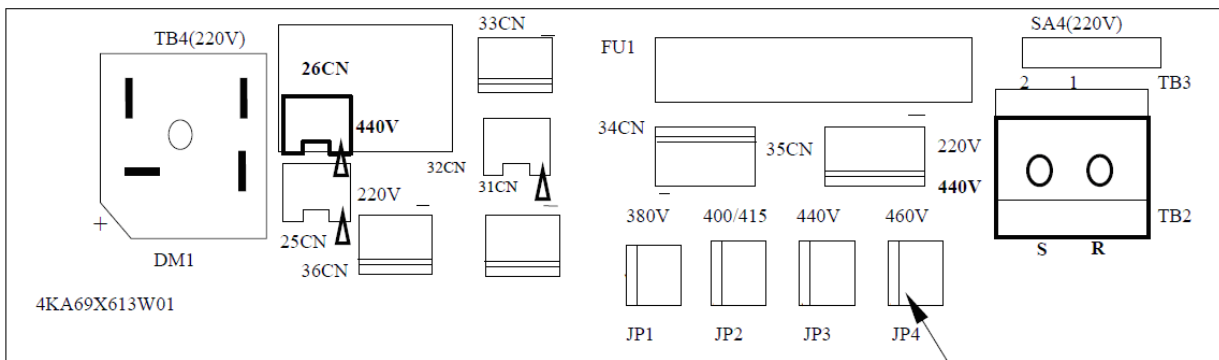

For example, input voltage is 460 Vac, jumper pin needs to put in "460V" position.

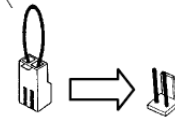

The inverter input voltage range of the A510s 600V class models ranges from 575 to 690Vac. In these models the cooling fan is directly powered from the power supply. Inverter models A510s-6175~6270 requires the user to select the correct jumper position based on the inverter input voltage ("690V" is the default position for these models). Please select the correct position according to the input voltage. If the voltage setting is too low, the cooling fan will not provide adequate cooling for the inverter resulting in an over-heat error. If the input voltage is greater than 690Vac, select the "690V" position.

(2) 690V: 175HP~270HP

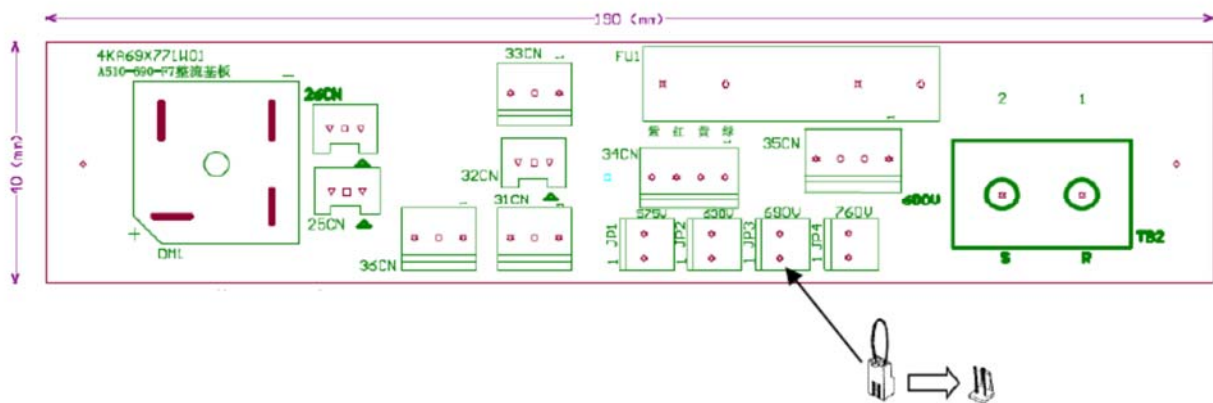

Input voltage range Vac	Voltage selection board position
510 ~ 600	575V
601 ~ 660	630V
661 ~ 720	690V
721 ~ 759	760V

## 3.12 Inverter Wiring

### Wiring Precautions

 <b>Danger</b>	<ul style="list-style-type: none"><li>• Do <b>NOT</b> remove any protective covers or attempt any wiring while input power is applied. Connect all wiring before applying input power. When making wiring changes after power up, remove input power and wait a minimum of five minutes after power has been turned off before starting. Also confirm that the charge lamp is off and that DC voltage between terminals B1/P or (+) and (-) does not exceed 25V, otherwise <b>electric shock may result</b>.</li><li>• Only authorized personnel should work on the equipment. (Take off metal jewelry such as watches and rings and use insulated tools.), otherwise <b>electric shock or injury may result</b>.</li></ul>
---	---

#### (A) Power input terminals

1. The Input power supply voltage can be connected in any phase sequence to power input terminals R/L1, S/L2, or T/L3 on the terminal block.
2. DO NOT connect the AC input power source to the output terminals U/T1, V/T2 and W/T3.
3. Connect the output terminals U/T1, V/T2, W/T3 to motor lead wires U/T1, V/T2, and W/T3, respectively.
4. Check that the motor rotates forward with the forward run source. If it does not, swap any 2 of the output cables to change motor direction.
5. DO NOT connect phase correcting capacitors or LC/RC noise filter to the output circuit.

#### (B) Grounding

1. Connect the ground terminal (E) to ground having a resistance of less than  $100\Omega$ .
2. Do not share the ground wire with other devices, such as welding machines or power tools.
3. Always use a ground wire that complies with the local codes and standards for electrical equipment and minimize the length of ground wire.
4. When using more than one inverter, be careful not to loop the ground wire, as shown below in Fig. 3.12.1.

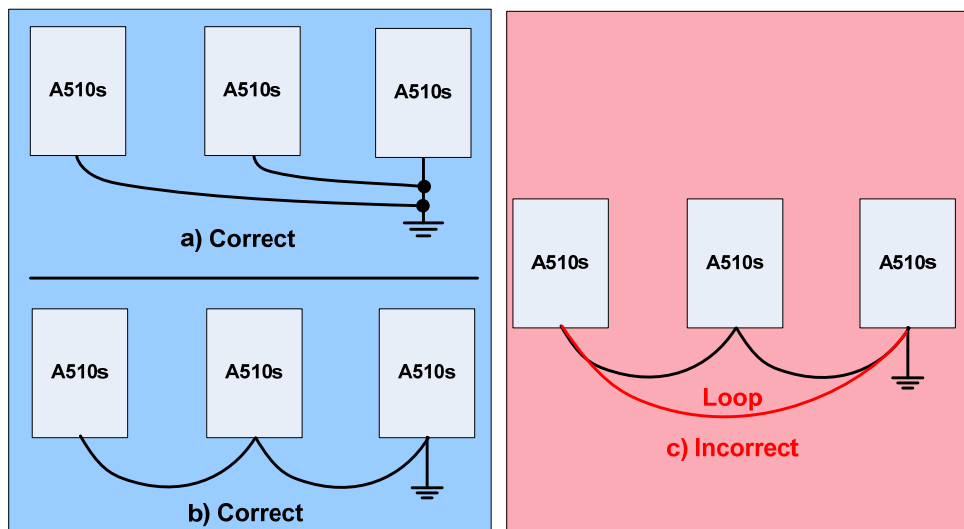

Fig. 3.12.1 Inverter Grounding

### 3.13 Input Power and Motor Cable Length

The length of the cables between the input power source and /or the motor and inverter can cause a significant phase to phase voltage reduction due to the voltage drop across the cables. The wire size shown in Tables 3.16.1 is based on a maximum voltage drop of 2%. If this value is exceeded, a wire size having larger diameter may be needed. To calculate phase to phase voltage drop, apply the following formula:

$$\text{Phase-to-phase voltage drop (V)} = \sqrt{3} \times \text{resistance of wire } (\Omega/\text{km}) \times \text{length of line (m)} \times \text{current (A)} \times 10^{-3}.$$

(km=3280 x feet)

(m=3.28 x feet)

### 3.14 Cable Length vs. Carrier Frequency

The allowable setting of the PWM carrier frequency is also determined by motor cable length and is specified in the following Table 3.14.1.

**Table 3.14.1 Cable Length vs. Carrier Frequency**

<b>Cable length between the inverter and Motor in m (ft.).</b>	< 30m (100)	30 – 50 (100 – 165)	50 – 100 (166 - 328)	≥ 100 (329)
<b>Recommended carrier frequency allowed Parameter 11-01</b>	16kHz (max)	10 kHz (max)	5 kHz (max)	2 kHz (max)

### 3.15 Installing an AC Line Reactor

If the inverter is connected to a large-capacity power source (600kVA or more), install an optional AC reactor on the input side of the inverter. This also improves the power factor on the power supply side.

### 3.16 Power Input Wire Size, NFB and MCB Part Numbers

The following table shows the recommended wire size, molded case circuit breakers and magnetic contactors for each of the A510S models. It depends on the application whether or not to install a circuit breaker. The NFB must be installed between the input power supply and the inverter input (R/L1, S/L2, T/L3).

**Note:** When using a ground protection make sure the current setting is above 200mA and trip delay time is 0.1 sec of higher.

**Table 3.16.1 Wiring instrument for 200V/400V class**

Power	A510s Model			wire diameter AWG(mm <sup>2</sup> )			NFB <sup>*4</sup>	MC <sup>*4</sup>
	horse power (HP) <sup>*1</sup>	Rated KVA HD/ND	Rated current (A) HD/ND	Main circuit <sup>*2</sup>	Grounding line E(G)	Control line <sup>*3</sup>		
200V 1 Ø / 3Ø	1HP	1.9/2.3	5/6	14~10 (2~5.3)	14~10 (2~5.3)	30~14 (0.5~2)	TO-50EC(15A)	CU-11
	2HP	3/3.7	8/9.6	14~10 (2~5.3)	11~10 (3.5~5.3)	30~14 (0.5~2)	TO-50EC(20A)	CU-11
	3HP	4.2/4.6	11/12	11~10 (3.5~5.3)	11~10 (3.5~5.3)	30~14 (0.5~2)	TO-50EC(30A)	CU-11
200V 3 Ø	5HP	6.7/8.4	17.5/22	10 (5.3)	10 (5.3)	30~14 (0.5~2)	TO-50EC(30A)	CU-16
	7.5HP	9.5/11.4	25/30	8 (8.4)	10~8 (5.3~8.4)	30~14 (0.5~2)	TO-100S(50A)	CU-18
	10HP	12.6/16.0	33/42	8 (8.4)	10~8 (5.3~8.4)	30~14 (0.5~2)	TO-100S(50A)	CU-25
	15HP	17.9/21.3	47/56	6 (13.3)	8 (8.4)	30~14 (0.5~2)	TO-100S(100A)	CU-50
	20HP	22.9/26.3	60/69	4 (21.2)	8 (8.4)	30~14 (0.5~2)	TO-100S(100A)	CU-65
	25HP	27.8/30.1	73/80	4 (21.2)	6 (13.3)	30~14 (0.5~2)	TO-225S(100A)	CU-80
	30HP	32.4/41.9	85/110	2 (33.6)	6 (13.3)	30~14 (0.5~2)	TO-225S(150A)	CN-100
	40HP	43.8/52.6	115/138	2/0 (67.4)	4 (21.2)	30~14 (0.5~2)	TO-225S(175A)	CN-125
	50HP	55.3/64.4	145/169	3/0 (85)	4 (21.2)	30~14 (0.5~2)	TO-225S(200A)	CN-150
	60HP	68.6/76.2	180/200	4/0 (107.2)	4 (21.2)	30~14 (0.5~2)	TO-225S(225A)	CN-180
	75HP	81.9/95.3	215/250	300 (152)	4 (21.2)	30~14 (0.5~2)	TO-400S(300A)	CN-300
	100HP	108/118.9	283/312	400 (200)	2 (33.62)	30~14 (0.5~2)	TO-400S(400A)	CN-300
	125HP	132/137.2	346/400	600 (300)	2 (33.62)	30~14 (0.5~2)	TO-400S(400A)	SK-400
150HP	158/172	415/450	500*2P (250*2P)	1/0 (50)	30~14 (0.5~2)	TO-800S(800A)	SK-600	
400V 3 Ø	1HP	2.6/3.1	3.4/4.1	14~10 (2~5.3)	14~10 (2~5.3)	30~14 (0.5~2)	TO-50EC(15A)	CU-11
	2HP	3.2/4.1	4.2/5.4	14~10 (2~5.5)	11~10 (3.5~5.3)	30~14 (0.5~2)	TO-50EC(15A)	CU-11

A510s Model				wire diameter AWG(mm <sup>2</sup> )			NFB* <sup>4</sup>	MC* <sup>4</sup>
Power	horse power (HP)* <sup>1</sup>	Rated KVA HD/ND	Rated current (A) HD/ND	Main circuit* <sup>2</sup>	Grounding line E(G)	Control line* <sup>3</sup>		
	3HP	4.2/5.3	5.5/6.9	14~10 (2~5.5)	11~10 (3.5~5.3)	30~14 (0.5~2)	TO-50EC(15A)	CU-11
	5HP	7/9.2	9.2/12.1	14~10 (2~5.5)	11~10 (3.5~5.3)	30~14 (0.5~2)	TO-50EC(15A)	CU-18
	7.5HP	11.3/13.3	14.8/17.5	10 (5.3)	11~10 (3.5~5.3)	30~14 (0.5~2)	TO-50EC(20A)	CU-18
	10HP	13.7/17.5	18/23	10 (5.3)	10 (5.3)	30~14 (0.5~2)	TO-50EC(30A)	CU-25
	15HP	18.3/23.6	24/31	8 (8.4)	8 (8.4)	30~14 (0.5~2)	TO-100S(50A)	CU-25
	20HP	23.6/29.0	31/38	8 (8.4)	8 (8.4)	30~14 (0.5~2)	TO-100S(50A)	CU-35
	25HP	29.7/33.5	39/44	8 (8.4)	8 (8.4)	30~14 (0.5~2)	TO-100S(50A)	CU-50
	30HP	34.3/44.2	45/58	6 (13.3)	8 (8.4)	30~14 (0.5~2)	TO-100S(75A)	CU-50
	40HP	45.7/55.6	60/73	4 (21.2)	8 (8.4)	30~14 (0.5~2)	TO-100S(100A)	CU-65
	50HP	57.2/67.1	75/88	4 (21.2)	6 (13.3)	30~14 (0.5~2)	TO-100S(100A)	CU-80
	60HP	69.3/78.5	91/103	2 (33.62)	6 (13.3)	30~14 (0.5~2)	TO-225S(150A)	CN-100
	75HP	89.9/111	118/145	2/0 (67.4)	4 (21.2)	30~14 (0.5~2)	TO-225S(175A)	CN-125
	100HP	114/128	150/168	3/0 (85)	4 (21.2)	30~14 (0.5~2)	TO-225S(225A)	CN-150
	125HP	137/159	180/208	300 (152)	4 (21.2)	30~14 (0.5~2)	TO-400S(300A)	CN-300
	150HP	165/191	216/250	300 (152)	4 (21.2)	30~14 (0.5~2)	TO-400S(300A)	CN-300
	175HP	198/226	260/296	400 (200)	2 (33.62)	30~14 (0.5~2)	TO-400S(400A)	CN-300
	215HP	225/250	295/328	500 (250)	2 (33.62)	30~14 (0.5~2)	TO-400S(400A)	CN-300
	270HP	290/332	380/435	600 (300)	2 (33.62)	30~14 (0.5~2)	TO-400S(400A)	SK-400
	300HP	343/393	450/515	500*2P (250*2P)	1/0 (50)	30~14 (0.5~2)	TO-800S(800A)	SK-600 (800A)
	375HP	400/446	523/585	500*2P (250*2P)	1/0 (50)	30~14 (0.5~2)	TE-1000(1000A)	SK-600 (800A)
	425HP	446/446	585/585	500*2P (250*2P)	1/0 (50)	30~14 (0.5~2)	TE-1000(1000A)	SK-600 (800A)
575V 3 Ø	1HP	1.7/3.0	1.7/3.0	14~10 (2~5.3)	14~10 (2~5.3)	30~14 (0.5~2)	TO-50EC(15A)	CU-11
	2HP	3/4.2	3/4.2	14~10 (2~5.3)	14~10 (2~5.3)	30~14 (0.5~2)	TO-50EC(15A)	CU-11
	3HP	4.2/5.8	4.2/5.8	14~10 (2~5.3)	11~10 (3.5~5.3)	30~14 (0.5~2)	TO-50EC(15A)	CU-11
	5HP	6.6/8.8	6.6/8.8	14~10 (2~5.3)	11~10 (3.5~5.3)	30~14 (0.5~2)	TO-50EC(15A)	CU-11
	7.5HP	9.9/12.1	9.9/12.2	11~10 (3.5~5.3)	11~10 (3.5~5.3)	30~14 (0.5~2)	TO-50EC(15A)	CU-18

A510s Model				wire diameter AWG(mm <sup>2</sup> )			NFB* <sup>4</sup>	MC* <sup>4</sup>
Power	horse power (HP)* <sup>1</sup>	Rated KVA HD/ND	Rated current (A) HD/ND	Main circuit* <sup>2</sup>	Grounding line E(G)	Control line* <sup>3</sup>		
	10HP	11.4/14.4	11.4/14.5	11~10 (3.5~5.3)	10 (5.3)	30~14 (0.5~2)	TO-50EC(20A)	CU-25
575~690V 3 Ø	15HP	17.9/22.7	15/19	10 (5.3)	8 (8.4)	30~14 (0.5~2)	TO-50EC(30A)	CU-25
	20HP	22.7/26.3	19/22	8 (8.4)	8 (8.4)	30~14 (0.5~2)	TO-50EC(30A)	CU-35
	25HP	26.3/32.3	22/27	8 (8.4)	8 (8.4)	30~14 (0.5~2)	TO-100S(50A)	CU-35
	30HP	32.3/40.6	27/34	8 (8.4)	8 (8.4)	30~14 (0.5~2)	TO-100S(50A)	CU-50
	40HP	40.6/50.2	34/42	8 (8.4)	8 (8.4)	30~14 (0.5~2)	TO-100S(50A)	CU-50
	50HP	50.2/62.1	42/52	6 (13.3)	8 (8.4)	30~14 (0.5~2)	TO-100S(75A)	CU-65
	60HP	64.5/74.1	54/62	6 (13.3)	6 (13.3)	30~14 (0.5~2)	TO-100S(100A)	CU-80
	75HP	74.1/95.6	62/80	4 (21.2)	6 (13.3)	30~14 (0.5~2)	TO-225S(150A)	CN-100
	100HP	103/118	86/99	2 (33.62)	4 (21.2)	30~14 (0.5~2)	TO-225S(150A)	CN-125
	125HP	114/149	99/125	2/0 (67.4)	2 (33.62)	30~14 (0.5~2)	TO-225S(175A)	CN-150
	150HP	157/175	131/147	2/0 (67.4)	2/0 (67.4)	30~14 (0.5~2)	TO-225S(175A)	CN-150
	175HP	176/194	147/163	3/0 (85)	2/0 (67.4)	30~14 (0.5~2)	TO-225S(225A)	CN-300
	215HP	195/253	163/212	300 (152)	3/0 (85)	30~14 (0.5~2)	TO-225S(225A)	CN-300
	250HP	230/258	192/216	300 (152)	300 (152)	30~14 (0.5~2)	TO-400S(400A)	CN-300
270HP	258/294	216/246	300 (152)	300 (152)	30~14 (0.5~2)	TO-400S(400A)	CN-300	

\*1: Constant torque rating.

\*2: The main circuit terminals: R/L1, S/L2, T/L3, U/T1, V/T2, W/T3, B1 / P, B2, ⊖, ♂

\*3: Control line is the terminal wire on the control board.

\*4: The NFB and MCB listed in the table are of TECO product numbers, products with same rated specification of other brands may be used. To reduce electrical noise interference, ensure that a RC surge absorber (R: 10Ω/5W, C: 0.1μf/1000VDC) is added to both sides of MCB coil.



### 3.17 Control Circuit Wiring

- (1) Separate the wiring for control circuit terminals from main circuit wiring for terminals (R/L1, S/L2, T/L3, U/T1, V/T2, W/T3).
- (2) Separate the wiring for control circuit terminals R1A-R1B-R1C (or R2A, R2C) (Relay outputs) from wiring for terminals ① - ⑧, A01, A02, GND, DO1, DO2, DOG, +10V, (-10V), A11, A12 and GND wiring.
- (3) Use shielded twisted-pair cables (#24 - #14 AWG / 0.5 -2 mm<sup>2</sup>) shown in Fig. 3.17.1 for control circuits to minimize noise problems. The maximum wiring distance should not exceed 50m (165 ft).

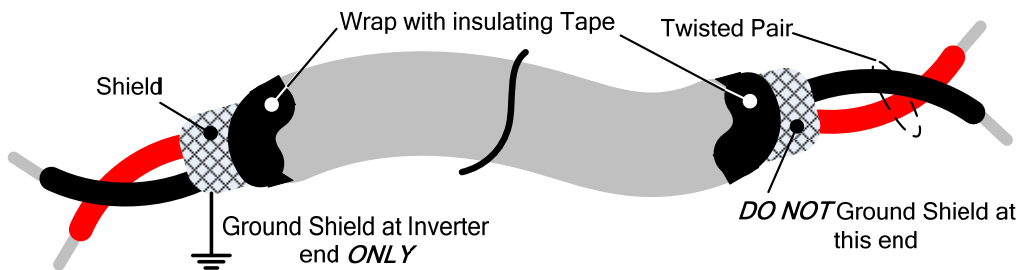

Fig. 3.17.1 Shielded Twisted-Pair

- (4) When the digital multi-function output terminals (DO1, DO2) are connected to an external relay, a freewheeling diode should be connected across the relay coil to prevent an inductive voltage spike from damaging the output circuitry as shown in Fig. 3.17.2 below.

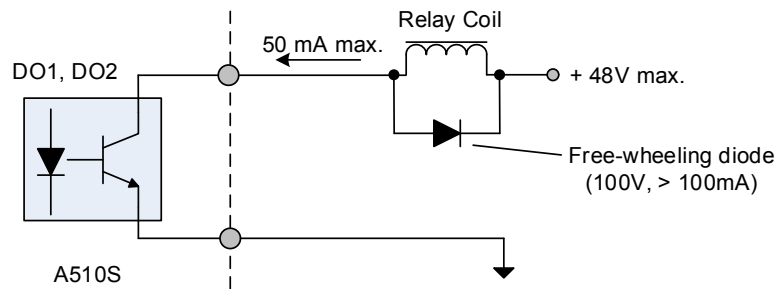
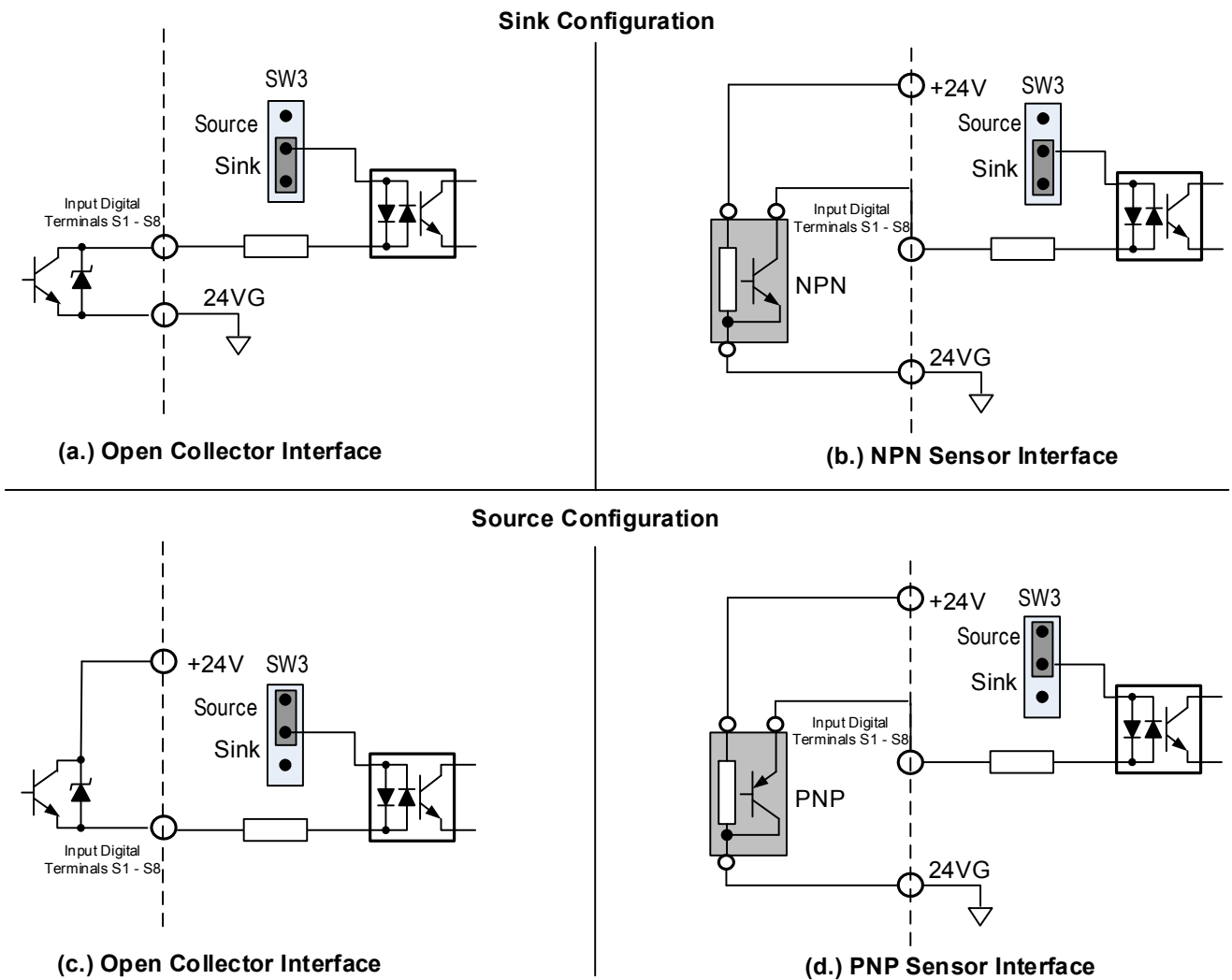

Fig. 3.17.2 Photo-Coupler Connected to an External Relay

- (5) In Section 3.8 the control boards referenced have a jumper SW3 that can select the digital input to terminals ① - ③ to be set for SINK or SOURCE. The following Fig. 3.17.3 (a.) – (d.) shows examples for the various SINK / Source interfaces.



**Fig. 3.17.3 Sink / Source Configurations**

## 3.18 Inverter Specifications

### Basic Specifications 200V class

Inverter capacity (HP)		1	2	3	5	7.5	10	15	20	25	
Output rated	Heavy Duty type	Rated output Capacity (KVA)	1.9	3	4.2	6.7	9.5	12.6	17.9	22.9	27.8
		Rated output current (A)	5	8	11	17.5	25	33	47	60	73
	H.D. (150%/1min)	Maximum applicable motor <sup>**</sup> HP	1	2	3	5	7.5	10	15	20	25
		(KW)	(0.75)	(1.5)	(2.2)	(3.7)	(5.5)	(7.5)	(11)	(15)	(18.5)
		Motor rated current (A) <sup>*1</sup>	3.4	6.1	8.7	13.5	20.1	25.1	36.7	50.3	62.9
	Normal Duty type N.D. (120%/1min)	Rated output Capacity (KVA)	2.3	3.7	4.6	8.4	11.4	16.0	21.3	26.3	30.1
		Rated output current (A)	6	9.6	12	22	30	42	56	69	80
		Maximum applicable motor <sup>**</sup> HP	2	3	5	7.5	10	15	20	25	30
		(KW)	(1.5)	(2.2)	(3.7)	(5.5)	(7.5)	(11)	(15)	(18.5)	(22)
		Motor rated current (A) <sup>*1</sup>	6.1	8.7	13.5	20.1	25.1	36.7	50.3	62.9	72.9
The maximum output voltage (V)		3-phase, 200V ~ 240V									
The maximum output frequency (Hz)		Based on parameter setting 0.1~599.0 Hz									
Power	Rated voltage, frequency	Single/3-phase 200V~240V, 50/60Hz				3-phase 200V~240V, 50/60Hz					
	Allowable voltage fluctuation	-15% ~ +10%									
	Allowable frequency fluctuation	±5%									

Inverter capacity (HP)		30	40	50	60	75	100	125	150	
Output rated	Heavy Duty type	Rated output Capacity (KVA)	32.4	43.8	55.3	68.6	81.9	108	132	158
		Rated output current (A)	85	115	145	180	215	283	346	415
	H.D. (150%/1min)	Maximum applicable motor <sup>**</sup> HP	30	40	50	60	75	100	125	150
		(KW)	(22)	(30)	(37)	(45)	(55)	(75)	(90)	(110)
		Motor rated current (A) <sup>*1</sup>	72.9	96.7	124	143.5	183.5	230	272	344
	Normal Duty type N.D. (120%/1min)	Rated output Capacity (KVA)	41.9	52.6	64.4	76.2	95.3	118.9	152.4	172
		Rated output current (A)	110	138	169	200	250	312	400	450
		Maximum applicable motor <sup>**</sup> HP	40	50	60	75	100	125	150	175
		(KW)	(30)	(37)	(45)	(55)	(75)	(90)	(110)	(130)
		Motor rated current (A) <sup>*1</sup>	96.7	124	143.5	183.5	230	272	344	370
The maximum output voltage (V)		3-phase, 200V ~ 240V								
The maximum output frequency (Hz)		Based on parameter setting 0.1~599.0 Hz								
Power	Rated voltage, frequency	Single/3-phase 200V~240V, 50/60Hz				3-phase 200V~240V, 50/60Hz				
	Allowable voltage fluctuation	-15% ~ +10%								
	Allowable frequency fluctuation	±5%								

### Basic Specifications 400V class

Inverter capacity (HP)			1	2	3	5	7.5	10	15	20	25	30	
Output rated	Heavy Duty type H.D. (150%/1min)	Rated output Capacity (KVA)	2.6	3.2	4.2	7	11.3	13.7	18.3	23.6	29.7	34.3	
		Rated output current (A)	3.4	4.2	5.5	9.2	14.8	18	24	31	39	45	
		Maximum applicable motor **HP (KW)	1 (0.75)	2 (1.5)	3 (2.2)	5 (3.7)	7.5 (5.5)	10 (7.5)	15 (11)	20 (15)	25 (18.5)	30 (22)	
		Motor rated current (A)**1	1.7	3.1	4.2	7	10.1	12.6	18.6	24.8	31.1	36.3	
	Normal Duty type N.D. (120%/1min)	Rated output Capacity (KVA)	3.1	4.1	5.3	9.2	13.3	17.5	23.6	29.0	33.5	44.2	
		Rated output current (A)	4.1	5.4	6.9	12.1	17.5	23	31	38	44	58	
		Maximum applicable motor **HP (KW)	2 (1.5)	3 (2.2)	5 (3.7)	7.5 (5.5)	10 (7.5)	15 (11)	20 (15)	25 (18.5)	30 (22)	40 (30)	
		Motor rated current (A)**1	3.1	4.2	7	10.1	12.6	18.6	24.8	31.1	36.3	48.7	
	The maximum output voltage (V)			3-phase 380V~ 480V									
	The maximum output frequency (Hz)			Based on parameter setting 0.1~599.0 Hz									
Power	Rated voltage, frequency			3-phase 380V ~ 480V, 50/60Hz									
	Allowable voltage fluctuation			-15% ~ +10%									
	Allowable frequency fluctuation			±5%									

Inverter capacity (HP)			40	50	60	75	100	125	150	175	215		
Output rated	Heavy Duty type H.D. (150%/1min)	Rated output Capacity (KVA)	45.7	57.2	69.3	89.9	114	137	165	198	225		
		Rated output current (A)	60	75	91	118	150	180	216	260	295		
		Maximum applicable motor **HP (KW)	40 (30)	50 (37)	60 (45)	75 (55)	100 (75)	125 (90)	150 (110)	175 (132)	215 (160)		
		Motor rated current (A)**1	48.7	59	70.5	88	114	145	175	205	248		
	Normal Duty type N.D. (120%/1min)	Rated output Capacity (KVA)	55.6	67.1	78.5	111	128	159	191	226	250		
		Rated output current (A)	73	88	103	145	168	208	250	296	328		
		Maximum applicable motor **HP (KW)	50 (37)	60 (45)	75 (55)	100 (75)	125 (90)	150 (110)	175 (132)	215 (160)	250 (185)		
		Motor rated current (A)**1	59	70.5	88	114	145	175	205	248	270		
	The maximum output voltage (V)			3-phase 380V~480V									
	The maximum output frequency (Hz)			Based on parameter setting 0.1~599.0 Hz									
Power	Rated voltage, frequency			3-phase 380V ~ 480V, 50/60Hz									
	Allowable voltage fluctuation			-15% ~ +10%									
	Allowable frequency fluctuation			±5%									

Inverter capacity (HP)		270	300	375	425	
Output rated	Heavy Duty type H.D. (150%/1min)	Rated Output capacity (KVA)	290	343	400	446
		Rated output current (A)	380	450	523	585
		Maximum applicable motor **HP (KW)	270 (200)	300 (220)	375 (280)	425 (315)
		Motor rated current (A)**1	300	348	465	500
	Normal Duty type N.D. (120%/1min)	Rated Output capacity (KVA)	332	393	446	446
		Rated output current (A)	435	515	585	585
		Maximum applicable motor **HP (KW)	300 (220)	335 (250)	425 (315)	425 (315)
		Motor rated current (A)**1	348	465	500	615
	The maximum output voltage (V)		3-phase 380V~480V			
	The maximum output frequency (Hz)		Based on parameter setting 0.1~ 599.0 Hz			
Power	Rated voltage, frequency		3-phase 380V ~ 480V, 50/60Hz			
	Allowable voltage fluctuation		-15% ~ +10%			
	Allowable frequency fluctuation		±5%			

### Basic Specifications 575/690V class

Inverter capacity (HP)		1	2	3	5	7.5	10	15	20	25	30	
Output rated	Rated output Capacity (KVA)		1.7	3.0	4.2	6.6	9.9	11.4	17.9	22.7	26.3	32.3
	Heavy Duty type H.D. (150%/1min)	Rated output current (A)	1.7	3.0	4.2	6.6	9.9	11.4	15	19	22	27
		Maximum applicable motor **HP (KW) for 575v	1 (0.75)	2 (1.5)	3 (2.2)	5 (3.7)	7.5 (5.5)	10 (7.5)	10 (7.5)	15 (11)	20 (15)	25 (18.5)
		Maximum applicable motor **HP (KW) for 690v	1 (0.75)	2 (1.5)	3 (2.2)	5 (3.7)	7.5 (5.5)	10 (7.5)	15 (11)	20 (15)	25 (18.5)	30 (22)
	Rated output Capacity (KVA)		3.0	4.2	5.8	8.8	12.2	14.5	22.7	26.3	32.3	40.6
	Normal Duty type N.D. (120%/1min)	Rated output current (A)	3.0	4.2	5.8	8.8	12.2	14.5	19	22	27	34
		Maximum applicable motor **HP (KW) for 575v	2 (1.5)	3 (2.2)	5 (3)	7.5 (5.5)	10 (7.5)	15 (11)	15 (11)	20 (15)	25 (18.5)	30 (22)
		Maximum applicable motor **HP (KW) for 690v	-	-	-	-	-	-	20 (15)	25 (18.5)	30 (22)	40 (30)
	The maximum output voltage (V)		3-phase 575/690V									
	The maximum output frequency (Hz)		Based on parameter setting 0.1~599.0 Hz									
Power	Rated voltage, frequency		3-phase 500~600V, 50/60Hz					3-phase 575~690V, 50/60Hz				
	Allowable voltage fluctuation		-15% ~ +10%									
	Allowable frequency fluctuation		±5%									

Inverter capacity (HP)		40	50	60	75	100	125	150	175	215	250	270	
Output rated	Rated output Capacity (KVA)	40.6	50.2	64.5	74.1	103	114	157	176	195	230	258	
	Heavy Duty type H.D. (150%/1min)	Rated output current (A)	34	42	54	62	86	99	131	147	163	192	216
		Maximum applicable motor *1HP (KW) for 575v	30 (22)	40 (30)	50 (37)	60 (45)	75 (55)	100 (75)	125 (90)	150 (110)	150 (110)	200 (150)	200 (150)
		Maximum applicable motor *1HP (KW) for 690v	40 (30)	50 (37)	60 (45)	75 (55)	100 (75)	125 (90)	150 (110)	175 (132)	215 (160)	250 (185)	270 (202)
	Rated output Capacity (KVA)	50.2	64.5	74.1	95.6	114	149	176	195	253	258	294	
	Normal Duty type N.D. (120%/1min)	Rated output current (A)	42	52	62	80	99	125	147	163	212	216	246
		Maximum applicable motor *1HP (KW) for 575v	40 (30)	50 (37)	60 (45)	75 (55)	100 (75)	125 (90)	150 (110)	150 (110)	200 (150)	200 (150)	250 (185)
		Maximum applicable motor *1HP (KW) for 690v	50 (37)	60 (45)	75 (55)	100 (75)	125 (90)	150 (110)	175 (132)	215 (160)	250 (185)	270 (202)	335 (251)
	The maximum output voltage (V)	3-phase 575/690V											
	The maximum output frequency (Hz)	Based on parameter setting 0.1~599.0 Hz											
Power	Rated voltage, frequency	3-phase 575~690v, 50/60Hz											
	Allowable voltage fluctuation	-15% ~ +10%											
	Allowable frequency fluctuation	±5%											

\*1: Take TECO standard 4-pole induction motor as the base.

\*2: A510s model is designed to use in heavy duty conditions, the factory setting is the HD (Heavy Duty type) mode.

\*3: The overload capacity of A510s model HD (Heavy Duty) is 150% / 1min, 200% / 2sec. See the table below for the carrier frequency default setting and range.

\*4: The overload capacity of A510s model ND (Normal Duty) is 120%/1min, carrier range: 2 KHz ~ 16 KHz, the default setting is 2 KHz. The default setting is 1.5 KHz for 575/690v inverter that over 215hp

\*5: If it is greater than default carrier frequency, you need to adjust the load current based on the de-rating curve.

Inverter Voltage and Capacity		HD mode	HD mode
200V class	400V class	carrier frequency range	carrier frequency factory setting
1~20HP	1~30HP	2~16KHz	8KHz
25HP	-	2~12KHz	6KHz
30~40HP	40~50HP	2~12KHz (*6)	5KHz
50~100HP	60~175HP	2~10KHz (*6)	5KHz
	125HP	2~10KHz	4KHz
125~150HP	215HP	2~8KHz	3KHz
		2~5KHz	5KHz
	270-375HP	2~5KHz	4KHz
	425HP	2~5KHz	2KHz

Inverter Voltage and Capacity		HD mode	HD mode
575V class	690V class	carrier frequency range	carrier frequency factory setting
1~10HP	-	1.5~16KHz	8KHz
15~75HP	15~75HP	1.5~8KHz	4KHz
100~150HP	100~150HP	1.5~6KHz	3KHz
175~270HP	175~270HP	1.5~4KHz	2KHz

\*6: If control mode (00-00) is set to 2 (SLV mode) and maximum frequency (01-02) is larger than 80Hz, the carrier frequency range is 2~8 KHz.

The following table shows maximum output frequency for each control mode.

Duty Cycle	Control mode	Other settings	Maximum output frequency
Heavy Duty (00-27=0)	V/F V/F + PG SLV2	maximum frequency set to 599Hz	599Hz
	SLV	200V 1~10HP, 400V 1~15HP	150Hz
		200V 15~25HP, 400V 20HP	110Hz
		400V 25~30HP	100Hz
		200V 30~100HP, 400V 40~215HP, carrier (11-01) is set as 8K or below 8K	100Hz
		200V 125~150HP, 400V 220~425HP, carrier (11-01) is set as 5K or below 5K	
		200V 30~100HP, 400V 40~175HP, carrier (11-01) is above 8K	80Hz
	SV	unlimited	599Hz
	PMSV	unlimited	Twice of Base frequency
PMSLV	unlimited	599Hz	
Normal Duty (00-27=1)	V/F V/F + PG	maximum frequency set to 120Hz	120Hz
	SLV /SV PMSV/ PMSLV SLV2	No normal duty mode	-

## General Specifications

Control characteristics	Operation mode	LCD keypad with parameter copy function (Optional Seven-segment display * 5 + LED keypad)
	Control mode	V/F, V/F+PG, SLV, SV, PMSV, PMSLV, SLV2* with space vector PWM mode
	Frequency control range	0.1Hz~599.0Hz
	Output frequency accuracy (Temperature change)	Digital references: $\pm 0.01\%$ (-10 to +40°C) Analog references: $\pm 0.1\%$ (25°C $\pm 10^\circ\text{C}$ )
	Speed control accuracy	$\pm 0.1\%$ ( vector control(SV)), $\pm 0.5\%$ ( vector control / open-loop)
	Frequency setting resolution	Digital references: 0.01Hz, Analog references: 0.03Hz/60Hz (If the maximum output frequency of motor is over 300HZ,the frequency resolution is changed to 0.1Hz )
	Output frequency resolution	0.01Hz (If the maximum output frequency of motor is over 300HZ,the frequency resolution is changed to 0.1Hz )
	Inverter overload	Rated output current 150%/1 min, 200%/2sec (HD mode),120%/1 min (ND mode) Factory 150%/1 min, 200%/2sec
	Frequency setting signal	0 to +10VDC / 4 to 20mA or -10V to +10VDC and pulse input command frequency
	Acceleration / deceleration time	0.0 - 6000.0 second (separately set acceleration and deceleration time )
	Voltage, frequency characteristics	Custom V/f curve based on parameters
	Braking torque	About 20%
	Main control functions	Auto-tuning, Zero Servo, torque control, position control, Droop, Soft-PWM, over-voltage protection, dynamic braking, speed search, frequency traversing, instantaneous power fault restart, PID control, automatic torque compensation, automatic speed regulation, RS-485 communication standard, speed feedback control, simple PLC function, 2 sets of analog outputs, safety switch.
	Other functions	Accumulated power-on / run time, 30 sets of fault history records and latest fault record state, energy-saving function setting, single phase protection, smart braking, DC braking, Dwell, S curve acceleration and deceleration, Up / Down operation, MODBUS protocol, pulse output, engineering units, SINK / SOURCE digital inputs, RTC function (only for enhanced LCD type).
Efficiency	Meet IEC/EN 61800-9-2 IE2 Class	
Protection functions	Stall protection	Stall prevention level can be set independently in acceleration, deceleration and constant speed.
	Instantaneous over current (OC) and output short-circuit (SC) protection	Inverter stops when the output current exceeds 200% of the inverter rated current.
	Inverter overload Protection (OL2)	HD mode: If inverter rated current 150%/1 min., or 200%/2sec is exceeded inverter stops, factory default carrier frequency setting is 8~2KHz. ND mode: If inverter rated current 120%/1 min is exceeded inverter stops , factory default carrier frequency is 2KHz.
	Motor overload (OL1) protection	Electrical overload protection curve I <sup>2</sup> T
	Over voltage(OV) protection	If the main circuit DC voltage rises over 410V (200V class) / 820V (400V class), and over 1050V (575V class) / 1230V (690V class),the motor stops running.
	Under voltage (UV)	If the main circuit DC voltage falls below 190V (200V class) / 380V (400V class),and 546V (575/690V class), the motor stops running.
	Automatic restart after instantaneous power fault	Power fault exceeds 15ms. Automatic restart function available after instantaneous power fault in 2sec.
	Overheat protection(OH)	Uses temperature sensor for protection.
	Ground Fault protection(GF)	Use current sensor for protection.
	DC bus charge indicator	When main circuit DC voltage $\geq 50\text{V}$ , the CHARGE LED turns on.
	Input phase loss protection (IPL)	If the IPL is detected the motor stops automatically.
	Output phase loss protection (OPL)	If the OPL is detected the motor stops automatically.
	Short-circuit current rating (SCCR)	Per UL 508C, the drive is suitable for use on a circuit capable of delivering not more than 100KA symmetrical amperes (rms) when protected by fuses given in the fuse table



<b>Environment Specification</b>	Location	Indoor (protected from corrosive gases and dust).
	Ambient temperature	-10~+40°C (14°F~104°F) (IP20/IP21), -10~+50°C (14°F~122°F) (IP00 or top anti-dust cover removed); with de-rating, its maximum operation temperature is 60°C (140°F) (Enhanced type frame 5 is 50°C without de-rating)
	Storage temperature	-20~+70°C (-4°F~+158°F)
	Humidity	95%RH or less ( no condensation )
	Altitude	1000m (3281ft) or below without de-rating ; 1000~3000m (9843ft) with de-rating
	Vibration	1.0G, in compliance with IEC 60068-2-6 ;
	Pollution degree	Meet IEC 60721-3-3 Class 3C3
Communication function		RS-485 standard (MODBUS RTU / ASCII protocol) (RJ45 & S(+), S(-) terminal)
PLC function		Built-in
EMI protection		The built-in noise filter complies with EN61800-3 available for inverters 400V 60HP or below.
EMS protection		EN61800-3
Certification	CE	EN61800-3 (CE & RE) EN61800-5-1 (LVD)
	UKCA	BS EN61800-3 (CE & RE) BS EN61800-5-1 (LVD)
	UL	UL508C

### 3.19 Inverter Derating Based on Carrier Frequency

#### 200V Models

##### 1 - 20 HP

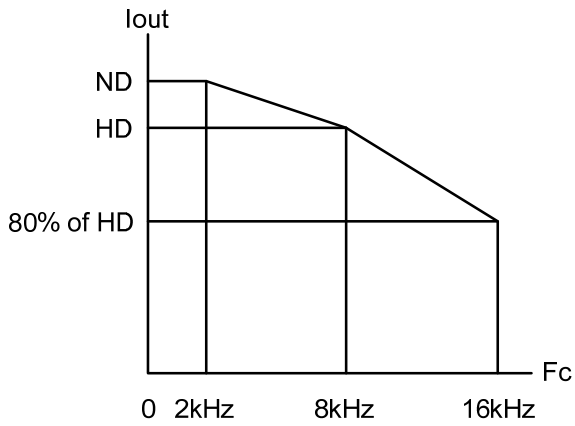

##### 25 HP

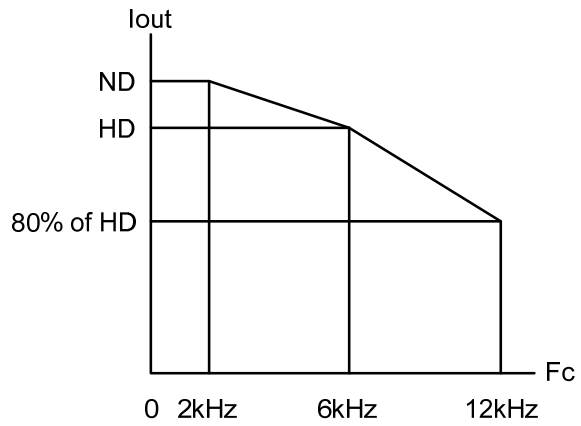

##### 30 - 40 HP

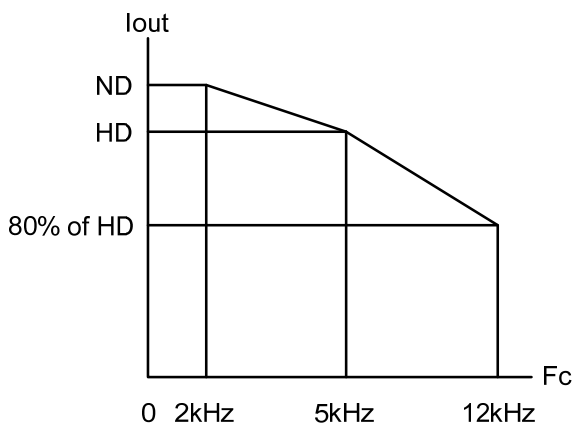

##### 50 - 100 HP

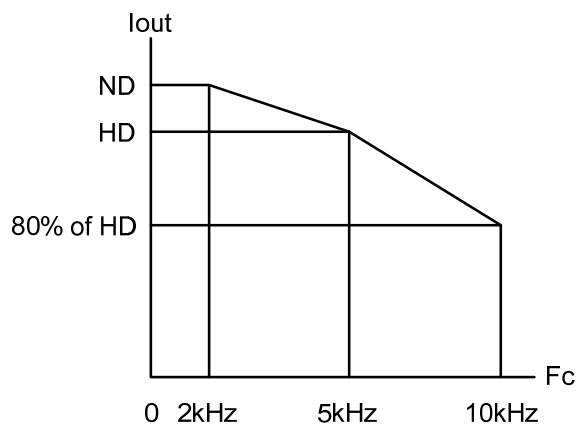

##### 125 - 150 HP

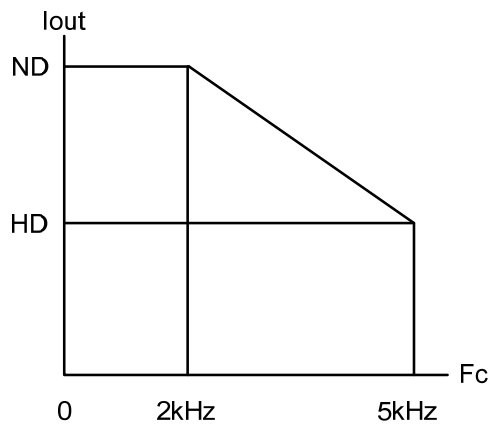

## 400V Models

### 1 - 30 HP

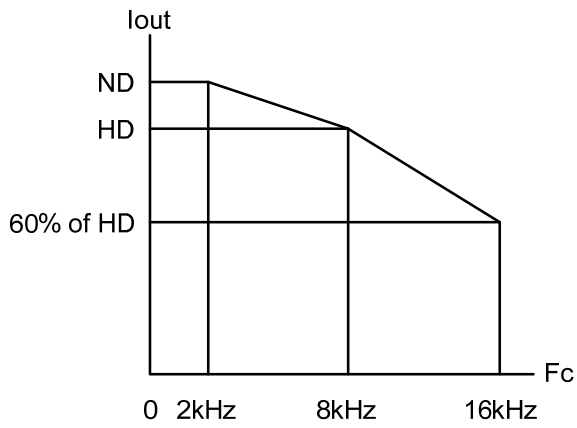

### 40 - 50 HP

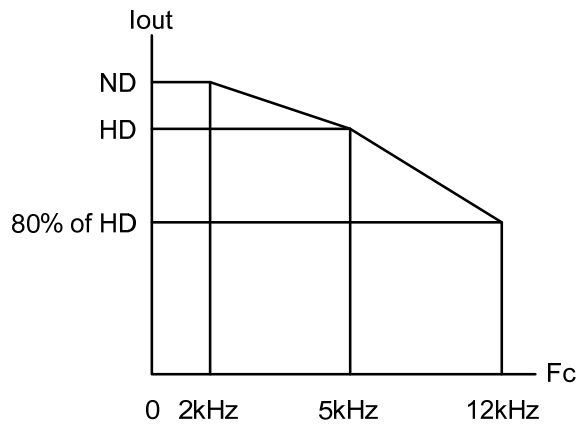

### 60 - 100 HP & 150~175HP

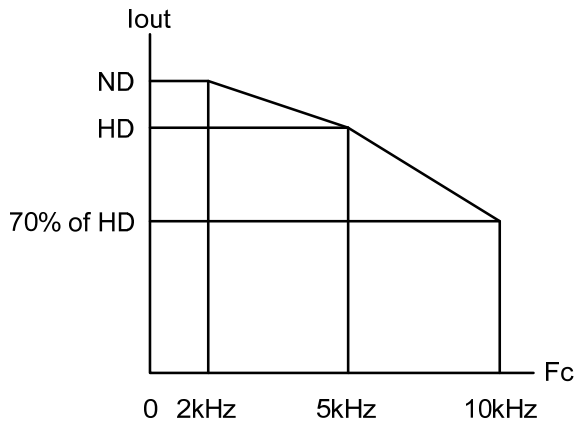

### 125 HP

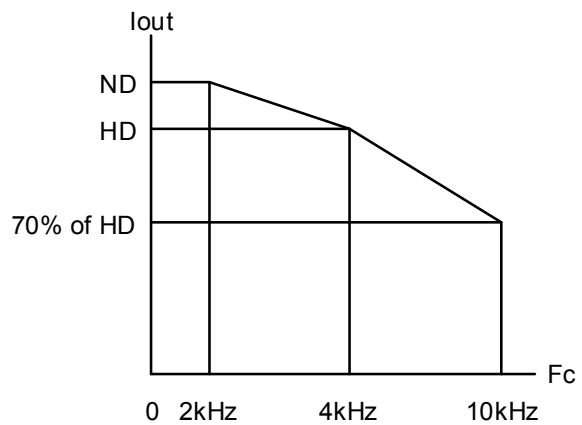

### 215 HP

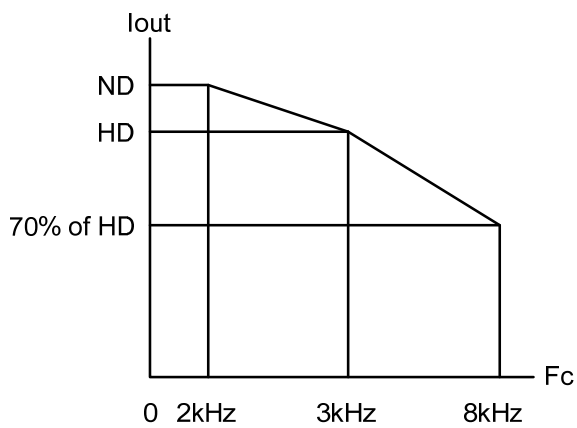

**215H(Note) - 375 HP**

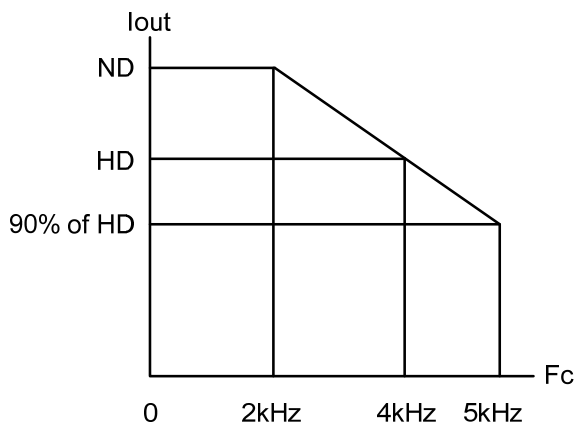

**425 HP**

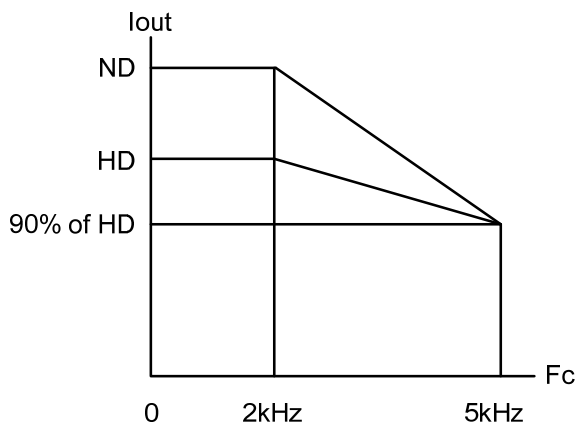

**Note:** The spec. please refer to Chapter 3.18, the rated current is 330/370A.

**575/690V Models**

**575V 1 - 10 HP**

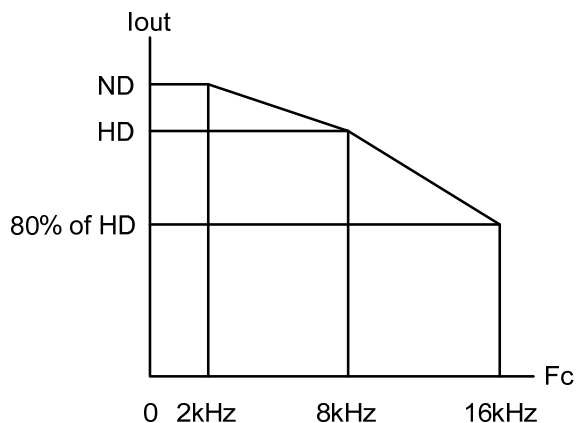

**575/690V 15 - 30 HP**

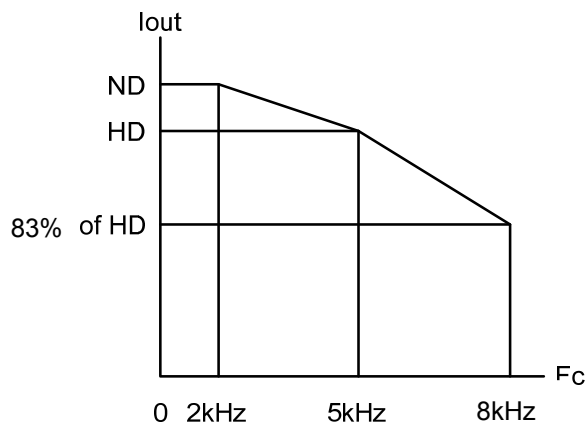

**575/690V 40 - 60 HP**

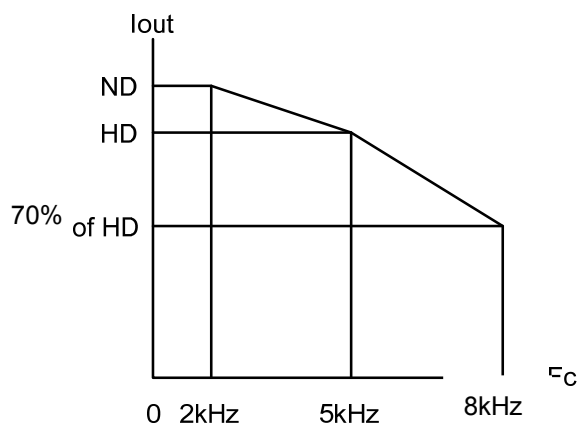

**575/690V 75HP**

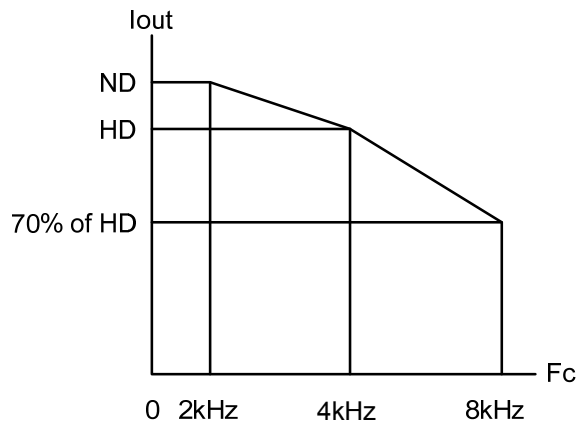

**575/690V 100 - 150 HP**

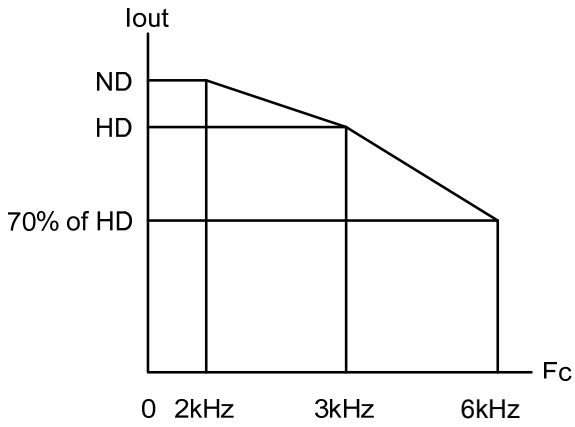

**575/690V 175 - 270 HP**

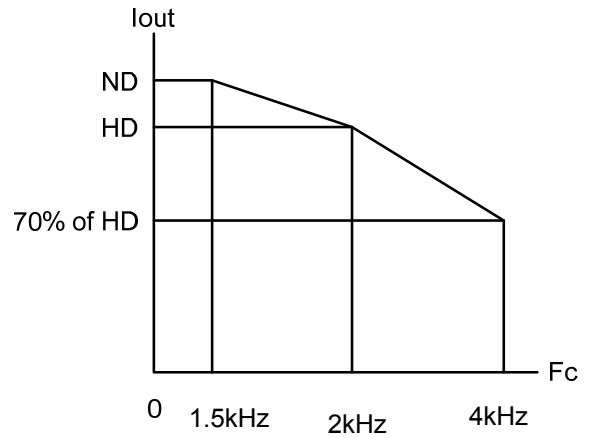

**3.20 Inverter Derating Based on Temperature**

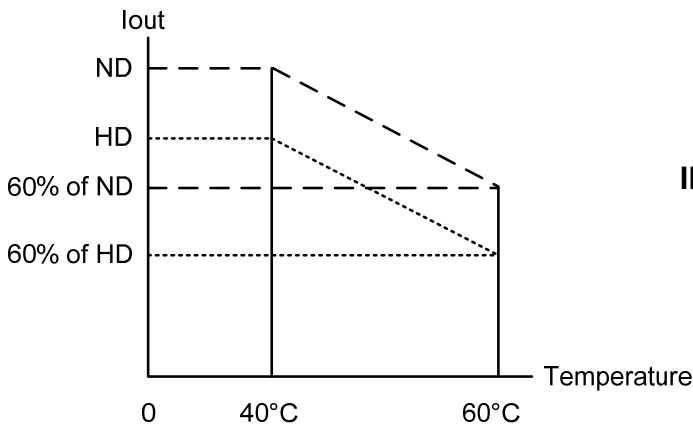

**IP20**

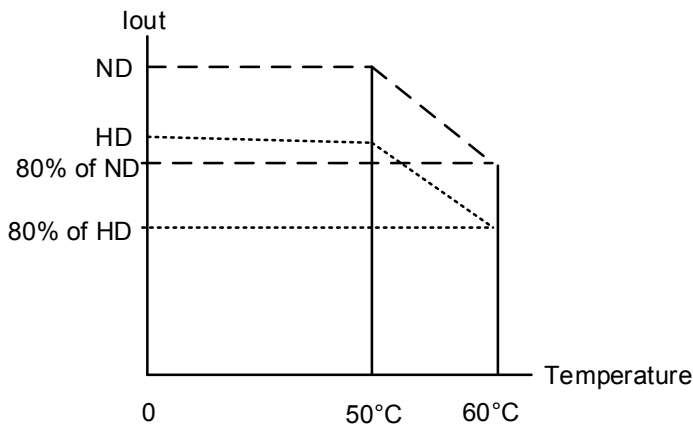

**IP00**

### ◆ Capacitor reforming Guide after long storage

For correct performance of this product after long storage before use it is important that Inverter Capacitors are reformed according to the guide below:

Storage time	Procedure to re-apply voltage
$\leq 1$ year	Apply rated voltage(*1) of inverter in the normal way
Between 1-2 years	Apply rated voltage of inverter to the product for one hour
$\geq 2$ years	Use a variable AC power supply to 1. Connecting 25% of inverter rated voltage for 30 minutes. 2. Connecting 50% of inverter rated voltage for 30 minutes. 3. Connecting 75% of inverter rated voltage for 30 minutes. 4. Connecting 100% of inverter rated voltage for 210 minutes. Once the procedures completed, inverter just can be used normally.

\*1 : Rated voltage: please connects rated voltage according to model label of inverter.

### 3.21 Inverter Dimensions

(a) 200V: 1 – 7.5HP / 400V: 1 - 7.5HP/ 575V:1-3HP (IP20/NEMA1)

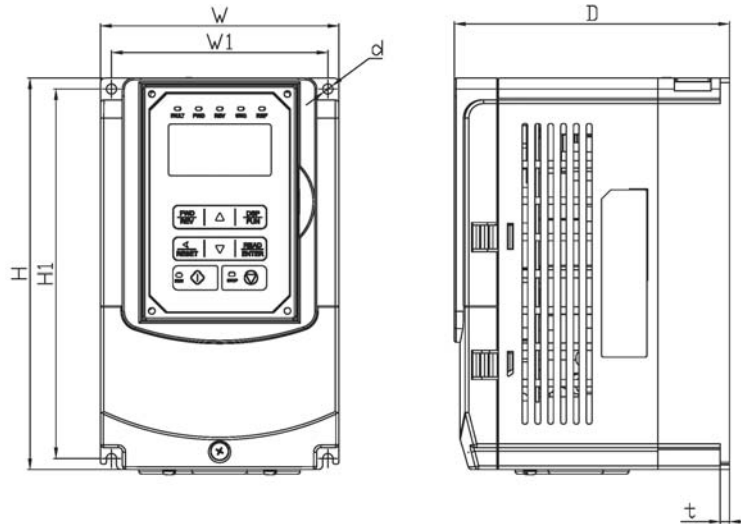

Inverter Model	Dimensions in mm (inch)							Net Weight in kg (lbs)
	W	H	D	W1	H1	t	d	
A510-2001-S□	130 (5.12)	215 (8.46)	150 (5.91)	118 (4.65)	203 (7.99)	5 (0.20)	M5	2.2 (4.9)
A510-2002-S□	130 (5.12)	215 (8.46)	150 (5.91)	118 (4.65)	203 (7.99)	5 (0.20)	M5	2.2 (4.9)
A510-2003-S□	140 (5.51)	279.5 (11.00)	181 (7.13)	122 (4.80)	267 (10.51)	1.2 (0.05)	M6	3.8 (8.4)
A510-2005-S□3	140 (5.51)	279.5 (11.00)	181 (7.13)	122 (4.80)	267 (10.51)	1.2 (0.05)	M6	3.8 (8.4)
A510-2008-S□3	140 (5.51)	279.5 (11.00)	181 (7.13)	122 (4.80)	267 (10.51)	1.2 (0.05)	M6	3.8 (8.4)
A510-4001-S□3	130 (5.12)	215 (8.46)	150 (5.91)	118 (4.65)	203 (7.99)	5 (0.20)	M5	2.2 (4.9)
A510-4002-S□3	130 (5.12)	215 (8.46)	150 (5.91)	118 (4.65)	203 (7.99)	5 (0.20)	M5	2.2 (4.9)
A510-4003-S□3	130 (5.12)	215 (8.46)	150 (5.91)	118 (4.65)	203 (7.99)	5 (0.20)	M5	2.2 (4.9)
A510-4005-S□3	140 (5.51)	279.5 (11.00)	181 (7.13)	122 (4.80)	267 (10.51)	1.2 (0.05)	M6	3.8 (8.4)
A510-4008-S□3	140 (5.51)	279.5 (11.00)	181 (7.13)	122 (4.80)	267 (10.51)	1.2 (0.05)	M6	3.8 (8.4)
A510-5001-S□3	140 (5.51)	279.5 (11.00)	181 (7.13)	122 (4.80)	267 (10.51)	1.2 (0.05)	M6	3.8 (8.4)
A510-5002-S□3	140 (5.51)	279.5 (11.00)	181 (7.13)	122 (4.80)	267 (10.51)	1.2 (0.05)	M6	3.8 (8.4)
A510-5003-S□3	140 (5.51)	279.5 (11.00)	181 (7.13)	122 (4.80)	267 (10.51)	1.2 (0.05)	M6	3.8 (8.4)

(b) 200V: 10 - 25HP / 400V: 10 - 30HP / 575V: 5~10HP / 690V: 15~40HP (IP20/NEMA1)

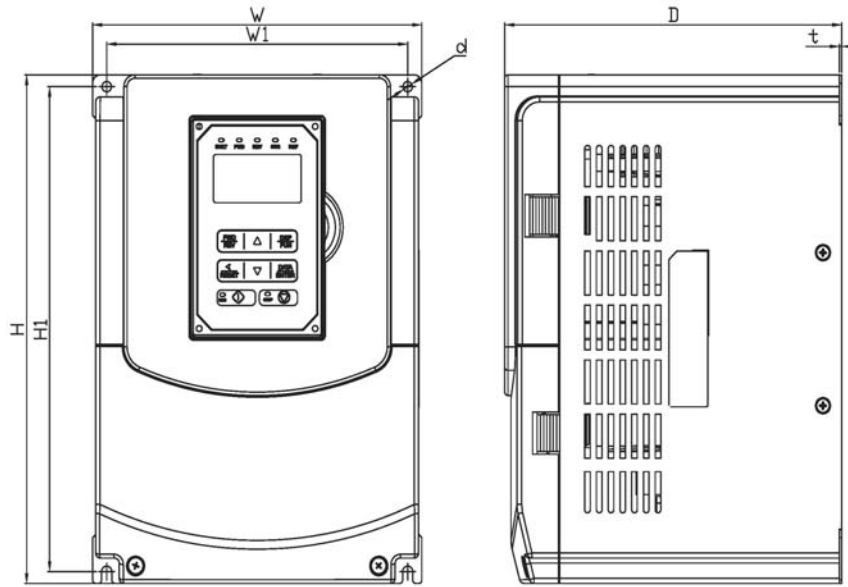

Inverter Model	Dimensions in mm (inch)							Net Weight in kg (lbs)
	W	H	D	W1	H1	t	d	
A510-2010-S□3	210 (8.27)	300 (11.81)	215 (8.46)	192 (7.56)	286 (11.26)	1.6 (0.06)	M6	6.2 (13.67)
A510-2015-S□3	265 (10.43)	360 (14.17)	225 (8.86)	245 (9.65)	340 (13.39)	1.6 (0.06)	M8	10 (22.05)
A510-2020-S□3	265 (10.43)	360 (14.17)	225 (8.86)	245 (9.65)	340 (13.39)	1.6 (0.06)	M8	10 (22.05)
A510-2025-S□3	265 (10.43)	360 (14.17)	225 (8.86)	245 (9.65)	340 (13.39)	1.6 (0.06)	M8	10 (22.05)
A510-4010-S□3	210 (8.27)	300 (11.81)	215 (8.46)	192 (7.56)	286 (11.26)	1.6 (0.06)	M6	6.2 (13.67)
A510-4015-S□3	210 (8.27)	300 (11.81)	215 (8.46)	192 (7.56)	286 (11.26)	1.6 (0.06)	M6	6.2 (13.67)
A510-4020-S□3	210 (8.27)	300 (11.81)	215 (8.46)	192 (7.56)	286 (11.26)	1.6 (0.06)	M6	6.2 (13.67)
A510-4025-S□3	265 (10.43)	360 (14.17)	225 (8.86)	245 (9.65)	340 (13.39)	1.6 (0.06)	M8	10 (22.05)
A510-4030-S□3	265 (10.43)	360 (14.17)	225 (8.86)	245 (9.65)	340 (13.39)	1.6 (0.06)	M8	10 (22.05)
A510-5005-S□3	210 (8.27)	300 (11.81)	215 (8.46)	192 (7.56)	286 (11.26)	1.6 (0.06)	M6	6.2 (13.67)
A510-5008-S□3	210 (8.27)	300 (11.81)	215 (8.46)	192 (7.56)	286 (11.26)	1.6 (0.06)	M6	6.2 (13.67)
A510-5010-S□3	210 (8.27)	300 (11.81)	215 (8.46)	192 (7.56)	286 (11.26)	1.6 (0.06)	M6	6.2 (13.67)
A510-6015-S□3	265 (10.43)	360 (14.17)	225 (8.86)	245 (9.65)	340 (13.39)	1.6 (0.06)	M8	10 (22.05)



Inverter Model	Dimensions in mm (inch)							Net Weight in kg (lbs)
	W	H	D	W1	H1	t	d	
A510-6020-S□3	265 (10.43)	360 (14.17)	225 (8.86)	245 (9.65)	340 (13.39)	1.6 (0.06)	M8	10 (22.05)
A510-6025-S□3	265 (10.43)	360 (14.17)	225 (8.86)	245 (9.65)	340 (13.39)	1.6 (0.06)	M8	10 (22.05)
A510-6030-S□3	265 (10.43)	360 (14.17)	225 (8.86)	245 (9.65)	340 (13.39)	1.6 (0.06)	M8	10 (22.05)
A510-6040-S□3	265 (10.43)	360 (14.17)	225 (8.86)	245 (9.65)	340 (13.39)	1.6 (0.06)	M8	10 (22.05)

(c) 200V: 30 - 40HP / 400V: 40 - 75HP / 690V 50~75HP (IP20/NEMA1)

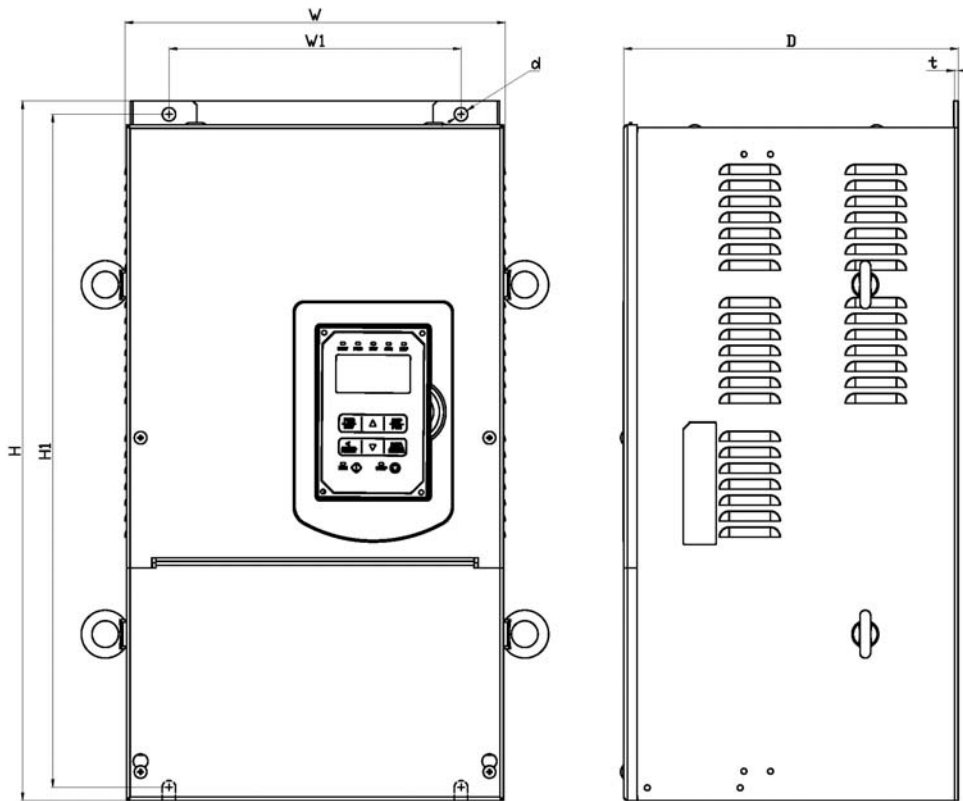

Inverter Model	Dimensions in mm (inch)							Net Weight in kg (lbs)
	W	H	D	W1	H1	t	d	
A510-2030-S□3	288 (11.34)	526 (20.71)	Note	160 (6.30)	505 (19.88)	3.3 (0.13)	M8	27 (59.52)
A510-2040-S□3	288 (11.34)	526 (20.71)		160 (6.30)	505 (19.88)	3.3 (0.13)	M8	27 (59.52)
A510-4040-S□3	288 (11.34)	526 (20.71)		160 (6.30)	505 (19.88)	3.3 (0.13)	M8	27 (59.52)
A510-4050-S□3	288 (11.34)	526 (20.71)		160 (6.30)	505 (19.88)	3.3 (0.13)	M8	27 (59.52)
A510-4060-S□3	288 (11.34)	526 (20.71)		160 (6.30)	505 (19.88)	3.3 (0.13)	M8	27 (59.52)
A510-4075-S□3	288 (11.34)	526 (20.71)		160 (6.30)	505 (19.88)	3.3 (0.13)	M8	27 (59.52)
A510-6050-S□3	288 (11.34)	526 (20.71)		160 (6.30)	505 (19.88)	3.3 (0.13)	M8	27 (59.52)
A510-6060-S□3	288 (11.34)	526 (20.71)		160 (6.30)	505 (19.88)	3.3 (0.13)	M8	27 (59.52)
A510-6075-S□3	288 (11.34)	526 (20.71)		160 (6.30)	505 (19.88)	3.3 (0.13)	M8	27 (59.52)
A510-4040-SE3-B	286.5 (11.28)	526 (20.71)	252 (9.92)	160 (6.30)	505 (19.88)	3.3 (0.13)	M8	28 (52.91)
A510-4040-SG3-B								

Note: Standard type is 252mm (9.92 inch), Enhanced type is 272mm (10.70 inch)

200V: 50 - 100HP / 400V: 100 - 215HP / 690V: 100~270HP (IP00)

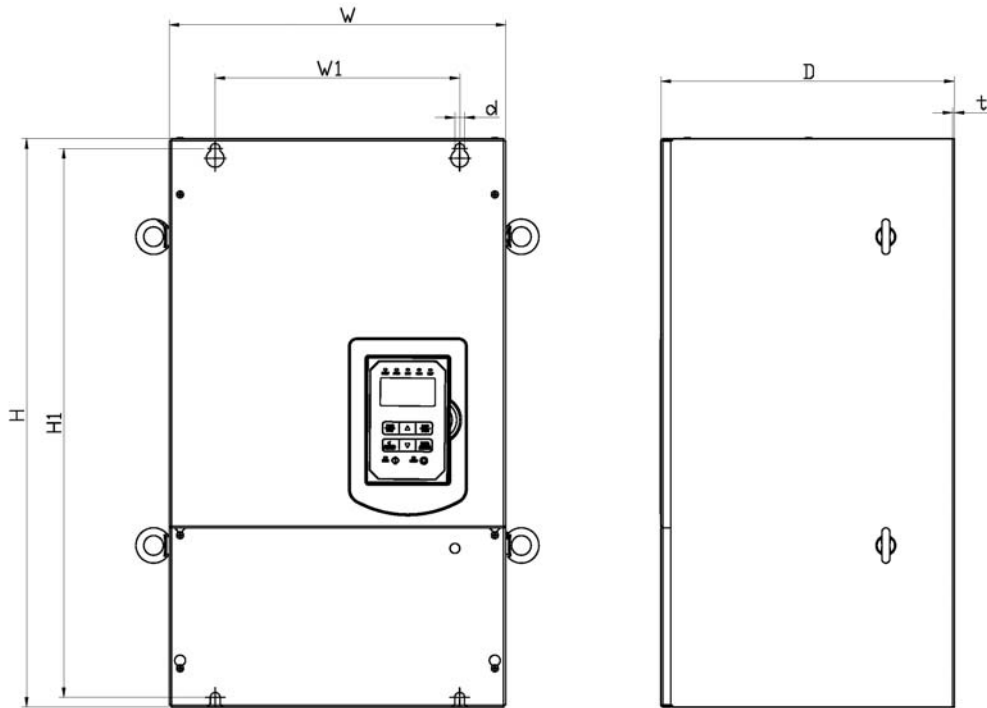

Inverter Model	Dimensions in mm (inch)							Net Weight in kg (lbs)
	W	H	D	W1	H1	t	d	
A510-2050-S□3	344 (13.54)	580 (22.83)	300 (11.81)	250 (9.84)	560 (22.05)	1.6 (0.06)	M8	40 (88.18)
A510-2060-S□3	344 (13.54)	580 (22.83)	300 (11.81)	250 (9.84)	560 (22.05)	1.6 (0.06)	M8	40 (88.18)
A510-2075-S□3	459 (18.07)	790 (31.10)	324.5 (12.78)	320 (12.60)	760 (29.92)	1.6 (0.06)	M10	74 (163.14)
A510-2100-S□3	459 (18.07)	790 (31.10)	324.5 (12.78)	320 (12.60)	760 (29.92)	1.6 (0.06)	M10	74 (163.14)
A510-4100-S□3	344 (13.54)	580 (22.83)	300 (11.81)	250 (9.84)	560 (22.05)	1.6 (0.06)	M8	40 (88.18)
A510-4125-S□3	344 (13.54)	580 (22.83)	300 (11.81)	250 (9.84)	560 (22.05)	1.6 (0.06)	M8	40 (88.18)
A510-4150-S□3	459 (18.07)	790 (31.10)	324.5 (12.78)	320 (12.60)	760 (29.92)	1.6 (0.06)	M10	74 (163.14)
A510-4175-S□3	459 (18.07)	790 (31.10)	324.5 (12.78)	320 (12.60)	760 (29.92)	1.6 (0.06)	M10	74 (163.14)
A510-4215-S□3	459 (18.07)	790 (31.10)	324.5 (12.78)	320 (12.60)	760 (29.92)	1.6 (0.06)	M10	74 (163.14)
A510-6100-S□3	344 (13.54)	580 (22.83)	300 (11.81)	250 (9.84)	560 (22.05)	1.6 (0.06)	M8	40 (88.18)

A510-6125-S□3	344 (13.54)	580 (22.83)	300 (11.81)	250 (9.84)	560 (22.05)	1.6 (0.06)	M8	40 (88.18)
A510-6150-S□3	344 (13.54)	580 (22.83)	300 (11.81)	250 (9.84)	560 (22.05)	1.6 (0.06)	M8	40 (88.18)
A510-6175-S□3	459 (18.07)	790 (31.10)	324.5 (12.78)	320 (12.60)	760 (29.92)	1.6 (0.06)	M10	74 (163.14)
A510-6215-S□3	459 (18.07)	790 (31.10)	324.5 (12.78)	320 (12.60)	760 (29.92)	1.6 (0.06)	M10	74 (163.14)
A510-6250-S□3	459 (18.07)	790 (31.10)	324.5 (12.78)	320 (12.60)	760 (29.92)	1.6 (0.06)	M10	74 (163.14)
A510-6270-S□3	459 (18.07)	790 (31.10)	324.5 (12.78)	320 (12.60)	760 (29.92)	1.6 (0.06)	M10	74 (163.14)

(d) 200V: 50 - 100HP / 400V: 100 - 215HP/ 690V: 100~270HP (IP20/ NEMA1)

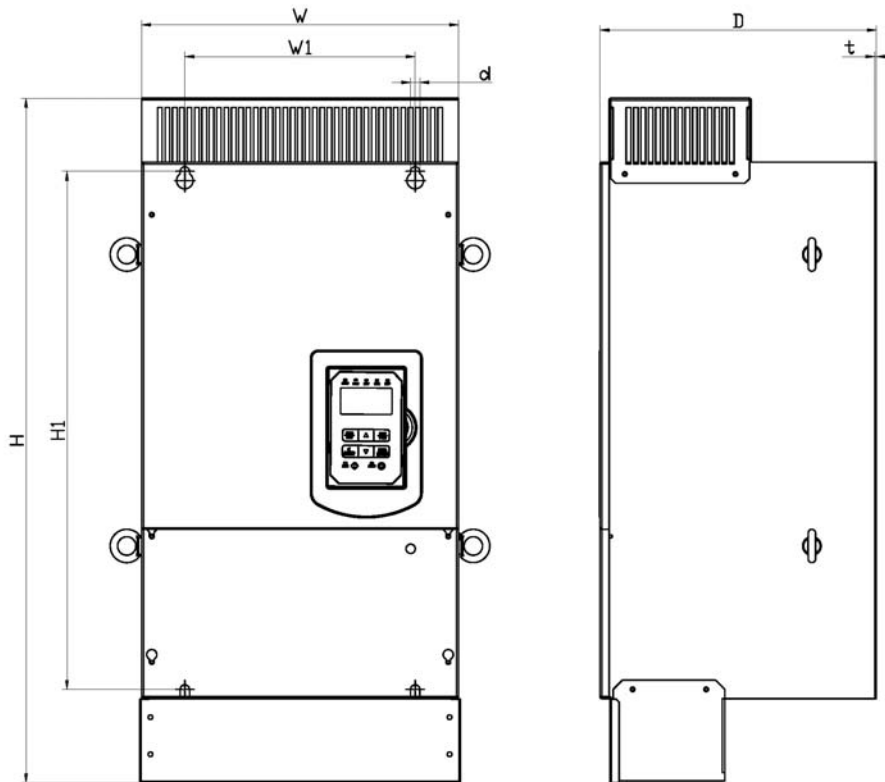

Inverter Model	Dimensions in mm (inch)							Net Weight in kg (lbs)
	W	H	D	W1	H1	t	d	
A510-2050-S□3	348.5 (13.72)	740 (29.13)	300 (11.81)	250 (9.84)	560 (22.05)	1.6 (0.06)	M8	44 (97.00)
A510-2060-S□3	348.5 (13.72)	740 (29.13)	300 (11.81)	250 (9.84)	560 (22.05)	1.6 (0.06)	M8	44 (97.00)
A510-2075-S□3	463.5 (18.25)	1105 (43.50)	324.5 (12.78)	320 (12.60)	760 (29.92)	1.6 (0.06)	M10	81 (178.57)
A510-2100-S□3	463.5 (18.25)	1105 (43.50)	324.5 (12.78)	320 (12.60)	760 (29.92)	1.6 (0.06)	M10	81 (178.57)
A510-4100-S□3	348.5 (13.72)	740 (29.13)	300 (11.81)	250 (9.84)	560 (22.05)	1.6 (0.06)	M8	44 (97.00)
A510-4125-S□3	348.5 (13.72)	740 (29.13)	300 (11.81)	250 (9.84)	560 (22.05)	1.6 (0.06)	M8	44 (97.00)
A510-4150-S□3	463.5 (18.25)	1105 (43.50)	324.5 (12.78)	320 (12.60)	760 (29.92)	1.6 (0.06)	M10	81 (178.57)
A510-4175-S□3	463.5 (18.25)	1105 (43.50)	324.5 (12.78)	320 (12.60)	760 (29.92)	1.6 (0.06)	M10	81 (178.57)
A510-4215-S□3	463.5 (18.25)	1105 (43.50)	324.5 (12.78)	320 (12.60)	760 (29.92)	1.6 (0.06)	M10	81 (178.57)
A510-6100-S□3	348.5 (13.72)	740 (29.13)	300 (11.81)	250 (9.84)	560 (22.05)	1.6 (0.06)	M8	44 (97.00)
A510-6125-S□3	348.5 (13.72)	740 (29.13)	300 (11.81)	250 (9.84)	560 (22.05)	1.6 (0.06)	M8	44 (97.00)
A510-6150-S□3	348.5 (13.72)	740 (29.13)	300 (11.81)	250 (9.84)	560 (22.05)	1.6 (0.06)	M8	44 (97.00)
A510-6175-S□3	463.5 (18.25)	1105 (43.50)	324.5 (12.78)	320 (12.60)	760 (29.92)	1.6 (0.06)	M10	81 (178.57)
A510-6215-S□3	463.5 (18.25)	1105 (43.50)	324.5 (12.78)	320 (12.60)	760 (29.92)	1.6 (0.06)	M10	81 (178.57)
A510-6250-S□3	463.5 (18.25)	1105 (43.50)	324.5 (12.78)	320 (12.60)	760 (29.92)	1.6 (0.06)	M10	81 (178.57)
A510-6270-S□3	463.5 (18.25)	1105 (43.50)	324.5 (12.78)	320 (12.60)	760 (29.92)	1.6 (0.06)	M10	81 (178.57)

(e) 200V: 125 - 150HP / 400V: 215H - 425HP (IP00)

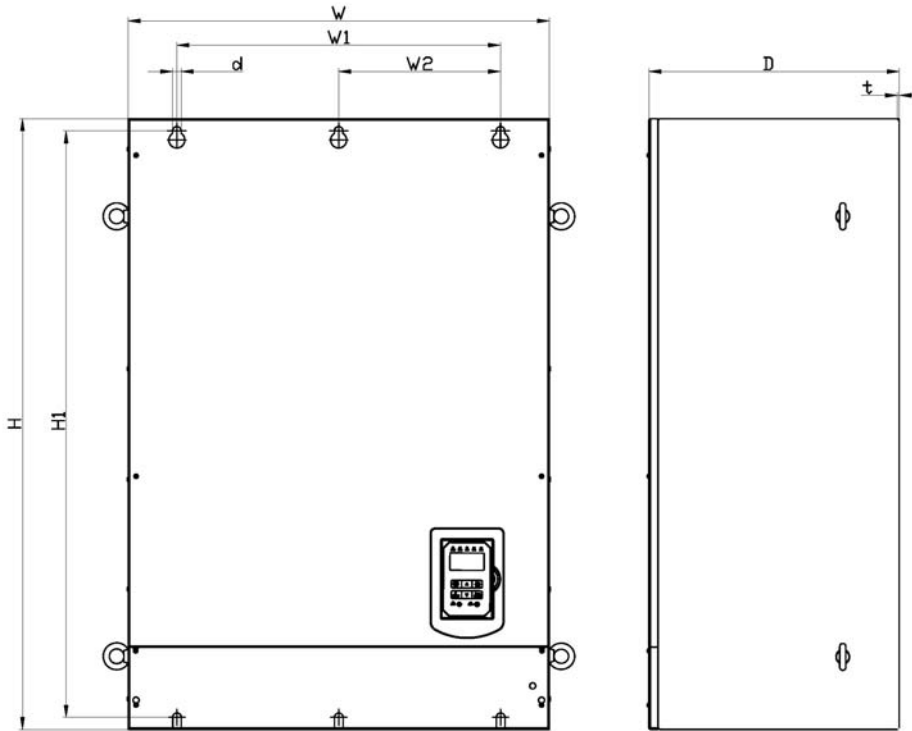

Inverter Model	Dimensions in mm (inch)								Net Weight in kg (lbs)
	W	H	D	W1	W2	H1	t	d	
A510-2125-S□3	690 (27.17)	1000 (39.37)	410 (16.14)	530 (20.87)	265 (10.43)	960 (37.80)	1.6 (0.06)	M12	184 (405.65)
A510-2150-S□3	690 (27.17)	1000 (39.37)	410 (16.14)	530 (20.87)	265 (10.43)	960 (37.80)	1.6 (0.06)	M12	184 (405.65)
A510-4270-S□3	690 (27.17)	1000 (39.37)	410 (16.14)	530 (20.87)	265 (10.43)	960 (37.80)	1.6 (0.06)	M12	184 (405.65)
A510-4300-S□3	690 (27.17)	1000 (39.37)	410 (16.14)	530 (20.87)	265 (10.43)	960 (37.80)	1.6 (0.06)	M12	184 (405.65)
A510-4375-S□3	690 (27.17)	1000 (39.37)	410 (16.14)	530 (20.87)	265 (10.43)	960 (37.80)	1.6 (0.06)	M12	184 (405.65)
A510-4425-S□3	690 (27.17)	1000 (39.37)	410 (16.14)	530 (20.87)	265 (10.43)	960 (37.80)	1.6 (0.06)	M12	184 (405.65)

(f) 200V: 125 - 150HP / 400V: 215H - 425HP (IP20/NEMA1)

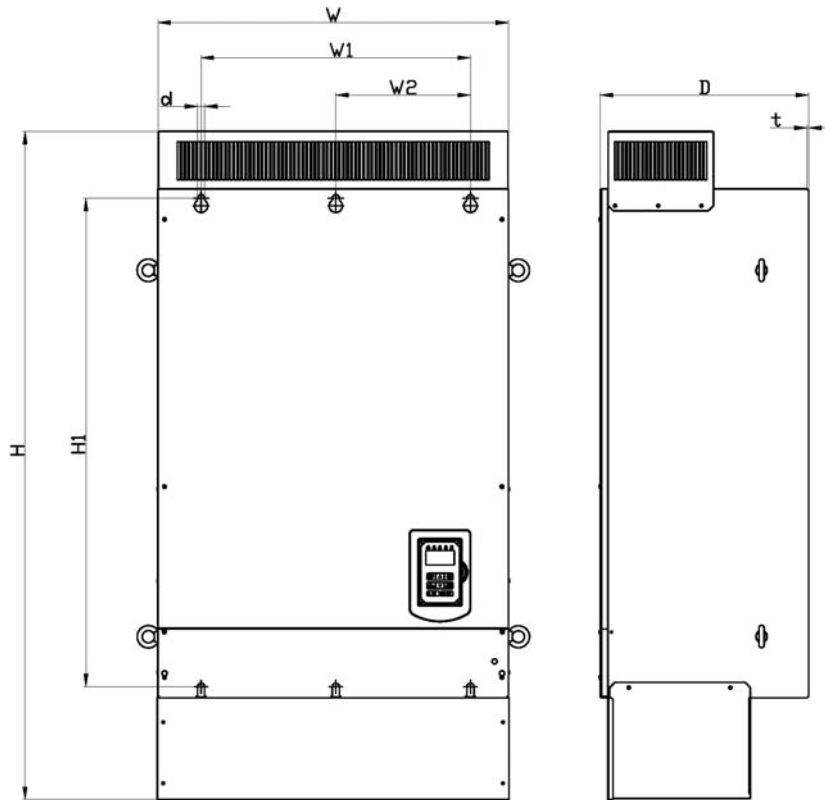

Inverter Model	Dimensions in mm (inch)								Net Weight in kg (lbs)
	W	H	D	W1	W2	H1	t	d	
A510-2125-S□3	692 (27.24)	1313 (51.69)	410 (16.14)	530 (20.87)	265 (10.43)	960 (37.80)	1.6 (0.06)	M12	194 (427.70)
A510-2150-S□3	692 (27.24)	1313 (51.69)	410 (16.14)	530 (20.87)	265 (10.43)	960 (37.80)	1.6 (0.06)	M12	194 (427.70)
A510-4270-S□3	692 (27.24)	1313 (51.69)	410 (16.14)	530 (20.87)	265 (10.43)	960 (37.80)	1.6 (0.06)	M12	194 (427.70)
A510-4300-S□3	692 (27.24)	1313 (51.69)	410 (16.14)	530 (20.87)	265 (10.43)	960 (37.80)	1.6 (0.06)	M12	194 (427.70)
A510-4375-S□3	692 (27.24)	1313 (51.69)	410 (16.14)	530 (20.87)	265 (10.43)	960 (37.80)	1.6 (0.06)	M12	194 (427.70)
A510-4425-S□3	692 (27.24)	1313 (51.69)	410 (16.14)	530 (20.87)	265 (10.43)	960 (37.80)	1.6 (0.06)	M12	194 (427.70)

### 3.22 Dimensions for Models with Built-in Filter

(a) 400V: 1 - 7.5HP

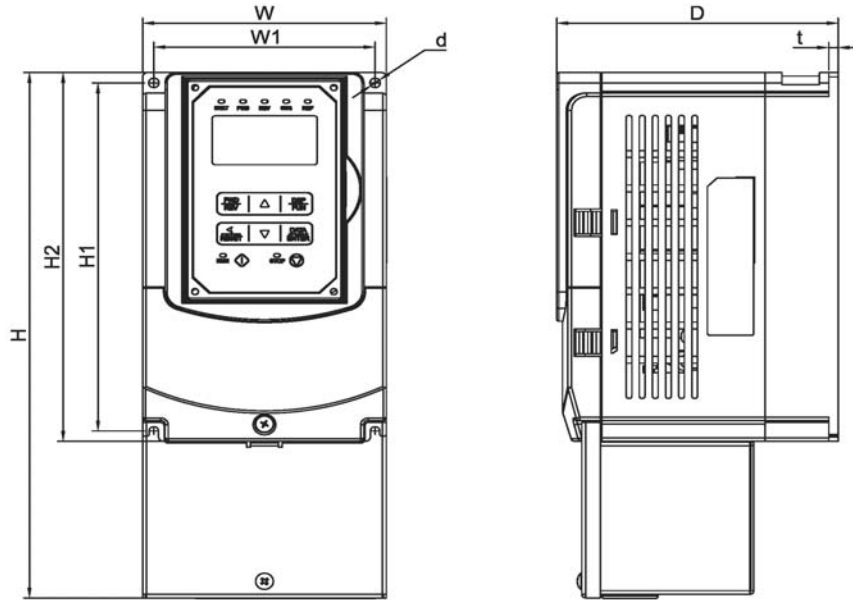

Inverter Model	Dimensions in mm (inch)								Net Weight in kg (lbs)
	W	H	D	W1	H1	H2	t	d	
A510-4001-S□3F	130 (5.12)	306 (12.05)	150 (5.91)	118 (4.65)	203 (7.99)	215 (8.46)	5 (0.20)	M5	3.5 (7.71)
A510-4002-S□3F	130 (5.12)	306 (12.05)	150 (5.91)	118 (4.65)	203 (7.99)	215 (8.46)	5 (0.20)	M5	3.5 (7.71)
A510-4003-S□3F	130 (5.12)	306 (12.05)	150 (5.91)	118 (4.65)	203 (7.99)	215 (8.46)	5 (0.20)	M5	3.5 (7.71)
A510-4005-S□3F	140 (5.51)	385.5 (15.18)	181 (7.13)	122 (4.80)	267 (10.51)	279 (10.98)	1.2 (0.05)	M6	5.5 (12.13)
A510-4008-S□3F	140 (5.51)	385.5 (15.18)	181 (7.13)	122 (4.80)	267 (10.51)	279 (10.98)	1.2 (0.05)	M6	5.5 (12.13)



**(b) 400V: 10 - 30HP**

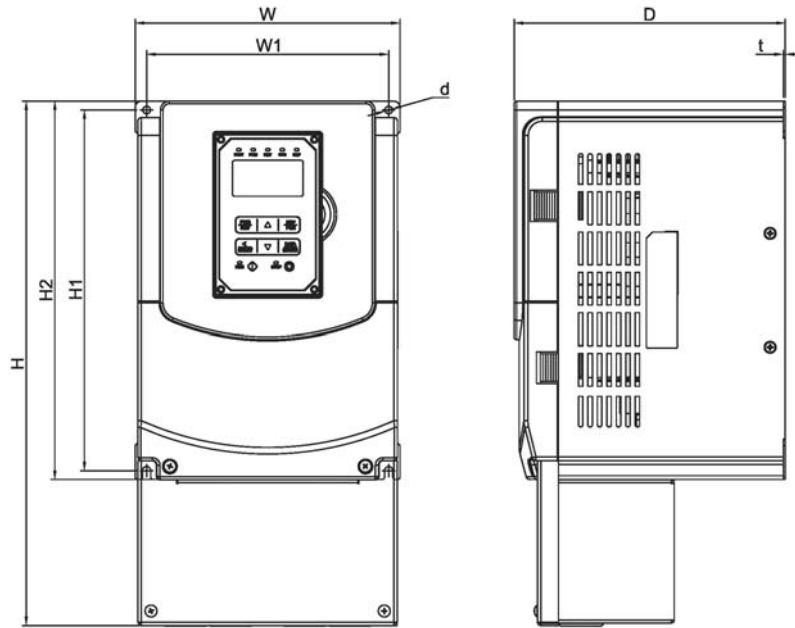

Inverter Model	Dimensions in mm (inch)								Net Weight in kg (lbs)
	W	H	D	W1	H1	H2	t	d	
A510-4010-S□3F	210 (8.27)	416.5 (16.40)	215 (8.46)	192 (7.56)	286 (11.26)	300 (11.81)	1.6 (0.06)	M6	8.0 (17.64)
A510-4015-S□3F	210 (8.27)	416.5 (16.40)	215 (8.46)	192 (7.56)	286 (11.26)	300 (11.81)	1.6 (0.06)	M6	8.0 (17.64)
A510-4020-S□3F	265 (10.43)	500 (19.69)	225 (8.86)	245 (9.65)	340 (13.39)	360 (14.17)	1.6 (0.06)	M8	12.5 (27.56)
A510-4025-S□3F	265 (10.43)	500 (19.69)	225 (8.86)	245 (9.65)	340 (13.39)	360 (14.17)	1.6 (0.06)	M8	12.5 (27.56)
A510-4030-S□3F	265 (10.43)	500 (19.69)	225 (8.86)	245 (9.65)	340 (13.39)	360 (14.17)	1.6 (0.06)	M8	12.5 (27.56)

(c) 400V: 40 - 60HP

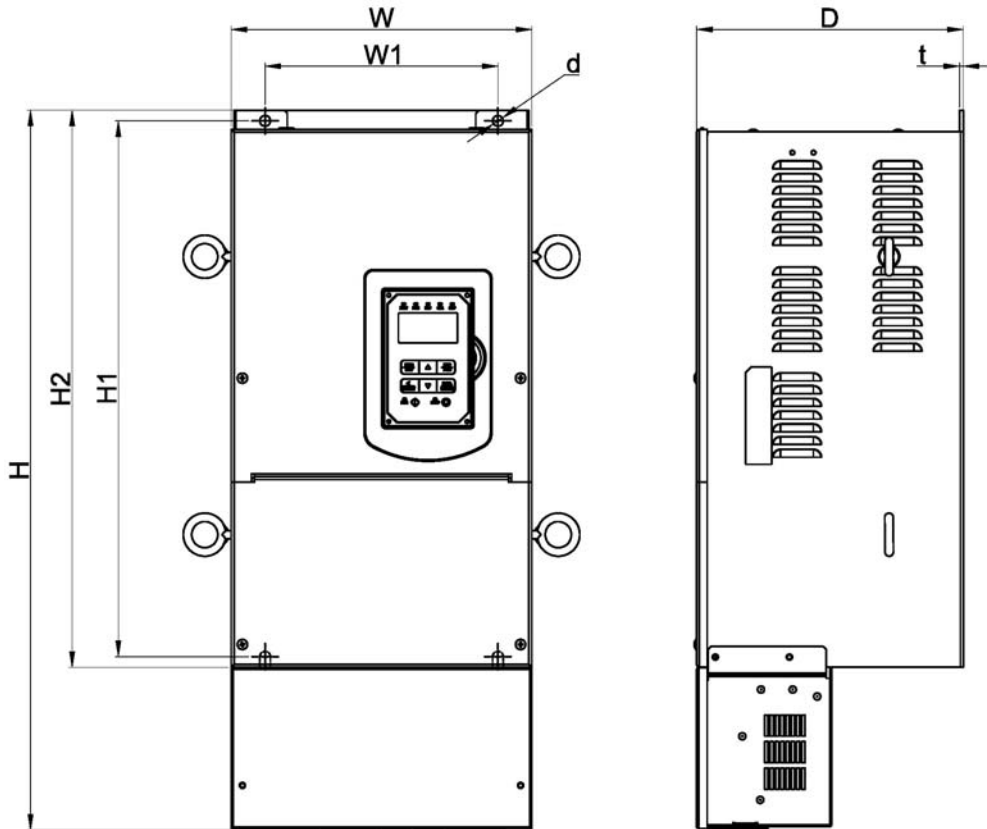

Inverter Model	Dimensions in mm (inch)								Net Weight in kg (lbs)
	W	H	D	W1	H1	H2	t	d	
A510-4040-S□3F	288 (11.34)	680 (26.77)	Note	160 (6.30)	505 (19.88)	525 (20.67)	3.3 (0.13)	M8	32 (70.55)
A510-4050-S□3F	288 (11.34)	680 (26.77)		160 (6.30)	505 (19.88)	525 (20.67)	3.3 (0.13)	M8	32 (70.55)
A510-4060-S□3F	288 (11.34)	680 (26.77)		160 (6.30)	505 (19.88)	525 (20.67)	3.3 (0.13)	M8	32 (70.55)
A510-4040-SE3F-B A510-4040-SG3F-B	286.5 (11.28)	680 (26.77)		252 (9.92)	160 (6.30)	505 (19.88)	525 (20.67)	3.3 (0.13)	M8

Note: Standard type is 252mm (9.92 inch), Enhanced type is 272mm (10.70 inch)

# Chapter 4 Keypad and Programming Functions

## 4.1 LED Keypad

### 4.1.1 Keypad Display and Keys

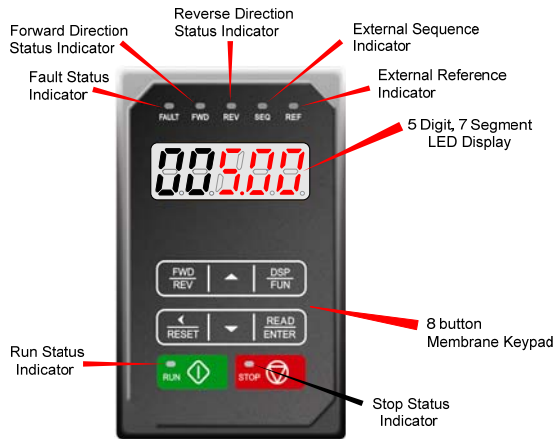

(Standard Type)

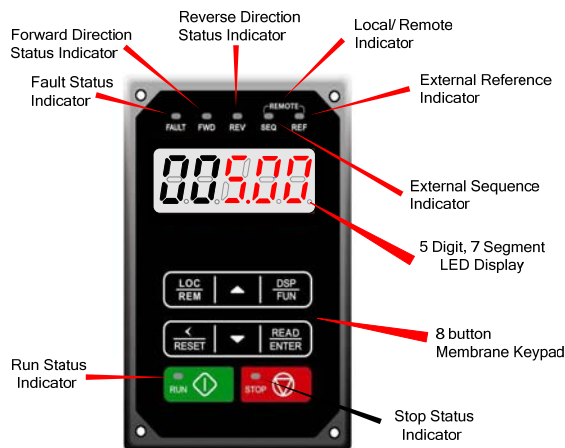

(Enhanced Type)

**Note: For Enhanced Type sold in the mainland, the last code of the inverter product is C, and the panel is the same as the Standard Type.**

DISPLAY	Description
<b>5 Digit LED Display</b>	Monitor inverter signals, view / edit parameters, fault / alarm display.
<b>LED INDICATORS</b>	
<b>FAULT</b>	LED <b>ON</b> when a fault or alarm is active.
<b>FWD</b>	LED <b>ON</b> when inverter is running in forward direction, flashing when stopping.
<b>REV</b>	On when inverter is running in reverse direction, flashing when stopping.

<b>SEQ</b>	LED <b>ON</b> when RUN command is from the external control terminals or from serial communication
<b>REF</b>	LED <b>ON</b> when Frequency Reference command is from the external control terminals or from serial communication

<b>KEYS (8)</b>	<b>Description</b>
<b>RUN</b>	RUN Inverter in Local Mode
<b>STOP</b>	STOP Inverter
<b>▲</b>	Parameter navigation Up, Increase parameter or reference value
<b>▼</b>	Parameter navigation down, decrease parameter or reference value
<b>FWD/REV (Standard Type)</b>	Used to switch between Forward and Reverse direction
<b>LOC/REM (Enhanced Type)</b>	Used to switch between Local Mode and Remote Mode REMOTE Mode: Set by parameters, controlled by control circuit terminals, communication or other ways. LOCAL Mode: Controlled by operator. It displays REMOTE Mode at power-up. Users can switch between LOCAL and REMOTE Mode if they press LOC/ REM keys when the inverter stops. Parameter of 11-79 can determine if LOC/REM keys are enabled or not.
<b>DSP/FUN</b>	Used to scroll to next screen Frequency screen →Function selection→Monitor parameter
<b>◀ / RESET</b>	Selects active seven segment digit for editing with the ▲ ▼ keys Used to reset fault condition.
<b>READ / ENTER</b>	Used to read and save the value of the active parameter

#### **Auto-Repeat Keys**

Holding the ▲UP or ▼DOWN key for a longer period of time will initiate the auto-repeat function resulting in the value of the selected digit to automatically increase or decrease.

### 4.1.2 Seven Segment Display Description

Actual	LED Display	Actual	LED Display	Actual	LED Display	Actual	LED Display
0		A		L		Y	
1		B		n		-	
2		C		o		°	
3		D		P		_	
4		E		q		.	
5		F		r			
6		G		S			
7		H		t			
8		I		u			
9		J		v			









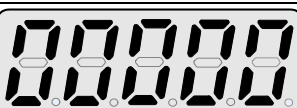

Display output frequency LED lights on	Frequency Reference LED flashes	Set Frequency Reference Flashing digit

◆ At power-up, the display will show the frequency reference setting and all LEDs are flashing. Press the ▲ (UP) or ▼ (DOWN) key to enter the frequency reference edit mode, use the ◀/RESET key to select which digit to edit (flashing). Use the ▲ (UP) or ▼ (DOWN) key to modify the value and press the READ / ENTER key to save the frequency reference and switch back to the frequency reference display mode.

◆ During run operation, the display will show the output frequency.

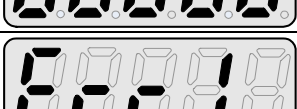

**Note:** When in edit mode and the READ / ENTER is not pressed within 5 sec, the inverter will switch back to the frequency reference display mode.

## LED Display Examples



Seven Segment Display	Description
	1. Displays the frequency reference at power-up. 2. Displays the actual output frequency during run operation.
	Displays parameter code.
	Displays the setting value of parameter.
	Displays input voltage.
	Displays inverter current.
	Displays DC Bus Voltage.
	Displays temperature.
	Displays PID feedback value; The displayed digit is set by 12-01.
	Error display; refer to chapter 5 Troubleshooting and Maintenance.
	Displays AI1/ AI2 input (0~100%)

### 4.1.3 LED Indicator Description



- **Fault LED**

State	Description	FAULT LED
Off	No Fault Active	
Illuminated	Fault Active	



- **Forward LED**

State	Description	FWD LED
Off	Inverter in reverse direction	
Illuminated	Inverter is running in forward direction	
Flashing	Forward direction active, no run command	



- **Reverse LED**

State	Description	REV LED
Off	Inverter in forward direction	
Illuminated	Inverter is running in reverse direction	
Flashing	Reverse direction active, no run command	



- **RUN LED**

State	Description	RUN LED
Off	Inverter stopped	
Illuminated	Inverter running	
Flashing	Inverter stopped or stopping	

● **SEQ LED**

State	Description	SEQ LED
Off	Sequence controlled from keypad	
Illuminated	Sequence set from external source	

● **REF LED**

State	Description	REF LED
Off	Frequency reference set from keypad	
Illuminated	Frequency reference set from external source	

**Run / Stop Status Indicators**

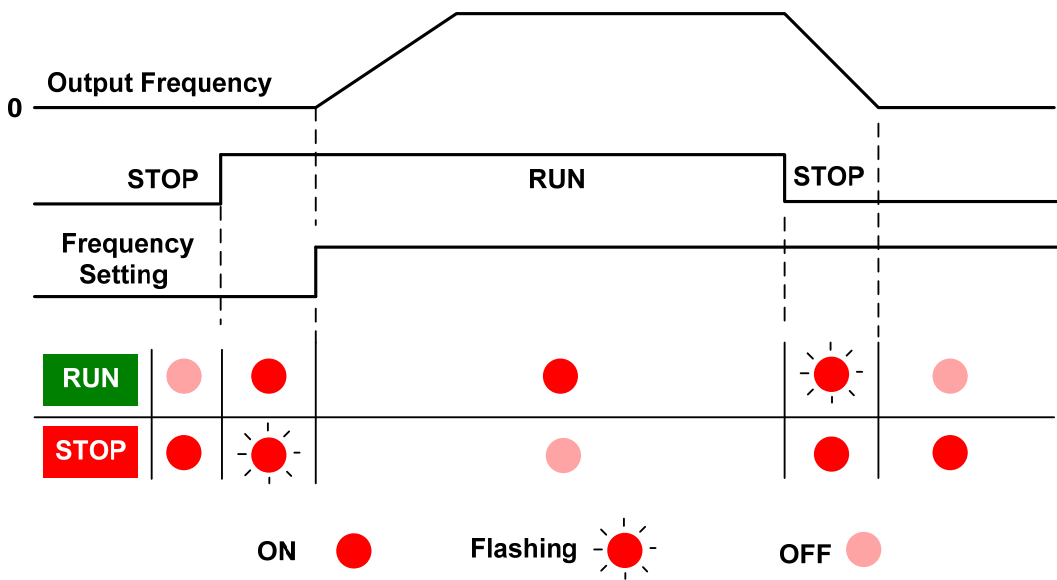



## 4.1.4 Power-up Monitor

### ◆ Power-up

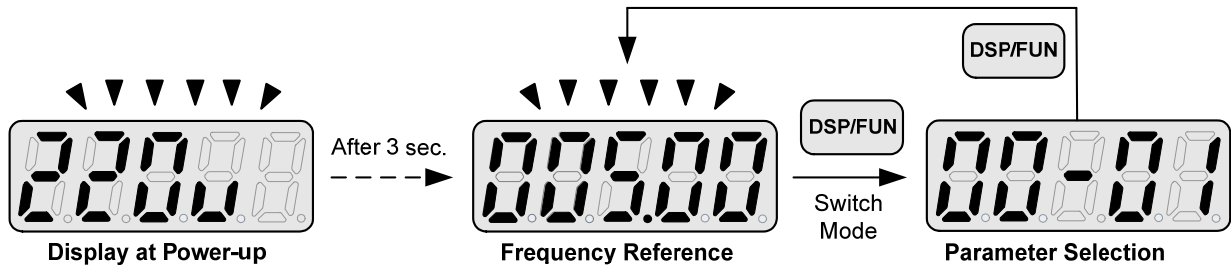

### ◆ Changing Monitor at Power-up

12- 00	Display Selection							
Range	Highest bit -> 0 0 0 0 0 <- Lowest bit The setting range for each bit is 0 ~ 7 from the highest bit to the lowest bit.							
	<table border="0"> <tr> <td>0: No display</td> <td>4: Temperature</td> </tr> <tr> <td>1: Output current</td> <td>5: PID feedback</td> </tr> <tr> <td>2: Output voltage</td> <td>6: AI1 value</td> </tr> <tr> <td>3: DC voltage</td> <td>7: AI2 value</td> </tr> </table>	0: No display	4: Temperature	1: Output current	5: PID feedback	2: Output voltage	6: AI1 value	3: DC voltage
0: No display	4: Temperature							
1: Output current	5: PID feedback							
2: Output voltage	6: AI1 value							
3: DC voltage	7: AI2 value							

Example: 12- 00= 【10000】

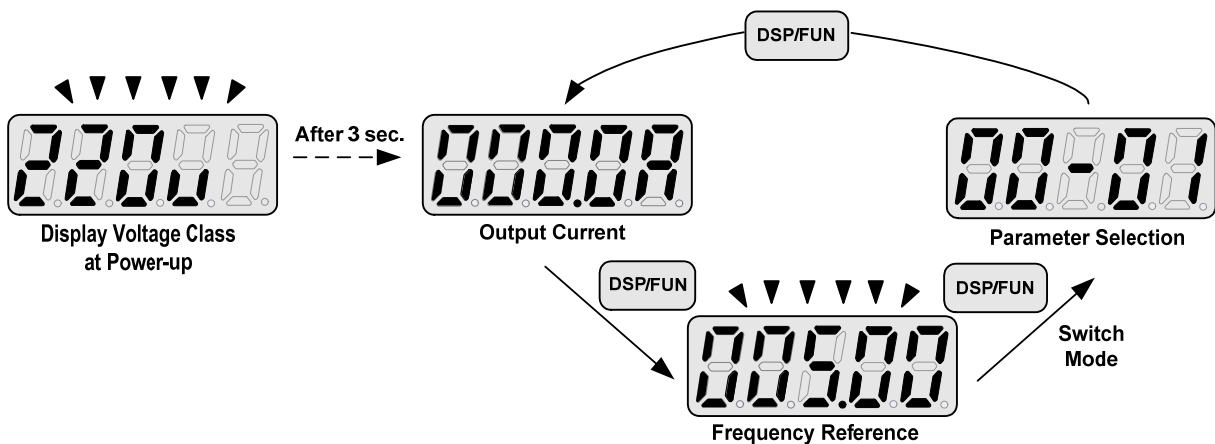

Example: 12- 00= 【12345】

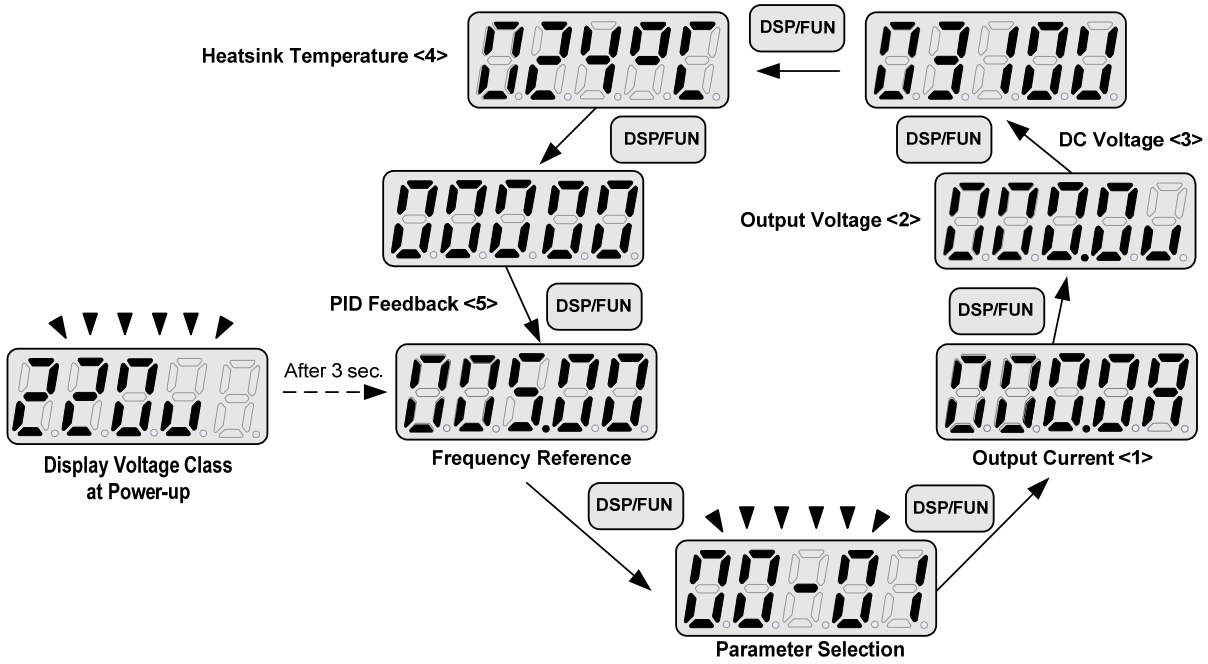

### 4.1.5 Modifying Parameters/ Set Frequency Reference

Example: Modifying Parameters

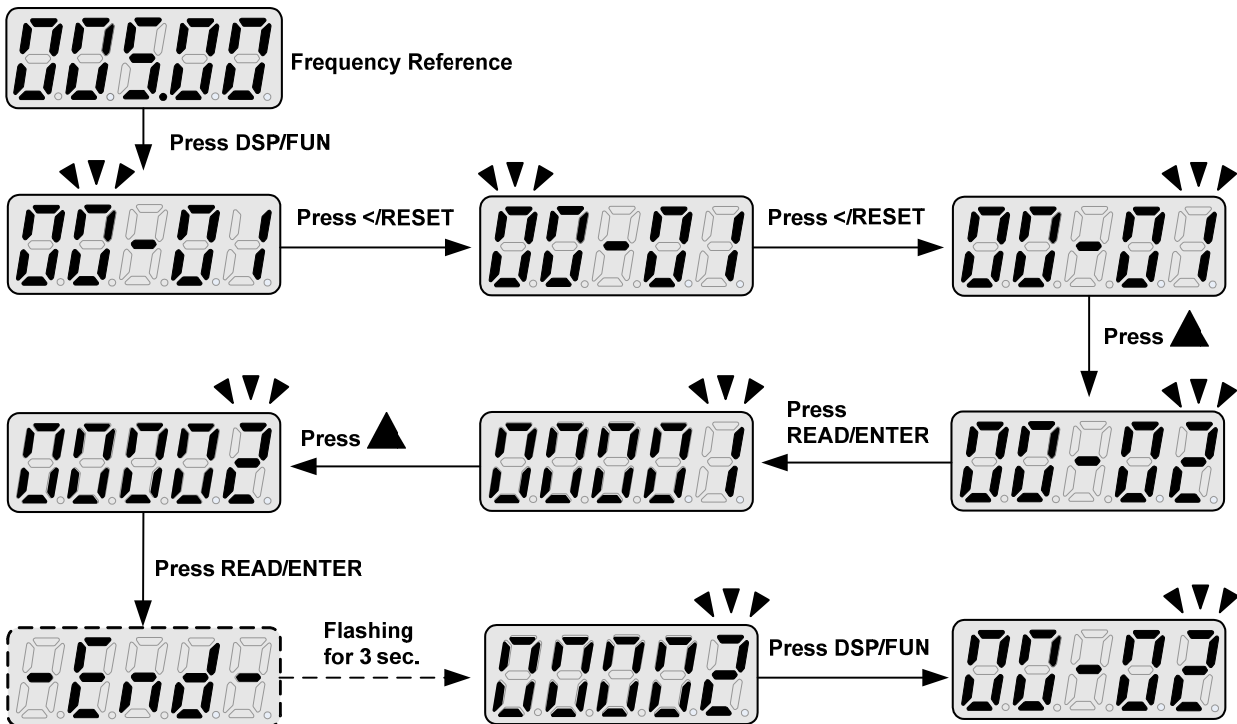

## Example: Set Frequency Reference

**Inverter stopped:**

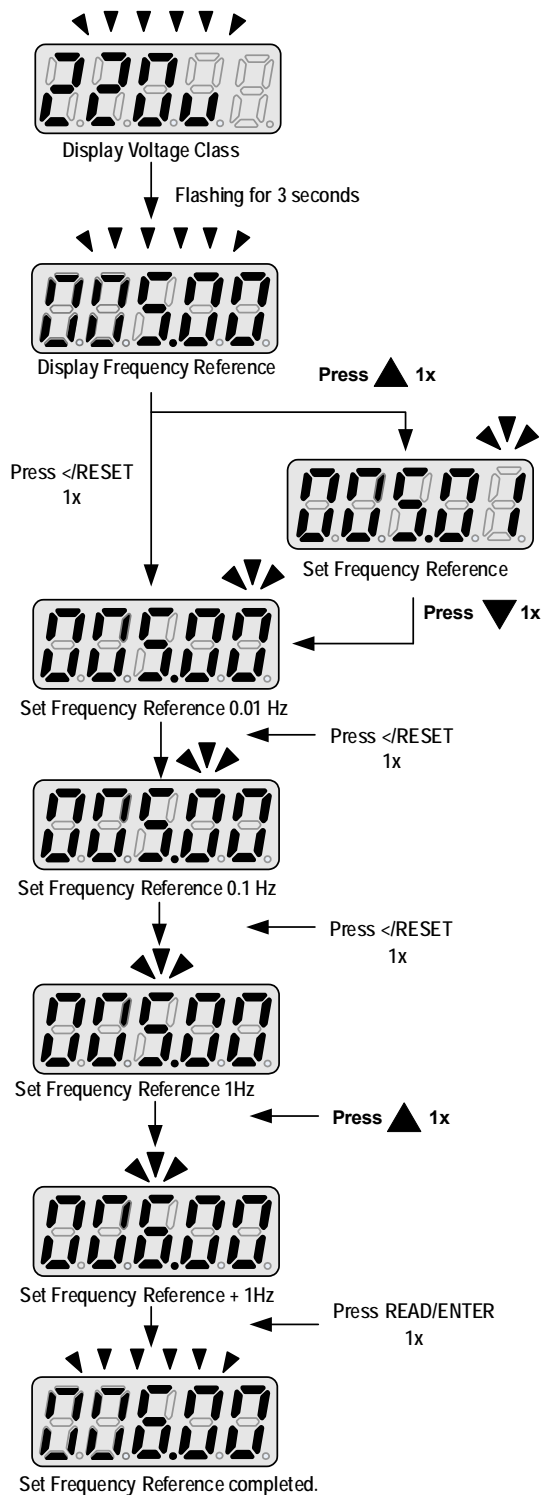

**Inverter is running:**

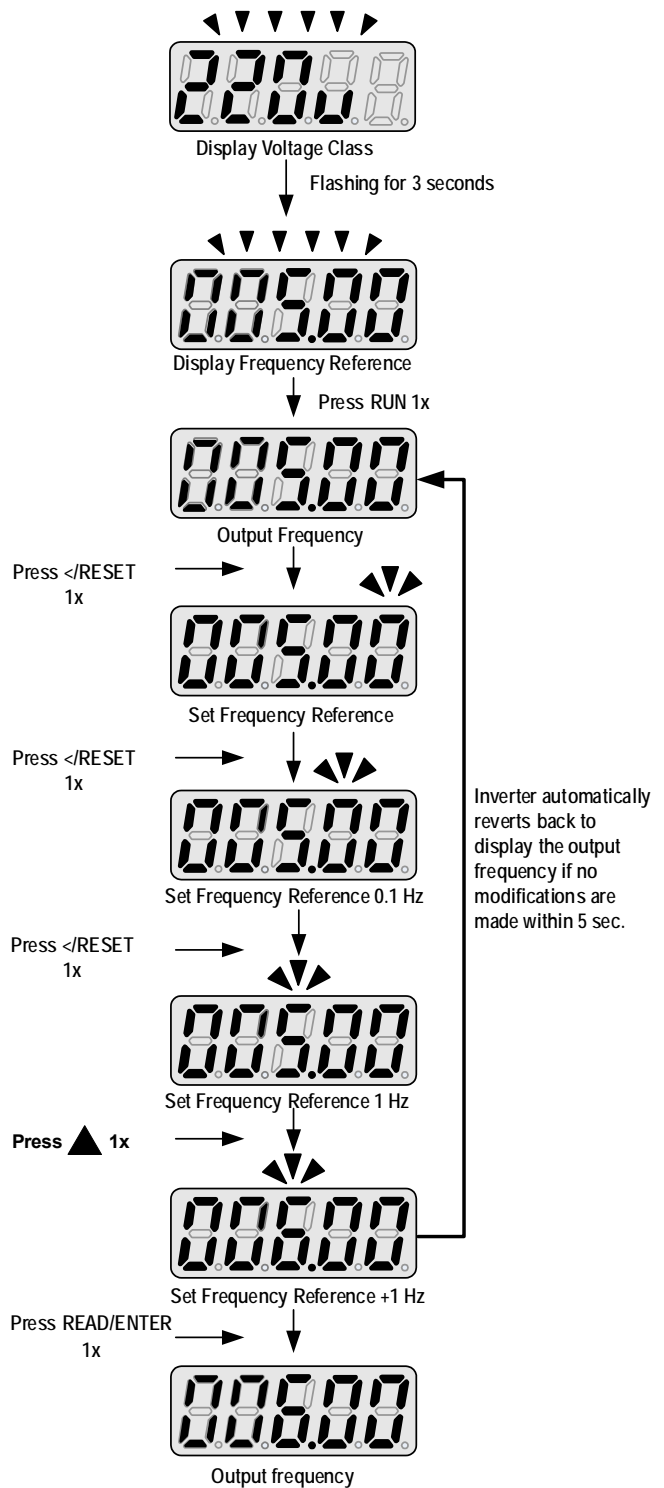

**Note:** When upper or lower limit is reached during editing of the frequency reference, the edit value will automatically rollover from the lower limit to the upper limit or from the upper limit to the lower limit.

### 4.1.6 Operation Control

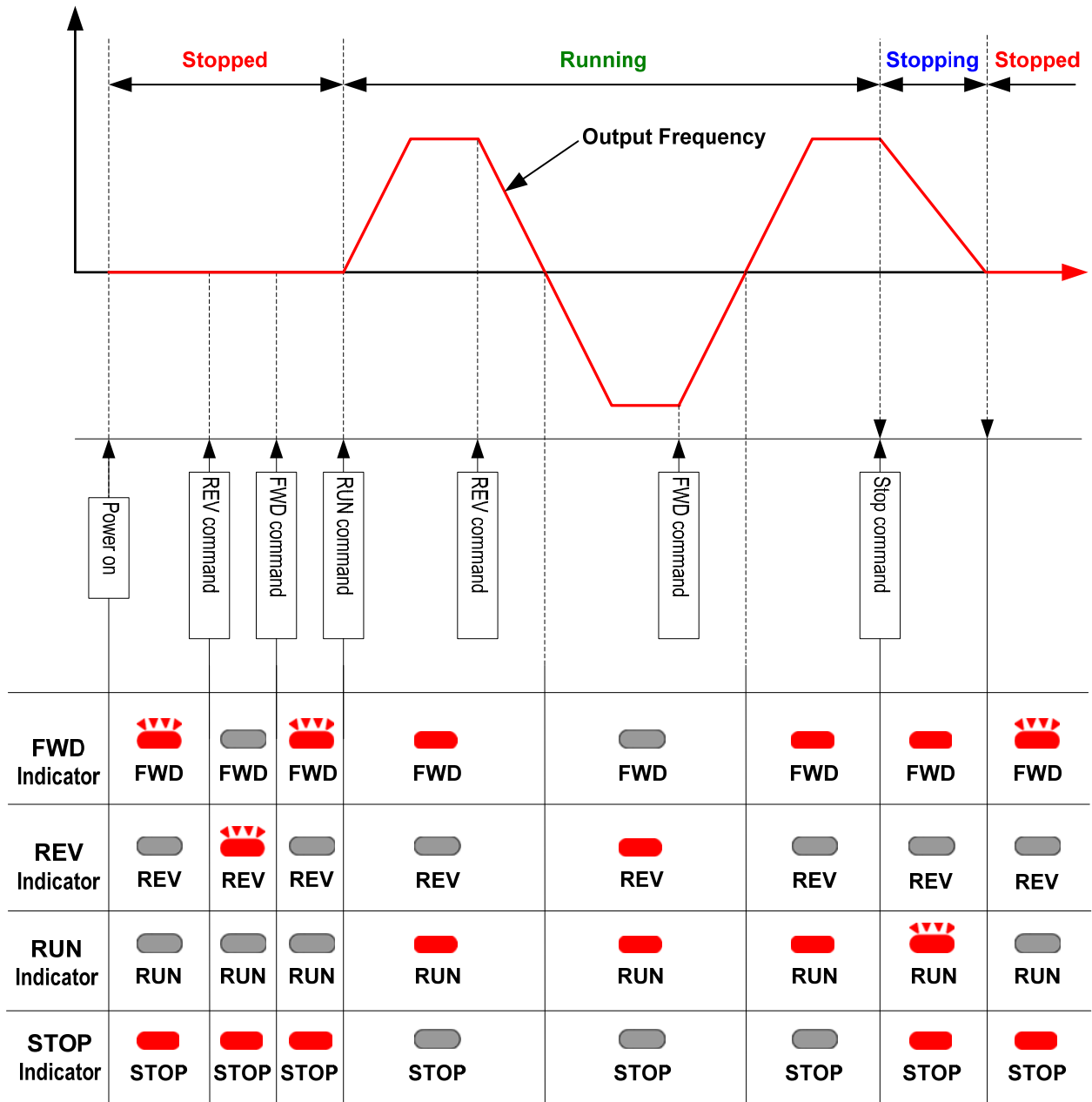

## 4.2 LCD Keypad

### 4.2.1 Keypad Display and Keys



(Standard Type)

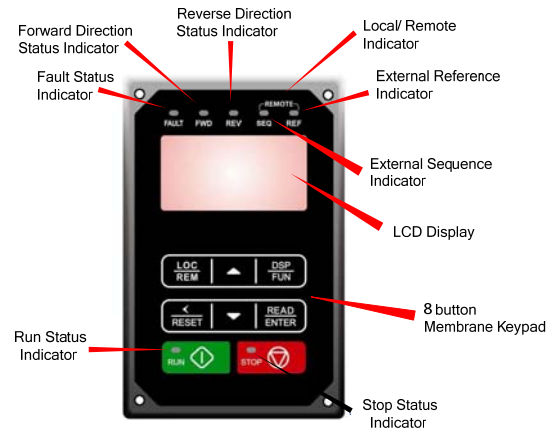

(Enhanced Type)

DISPLAY	Description
LCD Display	Monitor inverter signals, view / edit parameters, fault / alarm display.
<b>LED INDICATORS</b>	
FAULT	LED ON when a fault or alarm is active.
FWD	LED ON when inverter is running in forward direction, flashing when stopping.
REV	On when inverter is running in reverse direction, flashing when stopping.
SEQ	LED ON when RUN command is from the external control terminals or from serial communication
REF	LED ON when Frequency Reference command is from the external control terminals or from serial communication

<b>KEYS (8)</b>	<b>Description</b>
<b>RUN</b>	RUN Inverter in Local Mode
<b>STOP</b>	STOP Inverter
<b>▲</b>	Parameter navigation Up, Increase parameter or reference value
<b>▼</b>	Parameter navigation down, decrease parameter or reference value
<b>FWD/REV (Standard Type)</b>	Used to switch between Forward and Reverse direction
<b>LOC/REM (Enhanced Type)</b>	Used to switch between Local Mode and Remote Mode REMOTE Mode: Set by parameters, controlled by control circuit terminals, communication or other ways. LOCAL Mode: Controlled by operator. It displays REMOTE Mode at power-up. Users can switch between LOCAL and REMOTE Mode if they press LOC/ REM keys when the inverter stops. Parameter of 23-41 can determine if LOC/REM keys are enabled or not.
<b>DSP/FUN</b>	Used to scroll to next screen Frequency screen →Function selection→Monitor parameter
<b>◀ / RESET</b>	Selects active seven segment digit for editing with the ▲ ▼ keys Used to reset fault condition.
<b>READ / ENTER</b>	Used to read and save the value of the active parameter

#### **Auto-Repeat Keys**

Holding the ▲UP or ▼DOWN key for a longer period of time will initiate the auto-repeat function resulting in the value of the selected digit to automatically increase or decrease.

## 4.2.2 Keypad Menu Structure

### Main Menu

The A510S inverter main menu consists of two main groups (modes). The DSP/FUN key is used to switch between the monitor mode and the parameter group mode.

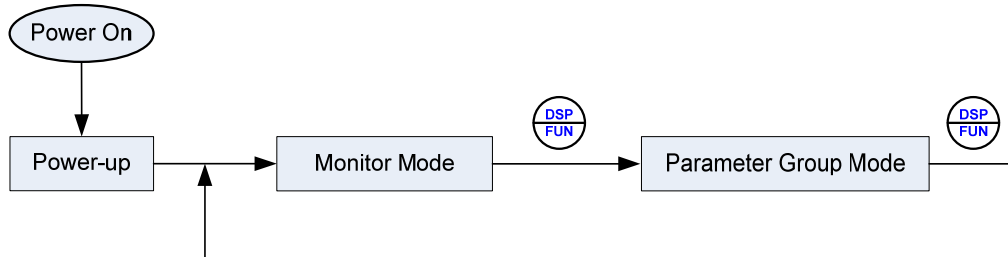

Mode	Description
Monitor Mode	View inverter status, signals and fault data.
Parameter Group Mode	Access to available parameter groups.

All the available parameter groups are listed in the Parameter Group Mode use the up and down keys to select a group and press Read/Enter key to access its parameters.

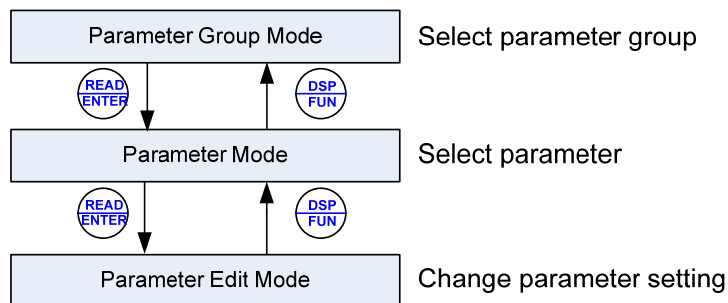

**Fig. 4.2.2.1 Parameter Group Structure**

#### Notes:

- Always perform an auto-tune on the motor before operating the inverter in vector control (sensorless vector or flux vector). Auto-tuning mode will not be displayed when the inverter is running or when a fault is active.
- To scroll through the available modes, parameter groups or parameter list press and hold the up or down key.

## Monitor Mode

In monitor mode inverter signals can be monitored such as output frequency, output current and output voltage, etc...) as well as fault information and fault trace. See Fig 4.2.2.2 for keypad navigation.

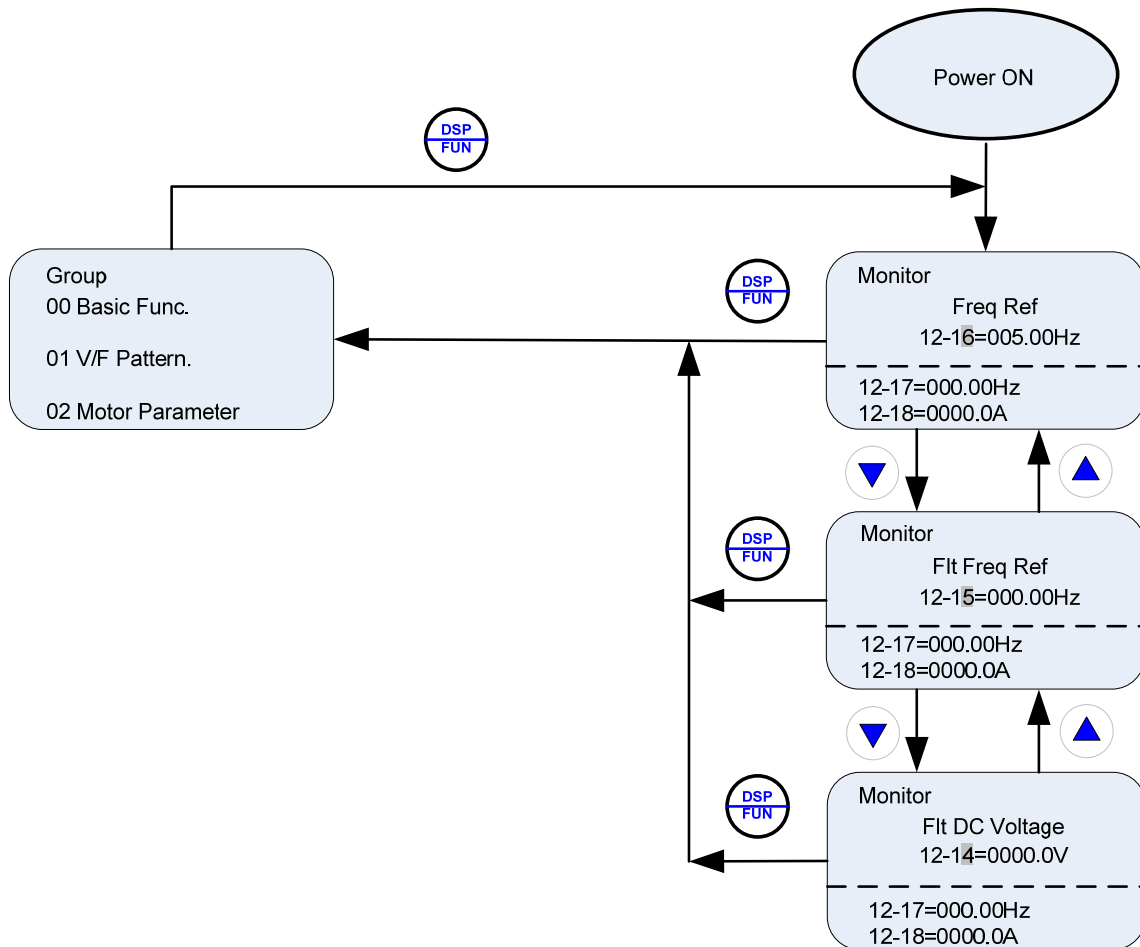

Fig 4.2.2.2 Monitor Mode

**Note:**

- To scroll through the available monitor parameter list, press and hold the ▲ (up) or ▼ (down) key.



## Programming Mode

In programming mode inverter parameters can be read or changed. See Fig 4.2.2.3 for keypad navigation.

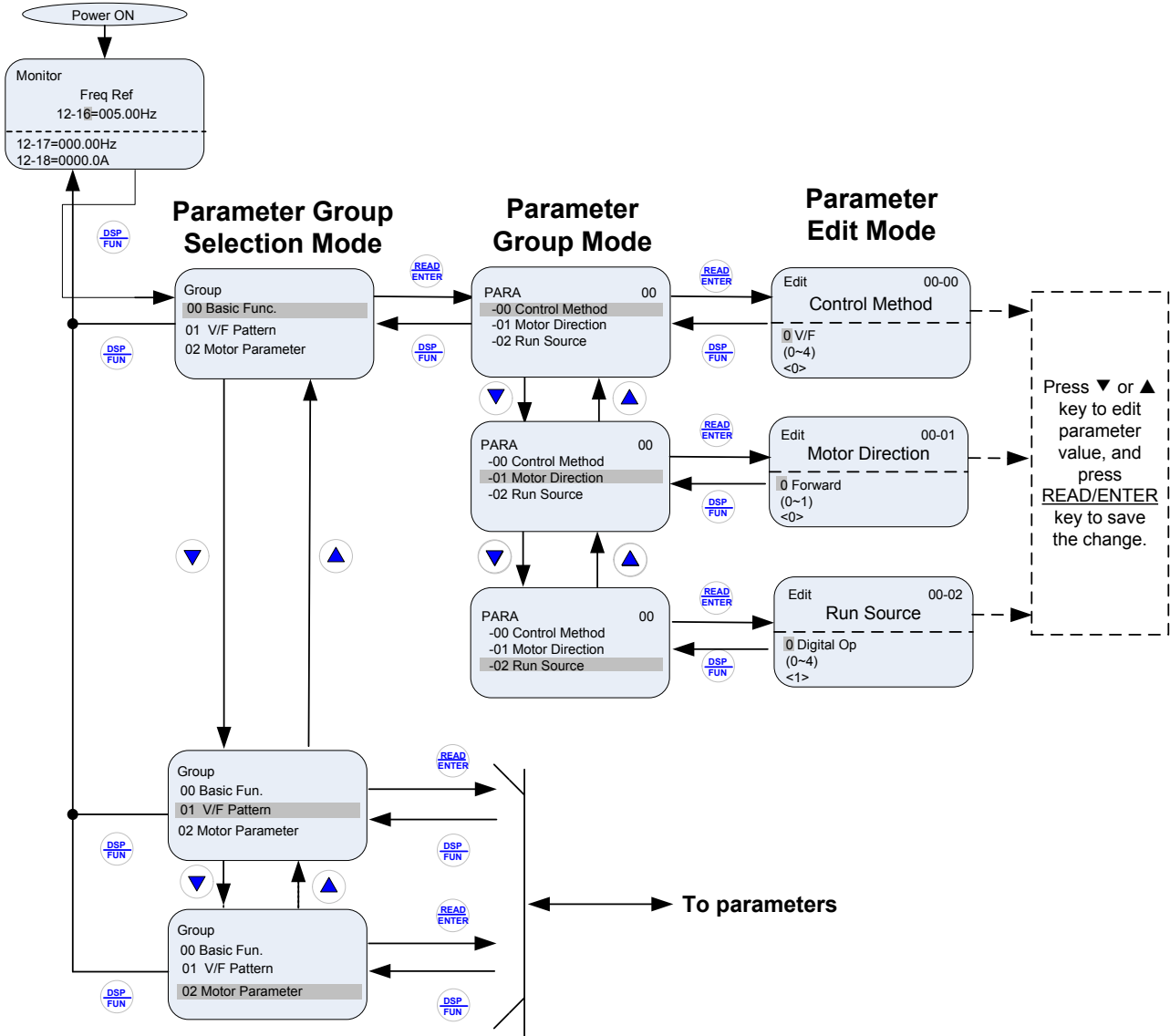

Fig 4.2.2.3 Programming Mode

### Notes:

- The parameters values can be changed from the Edit screen with the up, down and < / RESET shift key.
- To save a parameter press the READ/ENTER key.
- Refer to section 4.4 for parameter details.
- Press the ▲ (up) or ▼ (down) key to scroll parameter groups or parameter list.

## Auto-tuning Mode

In the auto-tuning mode motor parameters can be calculated and set automatically based on the selected control mode. See Fig 4.2.2.4 for keypad navigation.

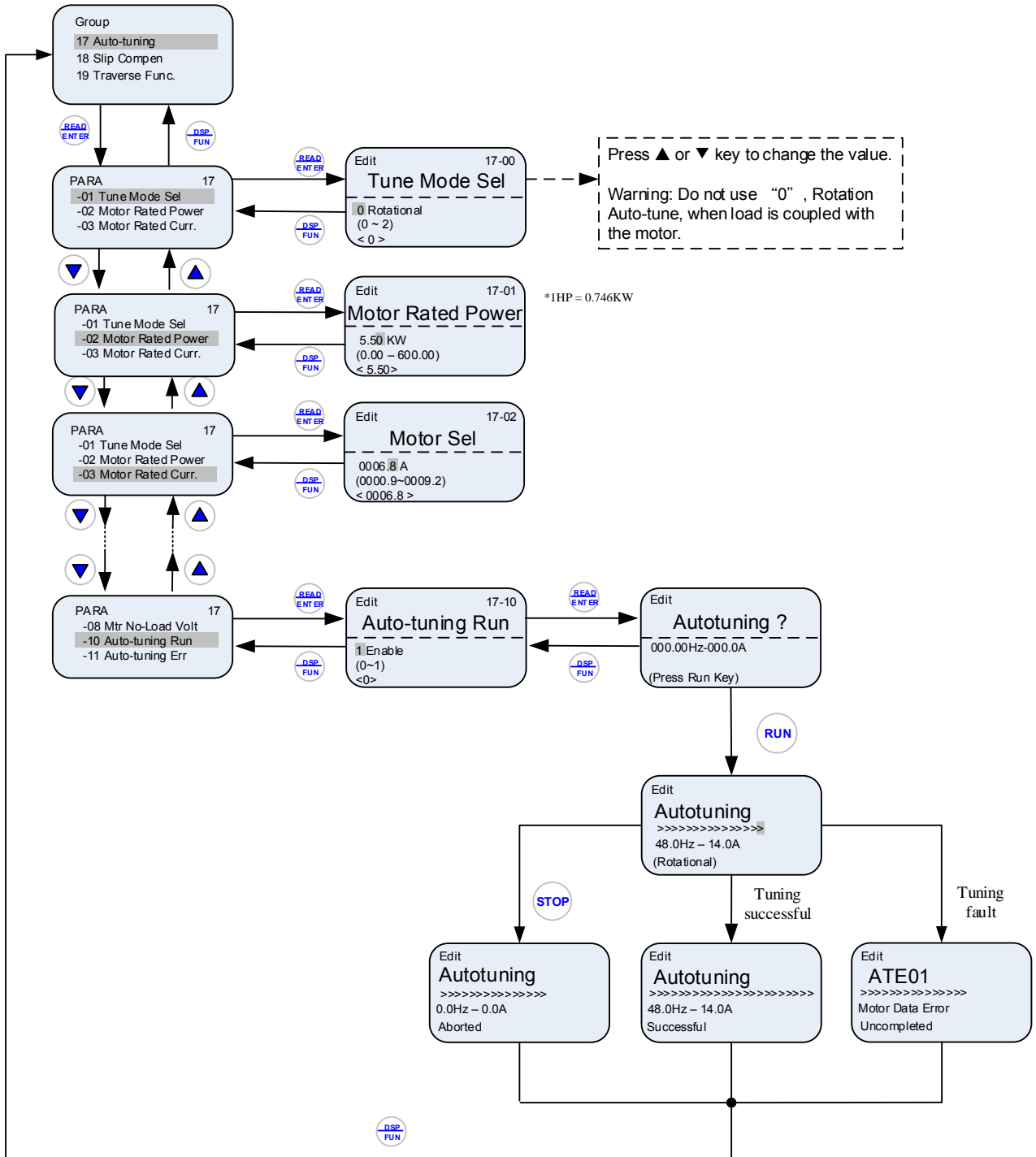

Fig 4.2.2.4 Auto-tuning Mode

### Notes:

- Set correct motor parameters by referring to motor nameplate.
- Refer to section 4.4 for parameter details.

#### 4.2.2 Notes:

1. Use the up and down keys to scroll through the auto-tuning parameter list. Depending on the selected control mode in parameter 00-00, part of auto-tuning parameters will not be accessible. (Refer to the Auto-tuning Group 17 parameters).
2. After entering the motor nameplate rated output power (17-01), rated current (17-02), rated voltage (17-03), rated frequency (17-04), rated speed (17-05) and number of motor poles (17-06), select the automatic tuning mode and press the RUN key to perform the auto-tuning operation. When auto-tuning is successful the calculated motor parameters will be saved into parameter group 02 (motor parameter).
3. (a) "Rotational" will be displayed during rotational auto-tuning (17-00=0) and the motor will rotate during auto-tuning. Ensure that it is safe to operate the motor before pressing the RUN key.  
(b) "Stationary" will be displayed during stationary auto-tuning (17-00=1), the motor shaft does not rotate.  
(c) "R1 Tuning" will be displayed during stationary auto-tuning (17-00=2), the motor shaft does not rotate.  
(d) The RUN LED (in the upper left corner of the RUN key) will be lit during auto-tuning.  
(e) The LCD display shows ">>>" or "Atund" during the auto-tuning process.
4. Press the STOP key on the keypad to abort the auto-tuning operation.
5. In case of an auto-tuning fault, a fault message and the uncompleted message are displayed on the keypad. The RUN LED will be flashing and the motor will coast to stop. (Refer to section 10.4 for the Auto-tuning Faults.) The auto-tuning fault can be cleared by pressing the RESET key after which the keypad displays the auto-tuning mode again.

All motor parameters (group 02 through group 17 parameters) will revert back to their factory settings if a fault occurs. The motor data must be entered again before re-starting auto-tuning. The keypad shows ">>>" during an auto-tuning fault.

6. Upon successful completion of an auto-tune, the RUN LED will turn off. Press the DSP/FUN key to return to the main menu to select the next operation. The auto-tuning procedure takes approximately 50 seconds.

## 4.3 Parameters

Parameter group	Group Name
Group 00	Basic Parameters
Group 01	V/F Control Parameters
Group 02	IM Motor Parameters
Group 03	External Digital Input and Output Parameters
Group 04	External Analog Input and Output Parameters
Group 05	Multi-Speed Parameters
Group 06	Automatic Program Operation Parameters
Group 07	Start /Stop Parameters
Group 08	Protection Parameters
Group 09	Communication Parameters
Group 10	PID Parameters
Group 11	Auxiliary Parameters
Group 12	Monitoring Parameters
Group 13	Maintenance Parameters
Group 14	PLC Parameters
Group 15	PLC Monitoring Parameters
Group 16	LCD Parameters
Group 17	Automatic Tuning Parameters
Group 18	Slip Compensation Parameters
Group 19	Wobble Frequency Parameters
Group 20	Speed Control Parameters
Group 21	Torque And Position Control Parameters
Group 22	PM Motor Parameters

Parameter Attribute		
*1	Parameters can be changed during run operation	<b>Note1:</b> New added or modified parameters in software V1.02 <b>Note2:</b> New added or modified parameters in software V1.10 <b>Note3:</b> New added or modified parameters in software V1.20 <b>Note4:</b> New added or modified parameters in software V1.30 <b>Note5:</b> New added or displayed parameters in software V1.30, when 00-32=8 <b>Note6:</b> Parameter edit available for software V1.30 above <b>Note7:</b> New added or modified parameters in software V1.41 <b>Note8:</b> New added or modified parameters in software V1.42
*2	Reserved	
*3	Parameter will not reset to default during a factory reset (initialization).	
*4	Read-only parameter	
*5	Parameter will be displayed in being coupled with the option card	
*6	Parameter will be displayed only in LED keypad	
*7	Parameter will be displayed only in LCD keypad	
*8	When 13-08 setting is changed, the value will be also changed	
*9	For enhanced E type & G type only	
*10	Only available after I/O expansion card installed	

**Group 00: Basic Parameters**

Code	Parameter Name	Setting Range	Default	Unit	Control mode						Attribute	
					V/F	V/F+PG	SLV	SV	PM SV	PM SLV		SLV2
00-00	Control Mode Selection	0: V/F	0	-	0	0	0	0	0	0	0	*3
		1: V/F+PG										
		2: SLV										
		3: SV										
		4: PMSV										
		5: PMSLV										
6: SLV2												
00-01	Motor's Rotation Direction	0: Forward	0	-	0	0	0	0	0	0	0	*1
		1: Reverse										
00-02	Main Run Command Source Selection	0: Keypad	1	-	0	0	0	0	0	0	0	
		1: External Terminal (Control Circuit)										
		2: Communication Control (RS-485)										
		3: PLC										
4: RTC <small>Note8</small>												
00-03	Alternative Run Command Selection	0: Keypad	0 (Note4)	-	0	0	0	0	0	0	0	
		1: External Terminal (Control Circuit)										
		2: Communication Control (RS-485)										
		3: PLC										
4: RTC <small>Note8</small>												
00-04	Language	0: English	0	-	0	0	0	0	0	0	0	*7
		1: Simplified Chinese										
		2: Traditional Chinese										
		3: Turkish										
00-05	Main Frequency Command Source Selection	0: Keypad	1	-	0	0	0	0	0	0	0	
		1: External Terminal (Analog 1)										
		2: Terminal Command UP/DOWN										
		3: Communication Control (RS-485)										
		4: Pulse Input										
		5: Reserved										
		6: RTC <small>Note8</small>										
		7: AI2 Auxiliary Frequency										
8: Manual Pulse Generator (MPG) <small>Note4</small>												
00-06	Alternative Frequency Source	0: Keypad	0 (Note4)	-	0	0	0	0	0	0	0	
		1: External Terminal (Analog 1)										

**Group 00: Basic Parameters**

Code	Parameter Name	Setting Range	Default	Unit	Control mode						Attribute	
					V/F	V/F +PG	SLV	SV	PM SV	PM SLV		SLV2
	Selection	2: Terminal Command UP/DOWN										
		3: Communication Control (RS-485)										
		4: Pulse Input										
		5: Reserved										
		6: RTC <sup>Note8</sup>										
		7: AI2 Auxiliary Frequency										
00-07	Main and Alternative Frequency Command Modes	0: Main Frequency	0	-	○	○	○	○	○	○	○	
		1: Main frequency + Alternative Frequency										
00-08	Communication Frequency Command Range	0.00~599.00	0.00	Hz	○	○	○	○	○	○	○	
00-09	Communication Frequency Command Memory Selection	0: Don't save when power supply is off. (00-08)	0	-	○	○	○	○	○	-		
		1: Save when power is off. (00-08)										
00-10	Minimum frequency detection	0: Show warning if lower than minimum frequency	0	-	○	○	○	○	○	○	○	Note1
		1: Run as minimum frequency if lower than minimum frequency										
00-11	PID Lower Limit of Frequency Selection	0: PID Sleep Limit is Lower Limit of Frequency	0	-	○	○	○	○	○	○	○	
		1: PID Sleep Limit is 0Hz										
00-12	Upper limit Frequency	0.1~109.0	100.0	%	○	○	○	○	○	○	○	
00-13	Lower limit Frequency	0.0~109.0	0.0	%	○	○	○	○	○	○	○	
00-14	Acceleration Time 1	0.1~6000.0	*	s	○	○	○	○	○	○	○	*1
00-15	Deceleration Time 1	0.1~6000.0	*	s	○	○	○	○	○	○	○	*1
00-16	Acceleration Time 2	0.1~6000.0	*	s	○	○	○	○	○	○	○	*1
00-17	Deceleration Time 2	0.1~6000.0	*	s	○	○	○	○	○	○	○	*1
00-18	Jog Frequency****	0.00~599.00	6.00	Hz	○	○	○	○	○	○	○	*1
00-19	Jog Acceleration Time	0.1~0600.0	-	s	○	○	○	○	○	○	○	*1

**Group 00: Basic Parameters**

Code	Parameter Name	Setting Range	Default	Unit	Control mode							Attribute
					V/F	V/F +PG	SLV	SV	PM SV	PM SLV	SLV2	
00-20	Jog Deceleration Time	0.1~0600.0	-	s	O	O	O	O	O	O	O	*1
00-21	Acceleration time 3	0.1~6000.0	*	s	O	O	O	O	O	O	O	*1
00-22	Deceleration time 3	0.1~6000.0	*	s	O	O	O	O	O	O	O	*1
00-23	Acceleration time 4	0.1~6000.0	*	s	O	O	O	O	O	O	O	*1
00-24	Deceleration time 4	0.1~6000.0	*	s	O	O	O	O	O	O	O	*1
00-25	Switch-Over Frequency of Acc/Dec Time 1 and Time 4	0.00~599.00	0.0	Hz	O	O	O	O	O	O	O	
00-26	Emergency Stop Time	0.1~6000.0	5.0	s	O	O	O	O	O	O	O	
00-27	HD/ND Mode Selection ***	0: HD (Heavy Duty Mode)	0	-	O	O	O	O	O	O	O	*3
		1: ND (Normal Duty Mode)					X	X	X	X	X	
00-28	Command Characteristic selection of master frequency	0: Positive Characteristic (0~10V/4~20mA is corresponding to 0~100%)	0	-	O	O	O	O	O	O	O	
		1: Negative Characteristic (0~10V/4~20mA is corresponding to 100~0%)										
00-29	Zero-Speed Operation Selection	0: Operation Based on Frequency Command	0	-	X	X	X	O	O	X	X	
		1: Stop										
		2: Operation Based on the Lowest Frequency										
		3: Zero-Speed Operation										
00-30 00-31	Reserved											
00-32	Application Selection Presets**	0: General	0	-	O	O	O	O	O	O	O	
		1: Reserved										
		2: Conveyor										
		3: Exhaust Fan										
		4: Reserved										
		5: Compressor										
		6: Hoist**										
		7: Crane**										
8: Manual Pulse Generator (MPG) <sup>Note4</sup>												

Group 00: Basic Parameters												
Code	Parameter Name	Setting Range	Default	Unit	Control mode							Attribute
					V/F	V/F +PG	SLV	SV	PM SV	PM SLV	SLV2	
00-33	Modified Parameters (only for LCD keypad)	0:Disable 1:Enable	0	-	○	○	○	○	○	○	○	*7
00-34 ~ 00-40	Reserved											
00-41	User parameter 0	Set 13-06 = 1, start user parameter. The setting range is 00-01 ~22-31, but except 00-41~00-56 and group 17 (only for LCD keypad)	00-41	-	○	○	○	○	○	○	○	*7
00-42	User parameter 1		00-42	-	○	○	○	○	○	○	○	*7
00-43	User parameter 2		00-43	-	○	○	○	○	○	○	○	*7
00-44	User parameter 3		00-44	-	○	○	○	○	○	○	○	*7
00-45	User parameter 4		00-45	-	○	○	○	○	○	○	○	*7
00-46	User parameter 5		00-46	-	○	○	○	○	○	○	○	*7
00-47	User parameter 6		00-47	-	○	○	○	○	○	○	○	*7
00-48	User parameter 7		00-48	-	○	○	○	○	○	○	○	*7
00-49	User parameter 8		00-49	-	○	○	○	○	○	○	○	*7
00-50	User parameter 9		00-50	-	○	○	○	○	○	○	○	*7
00-51	User parameter 10		00-51	-	○	○	○	○	○	○	○	*7
00-52	User parameter 11		00-52	-	○	○	○	○	○	○	○	*7
00-53	User parameter 12		00-53	-	○	○	○	○	○	○	○	*7
00-54	User parameter 13		00-54	-	○	○	○	○	○	○	○	*7
00-55	User parameter 14		00-55	-	○	○	○	○	○	○	○	*7
00-56	User parameter 15	00-56	-	○	○	○	○	○	○	○	*7	
00-57	SV High Speed Mode	0: SV High Speed Mode1 1: SV High Speed Mode2	0	-	X	X	X	○	X	X	X	

\*: Refer to the following attachment 1.

\*\* : Before to set up 00-32 Application, it should do initialized setting (parameter 13-08) first. When setting 00-32, the I/O port function changed automatically. To avoid accident, be sure to confirm the I/O port signal of inverter and external terminal control.

\*\*\* If parameter 00-27 is set to ND mode, group 02 motor 1 parameter will automatically adjust to more than 1 class of it.

If parameter 00-27 is set to HD mode, group 02 motor 1 parameter will automatically adjust to the same class of it.

It is suggested that parameter 00-27 be set first before motor performs auto-tuning because the parameter will make the motor parameter automatically be changed.

\*\*\*\*\* If the maximum output frequency of motor is over 300HZ, the frequency resolution is changed to 0.1Hz.



Group 01: V/F Control Parameters												
Code	Parameter Name	Setting Range	Default	Unit	Control mode							Attribute
					V/F	V/F+PG	SLV	SV	PM SV	PM SLV	SLV2	
01-00	V/F Curve Selection	0~FF	F	-	O	O	X	X	X	X	O	*3
01-01	Reserved											
01-02	Maximum Output Frequency of Motor 1	4.8~599.0	50.0/ 60.0	Hz	O	O	O	O	O	O	O	*8
01-03	Maximum Output Voltage of Motor 1	200V: 0.1~255.0	-	V	O	O	X	X	X	X	O	*8
		400V: 0.2~510.0	-									
		575V: 0.1~670.0	-									
		690V: 0.1~804.0	-									
01-04	Middle Output Frequency 2 of Motor 1	0.0~599.0	0.0	Hz	O	O	X	X	X	X	O	
01-05	Middle Output Voltage 2 of Motor 1	200V: 0.0~255.0	0.0	V	O	O	X	X	X	X	O	*8
		400V: 0.0~510.0										
		575V: 0.0~670.0										
		690V: 0.0~804.0										
01-06	Middle Output Frequency 1 of Motor 1	0.0~599.0	3.0	Hz	O	O	X	X	X	X	O	
01-07	Middle Output Voltage 1 of Motor 1	200V: 0.0~255.0	*	V	O	O	X	X	X	X	O	*8
		400V: 0.0~510.0										
		575V: 0.0~670.0										
		690V: 0.0~804.0										
01-08	Minimum Output Frequency of Motor 1	0.0~599.0	VF:1.5	Hz	O	O	O	O	O	O	O	
			VF+PG: 1.5									
			SLV: 0.6									
			SV:0.1									
			PMSV: 0.1									
			PMSLV :9.0									
			SLV2: 1.0									
01-09	Minimum Output Voltage of Motor 1	200V: 0.0~255.0	7.5	V	O	O	X	X	X	X	O	*8
		400V: 0.0~510.0	15.0									
		575V: 0.0~670.0										
		690V: 0.0~804.0										
01-10	Torque Compensation Gain	0.0~2.0	0.5	-	O	O	X	X	X	X	O	*1

Group 01: V/F Control Parameters												
Code	Parameter Name	Setting Range	Default	Unit	Control mode						Attribute	
					V/F	V/F +PG	SLV	SV	PM SV	PM SLV		SLV2
01-11	Selection of Torque Compensation Mode	0: Torque Compensation Mode 0	0	-	O	O	X	X	X	X	X	
		1: Torque Compensation Mode 1										
01-12	Base Frequency of Motor 1	4.8~599.0	50.0/60.0	Hz	O	O	O	O	O	O	O	*8
01-13	Base Output Voltage of Motor 1	200V: 0.0~255.0	-	V	O	O	X	X	X	X	O	*8
		400V: 0.0~510.0	-									
		575V: 0.0~670.0	-									
		690V: 0.0~804.0	-									
01-14	Input Voltage Setting	200V: 155.0~255.0	-	V	O	O	O	O	O	O	O	*8
		400V: 310.0~510.0	-									
		575V: 540.0~670.0	-									
		690V: 648.0~804.0	-									
01-15	Torque Compensation Time	0~10000	200	ms	O	O	X	X	X	X	O	
01-16	Maximum Output Frequency of Motor 2	4.8~599.0	50.0/60.0	Hz	O	X	X	X	X	X	X	*8
01-17	Maximum Output Voltage of Motor 2	200V: 0.1~255.0	-	V	O	X	X	X	X	X	X	*8
		400V: 0.2~510.0	-									
		575V: 0.1~670.0	-									
		690V: 0.1~804.0	-									
01-18	Middle Output Frequency 2 of Motor 2	0.0~599.0	0.0	Hz	O	X	X	X	X	X	X	
01-19	Middle Output Voltage 2 of Motor 2	200V: 0.0~255.0	0.0	V	O	X	X	X	X	X	X	
		400V: 0.0~510.0										
		575V: 0.0~670.0										
		690V: 0.0~804.0										
01-20	Middle Output Frequency 1 of Motor 2	0.0~599.0	3.0	Hz	O	X	X	X	X	X	X	
01-21	Middle Output Voltage 1 of Motor 2	200V: 0.0~255.0	KVA	V	O	X	X	X	X	X	X	
		400V: 0.0~510.0										
		575V: 0.0~670.0										
		690V: 0.0~804.0										
01-22	Minimum Output Frequency of Motor 2	0.0~599.0	1.5	Hz	O	X	X	X	X	X	X	
01-23	Minimum Output Voltage of Motor 2	200V: 0.0~255.0	KVA	V	O	X	X	X	X	X	X	
		400V: 0.0~510.0										
		575V: 0.0~670.0										
		690V: 0.0~804.0										

Group 01: V/F Control Parameters												
Code	Parameter Name	Setting Range	Default	Unit	Control mode						Attribute	
					V/F	V/F+PG	SLV	SV	PM SV	PM SLV		SLV2
01-24	Base Frequency of Motor 2	4.8~599.0	50.0/ 60.0	Hz	O	X	X	X	X	X	X	*8
01-25	Base Output Voltage of Motor 2	200V: 0.0~255.0	-	V	O	X	X	X	X	X	X	*8
		400V: 0.0~510.0	-									
		575V: 0.0~670.0	-									
		690V: 0.0~804.0	-									
01-26	V/F Curve Selection of Motor 2	0~FF	F	-	O	X	X	X	X	X	X	*3

**KVA:** The default value of this parameter will be changed by different capacities of inverter.

Group 02: IM Motor Parameters												
Code	Parameter Name	Setting Range	Default	Unit	Control mode						Attribute	
					V/F	V/F+PG	SLV	SV	PM SV	PM SLV		SLV2
02-00	No-Load Current of Motor1	0.01~600.00	-	A	O	X	X	X	X	X	O	
02-01	Rated Current of Motor1	Modes of V/F, V/F+PG are 10%~200% of inverter's rated current. Modes of SLV, SV are 25%~200% of inverter's rated current.	-	A	O	O	O	O	X	X	O	
02-02	Reserved											
02-03	Rated Rotation Speed of Motor1	0~60000	-	Rpm	O	O	O	O	X	X	O	
02-04	Rated Voltage of Motor1	200V: 50.0~240.0	-	V	O	O	O	O	X	X	O	*8
		400V: 100.0~480.0	-									
		575V: 150.0~670.0	-									
		690V: 200.0~804.0	-									
02-05	Rated Power of Motor1	0.01~600.00	-	kW	O	O	O	O	X	X	O	
02-06	Rated Frequency of Motor1	4.8~599.0	50.0/ 60.0	Hz	O	O	O	O	X	X	O	*8
02-07	Poles of Motor 1	2~16(Even)	4	-	O	O	O	O	X	X	O	
02-08	Reserved											
02-09	Excitation Current of Motor 1	15%~70% of Motor Rated Current	-	%	X	X	O	O	X	X	X	
02-10	Core Saturation Coefficient 1 of Motor 1	1~100	-	%	X	X	O	O	X	X	X	

Group 02: IM Motor Parameters												
Code	Parameter Name	Setting Range	Default	Unit	Control mode							Attribute
					V/F	V/F +PG	SLV	SV	PM SV	PM SLV	SLV2	
02-11	Core Saturation Coefficient 2 of Motor 1	1~100	-	%	X	X	O	O	X	X	X	
02-12	Core Saturation Coefficient 3 of Motor 1	80~300	-	%	X	X	O	O	X	X	X	
02-13	Core loss of Motor 1	0.0~15.0	-	%	O	O	X	X	X	X	O	
02-14	Reserved											
02-15	Resistance between Wires of Motor 1	0.001~60.000	-	Ω	O	O	O	O	X	X	O	
02-16	Reserved											
02-17	Reserved											
02-18	Reserved											
02-19	No-Load Voltage of Motor 1	200V: 50~240	-	V	X	X	O	O	X	X	X	
		400V: 100~480	-									
		575V: 420~600	-									
		690V: 504~720	-									
02-20	No-Load Current of Motor 2	0.01~600.00	-	A	O	X	X	X	X	X	X	
02-21	Rated Current of Motor 2	10%~200% of inverter's rated current	-	A	O	X	X	X	X	X	X	
02-22	Rated Rotation Speed of Motor 2	0~60000	-	Rpm	O	X	X	X	X	X	X	
02-23	Rated Voltage of Motor 2	200V: 50.0~240.0	-	V	O	X	X	X	X	X	X	*8
		400V: 100.0~480.0	-									
		575V: 150.0~670.0	-									
		690V: 200.0~804.0	-									
02-24	Rated Power of Motor 2	0.01~600.00	-	kW	O	X	X	X	X	X	X	
02-25	Rated Frequency of Motor 2	4.8~599.0	50.0/ 60.0	Hz	O	X	X	X	X	X	X	*8
02-26	Poles of Motor 2	2~16 (Even)	4	-	O	X	X	X	X	X	X	
02-27 ~ 02-31	Reserved											
02-32	Resistance between Wires of Motor 2	0.001~60.000	-	Ω	O	X	X	X	X	X	X	
02-33	Proportion of Motor 1 Leakage Inductance	0.1~15.0	3.4	%	X	X	O	O	X	X	X	

Group 02: IM Motor Parameters												
Code	Parameter Name	Setting Range	Default	Unit	Control mode							Attribute
					V/F	V/F +PG	SLV	SV	PM SV	PM SLV	SLV2	
02-34	Motor 1 Slip Frequency	0.10~20.00	1.00	Hz	X	X	O	O	X	X	X	
02-35 ~ 02-36	Reserved											
02-37	Motor Mechanical Loss	0.0~10.0	4.0	%	X	X	X	O	O	X	X	

Group 03: External Digital Input and Output Parameters												
Code	Parameter Name	Setting Range	Default	Unit	Control mode							Attribute
					V/F	V/F +PG	SLV	SV	PM SV	PM SLV	SLV2	
03-00	Multi-Function Terminal Function Setting-S1	0: 2-Wire Sequence (ON: Forward Run Command)	0	-	O	O	O	O	O	O	O	
		1: 2-Wire Sequence (ON: Reverse Run Command)			O	O	O	O	O	O		
		2: Multi-Speed/Position Setting Command 1			O	O	O	O	O	O		
		3: Multi-Speed/Position Setting Command 2			O	O	O	O	O	O		
		4: Multi-Speed/Position Setting Command 3			O	O	O	O	O	O		
		5: Multi-Speed/Position Setting Command 4			O	O	O	O	O	O		
		6: Forward Jog Run Command			O	O	O	O	O	O		
03-01	Multi-Function Terminal Function Setting-S2	7: Reverse Jog Run Command	1	-	O	O	O	O	O	O	O	
		8: UP Frequency Increasing Command			O	O	O	O	O	O		
		9: DOWN Frequency Decreasing Command			O	O	O	O	O	O		
		10: Acceleration/Deceleration Time Selection 1			O	O	O	O	O	O		
		11: Inhibit Acceleration/Deceleration Command			O	O	O	O	O	O		
		12: Main/ Alternative Run Switch Function			O	O	O	O	O	O		
		13: Main/ Alternative Frequency Switch Function			O	O	O	O	O	O		

**Group 03: External Digital Input and Output Parameters**

Code	Parameter Name	Setting Range	Default	Unit	Control mode							Attribute
					V/F	V/F +PG	SLV	SV	PM SV	PM SLV	SLV2	
03-02	Multi-Function Terminal Function Setting-S3	14: Emergency Stop (decelerate to zero and stop)	2	-	O	O	O	O	O	O	O	
		15: External Baseblock Command (rotation freely to stop)			O	O	O	O	O	O		
		16: PID Control Disable			O	O	O	O	O	O		
		17: Fault Reset (RESET)			O	O	O	O	O	O		
		18: Reserved			-	-	-	-	-	-		
		19: Speed Search 1 (from the maximum frequency)			O	O	O	O	O	X	O	
		20: Manual Energy Saving Function			O	O	X	X	X	X	X	
03-03	Multi-Function Terminal Function Setting-S4	21: PID Integral Reset	3	-	O	O	O	O	O	O	O	
		22~23 : Reserved			-	-	-	-	-	-		
		24: PLC Input			O	O	O	O	O	O		
		25: External Fault			O	O	O	O	O	O		
		26: 3-Wire Sequence (Forward/Reverse command)			O	O	O	O	O	O		
		27: Local/ Remote Selection			O	O	O	O	O	O		
03-04	Multi-Function Terminal Function Setting-S5	28: Remote Mode Selection	4	-	O	O	O	O	O	O	O	
		29: Jog Frequency Selection			O	O	O	O	O	O		
		30: Acceleration/ Deceleration Time Selection 2			O	O	O	O	O	O		
		31: Inverter Overheating Warning			O	O	O	O	O	O		
		32: Sync Command			O	O	O	O	O	O		
		33: DC Braking			O	O	O	O	X	X	O	
		34: Speed Search 2 (from the frequency command)			O	O	O	O	O	X	O	
		35: Timing Function Input			O	O	O	O	O	O		
36: PID Soft Start Disable	O	O	O	O	O	O						
03-05	Multi-Function Terminal Function Setting-S6	37: Traversing Operation	17	-	O	O	X	X	X	X	O	
		38: Upper Deviation of Traverse Operation			O	O	X	X	X	X	O	
		39: Lower Deviation of Traverse Operation			O	O	X	X	X	X	O	
		40: Switching between Motor 1/Motor 2			O	O	X	X	X	X	X	
		41: PID Sleep			O	O	O	O	O	O	O	

**Group 03: External Digital Input and Output Parameters**

Code	Parameter Name	Setting Range	Default	Unit	Control mode							Attribute
					V/F	V/F +PG	SLV	SV	PM SV	PM SLV	SLV2	
		42: PG Disable			X	O	X	X	X	X	X	
		43: PG Integral Reset			X	O	X	O	O	X	X	
03-06	Multi-Function Terminal Function Setting-S7	44: Mode Switching between Speed and Torque	29*	-	X	X	X	O	O	X	X	
		45: Negative Torque Command			X	X	X	O	O	X	X	
		46: Zero-Servo Command			X	X	X	O	O	X	X	
		47: Fire mode(Forced Operation mode)			O	O	O	O	O	O	O	
		48: KEB Acceleration			O	O	X	X	X	X	O	
		49: Parameters Writing Allowable			O	O	O	O	O	O	O	
		50: Unattended Start Protection (USP)			O	O	O	O	O	O	O	
03-07	Multi-Function Terminal Function Setting-S8	51: Mode Switching between Speed and Position	15	-	X	X	X	O	O	X	X	
		52: Multi Position Reference Enable			X	X	X	O	O	X	X	
		53: 2-Wire Self Holding Mode (Stop Command)			O	O	O	O	O	O	O	
		54: Reserved			-	-	-	-	-	-	-	
		55: RTC Time Enable			O	O	O	O	O	O	O	Note8
		56: RTC Offset Enable			O	O	O	O	O	O	O	Note8
		57: Reserved			-	-	-	-	-	-	-	
		58: Safety Function			O	O	O	O	O	O	O	
		59~61: Reserved			-	-	-	-	-	-	-	
		62: EPS Function			O	O	O	O	O	O	O	
		63~64: Reserved			-	-	-	-	-	-	-	
		65: Short-circuit braking			X	X	X	X	X	O	X	Note1
		66: PID Disabled 2			O	O	O	O	O	O	O	Note4
		67: Manual Pulse Generator Mode Switch			O	X	X	X	X	X	X	Note4
		68: External Fault 2			O	O	O	O	O	O	O	Note4
69: External Overload	O	O	O	O	O	O	O	Note4				
03-08	(S1~S8) DI Scan Time	0: Scan Time 4ms 1: Scan Time 8ms	1	-	O	O	O	O	O	O	O	
03-09	Multi-Function Terminal S1-S4 Type Selection	xxx0b: S1 A Contact xxx1b: S1 B Contact	0000b	-	O	O	O	O	O	O	O	O
		xx0xb: S2 A Contact xx1xb: S2 B Contact										
		x0xxb: S3 A Contact x1xxb: S3 B Contact										
		0xxxb: S4 A Contact 1xxxb: S4 B Contact										

**Group 03: External Digital Input and Output Parameters**

Code	Parameter Name	Setting Range	Default	Unit	Control mode							Attribute
					V/F	V/F +PG	SLV	SV	PM SV	PM SLV	SLV2	
03-10	Multi-Function Terminal S5-S8 Type Selection	xxx0b: S5 A Contact	0000b	-	0	0	0	0	0	0	0	
		xxx1b: S5 B Contact										
		xx0xb: S6 A Contact										
		xx1xb: S6 B Contact										
		x0xxb: S7 A Contact										
x1xxb: S7 B Contact												
		0xxb: S8 A Contact										
		1xxb: S8 B Contact										
03-11	Relay (R1A-R1C) Output	0: During Running	1 (Note4)	-	0	0	0	0	0	0	0	
		1: Fault Contact Output			0	0	0	0	0	0	0	
		2: Frequency Agree			0	0	0	0	0	0	0	
		3: Setting Frequency Agree			0	0	0	0	0	0	0	
		4: Frequency Detection 1 (≧03-13+03-14)			0	0	0	0	0	0	0	
		5: Frequency Detection 2 (≦ 03-13+03-14)			0	0	0	0	0	0	0	
		6: Automatic Restart			0	0	0	0	0	0	0	
		7~8: Reserved			-	-	-	-	-	-	-	
		9: Baseblock			0	0	0	0	0	0	0	
		10~11: Reserved			-	-	-	-	-	-	-	
		12: Over-Torque Detection			0	0	0	0	0	0	0	
		13: Current Agree			0	0	0	0	0	0	0	
		14: Mechanical Braking Control (03-17~18)			0	0	0	0	0	0	0	
		15~17: Reserved			-	-	-	-	-	-	-	
		18: PLC status			0	0	0	0	0	0	0	
19: PLC Control Contact	0	0	0	0	0	0	0					
03-12 (Note)	Relay (R2A-R2C) Output	20: Zero Speed	0 (Note4)	-	0	0	0	0	0	0	0	
		21: Inverter Ready			0	0	0	0	0	0	0	
		22: Under Voltage Detection			0	0	0	0	0	0	0	
		23: Source of Operation Command			0	0	0	0	0	0	0	
		24: Source of Frequency Command			0	0	0	0	0	0	0	
		25: Low Torque Detection			0	0	0	0	0	0	0	
		26: Frequency Reference Missing			0	0	0	0	0	0	0	
		27: Timing Function Output			0	0	0	0	0	0	0	
		28: Traverse Operation UP Status			0	0	X	X	X	X	0	
		29 : During Traverse Operation Status			0	0	X	X	X	X	0	
		30 : Motor 2 Selection			0	0	0	0	0	0	0	



**Group 03: External Digital Input and Output Parameters**

Code	Parameter Name	Setting Range	Default	Unit	Control mode							Attribute
					V/F	V/F +PG	SLV	SV	PM SV	PM SLV	SLV2	
		31: Zero Speed Servo Status (Position Mode)			X	X	X	O	O	X	X	
		32: Communication Control Contacts			O	O	O	O	O	O	O	
		33: RTC Timer 1			O	O	O	O	O	O	O	Note8
		34: RTC Timer 2			O	O	O	O	O	O	O	Note8
		35: RTC Timer 3			O	O	O	O	O	O	O	Note8
		36: RTC Timer 4			O	O	O	O	O	O	O	Note8
		37: PID Feedback Loss Detection Output			O	O	O	O	O	O	O	
		38: Brake Release			X	X	O	O	O	X	X	
		39: Frequency Detection 1 (dedicated for Crane)			X	X	O	X	X	X	X	
		40: Frequency Output			X	X	X	O	O	X	X	
		41: Position Agree (Position Mode)			X	X	X	O	O	X	X	
		42~44: Reserved			-	-	-	-	-	-	-	
		45: PID sleep			O	O	O	O	O	O	O	
		46~49: Reserved			-	-	-	-	-	-	-	
		50: Frequency Detection 3 ( $\cong$ 03-44+03-45)			O	O	O	O	O	O	O	
		51: Frequency Detection 4 ( $\cong$ 03-44+03-45)			O	O	O	O	O	O	O	
		52: Frequency Detection 5 ( $\cong$ 03-46+03-47)			O	O	O	O	O	O	O	
		53: Frequency Detection 6 ( $\cong$ 03-46+03-47)			O	O	O	O	O	O	O	
		54: Turn on short-circuit braking			X	X	X	X	X	O	X	Note1
		57: Low Current Detection			O	O	O	O	O	O	O	Note2
		58: Frequency Deceleration Detection			O	O	O	O	O	O	O	Note4
		59: Over-Temperature Detection			O	O	O	O	O	O	O	Note4
03-13	Frequency Detection Level	0.0~599.0	0.0	Hz	O	O	O	O	O	O	O	
03-14	Frequency Detection Width	0.1~25.5	2.0	Hz	O	O	O	O	O	O	O	
03-15	Current Agree Level	0.1~999.9	0.1	A	O	O	O	O	O	O	O	
03-16	Delay Time of Current Agree Detection	0.1~10.0	0.1	s	O	O	O	O	O	O	O	

**Group 03: External Digital Input and Output Parameters**

Code	Parameter Name	Setting Range	Default	Unit	Control mode							Attribute
					V/F	V/F +PG	SLV	SV	PM SV	PM SLV	SLV2	
03-17	**Mechanical Braking Release Level	0.00~599.00	0.00	Hz	○	○	○	○	○	○	○	
03-18	**Mechanical Braking Level Set	0.00~599.00	0.00	Hz	○	○	○	○	○	○	○	
03-19	Relay (R1A-R2A) Type	xxx0b: R1 A Contact xxx1b: R1 B Contact	0000b	-	○	○	○	○	○	○	○	
		xx0xb: R2 A Contact xx1xb: R2 C Contact										
		0xxxb: R4 A Contact 1xxxb: R4 B Contact										*10
03-20	Relay (R4A-R4C) Output	Range and definition are the same as those of 03-11, 03-12	2	-	○	○	○	○	○	○	○	*10
03-21	Photo-coupler Output Selection (DO2-DOG)	Range and definition are the same as those of 03-11, 03-12	3	-	○	○	○	○	○	○	○	*10
03-22	Reserved											
03-23	Reserved											
03-24	Reserved											
03-25	Reserved											
03-26	Reserved											
03-27	UP/DOWN Frequency Hold/Adjust Selection	0: Hold last set frequency when stopped	0	-	○	○	○	○	○	○	○	
		1: Set frequency to 0 when stopped										
		2: Allow speed changes from last set frequency when stopped										
		3: Refresh frequency at acceleration.										
03-28	Photo-coupler Output (DO1-DOG)	Range and definition are the same as those of 03-11, 03-12	0	-	○	○	○	○	○	○	○	
03-29	Photo-coupler Output Selection (DO1-DOG) (DO2-DOG)	xxx0b: Photo-coupler 1 A Contact xxx1b: Photo-coupler 1 B Contact	0000b	-	○	○	○	○	○	○	○	
		xx0xb: Photo-coupler 2 A Contact xx1xb: Photo-coupler 2 B Contact										
03-30	Selection of Pulse Input	0: General Pulse Input	0	-	○	○	○	○	○	○	○	
		1: PWM										
03-31	Scale of Pulse Input	Depending on the setting of 03-30	1000	Hz	○	○	○	○	○	○	○	*1

**Group 03: External Digital Input and Output Parameters**

Code	Parameter Name	Setting Range	Default	Unit	Control mode							Attribute	
					V/F	V/F +PG	SLV	SV	PM SV	PM SLV	SLV2		
		03-30 = 0: 50~32000Hz 03-30 = 1:10~1000Hz											
03-32	Pulse Input Gain	0.0~1000.0	100	%	O	O	O	O	O	O	O	O	*1
03-33	Pulse Input Bias	-100.0~100.0	0.0	%	O	O	O	O	O	O	O	O	*1
03-34	Filter Time of Pulse Input	0.00~2.00	0.1	Sec	O	O	O	O	O	O	O	O	*1
03-35	Function Setting of Pulse Output	1: Frequency Command	2	-	O	O	O	O	O	O	O	O	*1
		2: Output Frequency											
		3: Output Frequency after Soft-Start											
		4: Motor Speed											
		5: PID Feedback											
		6: PID Input											
		7: PG Output (with PG card)											
03-36	Scale of Pulse Output	1~32000	1000	Hz	O	O	O	O	O	O	O	O	*1
03-37	Timer ON Delay (DIO)	0.0~6000.0	0.0	s	O	O	O	O	O	O	O	O	
03-38	Timer OFF Delay (DIO)	0.0~6000.0	0.0	s	O	O	O	O	O	O	O	O	
03-39	Reserved												
03-40	Up/Down Frequency Width Setting	0.00~5.00	0.00	Hz	O	O	O	O	O	O	O	O	
03-41	Torque Detection Level	0~150	10	%	X	X	O	O	O	X	X		
03-42	Brake Release Delay Time	0.00~65.00	0.00	s	X	X	O	O	O	X	X		
03-43	UP/DOWN Acceleration/Deceleration Selection	0: Acceleration/Deceleration Time 1	0	-	O	O	O	O	O	O	O	O	
		1: Acceleration/Deceleration Time 2											
03-44	Frequency Detection Level 2	0.0~599.0	0.0	Hz	O	O	O	O	O	O	O	O	
03-45	Frequency Detection Width 2	0.1~25.5	2.0	Hz	O	O	O	O	O	O	O	O	
03-46	Frequency Detection Level 3	0.0~599.0	0.0	Hz	O	O	O	O	O	O	O	O	
03-47	Frequency Detection Width 3	0.1~25.5	2.0	Hz	O	O	O	O	O	O	O	O	
03-48	Low Current Detection Level	0.0~999.9	0.1	A	O	O	O	O	O	O	O	O	Note2

Group 03: External Digital Input and Output Parameters												
Code	Parameter Name	Setting Range	Default	Unit	Control mode							Attribute
					V/F	V/F +PG	SLV	SV	PM SV	PM SLV	SLV2	
03-49	Low Current Detection Delay Time	0.00~655.34 (Note4)	0.01	Sec	○	○	○	○	○	○	○	Note2
03-50	Frequency Detection Level 4	0.0~599.0	0.0	Hz	○	○	○	○	○	○	○	Note3
03-51	Frequency Detection Level 5	0.0~599.0	0.0	Hz	○	○	○	○	○	○	○	Note3
03-52	Frequency Detection Level 6	0.0~599.0	0.0	Hz	○	○	○	○	○	○	○	Note3
03-53	Current Agree Level 2	0.0~999.9	0.1	A	○	○	○	○	○	○	○	Note4

\* 2-wire operation mode: 29; 3-wire operation mode: 26.

\* \*If the maximum output frequency of motor is over 300HZ, the frequency resolution is changed to 0.1Hz

Note: For frame 1, the DO2 function is setting by 03-12.

Note: For standard H & C type frame 1, the DO2 function is setting by 03-12.

Group 04: External Analog Input and Output Parameters													
Code	Parameter Name	Setting Range	Default	Unit	Control mode							Attribute	
					V/F	V/F +PG	SLV	SV	PM SV	PM SLV	SLV2		
04-00	AI Input Signal Type	0: AI1:0~10V AI2:0~10V	1	-	○	○	○	○	○	○	○	○	
		1: AI1:0~10V AI2:4~20mA											
		2: AI1: -10~10V AI2: 0~10V											
		3: AI1: -10~10V AI2: 4~20mA											
		4: AI1: 4~20mA AI2: 0~10V											*9
		5: AI1: 4~20mA AI2: 4~20mA											*9
04-01	AI1 Signal Scanning and Filtering Time	0.00~2.00	0.03	s	○	○	○	○	○	○	○		
04-02	AI1 Gain	0.0~1000.0	100.0	%	○	○	○	○	○	○	○	*1	
04-03	AI1 Bias	-100.0~100.0	0	%	○	○	○	○	○	○	○	*1	
04-04	Negative AI	0: Disable	0	-	○	○	○	○	○	○	○	○	
		1: Enable											Note4
04-05	AI2 Function Setting	0: Auxiliary Frequency	0	-	○	○	○	○	○	○	○	○	
		1: Frequency Reference Gain											

**Group 04: External Analog Input and Output Parameters**

Code	Parameter Name	Setting Range	Default	Unit	Control mode							Attribute
					V/F	V/F +PG	SLV	SV	PM SV	PM SLV	SLV2	
		2: Frequency Reference Bias			○	○	○	○	○	○	○	
		3: Output Voltage Bias			○	○	X	X	○	○	○	
		4: Coefficient of Acceleration and Deceleration Reduction			○	○	○	○	○	○	○	
		5: DC Braking Current			○	○	○	○	X	X	○	
		6: Over-Torque Detection Level			○	○	○	○	○	○	○	
		7: Stall Prevention Level During Running			○	○	X	X	X	X	○	
		8: Frequency Lower Limit			○	○	○	○	○	○	○	
		9: Jump Frequency 4			○	○	○	○	○	○	○	
		10: Added to AI1			○	○	○	○	○	○	○	
		11: Positive torque limit			X	X	○	○	○	○	X	
		12: Negative torque limit			X	X	○	○	○	○	X	
		13: Regenerative Torque Limit			X	X	○	○	○	○	X	
		14: Positive / Negative Torque Limit			X	X	○	○	○	○	X	
		15: Torque Reference/ Torque Limit (in Speed Control)			X	X	X	○	○	X	X	
		16: Torque Compensation			X	X	○	○	○	X	X	
		17: PTC Overheat Protection			○	○	○	○	○	○	○	
04-06	AI2 Signal Scanning and Filtering Time	0.00~2.00	0.03	s	○	○	○	○	○	○	○	
04-07	AI2 Gain	0.0~1000.0	100.0	%	○	○	○	○	○	○	○	*1
04-08	AI2 Bias	-100.0~100.0	0	%	○	○	○	○	○	○	○	*1
04-09	AI Input Signal Type of I/O card	0: AI3:0~10V 1: AI3:-10~10V 2: AI3:4~20mA	0	-	○	○	○	○	○	○	○	*10
04-10	AI3 Function Setting	Range and definition are the same as those of 04-05	10	-	○	○	○	○	○	○	○	*10

**Group 04: External Analog Input and Output Parameters**

Code	Parameter Name	Setting Range	Default	Unit	Control mode							Attribute
					V/F	V/F +PG	SL V	SV	PM SV	PM SLV	SLV2	
04-11	AO1 Function Setting	0: Output Frequency	0	-	0	0	0	0	0	0	0	
		1: Frequency Command			0	0	0	0	0	0	0	
		2: Output Voltage			0	0	0	0	0	0	0	
		3: DC Voltage			0	0	0	0	0	0	0	
		4: Output Current			0	0	0	0	0	0	0	
		5: Output Power			0	0	0	0	0	0	0	
		6: Motor Speed			0	0	0	0	0	0	0	
		7: Output Power Factor			0	0	0	0	0	0	0	
		8: AI1 Input			0	0	0	0	0	0	0	
		9: AI2 Input			0	0	0	0	0	0	0	
		10: Torque Command			X	X	0	0	0	0	X	
		11: q-axis Current			X	X	0	0	0	0	X	
		12: d-axis Current			X	X	0	0	0	0	X	
		13: Speed Deviation			X	X	X	0	0	X	X	
		14: Reserved			-	-	-	-	-	-	-	
		15: ASR Output			X	0	X	0	0	X	X	
		16: Reserved			-	-	-	-	-	-	-	
		17: q-axis Voltage			X	X	0	0	0	0	X	
		18: d-axis Voltage			X	X	0	0	0	0	X	
		19~20: Reserved			-	-	-	-	-	-	-	
		21: PID Input			0	0	0	0	0	0	0	
		22: PID Output			0	0	0	0	0	0	0	
		23: PID Target Value			0	0	0	0	0	0	0	
		24: PID Feedback Value			0	0	0	0	0	0	0	
		25: Output Frequency of the Soft Starter			0	0	0	0	0	0	0	
		26: PG Feedback			X	0	X	0	0	X	X	
		27: Reserved			-	-	-	-	-	-	-	
		28: Communication control			0	0	0	0	0	0	0	
04-12	AO1 Gain	0.0~1000.0	100.0	%	0	0	0	0	0	0	0	*1
04-13	AO1 Bias	-100.0~100.0	0	%	0	0	0	0	0	0	0	*1
04-14	Reserved											
04-15	Reserved											
04-16	AO2 Function Setting	Range and definition are the same as those of 04-11.	3	-	0	0	0	0	0	0	0	
04-17	AO2 Gain	0.0~1000.0	100.0	%	0	0	0	0	0	0	0	*1
04-18	AO2 Bias	-100.0~100.0	0	%	0	0	0	0	0	-		*1
04-19	AO Output Signal Type	0: AO1 0~10V AO2 0~10V	0	-	0	0	0	0	0	0	0	
		1: AO1 0~10V AO2 4~20mA										

**Group 04: External Analog Input and Output Parameters**

Code	Parameter Name	Setting Range	Default	Unit	Control mode							Attribute	
					V/F	V/F +PG	SL V	SV	PM SV	PM SLV	SLV2		
		2: AO1 4~20mA AO2 0~10V											*9
		3: AO1 4~20mA AO2 4~20mA											*9
04-20	Filter Time of AO Signal Scan	0.00~0.50	0.00	s	0	0	0	0	0	0	0	0	*1
04-21	AI3 Signal Scanning and Filtering Time	0.00~2.00	0.03	s	0	0	0	0	0	0	0	0	*10
04-22	AI3 Gain	0.0~1000.0	100.0	%	0	0	0	0	0	0	0	0	*10
04-23	AI3 Bias	-100.0~100.0	0	%	0	0	0	0	0	0	0	0	*10

**Group 05: Multi-Speed Parameters**

Code	Parameter Name	Setting Range	Default	Unit	Control mode							Attribute	
					V/F	V/F +PG	SLV	SV	PM SV	PM SLV	SLV2		
05-00	Acceleration and Deceleration Selection of Multi-Speed	0: Acceleration and deceleration time are set by 00-14 ~ 00-24	0	-	0	0	0	0	0	0	0	0	
		1: Acceleration and Deceleration Time are set by 05-17 ~ 05-48											
05-01	*Frequency Setting of Speed-Stage 0	0.00~599.00	5.00	Hz	0	0	0	0	0	0	0	0	*1
05-02	*Frequency Setting of Speed-Stage 1	0.00~599.00	5.00	Hz	0	0	0	0	0	0	0	0	*1
05-03	*Frequency Setting of Speed-Stage 2	0.00~599.00	10.00	Hz	0	0	0	0	0	0	0	0	*1
05-04	*Frequency Setting of Speed-Stage 3	0.00~599.00	20.00	Hz	0	0	0	0	0	0	0	0	*1
05-05	*Frequency Setting of Speed-Stage 4	0.00~599.00	30.00	Hz	0	0	0	0	0	0	0	0	*1
05-06	*Frequency Setting of Speed-Stage 5	0.00~599.00	40.00	Hz	0	0	0	0	0	0	0	0	*1
05-07	*Frequency Setting of Speed-Stage 6	0.00~599.00	50.00	Hz	0	0	0	0	0	0	0	0	*1
05-08	*Frequency Setting of Speed-Stage 7	0.00~599.00	50.00	Hz	0	0	0	0	0	0	0	0	*1
05-09	*Frequency Setting of Speed-Stage 8	0.00~599.00	5.00	Hz	0	0	0	0	0	0	0	0	*1
05-10	*Frequency Setting of Speed-Stage 9	0.00~599.00	5.00	Hz	0	0	0	0	0	0	0	0	*1
05-11	*Frequency Setting of Speed-Stage 10	0.00~599.00	5.00	Hz	0	0	0	0	0	0	0	0	*1

**Group 05: Multi-Speed Parameters**

Code	Parameter Name	Setting Range	Default	Unit	Control mode							Attribute
					V/F	V/F+PG	SLV	SV	PM SV	PM SLV	SLV2	
05-12	*Frequency Setting of Speed-Stage 11	0.00~599.00	5.00	Hz	O	O	O	O	O	O	O	*1
05-13	*Frequency Setting of Speed-Stage 12	0.00~599.00	5.00	Hz	O	O	O	O	O	O	O	*1
05-14	*Frequency Setting of Speed-Stage 13	0.00~599.00	5.00	Hz	O	O	O	O	O	O	O	*1
05-15	*Frequency Setting of Speed-Stage 14	0.00~599.00	5.00	Hz	O	O	O	O	O	O	O	*1
05-16	*Frequency Setting of Speed-Stage 15	0.00~599.00	5.00	Hz	O	O	O	O	O	O	O	*1
05-17	Acceleration Time Setting of Multi Speed 0	0.1~6000.0	10.0	s	O	O	O	O	O	O	O	
05-18	Deceleration Time Setting of Multi Speed 0	0.1~6000.0	10.0	s	O	O	O	O	O	O	O	
05-19	Acceleration Time Setting of Multi Speed 1	0.1~6000.0	10.0	s	O	O	O	O	O	O	O	
05-20	Deceleration Time Setting of Multi Speed 1	0.1~6000.0	10.0	s	O	O	O	O	O	O	O	
05-21	Acceleration Time Setting of Multi Speed 2	0.1~6000.0	10.0	s	O	O	O	O	O	O	O	
05-22	Deceleration Time Setting of Multi Speed 2	0.1~6000.0	10.0	s	O	O	O	O	O	O	O	
05-23	Acceleration Time Setting of Multi Speed 3	0.1~6000.0	10.0	s	O	O	O	O	O	O	O	
05-24	Deceleration Time Setting of Multi Speed 3	0.1~6000.0	10.0	s	O	O	O	O	O	O	O	
05-25	Acceleration Time Setting of Multi Speed 4	0.1~6000.0	10.0	s	O	O	O	O	O	O	O	
05-26	Deceleration Time Setting of Multi Speed 4	0.1~6000.0	10.0	s	O	O	O	O	O	O	O	
05-27	Acceleration Time Setting of Multi Speed 5	0.1~6000.0	10.0	s	O	O	O	O	O	O	O	
05-28	Deceleration Time Setting of Multi Speed 5	0.1~6000.0	10.0	s	O	O	O	O	O	O	O	
05-29	Acceleration Time Setting of Multi Speed 6	0.1~6000.0	10.0	s	O	O	O	O	O	O	O	
05-30	Deceleration Time Setting of Multi	0.1~6000.0	10.0	s	O	O	O	O	O	O	O	



**Group 05: Multi-Speed Parameters**

Code	Parameter Name	Setting Range	Default	Unit	Control mode							Attribute	
					V/F	V/F +PG	SLV	SV	PM SV	PM SLV	SLV2		
	Speed 6												
05-31	Acceleration Time Setting of Multi Speed 7	0.1~6000.0	10.0	s	O	O	O	O	O	O	O		
05-32	Deceleration Time Setting of Multi Speed 7	0.1~6000.0	10.0	s	O	O	O	O	O	O	O		
05-33	Acceleration Time Setting of Multi Speed 8	0.1~6000.0	10.0	s	O	O	O	O	O	O	O		
05-34	Deceleration Time Setting of Multi Speed 8	0.1~6000.0	10.0	s	O	O	O	O	O	O	O		
05-35	Acceleration Time Setting of Multi Speed 9	0.1~6000.0	10.0	s	O	O	O	O	O	O	O		
05-36	Deceleration Time Setting of Multi Speed 9	0.1~6000.0	10.0	s	O	O	O	O	O	O	O		
05-37	Acceleration Time Setting of Multi Speed 10	0.1~6000.0	10.0	s	O	O	O	O	O	O	O		
05-38	Deceleration Time Setting of Multi Speed 10	0.1~6000.0	10.0	s	O	O	O	O	O	O	O		
05-39	Acceleration Time Setting of Multi Speed 11	0.1~6000.0	10.0	s	O	O	O	O	O	O	O		
05-40	Deceleration Time Setting of Multi Speed 11	0.1~6000.0	10.0	s	O	O	O	O	O	O	O		
05-41	Acceleration Time Setting of Multi Speed 12	0.1~6000.0	10.0	s	O	O	O	O	O	O	O		
05-42	Deceleration Time Setting of Multi Speed 12	0.1~6000.0	10.0	s	O	O	O	O	O	O	O		
05-43	Acceleration Time Setting of Multi Speed 13	0.1~6000.0	10.0	s	O	O	O	O	O	O	O		
05-44	Deceleration Time Setting of Multi Speed 13	0.1~6000.0	10.0	s	O	O	O	O	O	O	O		
05-45	Acceleration Time Setting of Multi Speed 14	0.1~6000.0	10.0	s	O	O	O	O	O	O	O		
05-46	Deceleration Time Setting of Multi Speed 14	0.1~6000.0	10.0	s	O	O	O	O	O	O	O		
05-47	Acceleration Time Setting of Multi Speed 15	0.1~6000.0	10.0	s	O	O	O	O	O	O	O		

Group 05: Multi-Speed Parameters												
Code	Parameter Name	Setting Range	Default	Unit	Control mode							Attribute
					V/F	V/F +PG	SLV	SV	PM SV	PM SLV	SLV2	
05-48	Deceleration Time Setting of Multi Speed 15	0.1~6000.0	10.0	s	○	○	○	○	○	○	○	

\* If the maximum output frequency of motor is over 300HZ, the frequency resolution is changed to 0.1Hz

Group 06: Automatic Program Operation Parameters												
Code	Parameter Name	Setting Range	Default	Unit	Control mode							Attribute
					V/F	V/F +PG	SLV	SV	PM SV	PM SLV	SLV 2	
06-00	Automatic Operation Mode Selection	0: Disable	0	-	○	○	○	○	X	X	X	○
		1: Execute a single cycle operation mode. Restart speed is based on the previous stopped speed.										
		2: Execute continuous cycle operation mode. Restart speed is based on the previous stopped speed.										
		3: After the completion of a single cycle, the on-going operation speed is based on the speed of the last stage. Restart speed is based on the previous stopped speed.										
		4: Execute a single cycle operation mode. Restart speed will be based on the speed of stage 0.										
		5: Execute continuous cycle operation mode. Restart speed will be based on the speed of stage 0.										
		6: After the completion of a single cycle, the on-going operation speed is based on the speed of the last stage. Restart speed is based on the speed of stage 0.										

**Group 06: Automatic Program Operation Parameters**

Code	Parameter Name	Setting Range	Default	Unit	Control mode							Attribute
					V/F	V/F +PG	SLV	SV	PM SV	PM SLV	SLV 2	
06-01	*Frequency Setting of Operation-Stage 1	0.00~599.00	5.00	Hz	O	O	O	X	X	X	O	*1
06-02	*Frequency Setting of Operation-Stage 2	0.00~599.00	10.00	Hz	O	O	O	X	X	X	O	*1
06-03	*Frequency Setting of Operation-Stage 3	0.00~599.00	20.00	Hz	O	O	O	X	X	X	O	*1
06-04	*Frequency Setting of Operation-Stage 4	0.00~599.00	30.00	Hz	O	O	O	X	X	X	O	*1
06-05	*Frequency Setting of Operation-Stage 5	0.00~599.00	40.00	Hz	O	O	O	X	X	X	O	*1
06-06	*Frequency Setting of Operation-Stage 6	0.00~599.00	50.00	Hz	O	O	O	X	X	X	O	*1
06-07	*Frequency Setting of Operation-Stage 7	0.00~599.00	50.00	Hz	O	O	O	X	X	X	O	*1
06-08	*Frequency Setting of Operation-Stage 8	0.00~599.00	5.00	Hz	O	O	O	X	X	X	O	*1
06-09	*Frequency Setting of Operation-Stage 9	0.00~599.00	5.00	Hz	O	O	O	X	X	X	O	*1
06-10	*Frequency Setting of Operation-Stage 10	0.00~599.00	5.00	Hz	O	O	O	X	X	X	O	*1
06-11	*Frequency Setting of Operation-Stage 11	0.00~599.00	5.00	Hz	O	O	O	X	X	X	O	*1
06-12	*Frequency Setting of Operation-Stage 12	0.00~599.00	5.00	Hz	O	O	O	X	X	X	O	*1
06-13	*Frequency Setting of Operation-Stage 13	0.00~599.00	5.00	Hz	O	O	O	X	X	X	O	*1
06-14	*Frequency Setting of Operation-Stage 14	0.00~599.00	5.00	Hz	O	O	O	X	X	X	O	*1
06-15	*Frequency Setting of Operation-Stage 15	0.00~599.00	5.00	Hz	O	O	O	X	X	X	O	*1

**Group 06: Automatic Program Operation Parameters**

Code	Parameter Name	Setting Range	Default	Unit	Control mode							Attribute
					V/F	V/F +PG	SLV	SV	PM SV	PM SLV	SLV 2	
06-16	Operation Time Setting of Speed-Stage 0	0.0~6000.0	0.0	s	O	O	O	X	X	X	O	*1
06-17	Operation Time Setting of Speed-Stage 1	0.0~6000.0	0.0	s	O	O	O	X	X	X	O	*1
06-18	Operation Time Setting of Speed-Stage 2	0.0~6000.0	0.0	s	O	O	O	X	X	X	O	*1
06-19	Operation Time Setting of Speed-Stage 3	0.0~6000.0	0.0	s	O	O	O	X	X	X	O	*1
06-20	Operation Time Setting of Speed-Stage 4	0.0~6000.0	0.0	s	O	O	O	X	X	X	O	*1
06-21	Operation Time Setting of Speed-Stage 5	0.0~6000.0	0.0	s	O	O	O	X	X	X	O	*1
06-22	Operation Time Setting of Speed-Stage 6	0.0~6000.0	0.0	s	O	O	O	X	X	X	O	*1
06-23	Operation Time Setting of Speed-Stage 7	0.0~6000.0	0.0	s	O	O	O	X	X	X	O	*1
06-24	Operation Time Setting of Speed-Stage 8	0.0~6000.0	0.0	s	O	O	O	X	X	X	O	*1
06-25	Operation Time Setting of Speed-Stage 9	0.0~6000.0	0.0	s	O	O	O	X	X	X	O	*1
06-26	Operation Time Setting of Speed-Stage 10	0.0~6000.0	0.0	s	O	O	O	X	X	X	O	*1
06-27	Operation Time Setting of Speed-Stage 11	0.0~6000.0	0.0	s	O	O	O	X	X	X	O	*1
06-28	Operation Time Setting of Speed-Stage 12	0.0~6000.0	0.0	s	O	O	O	X	X	X	O	*1
06-29	Operation Time Setting of Speed-Stage 13	0.0~6000.0	0.0	s	O	O	O	X	X	X	O	*1
06-30	Operation Time Setting of Speed-Stage 14	0.0~6000.0	0.0	s	O	O	O	X	X	X	O	*1
06-31	Operation Time Setting of Speed-Stage 15	0.0~6000.0	0.0	s	O	O	O	X	X	X	O	*1
06-32	Operation Direction Selection of Speed-Stage 0	0: Stop 1: Forward 2: Reverse	0	-	O	O	O	X	X	X	O	

**Group 06: Automatic Program Operation Parameters**

Code	Parameter Name	Setting Range	Default	Unit	Control mode							Attribute
					V/F	V/F +PG	SLV	SV	PM SV	PM SLV	SLV 2	
06-33	Operation Direction Selection of Speed-Stage 1	0: Stop 1: Forward 2: Reverse	0	-	○	○	○	X	X	X	○	
06-34	Operation Direction Selection of Speed-Stage 2	0: Stop 1: Forward 2: Reverse	0	-	○	○	○	X	X	X	○	
06-35	Operation Direction Selection of Speed-Stage 3	0: Stop 1: Forward 2: Reverse	0	-	○	○	○	X	X	X	○	
06-36	Operation Direction Selection of Speed-Stage 4	0: Stop 1: Forward 2: Reverse	0	-	○	○	○	X	X	X	○	
06-37	Operation Direction Selection of Speed-Stage 5	0: Stop 1: Forward 2: Reverse	0	-	○	○	○	X	X	X	○	
06-38	Operation Direction Selection of Speed-Stage 6	0: Stop 1: Forward 2: Reverse	0	-	○	○	○	X	X	X	○	
06-39	Operation Direction Selection of Speed-Stage 7	0: Stop 1: Forward 2: Reverse	0	-	○	○	○	X	X	X	○	
06-40	Operation Direction Selection of Speed-Stage 8	0: Stop 1: Forward 2: Reverse	0	-	○	○	○	X	X	X	○	
06-41	Operation Direction Selection of Speed-Stage 9	0: Stop 1: Forward 2: Reverse	0	-	○	○	○	X	X	X	○	
06-42	Operation Direction Selection of Speed-Stage 10	0: Stop 1: Forward 2: Reverse	0	-	○	○	○	X	X	X	○	
06-43	Operation Direction Selection of Speed-Stage 11	0: Stop 1: Forward 2: Reverse	0	-	○	○	○	X	X	X	○	
06-44	Operation Direction Selection of Speed-Stage 12	0: Stop 1: Forward 2: Reverse	0	-	○	○	○	X	X	X	○	
06-45	Operation Direction Selection of Speed-Stage 13	0: Stop 1: Forward 2: Reverse	0	-	○	○	○	X	X	X	○	
06-46	Operation Direction Selection of Speed-Stage 14	0: Stop 1: Forward 2: Reverse	0	-	○	○	○	X	X	X	○	
06-47	Operation Direction Selection of Speed-Stage 15	0: Stop 1: Forward 2: Reverse	0	-	○	○	○	X	X	X	○	

\* If the maximum output frequency of motor is over 300HZ, the frequency resolution is changed to 0.1Hz

Group 07: Start /Stop Parameters												
Code	Parameter Name	Setting Range	Default	Unit	Control mode							Attribute
					V/F	V/F +PG	SLV	SV	PM SV	PM SLV	SLV2	
07-00	Momentary Power Loss/Fault Restart Selection	0: Disable	0	-	O	O	O	O	X	O	O	
		1: Enable										
07-01	Fault Auto-Restart Time	0~7200	0	s	O	O	O	O	O	O	O	
07-02	Number of Fault Auto-Restart Attempts	0~10	0	-	O	O	O	O	O	O	O	
07-03	Reserved											
07-04	Direct Start at Power on	0: When the external run command is enabled, direct start at power up	1	-	O	O	O	O	O	O	O	
		1: When the external run command is enabled, unable to direct start at power-up.										
07-05	Delay of Direct Start at Power on	1.0~300.0	3.5	s	O	O	O	O	O	O	O	
07-06	DC Injection Braking Starting Frequency	0.0~10.0	0.5	Hz	O	O	O	O	O	O	O	
07-07	DC Injection Braking Current	0~100	50	%	O	O	O	X	X	O	O	
07-08	DC Injection Braking Time at Stop	0.00~100.00	0.50	s	O	O	O	O	O	O	O	
07-09	Stop Mode Selection	0: Deceleration to Stop	0	-	O	O	O	O	O	O	O	O
		1: Coast to Stop								O	O	
		2: DC Braking Stop in All Fields								X	X	
		3: Coast to Stop with Timer								O	O	
07-10 ~ 07-12	Reserved											
07-13	Low Voltage Detection Level	200V: 150~300	190	V	O	O	O	O	O	O	O	
		400V: 250~600	380									
		575V: 500~600	546									
		690V: 500~600	546									
07-14	Pre-excitation Time	0.00~10.00	2.00	s	X	X	O	X	X	X	X	
07-15	Pre-excitation Level	50~200	100	%	X	X	O	X	X	X	X	
07-16	DC Injection Braking Time at Start	0.00~100.00	0.00	s	O	O	O	O	O	O	O	
07-17	Reserved											
07-18	Minimum Base block Time	0.1~5.0	-	Sec	O	O	O	O	X	O	O	

**Group 07: Start /Stop Parameters**

Code	Parameter Name	Setting Range	Default	Unit	Control mode							Attribute
					V/F	V/F +PG	SLV	SV	PM SV	PM SLV	SLV2	
07-19	Direction-Detection Speed Search Operating Current	0~100	50	%	O	X	O	X	X	X	O	
07-20	Speed Search Operating Current	0~100	20	%	O	X	O	X	X	X	O	
07-21	Integral Time of Speed Searching	0.1~10.0	2.0	Sec	O	X	O	X	X	X	O	
07-22	Delay Time of Speed Searching	0.0~20.0	0.2	Sec	O	O	O	O	O	X	O	
07-23	Voltage Recovery Time	0.1~5.0	2.0	Sec	O	O	O	X	X	X	O	
07-24	Direction-Detection Speed Search Selection	0: Disable	1	-	O	O	O	X	X	X	O	
		1: Enable										
07-25	Low Voltage Detection Time	0.00~1.00	0.02	Sec	O	O	O	O	O	O	O	
07-26	Start-up Mode Selection of SLV Coast to Stop	0: Start with speed search	0	-	X	X	O	X	X	X	X	
		1: Normal start										
07-27	Start Selection after Fault during SLV Mode	0: Start with speed search	0	-	X	X	O	X	X	X	X	
		1: Normal start										
07-28	Start after External Base Block	0: Start with speed search	0	-	O	X	O	X	X	X	O	
		1: Normal start										
07-29	Run Command Selection at the Action of DC Braking	0: Not Allowable to Run	0	-	O	O	X	X	X	X	X	
		1: Allowable to Run										
07-30	Low Voltage Level Selection	0: Disable	0	-	O	O	O	O	O	O	O	
		1: Enable										
07-31	**Low Voltage Run Frequency	0.00~599.00	10.00	Hz	X	X	X	O	O	X	X	
07-32	Speed Search Mode Selection	0: Disable	0	-	O	O	O	O	X	O	X	
		1: Mode1: Execute a Speed Search at Power On										
		2: Execute a Speed Search each time										
07-33	Start Frequency of Speed Search Selection	0: Maximum Output Frequency of Motor	0	-	O	O	O	O	X	X	X	
		1: Frequency Command										
07-34	Short-circuit braking time at Start	0.00~100.00	0.00	Sec	X	X	X	X	X	O	X	Note1
07-35	Short-circuit braking time at Stop	0.00~100.00	0.50	Sec	X	X	X	X	X	O	X	Note1

Group 07: Start /Stop Parameters												
Code	Parameter Name	Setting Range	Default	Unit	Control mode							Attribute
					V/F	V/F +PG	SLV	SV	PM SV	PM SLV	SLV2	
07-36	Short-circuit braking current limited	0.0~200.0	100.0	%	X	X	X	X	X	O	X	Note1
07-37 ~ 07-41	Reserved											
07-42	Voltage Limit Gain	0.0~50.0	0	%	X	X	O	O	X	X	X	Note2
07-43	Short-circuit Braking Time of PM Speed Search	0.00~100.00	0.00	Sec	X	X	X	X	X	O	X	Note3
07-44	DC Braking Time of PM Speed Search	0.00~100.00	0.00	Sec	X	X	X	X	X	O	X	Note3
07-45	STP2 Function Selection	0: STP2 Enable 1: STP2 Disable	0	-	O	O	O	O	O	O	O	Note4
07-46	DC Injection Current Limit	0~150	100	%	O	X	X	X	X	X	X	Note5
07-47	PM Speed Switching Frequency Mode	0: Disabled 1: Mode 1 2: Mode 2	0	-	X	X	X	X	X	O	X	Note8

**\*07-13 Low Voltage Detection Level, it is enable when 07-30 Low Voltage Level Selection set 0 (Enable) and lower frequency limit set to 250V.This application is for Emergency power supply (EPS)**

**\* \*If the maximum output frequency of motor is over 300HZ, the frequency resolution is changed to 0.1Hz**



**Group 08: Protection Parameters**

Code	Parameter Name	Setting Range	Default	Unit	Control mode							Attribute
					V/F	V/F +PG	SLV	SV	PM SV	PM SLV	SLV2	
08-00	Stall Prevention Function	xxx0b: Stall prevention is enabled in acceleration.	0000b	-	O	O	O	O	O	O	O	
		xxx1b: Stall prevention is disabled in acceleration.										
		xx0xb: Stall prevention is enabled in deceleration.										
		xx1xb: Stall prevention is disabled in deceleration.										
		x0xxb: Stall prevention is enabled in operation										
		x1xxb: Stall prevention is disabled in operation										
		0xxxb: Stall prevention in operation is based on deceleration time of speed-stage 1.										
		1xxxb: Stall prevention in operation is based on deceleration time of speed-stage 2.										
08-01	Stall Prevention Level in Acceleration	20~200	HD:150 ND:120	%	O	O	O	X	X	O	O	
08-02	Stall Prevention Level in Deceleration	200V: 330V~410V	385V	V	O	O	O	O	X	O	O	
		400V: 660V~820V	770V									
		575V: 900~1000	950V									
		690V: 1080~1200	1140V									
08-03	Stall Prevention Level in Operation	30~200	HD:160 ND:120	%	O	O	X	X	X	X	O	
08-04	Reserved											
08-05	Selection for Motor Overload Protection (OL1)	xxx0b: Overload Protection is disabled.	0001b	-	O	O	O	O	O	O	O	
		xxx1b: Overload Protection is enabled.										
		xx0xb: Cold Start of Motor Overload										

**Group 08: Protection Parameters**

Code	Parameter Name	Setting Range	Default	Unit	Control mode							Attribute
					V/F	V/F +PG	SLV	SV	PM SV	PM SLV	SLV2	
		xx1xb: Hot Start of Motor Overload										
		x0xxb: Standard Motor										
		x1xxb: Inverter Duty Motor										
		0xxxb: Reserved										
		1xxxb: Reserved										
08-06	Start-up Mode of Overload Protection Operation (OL1)	0: Stop Output after Overload Protection	0	-	0	0	0	0	0	0	0	
		1: Continuous Operation after Overload Protection.										
08-07	Motor Overload (OL1) Protection Level	0: Motor Overload (OL1) Protection 0	0	-	0	0	0	0	0	0	0	Note2
		1: Motor Overload (OL1) Protection 1										
		2: Motor Overload (OL1) Protection 2										
08-08	Automatic Voltage Regulation (AVR)	0: Enable	0	-	0	0	0	0	0	0	0	
		1: Disable										
08-09	Selection of Input Phase Loss Protection	0: Disable	0	-	0	0	0	0	0	0	0	
		1: Enable										
08-10	Selection of Output Phase Loss Protection	0: Disable	0	-	0	0	0	0	0	0	0	
		1: Enable										
08-11 08-12	Reserved											
08-13	Selection of Over-Torque Detection	0: Over-Torque Detection is Disabled.	0	-	0	0	0	0	0	0	0	
		1: Start to Detect when Reaching the Set Frequency.										
		2: Start to Detect when the Operation is Begun.										
08-14	Selection of Over-Torque Operation	0: Deceleration to Stop when Over Torque is Detected.	0	-	0	0	0	0	0	0	0	
		1: Display Warning when Over Torque is Detected. Go on Operation.										
		2: Coast to Stop when Over Torque is Detected										
08-15	Level of Over-Torque	0~300	150	%	0	0	0	0	0	0	0	

**Group 08: Protection Parameters**

Code	Parameter Name	Setting Range	Default	Unit	Control mode							Attribute	
					V/F	V/F +PG	SLV	SV	PM SV	PM SLV	SLV2		
	Detection												
08-16	Time of Over-Torque Detection	0.0~10.0	0.1	Sec	○	○	○	○	○	○	○		
08-17	Selection of Low-Torque Detection	0: Low-Torque Detection is Disabled.	0	-	○	○	○	○	○	○	○	○	
		1: Start to Detect when Reaching the Set Frequency.											
		2: Start to Detect when the Operation is Begun.											
08-18	Selection of Low-Torque Operation	0: Deceleration to Stop when Low Torque is Detected.	0	-	○	○	○	○	○	○	○	○	
		1: Display Warning when Low Torque is Detected. Go on Operation.											
		2: Coast to Stop when Low Torque is Detected											
08-19	Level of Low-Torque Detection	0~300	30	%	○	○	○	○	○	○	○		
08-20	Time of Low-Torque Detection	0.0~10.0	0.1	Sec	○	○	○	○	○	○	○		
08-21	Limit of Stall Prevention in Acc over Base Speed	1~100	50	%	○	○	○	X	X	○	○		
08-22	Stall Prevention Detection Time in Operation	2~100	100	ms	○	○	○	X	X	○	○		
08-23	Ground Fault (GF) Selection	0: Disable	0	-	○	○	○	○	○	○	○	○	
		1: Enable											
08-24	External Fault Operation Selection	0: Deceleration to Stop	0	-	○	○	○	○	○	○	○	○	
		1: Coast to Stop											
		2: Continuous Operation											
08-25	Detection Selection of External Fault	0: Immediately Detect when the Power is Supplied.	0	-	○	○	○	○	○	○	○	○	
		1: Start to Detect when the Operation is Started.											
08-26 ~ 08-29	Reserved												
08-30	Run Permissive	0: Deceleration to Stop	0	-	○	○	○	○	○	○	○	○	

### Group 08: Protection Parameters

Code	Parameter Name	Setting Range	Default	Unit	Control mode							Attribute	
					V/F	V/F +PG	SLV	SV	PM SV	PM SLV	SLV2		
	Function Selection	1: Coast to Stop											
08-31 ~ 08-34	Reserved												
08-35	Motor Overheating Fault Selection	0: Disable	0	-	O	O	O	O	O	O	O	O	
		1: Deceleration to Stop											
		2: Free Run to top											
		3: Continue Running											
08-36	PTC Input Filter Time Constant	0.00 ~ 5.00	2.00	Sec	O	O	O	O	O	O	O	O	
08-37	Fan Control Function	0: Start in operation	0		O	O	O	O	O	O	O	O	
		1: Permanent Start											
		2: Start in high temperature (Note)											
08-38	Delay Time of Fan Off	0~600	60	s	O	O	O	O	O	O	O	O	
08-39	Delay Time of Motor Overheat Protection	1~300	60	sec	O	O	O	O	O	O	O	O	
08-40	Motor2 Acceleration Stall Prevention Level	20~200	HD:150	%	O	O	O	X	X	O	O	O	
			ND:120										
08-41	Motor2 Acceleration Stall Prevention Limit	1~100	50	%	O	O	O	X	X	O	O	O	
08-42	PTC Protection Level	0.1~10.0V	0.7	V	O	O	O	O	O	O	O	O	
08-43	PTC Restart Level	0.1~10.0V	0.3	V	O	O	O	O	O	O	O	O	
08-44	PTC Warning Level	0.1~10.0V	0.5	V	O	O	O	O	O	O	O	O	
08-45	Reserved												
08-46	Temperature Agree Level	0~254°C	0	° C	O	O	O	O	O	O	O	O	Note4
08-47	Temperature Reset Level	0~254°C	0	° C	O	O	O	O	O	O	O	O	Note4
08-48	Selection of Fire Mode	0: Disable 1: Enable	0	-	O	O	O	O	O	O	O	O	Note4
08-49	Multi-Function Input Terminal Status of Fire Mode	0 : Reset after Power Off 1 : Reset after Terminal Removed	0	-	O	O	O	O	O	O	O	O	Note4
08-50	Multi-Function Terminal Status	XXX0b: S6 A contact XXX1b: S6 B contact	0000b	-	O	O	O	O	O	O	O	O	Note4

**Group 08: Protection Parameters**

Code	Parameter Name	Setting Range	Default	Unit	Control mode							Attribute
					V/F	V/F +PG	SLV	SV	PM SV	PM SLV	SLV2	
	of Fire Mode											
08-51	Motor Speed Setting Source of Fire Mode	0 : Fire Mode Speed (08-52) 1 : PID Control 2 : AI2	0	-	○	○	○	○	○	○	○	Note4
08-52	Motor Speed of Fire Mode	0.00~100.00	100.00	%	○	○	○	○	○	○	○	Note4
08-53	PID Detection Level of Fire Mode	0~100	0	%	○	○	○	○	○	○	○	Note4
08-54	Delay Time of Fire Mode PID Loss	0.0~10.0	1.0	s	○	○	○	○	○	○	○	Note4
08-55	PID Feedback Loss Detection Selection of Fire Mode	0 : Keep Running 1 : Fire Mode Speed (08-52) 2 : Maximum Output Frequency (01-02)	1	-	○	○	○	○	○	○	○	Note4
08-56	Detection Level of Fire Mode AI2 Signal	0.0~100.0	80.0	%	○	○	○	○	○	○	○	Note4
08-57	Delay Time of Fire Mode AI2 Signal Loss	0.0~10.0	1.0	s	○	○	○	○	○	○	○	Note4
08-58	Selection of Fire Mode AI2 Signal Loss	0: Keep Running 1: Fire Mode Speed (08-52) 2: Maximum Output Frequency (01-02)	1	-	○	○	○	○	○	○	○	Note4
08-59	Fire Mode Motor Direction	0: Forward 1: Reverse	0	-	○	○	○	○	○	○	○	Note4
08-60	Fire Mode Password	00000~65534	0	-	○	○	○	○	○	○	○	Note4

**Note: Models of 200V 50HP and 400V 100HP and above don't have this function.**

Group 09: Communication Parameters												
Code	Parameter Name	Setting Range	Default	Unit	Control mode							Attribute
					V/F	V/F +PG	SLV	SV	PM SV	PM SLV	SLV2	
09-00	INV Communication Station Address	1~31	1	-	0	0	0	0	0	0	0	*3
09-01	Communication Mode Selection	0: MODBUS	0		0	0	0	0	0	0	0	*3
09-02	Baud Rate Setting (bps)	0: 1200	4	-	0	0	0	0	0	0	0	*3
		1: 2400										
		2: 4800										
		3: 9600										
		4: 19200										
5: 38400												
09-03	Stop Bit Selection	0: 1 Stop Bit	0	-	0	0	0	0	0	0	0	*3
		1: 2 Stop Bit										
09-04	Parity Selection	0: No Parity	0	-	0	0	0	0	0	0	0	*3
		1: Even Bit										
		2: Odd Bit										
09-05	Communication Data Bit Selection	0: 8 Bit Data	0	-	0	0	0	0	0	0	0	*3
		1: 7 Bit Data										
09-06	Communication Error Detection Time	0.0~25.5	0.0	S	0	0	0	0	0	0	0	*3
09-07	Fault Stop Selection	0: Deceleration to Stop Based on Deceleration Time 1 when Communication Fault Occurs.	3	-	0	0	0	0	0	0	0	*3
		1: Coast to Stop when Communication Fault Occurs.										
		2: Deceleration to Stop Based on Deceleration Time 2 when Communication Fault Occurs.										
		3: Keep Operating when Communication Fault Occurs.										
09-08	Comm. Fault Tolerance Count	1~20	1	-	0	0	0	0	0	0	0	*3
09-09	Waiting Time	5~65	5	ms	0	0	0	0	0	0	0	*3
09-10	Reserved											

\* Parameter 09 does not be influenced by 13-08 (Restore Factory Setting)

**Group 10: PID Parameters**

Code	Parameter Name	Setting Range	Default	Unit	Control mode							Attribute
					V/F	V/F +PG	SLV	SV	PM SV	PM SLV	SLV2	
10-00	PID Target Value Source Setting	1: AI1 given	1	-	0	0	0	0	0	0	0	
		2: AI2 given										
		3: PI given										
		4:10-02 given										
		5: Reserved										
		6: Frequency Command (00-05)										
10-01	PID Feedback Value Source Setting	1: AI1 given	2	-	0	0	0	0	0	0	0	
		2: AI2 given										
		3: PI given										
10-02	PID Target Value	0.00~100.00	0.00	%	0	0	0	0	0	0	0	*1
10-03	PID Control Mode	xxx0b: PID Disable	0000b	-	0	0	0	0	0	0	0	
		xxx1b: PID Enable										
		xx0xb: PID Positive Characteristic										
		xx1xb: PID Negative Characteristic										
		x0xxb: PID Error Value of D Control										
		x1xxb: PID Feedback Value of D Ctrl										
		0xxxb: PID Output										
		1xxxb: PID Output + Frequency Command										
10-04	Feedback Gain	0.01~10.00	1.00	-	0	0	0	0	0	0	0	*1
10-05	Proportional Gain (P)	0.00~10.00	1.00	-	0	0	0	0	0	0	0	*1
10-06	Integral Time (I)	0.00~100.00	1.00	s	0	0	0	0	0	0	0	*1
10-07	Differential Time (D)	0.00~10.00	0.00	s	0	0	0	0	0	0	0	*1
10-08	AI1 Frequency Limit	0.00~599.00	0	Hz	0	0	0	0	0	0	0	Note2
10-09	PID Bias	-100.0~100.0	0	%	0	0	0	0	0	0	0	*1
10-10	PID Output Delay Time	0.00~10.00	0.00	s	0	0	0	0	0	0	0	*1
10-11	PID Feedback Loss Detection Selection	0: Disable	0	-	0	0	0	0	0	0	0	
		1: Warning										
		2: Fault										
10-12	PID Feedback Loss Det. Lev.	0~100	0	%	0	0	0	0	0	0	0	
10-13	PID Feedback Loss Det. Time	0.0~10.0	1.0	s	0	0	0	0	0	0	0	
10-14	PID Integral Limit	0.0~100.0	100.0	%	0	0	0	0	0	0	0	*1
10-15	PID Trim Mode	0~2	0	-	0	0	0	0	0	0	0	Note2
10-16	PID Trim Scale	0~100	0	%	0	0	0	0	0	0	0	Note2
10-17	*Start Frequency of PID Sleep	0.00~599.00	0.00	Hz	0	0	0	0	0	0	0	

Group 10: PID Parameters												
Code	Parameter Name	Setting Range	Default	Unit	Control mode							Attribute
					V/F	V/F +PG	SLV	SV	PM SV	PM SLV	SLV2	
10-18	Delay Time of PID Sleep	0.0~255.5	0.0	s	○	○	○	○	○	○	○	
10-19	*Frequency of PID Waking up	0.00~599.00	0.00	Hz	○	○	○	○	○	○	○	
10-20	Delay Time of PID Waking up	0.0~255.5	0.0	s	○	○	○	○	○	○	○	
10-21 10-22	Reserved											
10-23	PID Output Limit	0.00~100.0	100.0	%	○	○	○	○	○	○	○	*1
10-24	PID Output Gain	0.0~25.0	1.0	-	○	○	○	○	○	○	○	
10-25	PID Reversal Output Selection	0: No Allowing Reversal Output	0	-	○	○	○	○	○	○	○	
		1: Allow Reversal Output										
10-26	PID Target Acceleration/Deceleration Time	0.0~25.5	0.0	s	○	○	○	○	○	○	○	
10-27	PID Feedback Display Bias	0~9999	0	-	○	○	○	○	○	○	○	
10-28	Reserved											
10-29	PID Sleep Selection	0: Disable	1	-	○	○	○	○	○	○	○	
		1: Enable										
		2: set by DI										
10-30	Upper Limit of PID Target	0.0 ~ 100.0	100.0	%	○	○	○	○	○	○	○	
10-31	Lower Limit of PID Target	0.0 ~ 100.0	0.0	%	○	○	○	○	○	○	○	
10-32	Reserved											
10-33	Maximum Value of PID Feedback	1 ~ 10000	999	-	○	○	○	○	○	○	○	
10-34	PID Decimal Width	0 ~ 4	1		○	○	○	○	○	○	○	
10-35	PID Unit	0: %	0		○	○	○	○	○	○	○	*7
		1: FPM										
		2: CFM										
		3: SPI										
		4: GPH										
		5: GPM										
		6: IN										
		7: FT										
		8: /s										
		9: /m										
		10: /h										
		11: °F										
		12: inW										
		13: HP										
14: m/s												



### Group 10: PID Parameters

Code	Parameter Name	Setting Range	Default	Unit	Control mode							Attribute	
					V/F	V/F +PG	SLV	SV	PM SV	PM SLV	SLV2		
		15: MPM											
		16: CMM											
		17: W											
		18: KW											
		19: m											
		20: °C											
		21: RPM											
		22: Bar											
		23: Pa											
		24: KPa											
10-36	Proportional Gain 2 (P)	0.00~10.00	3.00	-	○	○	○	○	○	○	○	○	Note2
10-37	Integral Time 2 (I)	0.00~100.00	0.50	Sec	○	○	○	○	○	○	○	○	Note2
10-38	Differential Time 2 (D)	0.00~10.00	0.00	Sec	○	○	○	○	○	○	○	○	Note2
10-39	*Output Frequency Setting of PID Disconnection	00.00~599.00	30.00	Hz	○	○	○	○	○	○	○	○	
10-40	Selection of PID Sleep Compensation Frequency	0: Disable	0		○	○	○	○	○	○	○	○	
		1: Enable			○	○	○	○	○	○	○	○	
10-41	PID Mode Switch	0: General PID	0	-	○	○	○	○	○	○	○	○	Note2
		1: D Type PID											
10-42 ~ 10-46	Reserved												
10-47	Proportional Gain 3(P)	0.00~10.00	1.00		○	○	○	○	○	○	○	○	Note4
10-48	Integral Time 3(I)	0.00~100.00	1.00	Sec	○	○	○	○	○	○	○	○	Note4
10-49	Differential Time 3(D)	0.00~10.00	0.00	Sec	○	○	○	○	○	○	○	○	Note4

\* If the maximum output frequency of motor is over 300HZ, the frequency resolution is changed to 0.1Hz

**Group 11: Auxiliary Parameters**

Code	Parameter Name	Setting Range	Default	Unit	Control mode							Attribute	
					V/F	V/F +PG	SLV	SV	PM SV	PM SLV	SLV2		
11-00	Direction Lock Selection	0: Allow Forward and Reverse Rotation	0	-	○	○	○	○	○	○	○	○	
		1: Only Allow Forward Rotation											
		2: Only Allow Reverse Rotation											
11-01	Carrier frequency	0: Carrier Output Frequency Tuning 1~16: 1~16KHz	*	-	○	○	○	○	○	○	○	○	*1
11-02	Soft PWM Function Selection	0: Disable	0	-	○	○	○	○	○	○	○	○	
		1: Soft PWM 1 enables											
		2: Soft PWM 2 enables											
11-03	Automatic carrier lowering selection	0: Disable	0	-	○	○	X	X	X	X	○		
		1: Enable											
11-04	S-curve Time Setting at the Start of Acceleration	0.00~2.50	0.20	s	○	○	○	○	○	○	○	○	
11-05	S-curve Time Setting at the Stop of Acceleration	0.00~2.50	0.20	s	○	○	○	○	○	○	○	○	
11-06	S-curve Time Setting at the Start of Deceleration	0.00~2.50	0.20	s	○	○	○	○	○	○	○	○	
11-07	S-curve Time Setting at the Stop of Deceleration	0.00~2.50	0.20	s	○	○	○	○	○	○	○	○	
11-08	Jump Frequency 1	0.0~599.0	0.0	Hz	○	○	○	○	○	○	○	○	
11-09	Jump Frequency 2	0.0~599.0	0.0	Hz	○	○	○	○	○	○	○	○	
11-10	Jump Frequency 3	0.0~599.0	0.0	Hz	○	○	○	○	○	○	○	○	
11-11	Jump Frequency Width	0.0~25.5	1.0	Hz	○	○	○	○	○	○	○	○	
11-12	Manual Energy Saving Gain	0~100	80	%	○	○	X	X	X	X	X	X	
11-13	Automatic Return Time	0~120	60	Sec	○	○	○	○	○	○	○	○	*1
11-14 ~ 11-17	Reserved												
11-18	Manual Energy Saving Frequency	0.0~599.0	0.00	Hz	○	○	X	X	X	X	X	X	
11-19	Automatic Energy Saving Function	0: Automatic energy saving is disabled.	0	-	○	X	X	X	X	X	X	X	
		1: Automatic energy saving is enabled.											
11-20	Filter Time of Automatic Energy Saving	0~200	140	ms	○	X	X	X	X	X	X	X	
11-21	Voltage Upper	0~100	100	%	○	X	X	X	X	X	X	X	

**Group 11: Auxiliary Parameters**

Code	Parameter Name	Setting Range	Default	Unit	Control mode							Attribute	
					V/F	V/F +PG	SLV	SV	PM SV	PM SLV	SLV2		
	Limit of Energy Saving Tuning												
11-22	Adjustment Time of Automatic Energy Saving	0~5000	20	ms	O	X	X	X	X	X	X	X	*1
11-23	Detection Level of Automatic Energy Saving	0~100	10	%	O	X	X	X	X	X	X	X	
11-24	Coefficient of Automatic Energy Saving	0.00~655.34 (Note4)	-	-	O	X	X	X	X	X	X	X	
11-25	Reserved												
11-26	Carrier Output Frequency Tuning Upper Limit (%)	10~100	80	%	O	X	X	X	X	X	O	X	
11-27	Carrier Output Frequency Tuning Lower Limit (%)	2~100	20	%	O	X	X	X	X	X	O	X	
11-28	Frequency Gain of Over Voltage Prevention 2	1~200	100	%	O	O	X	X	X	X	X	X	
11-29	Auto De-rating Selection	0: Disable 1: Enable	0	-	O	X	X	X	X	X	X	O	
11-30	Variable Carrier Frequency Upper Limit	2~16	-	KHz	O	O	X	X	X	X	X	O	
11-31	Variable Carrier Frequency Lower Limit	1~16	-	KHz	O	O	X	X	X	X	X	O	
11-32	Variable Carrier Frequency Proportional Gain	00~99	00	-	O	O	X	X	X	X	X	O	
11-33	DC Voltage Filter Rise Amount	0.1~10.0	0.1	Vdc	O	O	X	X	X	X	X	X	*1
11-34	DC Voltage Filter Fall Amount	0.1~10.0	5.0	Vdc	O	O	X	X	X	X	X	X	*1
11-35	DC Voltage Filter Dead band Level	0.0~99.0	10.0	Vdc	O	O	X	X	X	X	X	X	*1
11-36	Frequency Gain of OV Prevention	0.000~1.000	0.050	-	O	O	X	X	X	X	X	X	*1
11-37	**Frequency Limit of OV Prevention	0.00~599.00	5.00	Hz	O	O	X	X	X	X	X	X	
11-38	Deceleration Start Voltage of OV Prevention	200V: 200~400V	300	V	O	O	X	X	X	X	X	X	
		400V: 400~800V	700										
		575V: 500~1000V	900										
		690V: 600~1200V	1080										
11-39	Deceleration Stop Voltage of OV Prevention	200V: 300~400V	350	V	O	O	X	X	X	X	X	X	
		400V: 600~800V	750										
		575V: 500~1000V	950										
		690V: 600~1200V	1140										

**Group 11: Auxiliary Parameters**

Code	Parameter Name	Setting Range	Default	Unit	Control mode							Attribute
					V/F	V/F +PG	SLV	SV	PM SV	PM SLV	SLV2	
11-40	OV Prevention Selection	0: Disable 1: OV Prevention Mode 1 2: OV Prevention Mode 2 3: OV Prevention Mode 3	0	-	O	O	X	X	X	X	X	
11-41	Selection of Reference Frequency Disappearance Detection	0: Decelerate to Stop when Reference Frequency Disappears 1: Operation is set by Parameter 11-42 when Reference Frequency Disappears	0	-	O	O	O	O	O	O	O	
11-42	Disappearance Level of Reference Frequency	0.0~100.0	80.0	%	O	O	O	O	O	O	O	
11-43	Hold Frequency at Start	0.0~599.0	0.0	Hz	O	O	O	O	O	O	O	
11-44	Frequency Hold Time at Start	0.0~10.0	0.0	s	O	O	O	O	O	O	O	
11-45	Hold Frequency at Stop	0.0~599.0	0.0	Hz	O	O	O	O	O	O	O	
11-46	Frequency Hold Time at Stop	0.0~10.0	0.0	s	O	O	O	O	O	O	O	
11-47	KEB Deceleration Time	0.0~25.5	0.0	s	O	O	X	X	X	X	O	*1
11-48	KEB Detection Level	200V: 190~210	200	V	O	O	X	X	X	X	X	O
		400V: 380~420	400									
		575V: 540~570	555									
		690V: 540~684	555									
11-49	Zero-servo Gain	0.01~5.00	1.00	-	X	X	X	O	O	X	X	
11-50	Zero-servo Count	0~4096	12	-	X	X	X	O	O	X	X	
11-51	Braking Selection of Zero Speed	0: Disable 1: Enable	0	-	O	X	X	X	X	X	O	
11-52	Droop Control Level	0.0~100.0%	0.0	%	X	X	O (Note4)	O	O	O (Note4)	X	*1
11-53	Droop Control Delay	0.01~2.00	0.2	s	X	X	O (Note4)	O	O	O (Note4)	X	*1
11-54	Initialization of Cumulative Energy	0: Do not Clear Cumulative Energy 1: Clear Cumulative Energy	0	-	O	O	O	O	O	O	O	*1
11-55	STOP Key Selection	0: Stop Key is Disabled when the Operation Command is not Provided by Operator.	1	-	O	O	O	O	O	O	O	

**Group 11: Auxiliary Parameters**

Code	Parameter Name	Setting Range	Default	Unit	Control mode							Attribute	
					V/F	V/F +PG	SLV	SV	PM SV	PM SLV	SLV2		
		1: Stop Key is Enabled when the Operation Command is not Provided by Operator.											
11-56	UP/DOWN Selection	0: When UP/DOWN in Keypad is Disabled, it will be Enabled if Pressing ENTER after Frequency Modification. 1: When UP/DOWN in Keypad is Enabled, it will be Enabled upon Frequency Modification.	0	-	○	○	○	○	○	○	○		
11-57	Reserved												
11-58	Record Reference Frequency	0: Disable 1: Enable	0	-	○	○	○	○	○	○	○	○	*1
11-59	Gain of Preventing Oscillation	0.00~2.50	*		○	○	X	X	X	X	○		
11-60	Upper Limit of Preventing Oscillation	0~100	*	%	○	○	X	X	X	X	○		
11-61	Time Parameter of Preventing Oscillation	0~100	0		○	○	X	X	X	X	○		
11-62	Selection of Preventing Oscillation	0: Mode1 1: Mode2 2: Mode3	1		○	○	X	X	X	X	○		
11-63	Strong Magnetic Selection	0: Disable 1: Enable	1		X	X	○	○	X	X	X		
11-64	Acceleration Speed Gain Adjustment	0.1~10.0	1.0	-	○	X	X	X	X	X	○		
11-65	Target Main Circuit Voltage	200V: 200V~400V	370	-	○	X	X	X	X	X	○		
		400V: 400V~800V	740										
		575V: 520V~1040V	962										
		690V: 624V~1248V	1154										
11-66	2 Phase/ 3 Phase PWM Switch Frequency	6.00~60.00	20	Hz	X	X	○	○	X	○	○	Note2	
11-67	Soft PWM 2 Frequency Range	0~12000	0	Hz	X	X	○	○	○	○	X	Note2	

Group 11: Auxiliary Parameters												
Code	Parameter Name	Setting Range	Default	Unit	Control mode							Attribute
					V/F	V/F +PG	SLV	SV	PM SV	PM SLV	SLV2	
11-68	Soft PWM 2 Switch Frequency	6.00~60.00	20	Hz	X	X	O	O	O	O	X	Note2
11-69	Gain of Preventing Oscillation 3	0.00~200.00	5.00	%	O	O	X	X	X	X	X	Note1
11-70	Upper Limit of Preventing Oscillation 3	0.01~100.00	5.00	%	O	O	X	X	X	X	X	Note1
11-71	Time Parameter of Preventing Oscillation 3	0~30000	100	ms	O	O	X	X	X	X	X	Note1
11-72	Gain of Preventing Oscillation for switch frequency 1	0.01~300.00	30.00	Hz	O	O	X	X	X	X	X	Note1
11-73	Gain of Preventing Oscillation for switch frequency 2	0.01~300.00	50.00	Hz	O	O	X	X	X	X	X	Note1
11-76	Droop Frequency Level 1	0.00~599.00	0.00	Hz	X	X	O	O	O	O	X	Note4
11-77	Droop Frequency Level 2	0.00~599.00	0.00	Hz	X	X	O	O	O	O	X	Note4
11-78	Droop Torque Offset Value	0.00~100.00	0.00	%	X	X	O	O	O	O	X	Note4
11-79	LOC/REM Keypad Button Selection	0: Forward / Reverse control 1: Local / Remote control	1	-	O	O	O	O	O	O	O	
11-80	Local / Remote Selection Mode	0: Allow Switching Directly 1: Switching Prohibited at Running 2: Stop after Switching	0	-	O	X	O	O	O	O	O	
11-81	OVP4 Level (%)	100~200	110	%	O	O	O	O	X	X	O	
11-82	OVP4 Gain	0~256	64	-	O	O	O	O	X	X	O	



\*: Refer to the attachment 1.

\*\* If the maximum output frequency of motor is over 300HZ, the frequency resolution is changed to 0.1Hz

Note: The parameter of 11-01 can be changed during run operation, the range is 1~16KHz.

Group 12: Monitoring Parameters													
Code	Parameter Name	Setting Range	Default	Unit	Control mode							Attribute	
					V/F	V/F +PG	SLV	SV	PM SV	PM SLV	SLV2		
12-00	Display Screen Selection (LED)	00000~77777 From the leftmost bit, it displays the screen when press DSP key in order. 0:no display 1: Output Current 2: Output Voltage 3: DC Bus Voltage 4: Heatsink Temperature* 5: PID Feedback 6: AI1 Value 7: AI2 Value	00321 (Note4)	-		0	0	0	0	0	0	0	*1 *6
12-01	PID Feedback Display Mode (LED)	0: Display the Feedback Value by Integer (xxx)	0			0	0	0	0	0	0	0	*6
		1: Display the Feedback Value by the Value with One Decimal Place (xx.x)											
		2: Display the Feedback Value by the Value with Two Decimal Places (x.xx)											
12-02	PID Feedback Display Unit Setting (LED)	0: xxxxx (no unit)	0			0	0	0	0	0	0	0	*6
		1: xxxPb (pressure)											
		2: xxxFL (flow)											
12-03	Line Speed Display (LED)	0~60000	1500/ 1800	RPM		0	0	0	0	0	0	0	*6
12-04	Modes of Line Speed Display (LED)	0: Display Inverter Output Frequency	0	-		0	0	0	0	0	0	0	*1 *6
		1: Display Line Speed with integer (xxxxx)											
		2: Display Line Speed with the First Decimal Place (xxxx.x)											
		3: Display Line Speed with the Second Decimal Place (xxx.xx)											
		4: Display Line Speed with the Third Decimal Place (xx.xxx)											

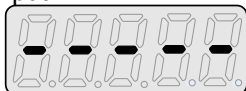
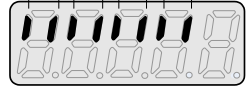
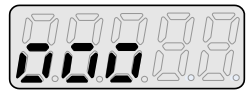
**Group 12: Monitoring Parameters**

Code	Parameter Name	Setting Range	Default	Unit	Control mode						Attribute	
					V/F	V/F +PG	SLV	SV	PM SV	PM SLV		SLV2
12-05	Status Display of Digital Input & Output Terminal (LED / LCD)	<p>LED display is shown as below no input</p>  <p>correspondences to input and output</p> <p>S1 S2 S3 S4 S5 S6 S7 S8</p>   <p>R1 R2 DO1</p> <p>LCD display is shown as below</p>  <p>0 : OPEN 1 : CLOSE</p> <ul style="list-style-type: none"> <li>Input Terminal(S8)</li> <li>Input Terminal(S7)</li> <li>Input Terminal(S6)</li> <li>Input Terminal(S5)</li> <li>Input Terminal(S4)</li> <li>Input Terminal(S3)</li> <li>Input Terminal(S2)</li> <li>Input Terminal(S1)</li> <li>Output Terminal(DO1)</li> <li>Output Terminal(R2)</li> <li>Output Terminal(R1)</li> </ul>	-		O	O	O	O	O	O	O	
12-06 ~ 12-10	Reserved											
12-11	Output Current of Current Fault	Display the output current of current fault	-	A	O	O	O	O	O	O	O	
12-12	Output Voltage of Current Fault	Display the output voltage of current fault	-	V	O	O	O	O	O	O	O	
12-13	Output Frequency of Current Fault	Display the output frequency of current fault	-	Hz	O	O	O	O	O	O	O	
12-14	DC Voltage of Current Fault	Display the DC voltage of current fault	-	V	O	O	O	O	O	O	O	
12-15	Frequency Command of Current Fault	Display the frequency command of current fault	-	Hz	O	O	O	O	O	O	O	
12-16	Frequency Command	If LED enters this parameter, it only allows monitoring frequency command.	-	Hz	O	O	O	O	O	O	O	
12-17	Output Frequency	Display the current output frequency	-	Hz	O	O	O	O	O	O	O	
12-18	Output Current	Display the current output current	-	A	O	O	O	O	O	O	O	



**Group 12: Monitoring Parameters**

Code	Parameter Name	Setting Range	Default	Unit	Control mode							Attribute
					V/F	V/F +PG	SLV	SV	PM SV	PM SLV	SLV2	
12-19	Output Voltage	Display the current output voltage	-	V	O	O	O	O	O	O	O	
12-20	DC Voltage (Vdc)	Display the current DC voltage	-	V	O	O	O	O	O	O	O	
12-21	Output Power (kw)	Display the current output power	-	kW	O	O	O	O	O	O	O	
12-22	Motor's Rotation Speed (rpm)	Display motor's current rotation speed in VF/SLV mode Motor's rotation speed = output frequency x(120/motor's pole number) In PG/SV mode, motor's rotation speed is calculated by feedback frequency. Max limit is 65535	-	rpm	O	O	O	O	O	O	O	
12-23	Output Power Factor (Pfo)	Display the current output power factor	-	-	O	O	O	O	O	O	O	
12-24	Control Mode	Display control mode 0: VF 1: PG 2: SLV 3: SV 4: PSV 5: PMSLV 6: SLV2	-	-	O	O	O	O	O	O	O	
12-25	AI1 Input	Display the current AI1 input (-10V corresponds to -100%, 10V corresponds to 100%,)	-	%	O	O	O	O	O	O	O	
12-26	AI2 Input	Display the current AI2 input (0V or 4mA corresponds to 0%, 10V or 20mA corresponds to 100%)	-	%	O	O	O	O	O	O	O	
12-27	Motor Torque	Display the current torque command (100% corresponds to motor torque )	-	%	X	X	O	O	O	O	X	
12-28	Motor Torque Current (Iq)	Display the current q-axis current	-	%	X	X	O	O	O	O	X	
12-29	Motor Excitation Current (Id)	Display the current d-axis current	-	%	X	X	O	O	O	O	X	
12-30	ASR Deviation	Display deviation of speed controller (speed command - speed feedback) (100% corresponds to the	-	%	X	O	X	O	O	X	X	

**Group 12: Monitoring Parameters**

Code	Parameter Name	Setting Range	Default	Unit	Control mode							Attribute	
					V/F	V/F +PG	SLV	SV	PM SV	PM SLV	SLV2		
		maximum frequency set by 01-02 )											
12-31	Reserved												
12-32	ASR Output	Display output value of speed controller (100% corresponds to the maximum frequency set by 01-02)	-	%	X	O	X	O	O	X	X		
12-33	PG Feedback	Display feedback's speed value of speed controller (100% corresponds to the maximum frequency set by 01-02)	-	%	X	O	X	O	O	X	X		
12-34	PG Pulse Number	Display PG pulse number of speed controller	-	Pulse	X	O	X	O	O	X	X	Note4	
12-35	Zero-speed Servo Pulse Number	When SV position mode, display the position error pulse number of the zero-speed servo (the resolution is four times of pulse number of set values of 20-27)	-	Pulse	X	X	X	O	O	X	X		
12-36	PID Input	Display input error of the PID controller (PID target value - PID feedback) (100% corresponds to the maximum frequency set by 01-02 or 01-16)	-	%	O	O	O	O	O	O	O		
12-37	PID Output	Display output of the PID controller (100% corresponds to the maximum frequency set by 01-02 or 01-16)	-	%	O	O	O	O	O	O	O		
12-38	PID Setting	Display the target value of the PID controller (100% corresponds to the maximum frequency set by 01-02 or 01-16)	-	%	O	O	O	O	O	O	O		
12-39	PID Feedback	Display the feedback value of the PID controller (100% corresponds to the maximum frequency set by 01-02 or 01-16)	-	%	O	O	O	O	O	O	O		
12-40	Reserved												
12-41	Heatsink Temperature*	Display the heatsink temperature of IGBT temperature**	*	°C	O	O	O	O	O	O	O		

**Group 12: Monitoring Parameters**

Code	Parameter Name	Setting Range	Default	Unit	Control mode							Attribute
					V/F	V/F +PG	SLV	SV	PM SV	PM SLV	SLV2	
12-42	RS-485 Error Code		-	-	0	0	0	0	0	0	0	
12-43	Inverter Status		-	-	0	0	0	0	0	0	0	
12-44	Pulse Input Frequency	Display the frequency value of pulse input	-	Hz	0	0	0	0	0	0	0	
12-45	Recent Fault Message	Display current fault message	-	-	0	0	0	0	0	0	0	
12-46	Previous Fault Message	Display previous fault message	-	-	0	0	0	0	0	0	0	
12-47	Previous Two Fault Messages	Display previous two fault messages	-	-	0	0	0	0	0	0	0	
12-48	Previous Three Fault Messages	Display previous three fault messages	-	-	0	0	0	0	0	0	0	
12-49	Previous Four Fault Messages	Display previous four fault messages	-	-	0	0	0	0	0	0	0	
12-50	DIO Status of Current Fault	Display the DI/DO status of current fault Description is similar to 12-05	-	-	0	0	0	0	0	0	0	
12-51	Inverter Status of Current Fault	Display the inverter status of current fault Description is similar to 12-43	-	-	0	0	0	0	0	0	0	
12-52	Trip Time 1 of Current Fault	Display the operation time of current fault, 12-53 is the days, while 12-52 is the remaining hours.	-	Hr	0	0	0	0	0	0	0	
12-53	Trip Time 2 of Current Fault		-	day	0	0	0	0	0	0	0	
12-54	Frequency Command of Previous Fault	Display frequency command of previous fault	-	Hz	0	0	0	0	0	0	0	
12-55	Output Frequency of Previous Fault	Display output frequency of previous fault	-	Hz	0	0	0	0	0	0	0	
12-56	Output Current of Previous Fault	Display output current of previous fault	-	A	0	0	0	0	0	0	0	
12-57	Output Voltage of Previous Fault	Display output voltage of previous fault	-	V	0	0	0	0	0	0	0	
12-58	DC Voltage of Previous Fault	Display DC voltage of previous fault	-	V	0	0	0	0	0	0	0	

Group 12: Monitoring Parameters												
Code	Parameter Name	Setting Range	Default	Unit	Control mode							Attribute
					V/F	V/F +PG	SLV	SV	PM SV	PM SLV	SLV2	
12-59	DIO Status of Previous Fault	Display DI/DO status of previous fault Description is similar to 12-05	-	-	O	O	O	O	O	O	O	
12-60	Inverter Status of Previous Fault	Display inverter status of previous fault Description is similar to 12-43	-	-	O	O	O	O	O	O	O	
12-61	Trip Time 1 of Last Fault	Display the operation time of last time's fault, 12-62 is the days, while 12-61 is the remaining hours.	-	Hr	O	O	O	O	O	O	O	
12-62	Trip Time 2 of Last Fault		-	day	O	O	O	O	O	O	O	
12-63	Recent Warning Messages	Display the recent warning messages	-	-	O	O	O	O	O	O	O	
12-64	Previous Warning Message	Display the previous warning message	-	-	O	O	O	O	O	O	O	
12-65	Motor Start Angle	0~360	-	-	X	X	X	X	O	X	X	
12-66	Encoder Angle	0~360	-	-	X	O	X	O	O	X	X	
12-67	Cumulative Energy (KWHr)	0.0 ~ 999.9		kWHr	O	O	O	O	O	O	O	
12-68	Cumulative Energy (MWHr)	0 ~ 60000		MWHr	O	O	O	O	O	O	O	
12-69 ~ 12-71	Reserved											
12-72	RTC Date	12.01.01 ~ 99.12.31	12.01.01		O	O	O	O	O	O	O	
12-73	RTC Time	00:00 ~ 23:59	00:00		O	O	O	O	O	O	O	
12-76	No-Load Voltage Output	0.0~600.0	-	V	X	X	O	X	X	X	X	
12-77	Reserved											
12-78	Z-Phase Bias Value	-9999~9999	-	Pulse	X	X	X	O	O	X	X	
12-79	Pulse Input Percentage	0.0~100.0	-	%	O	O	O	O	O	O	O	
12-80	AI1 Frequency Command	0.0~599.0	0	Hz	O	O	O	O	O	O	O	Note2
12-81	Reserved											
12-82	Motor Load	0~200.0	-	%	O	O	O	O	O	O	O	Note4
12-85	AI3 Input	Display the current AI3 input (-10V corresponds to -100%, 10V corresponds to 100%)	-	%	O	O	O	O	O	O	O	*10

\*: Refer to the following attachment 1

\*\* A510s 200V 50HP (and the above) and 400V 100HP (and the above) don't support heatsink temperature display function.

Group 13: Maintenance Parameters												
Code	Parameter Name	Setting Range	Default	Unit	Control mode							Attribute
					V/F	V/F +PG	SLV	SV	PM SV	PM SLV	SLV2	
13-00	Inverter Capacity Selection	----	-	-	○	○	○	○	○	○	○	*4
13-01	Software Version	0.00-9.99	-	-	○	○	○	○	○	○	○	*4
13-02	Clear Cumulative Operation Hours	0: Disable to Clear Cumulative Operation Hours 1: Clear Cumulative Operation Hours	0	-	○	○	○	○	○	○	○	*1
13-03	Cumulative Operation Hours 1	0~23	-	hr	○	○	○	○	○	○	○	*4
13-04	Cumulative Operation Hours 2	0~65534 (Note4)	-	day	○	○	○	○	○	○	○	*4
13-05	Selection of Cumulative Operation Time	0: Cumulative time in power on 1: Cumulative time in operation	0	-	○	○	○	○	○	○	○	*1
13-06	Parameters Locked	0: Parameters are read-only except 13-06 and main frequency 1 : User defined parameters 2: All Parameters are Writable	2	-	○	○	○	○	○	○	○	*1
13-07	Parameter Password Function	00000~65534	00000	-	○	○	○	○	○	○	○	Note2
13-08	Restore Factory Setting	0 : No initialization 2 : 2 wire initialization (60Hz)(220/440V/690V) 3 : 3 wire initialization (60Hz)(220/440V/690V) 4 : 2 wire initialization (50Hz)(230/415V) 5 : 3 wire initialization (50Hz)(230/415V) 6 : 2 wire initialization (50Hz)(200/380V/575V) 7 : 3 wire initialization (50Hz)(200/380V/575V) 8 : PLC initialization 9: 2 wire Initialization (60Hz)(230/460V) 10: 3 wire Initialization (60Hz)(230/460V) 11: 2 wire Initialization (60Hz)(230/400V) 12: 3 wire Initialization (60Hz)(230/400V)	-	-	○	○	○	○	○	○	○	

**Group 13: Maintenance Parameters**

Code	Parameter Name	Setting Range	Default	Unit	Control mode							Attribute
					V/F	V/F +PG	SLV	SV	PM SV	PM SLV	SLV2	
		13: 2 wire Initialization (50Hz)(230/400V) 14: 3 wire Initialization (50Hz)(230/400V) 15: 2 wire Initialization (50Hz)(220/380V) (Note4) 16: 3 wire Initialization (50Hz)(220/380V) (Note4)										
13-09	Fault History Clearance Function	0: No Clearing Fault History 1: Clear Fault History	0	-	○	○	○	○	○	○	○	*1
13-10	Parameter Password Function 2	0 ~ 9999	0		○	○	○	○	○	○	○	
13-11	C/B CPLD Ver.	0.00~9.99	-		○	○	○	○	○	○	○	
13-12	PG Card Id	0~255	0		○	○	○	○	○	○	○	*5
13-13	PG Card Ver.	0.00~9.99	-		○	○	○	○	○	○	○	*5
13-14	Fault Storage Selections	0: Fault Messages of Auto Restart are not saved. 1: Fault Messages of Auto Restart are saved.	0		○	○	○	○	○	○	○	
13-15	Reserved											
13-21	Last time Fault History	Exhibit Last time Fault History	-	-	○	○	○	○	○	○	○	Note1
13-22	Previous two Fault History	Exhibit Previous two Fault History	-	-	○	○	○	○	○	○	○	Note1
13-23	Previous three Fault History	Exhibit Previous three Fault History	-	-	○	○	○	○	○	○	○	Note1
13-24	Previous four Fault History	Exhibit Previous four Fault History	-	-	○	○	○	○	○	○	○	Note1
13-25	Previous five Fault History	Exhibit Previous five Fault History	-	-	○	○	○	○	○	○	○	Note1
13-26	Previous six Fault History	Exhibit Previous six Fault History	-	-	○	○	○	○	○	○	○	Note1
13-27	Previous seven Fault History	Exhibit Previous seven Fault History	-	-	○	○	○	○	○	○	○	Note1
13-28	Previous eight Fault History	Exhibit Previous eight Fault History	-	-	○	○	○	○	○	○	○	Note1
13-29	Previous nine Fault History	Exhibit Previous nine Fault History	-	-	○	○	○	○	○	○	○	Note1
13-30	Previous ten Fault History	Exhibit Previous ten Fault History	-	-	○	○	○	○	○	○	○	Note1

**Group 13: Maintenance Parameters**

Code	Parameter Name	Setting Range	Default	Unit	Control mode							Attribute
					V/F	V/F +PG	SLV	SV	PM SV	PM SLV	SLV2	
13-31	Previous eleven Fault History	Exhibit Previous eleven Fault History	-	-	0	0	0	0	0	0	0	Note1
13-32	Previous twelve Fault History	Exhibit Previous twelve Fault History	-	-	0	0	0	0	0	0	0	Note1
13-33	Previous thirteen Fault History	Exhibit Previous thirteen Fault History	-	-	0	0	0	0	0	0	0	Note1
13-34	Previous fourteen Fault History	Exhibit Previous fourteen Fault History	-	-	0	0	0	0	0	0	0	Note1
13-35	Previous fifteen Fault History	Exhibit Previous fifteen Fault History	-	-	0	0	0	0	0	0	0	Note1
13-36	Previous sixteen Fault History	Exhibit Previous sixteen Fault History	-	-	0	0	0	0	0	0	0	Note1
13-37	Previous seventeen Fault History	Exhibit Previous seventeen Fault History	-	-	0	0	0	0	0	0	0	Note1
13-38	Previous eighteen Fault History	Exhibit Previous eighteen Fault History	-	-	0	0	0	0	0	0	0	Note1
13-39	Previous nineteen Fault History	Exhibit Previous nineteen Fault History	-	-	0	0	0	0	0	0	0	Note1
13-40	Previous twenty Fault History	Exhibit Previous twenty Fault History	-	-	0	0	0	0	0	0	0	Note1
13-41	Previous twenty one Fault History	Exhibit Previous twenty one Fault History	-	-	0	0	0	0	0	0	0	Note1
13-42	Previous twenty two Fault History	Exhibit Previous twenty two Fault History	-	-	0	0	0	0	0	0	0	Note1
13-43	Previous twenty three Fault History	Exhibit Previous twenty three Fault History	-	-	0	0	0	0	0	0	0	Note1
13-44	Previous twenty four Fault History	Exhibit Previous twenty four Fault History	-	-	0	0	0	0	0	0	0	Note1
13-45	Previous twenty five Fault History	Exhibit Previous twenty five Fault History	-	-	0	0	0	0	0	0	0	Note1
13-46	Previous twenty six Fault History	Exhibit Previous twenty six Fault History	-	-	0	0	0	0	0	0	0	Note1
13-47	Previous twenty seven Fault History	Exhibit Previous twenty seven Fault History	-	-	0	0	0	0	0	0	0	Note1
13-48	Previous twenty eight Fault History	Exhibit Previous twenty eight Fault History	-	-	0	0	0	0	0	0	0	Note1
13-49	Previous twenty nine Fault History	Exhibit Previous twenty nine Fault History	-	-	0	0	0	0	0	0	0	Note1
13-50	Previous thirty Fault History	Exhibit Previous thirty Fault History	-	-	0	0	0	0	0	0	0	Note1

Note: Main frequency setting is 12-16 in LCD. It's equal to Frequency Setting of Speed-Stage 0 (05-01)

**Group 14: PLC Setting Parameters**

Code	Parameter Name	Setting Range	Default	Unit	Control mode							Attribute
					V/F	V/F +PG	SLV	SV	PM SV	PM SLV	SLV2	
14-00	T1 Set Value 1	0~9999	0	-	○	○	○	○	○	○	○	Note6
14-01	T1 Set Value 2 (Mode 7)	0~9999	0	-	○	○	○	○	○	○	○	Note6
14-02	T2 Set Value 1	0~9999	0	-	○	○	○	○	○	○	○	Note6
14-03	T2 Set Value 2 (Mode 7)	0~9999	0	-	○	○	○	○	○	○	○	Note6
14-04	T3 Set Value 1	0~9999	0	-	○	○	○	○	○	○	○	Note6
14-05	T3 Set Value 2 (Mode 7)	0~9999	0	-	○	○	○	○	○	○	○	Note6
14-06	T4 Set Value 1	0~9999	0	-	○	○	○	○	○	○	○	Note6
14-07	T4 Set Value 2 (Mode 7)	0~9999	0	-	○	○	○	○	○	○	○	Note6
14-08	T5 Set Value 1	0~9999	0	-	○	○	○	○	○	○	○	Note6
14-09	T5 Set Value 2 (Mode 7)	0~9999	0	-	○	○	○	○	○	○	○	Note6
14-10	T6 Set Value 1	0~9999	0	-	○	○	○	○	○	○	○	Note6
14-11	T6 Set Value 2 (Mode 7)	0~9999	0	-	○	○	○	○	○	○	○	Note6
14-12	T7 Set Value 1	0~9999	0	-	○	○	○	○	○	○	○	Note6
14-13	T7 Set Value 2 (Mode 7)	0~9999	0	-	○	○	○	○	○	○	○	Note6
14-14	T8 Set Value 1	0~9999	0	-	○	○	○	○	○	○	○	Note6
14-15	T8 Set Value 2 (Mode 7)	0~9999	0	-	○	○	○	○	○	○	○	Note6
14-16	C1 Set Value	0~65534 (Note4)	0	-	○	○	○	○	○	○	○	Note6
14-17	C2 Set Value	0~65534 (Note4)	0	-	○	○	○	○	○	○	○	Note6
14-18	C3 Set Value	0~65534 (Note4)	0	-	○	○	○	○	○	○	○	Note6
14-19	C4 Set Value	0~65534 (Note4)	0	-	○	○	○	○	○	○	○	Note6
14-20	C5 Set Value	0~65534 (Note4)	0	-	○	○	○	○	○	○	○	Note6
14-21	C6 Set Value	0~65534 (Note4)	0	-	○	○	○	○	○	○	○	Note6
14-22	C7 Set Value	0~65534 (Note4)	0	-	○	○	○	○	○	○	○	Note6
14-23	C8 Set Value	0~65534 (Note4)	0	-	○	○	○	○	○	○	○	Note6
14-24	AS1 Set Value 1	0~65534 (Note4)	0	-	○	○	○	○	○	○	○	Note6
14-25	AS1 Set Value 2	0~65534 (Note4)	0	-	○	○	○	○	○	○	○	Note6
14-26	AS1 Set Value 3	0~65534 (Note4)	0	-	○	○	○	○	○	○	○	Note6
14-27	AS2 Set Value 1	0~65534 (Note4)	0	-	○	○	○	○	○	○	○	Note6
14-28	AS2 Set Value 2	0~65534 (Note4)	0	-	○	○	○	○	○	○	○	Note6
14-29	AS2 Set Value 3	0~65534 (Note4)	0	-	○	○	○	○	○	○	○	Note6
14-30	AS3 Set Value 1	0~65534 (Note4)	0	-	○	○	○	○	○	○	○	Note6
14-31	AS3 Set Value 2	0~65534 (Note4)	0	-	○	○	○	○	○	○	○	Note6
14-32	AS3 Set Value 3	0~65534 (Note4)	0	-	○	○	○	○	○	○	○	Note6
14-33	AS4 Set Value 1	0~65534 (Note4)	0	-	○	○	○	○	○	○	○	Note6
14-34	AS4 Set Value 2	0~65534 (Note4)	0	-	○	○	○	○	○	○	○	Note6
14-35	AS4 Set Value 3	0~65534 (Note4)	0	-	○	○	○	○	○	○	○	Note6



### Group 14: PLC Setting Parameters

Code	Parameter Name	Setting Range	Default	Unit	Control mode							Attribute
					V/F	V/F +PG	SLV	SV	PM SV	PM SLV	SLV2	
14-36	MD1 Set Value 1	0~65534 (Note4)	1	-	○	○	○	○	○	○	○	Note6
14-37	MD1 Set Value 2	0~65534 (Note4)	1	-	○	○	○	○	○	○	○	Note6
14-38	MD1 Set Value 3	0~65534 (Note4)	1	-	○	○	○	○	○	○	○	Note6
14-39	MD2 Set Value 1	0~65534 (Note4)	1	-	○	○	○	○	○	○	○	Note6
14-40	MD2 Set Value 2	0~65534 (Note4)	1	-	○	○	○	○	○	○	○	Note6
14-41	MD2 Set Value 3	0~65534 (Note4)	1	-	○	○	○	○	○	○	○	Note6
14-42	MD3 Set Value 1	0~65534 (Note4)	1	-	○	○	○	○	○	○	○	Note6
14-43	MD3 Set Value 2	0~65534 (Note4)	1	-	○	○	○	○	○	○	○	Note6
14-44	MD3 Set Value 3	0~65534 (Note4)	1	-	○	○	○	○	○	○	○	Note6
14-45	MD4 Set Value 1	0~65534 (Note4)	1	-	○	○	○	○	○	○	○	Note6
14-46	MD4 Set Value 2	0~65534 (Note4)	1	-	○	○	○	○	○	○	○	Note6
14-47	MD4 Set Value 3	0~65534 (Note4)	1	-	○	○	○	○	○	○	○	Note6

### Group 15: PLC Monitoring Parameters

Code	Parameter Name	Setting Range	Default	Unit	Control mode							Attribute
					V/F	V/F +PG	SLV	SV	PM SV	PM SLV	SLV2	
15-00	T1 Current Value1	0~9999	0	-	○	○	○	○	○	○	○	
15-01	T1 Current Value 2 (Mode7)	0~9999	0	-	○	○	○	○	○	○	○	
15-02	T2 Current Value 1	0~9999	0	-	○	○	○	○	○	○	○	
15-03	T2 Current Value 2 (Mode7)	0~9999	0	-	○	○	○	○	○	○	○	
15-04	T3 Current Value 1	0~9999	0	-	○	○	○	○	○	○	○	
15-05	T3 Current Value 2 (Mode7)	0~9999	0	-	○	○	○	○	○	○	○	
15-06	T4 Current Value 1	0~9999	0	-	○	○	○	○	○	○	○	
15-07	T4 Current Value 2 (Mode7)	0~9999	0	-	○	○	○	○	○	○	○	
15-08	T5 Current Value 1	0~9999	0	-	○	○	○	○	○	○	○	
15-09	T5 Current Value 2 (Mode7)	0~9999	0	-	○	○	○	○	○	○	○	
15-10	T6 Current Value 1	0~9999	0	-	○	○	○	○	○	○	○	
15-11	T6 Current Value 2 (Mode7)	0~9999	0	-	○	○	○	○	○	○	○	
15-12	T7 Current Value 1	0~9999	0	-	○	○	○	○	○	○	○	
15-13	T7 Current Value 2 (Mode7)	0~9999	0	-	○	○	○	○	○	○	○	
15-14	T8 Current Value 1	0~9999	0	-	○	○	○	○	○	○	○	
15-15	T8 Current Value 2 (Mode7)	0~9999	0	-	○	○	○	○	○	○	○	
15-16	C1 Current Value	0~65534 (Note4)	0	-	○	○	○	○	○	○	○	
15-17	C2 Current Value	0~65534 (Note4)	0	-	○	○	○	○	○	○	○	

Group 15: PLC Monitoring Parameters												
Code	Parameter Name	Setting Range	Default	Unit	Control mode							Attribute
					V/F	V/F+PG	SLV	SV	PM SV	PM SLV	SLV2	
15-18	C3 Current Value	0~65534 (Note4)	0	-	0	0	0	0	0	0	0	
15-19	C4 Current Value	0~65534 (Note4)	0	-	0	0	0	0	0	0	0	
15-20	C5 Current Value	0~65534 (Note4)	0	-	0	0	0	0	0	0	0	
15-21	C6 Current Value	0~65534 (Note4)	0	-	0	0	0	0	0	0	0	
15-22	C7 Current Value	0~65534 (Note4)	0	-	0	0	0	0	0	0	0	
15-23	C8 Current Value	0~65534 (Note4)	0	-	0	0	0	0	0	0	0	
15-24	AS1 Current Value	0~65534 (Note4)	0	-	0	0	0	0	0	0	0	
15-25	AS2 Current Value	0~65534 (Note4)	0	-	0	0	0	0	0	0	0	
15-26	AS3 Current Value	0~65534 (Note4)	0	-	0	0	0	0	0	0	0	
15-27	AS4 Current Value	0~65534 (Note4)	0	-	0	0	0	0	0	0	0	
15-28	MD1 Current Value	0~65534 (Note4)	0	-	0	0	0	0	0	0	0	
15-29	MD2 Current Value	0~65534 (Note4)	0	-	0	0	0	0	0	0	0	
15-30	MD3 Current Value	0~65534 (Note4)	0	-	0	0	0	0	0	0	0	
15-31	MD4 Current Value	0~65534 (Note4)	0	-	0	0	0	0	0	0	0	
15-32	TD Current Value	0~65534 (Note4)	0	-	0	0	0	0	0	0	0	

Group 16: LCD Function Parameters												
Code	Parameter Name	Setting Range	Default	Unit	Control mode							Attribute
					V/F	V/F+PG	SLV	SV	PM SV	PMS LV	SLV2	
16-00	Main Screen Monitoring	5~82 (Note4) when using LCD to operate, the monitored item displays in the first line. (default is frequency command)	16	-	0	0	0	0	0	0	0	*1
16-01	Sub-Screen Monitoring 1	5~82 (Note4) when using LCD to operate, the monitored item displays in the second line. (default is output frequency)	17	-	0	0	0	0	0	0	0	*1
16-02	Sub-Screen Monitoring 2	5~82 (Note4) when using LCD to operate, the monitored item displays in the third line. (default is output current)	18	-	0	0	0	0	0	0	0	*1

**Group 16: LCD Function Parameters**

Code	Parameter Name	Setting Range	Default	Unit	Control mode						Attribute	
					V/F	V/F+PG	SLV	SV	PM SV	PMS LV		SLV2
16-03	Display Unit	0~39999 Determine the display way and unit of frequency command 0: Frequency display unit is 0.01Hz 1: Frequency display unit is 0.01% 2: Frequency display unit is rpm. 3~39: Reserved 40~9999: Users specify the format, Input 0XXXX represents the display of XXXX at 100%. 10001~19999: Users specify the format; Input 1XXXX represents the display of XXX.X at 100%. 20001~29999: Users specify the format, Input 2XXXX represents the display of XX.XX at 100%. 30001~39999: Users specify the format, Input 3XXXX represents the display of X.XXX at 100%.	0	-	○	○	○	○	○	○	○	

**Group 16: LCD Function Parameters**

Code	Parameter Name	Setting Range	Default	Unit	Control mode							Attribute
					V/F	V/F+PG	SLV	SV	PM SV	PMS LV	SLV2	
16-04	Engineering Unit	0: without using engineering unit 1: FPM 2: CFM 3: PSI 4: GPH 5: GPM 6: IN 7: FT 8: /s 9: /m 10: /h 11: °F 12: inW 13: HP 14: m/s 15: MPM 16: CMM 17: W 18: KW 19: m 20: °C 21: RPM 22: Bar 23: Pa 24: KPa 25: PRS 26: SPM	0	-	0	0	0	0	0	0	0	
16-05	LCD Backlight	0~7	5	-	0	0	0	0	0	0	0	*1
16-06	Reserved											
16-07	Copy Function Selection	0: Do not copy parameters 1: Read inverter parameters and save to the operator. 2: Write the operator parameters to inverter. 3: Compare parameters of inverter and operator.	0	-	0	0	0	0	0	0	0	
16-08	Selection of Allowing Reading	0: Do not allow to read inverter parameters and save to the operator.	0	-	0	0	0	0	0	0	0	
		1: Allow to read inverter										

**Group 16: LCD Function Parameters**

Code	Parameter Name	Setting Range	Default	Unit	Control mode							Attribute
					V/F	V/F+PG	SLV	SV	PM SV	PMS LV	SLV2	
		parameters and save to the operator.										
16-09	Selection of Operator Removed (LCD)	0: Keep operating when LCD operator is removed. 1: Display fault when LCD operator is removed	0	-	○	○	○	○	○	○	○	*1
16-10	RTC Time Display Setting	0: Hide 1: Display	0		○	○	○	○	○	○	○	Note8
16-11	RTC Date Setting	12.01.01 ~ 99.12.31	12.01.01		○	○	○	○	○	○	○	Note8
16-12	RTC Time Setting	00:00 ~ 23:59	00:00		○	○	○	○	○	○	○	Note8
16-13	RTC Timer Function	0: Disable 1: Enable 2: Set by DI	0		○	○	○	○	○	○	○	Note8
16-14	P1 Start Time	00:00 ~ 23:59	08:00		○	○	○	○	○	○	○	Note8
16-15	P1 Stop Time	00:00 ~ 23:59	18:00		○	○	○	○	○	○	○	Note8
16-16	P1 Start Date	1:Mon 2:Tue 3:Wed 4:Thu 5:Fri 6:Sat 7:Sun	1		○	○	○	○	○	○	○	Note8
16-17	P1 Stop Date		5		○	○	○	○	○	○	○	Note8
16-18	P2 Start Time	00:00 ~ 23:59	08:00		○	○	○	○	○	○	○	Note8
16-19	P2 Stop Time	00:00 ~ 23:59	18:00		○	○	○	○	○	○	○	Note8
16-20	P2 Start Date	1:Mon 2:Tue 3:Wed 4:Thu 5:Fri 6:Sat 7:Sun	1		○	○	○	○	○	○	○	Note8
16-21	P2 Stop Date		5		○	○	○	○	○	○	○	Note8
16-22	P3 Start Time	00:00 ~ 23:59	08:00		○	○	○	○	○	○	○	Note8
16-23	P3 Stop Time	00:00 ~ 23:59	18:00		○	○	○	○	○	○	○	Note8
16-24	P3 Start Date	1:Mon 2:Tue 3:Wed 4:Thu 5:Fri 6:Sat 7:Sun	1		○	○	○	○	○	○	○	Note8
16-25	P3 Stop Date		5		○	○	○	○	○	○	○	Note8
16-26	P4 Start Time	00:00 ~ 23:59	08:00		○	○	○	○	○	○	○	Note8
16-27	P4 Stop Time	00:00 ~ 23:59	18:00		○	○	○	○	○	○	○	Note8

**Group 16: LCD Function Parameters**

Code	Parameter Name	Setting Range	Default	Unit	Control mode							Attribute
					V/F	V/F+PG	SLV	SV	PM SV	PMS LV	SLV2	
16-28	P4 Start Date	1:Mon 2:Tue 3:Wed 4:Thu	1		○	○	○	○	○	○	○	Note8
16-29	P4 Stop Date	5:Fri 6:Sat 7:Sun	5		○	○	○	○	○	○	○	Note8
16-30	Selection of RTC Offset	0: Disable 1: Enable 2: Set by DI	0		○	○	○	○	○	○	○	Note8
16-31	RTC Offset Time Setting	00:00 ~ 23:59	00:00	-	○	○	○	○	○	○	○	Note8
16-32	Source of Timer 1	0: None, 1:P1, 2:P2, 3:P1+P2 4:P3, 5:P1+P3, 6:P2+P3, 7:P1+P2+P3, 8:P4, 9:P1+P4, 10:P2+P4, 11:P1+P2+P4 12:P3+P4 13:P1+P3+P4, 14:P2+P3+P4 15:P1+P2+P3+P4, 16:Off, 17:Off+P1 18:Off+P2, 19:Off+P1+P2 20:Off+P3, 21:Off+P1+P3 22:Off+P2+P3 23:Off+P1+P2+P3 24:Off+P4 25:Off+P1+P4 26:Off+P2+P4 27:Off+P1+P2+P4 28:Off+P3+P4 29:Off+P1+P3+P4 30:Off+P2+P3+P4 31:Off+P1+P2+P3+P4	1		○	○	○	○	○	○	○	Note8
16-33	Source of Timer 2		2		○	○	○	○	○	○	○	Note8
16-34	Source of Timer 3		4		○	○	○	○	○	○	○	Note8
16-35	Source of Timer 4		8		○	○	○	○	○	○	○	Note8
16-36	Selection of RTC Speed	0: Off 1: By Timer 1 2: By Timer 2 3: By Timer 3 4: By Timer 4 5: By Timer 1+2	0		○	○	○	○	○	○	○	Note8

**Group 16: LCD Function Parameters**

Code	Parameter Name	Setting Range	Default	Unit	Control mode						Attribute	
					V/F	V/F+PG	SLV	SV	PM SV	PMS LV		SLV2
16-37	Selection of RTC Rotation Direction	xxx0b: RTC Run1 Forward Rotation xxx1b: RTC Run1 Reverse Rotation xx0xb: RTC Run2 Forward Rotation xx1xb: RTC Run2 Reverse Rotation x0xxb: RTC Run3 Forward Rotation x1xxb: RTC Run3 Reverse Rotation 0xxxb: RTC Run4 Forward Rotation 1xxxb: RTC Run4 Reverse Rotation	0000b		0	0	0	0	0	0	0	Note8

Group 17: Automatic Tuning Parameters													
Code	Parameter Name	Setting Range	Default	Unit	Control mode							Attribute	
					V/F	V/F+PG	SLV	SV	PM SV	PMS LV	SLV2		
17-00	Mode Selection of Automatic Tuning*	0: Rotation Auto-tuning 1: Static Auto-tuning 2: Stator Resistance Measurement 3: Reserved 4: Loop Tuning 5: Rotation Auto-tuning Combination (item: 4+2+0) 6: Static Auto-tuning Combination (item: 4+2+1)	VF:2 VF+PG :2 SLV:6 SV:6 SLV2:6	-		O	O	O	O	X	X	O	
17-01	Motor Rated Output Power	0.00~600.00	KVA	KW	O	O	O	O	X	X	O		
17-02	Motor Rated Current	0.1~1200.0	KVA	A	O	O	O	O	X	X	O		
17-03	Motor Rated Voltage	200V: 50.0~240.0 400V: 100.0~480.0 575V:150.0~670.0 690V: 180.0~804.0	-	V	O	O	O	O	X	X	O		
17-04	Motor Rated Frequency	4.8~599.0	50.0/ 60.0	Hz	O	O	O	O	X	X	O		
17-05	Motor Rated Speed	0~24000	KVA	rpm	O	O	O	O	X	X	O		
17-06	Pole Number of Motor	2~16 (Even)	4	Pole	O	O	O	O	X	X	O		
17-07	PG Pulse Number	0~60000	1024	ppr	X	O	X	O	X	X	X		
17-08	Motor no-load Voltage	200V: 50~240 400V: 100~480 575V: 420~600 690V: 504~720	-	V	O	O	O	O	X	X	O		
17-09	Motor Excitation Current	0.01~600.00	-	A	X	X	O	O	X	X	X	■1	
17-10	Automatic Tuning Start	0: Disable 1: Enable	0	-	O	O	O	O	X	X	O		
17-11	Error History of Automatic Tuning	0: No error 1: Motor data error 2: Stator resistance tuning error 3: Leakage induction tuning error 4: Rotor resistance tuning error 5: Mutual induction tuning error 6: Encoder error 7: DT Error 8: Motor's acceleration error 9: Warning	0	-	O	O	O	O	X	X	O		



Group 17: Automatic Tuning Parameters												
Code	Parameter Name	Setting Range	Default	Unit	Control mode							Attribute
					V/F	V/F+PG	SLV	SV	PM SV	PMS LV	SLV2	
17-12	Proportion of Motor Leakage Inductance	0.1~15.0	3.4	%	X	X	O	O	X	X	X	
17-13	Motor Slip Frequency	0.10~20.00	1.00	Hz	X	X	O	O	X	X	X	
17-14	Selection of Rotation Auto-tuning	0:VF Rotation Auto-tuning 1: Vector Rotation Auto-tuning	0	-	O	O	O	O	X	X	O	

**KVA:** The default value of this parameter will be changed by different capacities of inverter.

\*: The default value is 1 in VF/ VF+PG mode while the default value is 0 in SLV/ SV/ SLV2 mode.

\*: It is suggested that HD/ ND mode (00-27) and application presets (00-32) be selected first before motor performs auto-tuning.

**Note:** The value of mode selection of automatic tuning is 6 (Static Auto-tuning Combination). When do auto-tuning with no-load motor, it suggest select 17-00=5 (Rotation Auto-tuning Combination)

■1: It can be set when 17-00=1, 2, 6.

Group 18: Slip Compensation Parameters												
Code	Parameter Name	Setting Range	Default	Unit	Control mode							Attribute
					V/F	V/F+PG	SLV	SV	PM SV	PMS LV	SLV2	
18-00	Slip Compensation Gain at Low Speed.	0.00~2.50	VF:0.0	-	O	X	O	O	X	X	O	*1
			0									
			SLV*									
18-01	Slip Compensation Gain at High Speed.	-1.00~1.00	0.0	-	O	X	O	X	X	X	X	*1
18-02	Slip Compensation Limit	0~250	200	%	O	X	X	X	X	X	X	
18-03	Slip Compensation Filter Time	0.0~10.0	1.0	Sec	O	X	X	X	X	X	X	
18-04	Regenerative Slip Compensation Selection	0: Disable 1: Enable	0	-	O	X	X	X	X	X	X	
18-05	FOC Delay Time	1~1000	100	ms	X	X	O	X	X	X	X	
18-06	FOC Gain	0.00~2.00	0.1	-	X	X	O	X	X	X	X	

\*: Refer to the following attachment 1.

Group 19: Wobble Frequency Parameters												
Code	Parameter Name	Setting Range	Default	Unit	Control mode							Attribute
					V/F	V/F+PG	SLV	SV	PM SV	PMS LV	SLV2	
19-00	Center Frequency of Wobble Frequency	5.00~100.00	20.00	%	O	O	X	X	X	X	O	*1
19-01	Amplitude of Wobble Frequency	0.1~20.0	10.0	%	O	O	X	X	X	X	O	*1
19-02	Jump Frequency of Wobble Frequency	0.0~50.0	0.0	%	O	O	X	X	X	X	O	*1
19-03	Jump Time of Wobble Frequency	0~50	0	ms	O	O	X	X	X	X	O	*1
19-04	Wobble Frequency Cycle	0.0~1000.0	10.0	Sec	O	O	X	X	X	X	O	*1
19-05	Wobble Frequency Ratio	0.1~10.0	1.0		O	O	X	X	X	X	O	*1
19-06	Upper Offset Amplitude of Wobble Frequency	0.0~20.0	0.0	%	O	O	X	X	X	X	O	*1
19-07	Lower Offset Amplitude of Wobble Frequency	0.0~20.0	0.0	%	O	O	X	X	X	X	O	*1

**Group 20: Speed Control Parameters**

Code	Parameter Name	Setting Range	Default	Unit	Control mode							Attribute	
					V/F	V/F+P G	SLV	SV	PM SV	PMS LV	SLV2		
20-00	ASR Gain 1	0.00~250.00	-	-	X	O	O	O	O	O	O	X	*1
20-01	ASR Integral Time 1	0.001~10.000	-	Sec	X	O	O	O	O	O	O	X	*1
20-02	ASR Gain 2	0.00~250.00	-	-	X	O	O	O	O	O	O	X	*1
20-03	ASR Integral Time 2	0.001~10.000	-	Sec	X	O	O	O	O	O	O	X	*1
20-04	ASR Integral Time Limit	0~300	200	%	X	X	O	O	O	O	O	X	
20-05	ASR Positive Limit	0.1 ~ 10.0	5.0	%	X	O	X	X	X	X	X	X	
20-06	ASR Negative Limit	0.1 ~ 10.0	1.0	%	X	O	X	X	X	X	X	X	
20-07	Selection of Acceleration and Deceleration of P/PI	0: PI speed control will be enabled only in constant speed. For the speed acceleration and deceleration, only use P control. 1: Speed control is enabled either in acceleration or deceleration.	0	-	X	O	O	O	O	O	X	X	
20-08	ASR Delay Time	0.000~0.500	0.004	Sec	O	X	O	O	O	O	O	X	Note5
20-09	Speed Observer Proportional (P) Gain1	0.00~2.55	0.61	-	X	X	O	X	X	X	X	X	*1
20-10	Speed Observer Integral(I) Time 1	0.01~10.00	0.05	Sec	X	X	O	X	X	X	X	X	*1
20-11	Speed Observer Proportional (P) Gain2	0.00~2.55	0.61	-	X	X	O	X	X	X	X	X	*1
20-12	Speed Observer Integral(I) Time 2	0.01~10.00	0.06	Sec	X	X	O	X	X	X	X	X	*1
20-13	Low-pass Filter Time Constant of Speed Feedback 1	1~1000	4	ms	X	X	O	X	X	X	X	X	
20-14	Low-pass Filter Time Constant of Speed Feedback 2	1~1000	30	ms	X	X	O	X	X	X	X	X	
20-15	ASR Gain Change Frequency 1	0.0~599.0	4.0	Hz	X	O	O	O	O	O	X	O	
20-16	ASR Gain Change Frequency 2	0.0~599.0	8.0	Hz	X	X	O	O	O	O	X	O	
20-17	Torque Compensation Gain at Low Speed	0.00~2.50	1.00	-	X	X	O	X	X	X	X	X	*1
20-18	Torque Compensation Gain at High Speed	-10~10	0	%	X	X	O	X	X	X	X	X	*1

**Group 20: Speed Control Parameters**

Code	Parameter Name	Setting Range	Default	Unit	Control mode							Attribute
					V/F	V/F+P G	SLV	SV	PM SV	PMS LV	SLV2	
20-19	Over Speed (OS) Selection	0: Deceleration to stop 1: Coast to stop 2: Continue to operate	1		X	O	X	O	O	X	X	
20-20	Over Speed (OS) Detection Level	0~120	115	%	X	O	X	O	O	X	X	
20-21	Over Speed (OS) Detection Time	0.0~2.0	0.5	Sec	X	O	X	O	O	X	X	
20-22	Speed Deviation (DEV) Selection	0: Deceleration to Stop 1: Coast to Stop 2: Continue to Operate	2		X	O	X	O	O	X	X	
20-23	Speed Deviation (DEV) Detection Level	0~50	10	%	X	O	X	O	O	X	X	
20-24	Speed Deviation (DEV) Detection Time	0.0~10.0	0.5	Sec	X	O	X	O	O	X	X	
20-25	Selection of PG Open	0: Deceleration to Stop 1: Coast to Stop 2: Continue to Operate	1	-	X	O	X	O	O	X	X	
20-26	Detection Time of PG Open	0.0~10.0	2.0	Sec	X	O	X	O	O	X	X	
20-27	PG Pulse Number	0~9999	1024	ppr	O	O	X	O	O	X	X	Note5
20-28	Selection of PG Rotation Direction	0: Forward as Counter -Clockwise Rotation 1: Forward as Clockwise Rotation	0	-	O	O	X	O	O	X	X	Note5
20-29	PG Pulse Dividing Ratio	001~132	1	-	X	O	X	O	O	X	X	
20-30	PG Gear Ratio 1	1~1000	1	-	X	O	X	O	X	X	X	
20-31	PG Gear Ratio 2	1~1000	1	-	X	O	X	O	X	X	X	
20-32	Selection of Specific Encoder	0: None 1: Resolver	0		X	X	X	O	O	X	X	
20-33	Detection Level at Constant Speed	0.1~5.0	1.0		X	O	O	O	O	O	X	*1
20-34	Compensation Gain of Derating	0~25600	0		X	X	O	O	O	X	X	*1
20-35	Compensation Time of Derating	0~30000	100	ms	X	X	O	O	O	X	X	*1
20-36~ 20-42	Reserved											
20-43	MPG Speed Magnification Calculation	1~500	20		O	O	X	O	X	X	X	Note5
20-44	MPG Speed Command Limit	0.1~30.0	6.0	Hz	O	X	X	X	X	X	X	Note5

**Group 21: Torque And Position Control Parameters**

Code	Parameter Name	Setting Range	Default	Unit	Control mode							Attribute
					V/F	V/F+P G	SLV	SV	PM SV	PMS LV	SLV2	
21-00	Torque Control Selection	0: Speed Control 1: Torque Control	0	-	X	X	X	O	O	X	X	
21-01	Filter Time of Torque Reference	0~1000	0	ms	X	X	X	O	O	X	X	
21-02	Speed Limit Selection	0: According to AI Input 1: According to the Set Value of 21-03 2: According to communication position input (2502H)	0	-	X	X	X	O	O	X	X	
21-03	Speed Limit Value	-120~120	0	%	X	X	X	O	O	X	X	*1
21-04	Speed Limit Bias	0~120	10	%	X	X	X	O	O	X	X	*1
21-05	Positive Torque Limit	0~300	*	%	X	X	O	O	O	O	X	
21-06	Negative Torque Limit	0~300	*	%	X	X	O	O	O	O	X	
21-07	Forward Regenerative Torque Limit	0~300	*	%	X	X	O	O	O	O	X	
21-08	Reversal Regenerative Torque Limit	0~300	*	%	X	X	O	O	O	O	X	
21-09	Maximum Frequency of Position Control	0.1~100.0	20.0	Hz	X	X	X	O	O	X	X	
21-10	The Command of Rotation Cycle Number of Section 0	-9999 ~ 9999	0	-	X	X	X	O	O	X	X	
21-11	The Command of the Pulse Number of Section 0	-9999 ~ 9999	0	-	X	X	X	O	O	X	X	
21-12	The Command of Rotation Cycle Number of Section 1	-9999 ~ 9999	0	-	X	X	X	O	O	X	X	
21-13	The Command of the Pulse Number of Section 1	-9999 ~ 9999	0	-	X	X	X	O	O	X	X	
21-14	The Command of Rotation Cycle Number of Section 2	-9999 ~ 9999	0	-	X	X	X	O	O	X	X	
21-15	The Command of the Pulse Number of Section 2	-9999 ~ 9999	0	-	X	X	X	O	O	X	X	
21-16	The Command of Rotation Cycle Number of Section	-9999 ~ 9999	0	-	X	X	X	O	O	X	X	

**Group 21: Torque And Position Control Parameters**

Code	Parameter Name	Setting Range	Default	Unit	Control mode						Attribute	
					V/F	V/F+P G	SLV	SV	PM SV	PMS LV		SLV2
	3											
21-17	The Command of the Pulse Number of Section 3	-9999 ~ 9999	0	-	X	X	X	O	O	X	X	
21-18	The Command of Rotation Cycle Number of Section 4	-9999 ~ 9999	0	-	X	X	X	O	O	X	X	
21-19	The Command of the Pulse Number of Section 4	-9999 ~ 9999	0	-	X	X	X	O	O	X	X	
21-20	The Command of Rotation Cycle Number of Section 5	-9999 ~ 9999	0	-	X	X	X	O	O	X	X	
21-21	The Command of the Pulse Number of Section 5	-9999 ~ 9999	0	-	X	X	X	O	O	X	X	
21-22	The Command of Rotation Cycle Number of Section 6	-9999 ~ 9999	0	-	X	X	X	O	O	X	X	
21-23	The Command of the Pulse Number of Section 6	-9999 ~ 9999	0	-	X	X	X	O	O	X	X	
21-24	The Command of Rotation Cycle Number of Section 7	-9999 ~ 9999	0	-	X	X	X	O	O	X	X	
21-25	The Command of the Pulse Number of Section 7	-9999 ~ 9999	0	-	X	X	X	O	O	X	X	
21-26	The Command of the Pulse Number of Section 8	-9999 ~ 9999	0	-	X	X	X	O	O	X	X	
21-27	The Command of Rotation Cycle Number of Section 8	-9999 ~ 9999	0	-	X	X	X	O	O	X	X	
21-28	The Command of the Pulse Number of Section 9	-9999 ~ 9999	0	-	X	X	X	O	O	X	X	
21-29	The Command of Rotation Cycle Number of Section 9	-9999 ~ 9999	0	-	X	X	X	O	O	X	X	
21-30	The Command of Rotation Cycle Number of Section 10	-9999 ~ 9999	0	-	X	X	X	O	O	X	X	
21-31	The Command of the Pulse Number	-9999 ~ 9999	0	-	X	X	X	O	O	X	X	

**Group 21: Torque And Position Control Parameters**

Code	Parameter Name	Setting Range	Default	Unit	Control mode							Attribute
					V/F	V/F+P G	SLV	SV	PM SV	PMS LV	SLV2	
	of Section 10											
21-32	The Command of Rotation Cycle Number of Section 11	-9999 ~ 9999	0	-	X	X	X	O	O	X	X	
21-33	The Command of the Pulse Number of Section 11	-9999 ~ 9999	0	-	X	X	X	O	O	X	X	
21-34	The Command of Rotation Cycle Number of Section 12	-9999 ~ 9999	0	-	X	X	X	O	O	X	X	
21-35	The Command of the Pulse Number of Section 12	-9999 ~ 9999	0	-	X	X	X	O	O	X	X	
21-36	The Command of Rotation Cycle Number of Section 13	-9999 ~ 9999	0	-	X	X	X	O	O	X	X	
21-37	The Command of the Pulse Number of Section 13	-9999 ~ 9999	0	-	X	X	X	O	O	X	X	
21-38	The Command of Rotation Cycle Number of Section 14	-9999 ~ 9999	0	-	X	X	X	O	O	X	X	
21-39	The Command of the Pulse Number of Section 14	-9999 ~ 9999	0	-	X	X	X	O	O	X	X	
21-40	The Command of Rotation Cycle Number of Section 15	-9999 ~ 9999	0	-	X	X	X	O	O	X	X	
21-41	The Command of the Pulse Number of Section 15	-9999 ~ 9999	0	-	X	X	X	O	O	X	X	
21-42	Pos. Mode Selection	0: Switch to position mode when output frequency < 01-08. 1: Z Phase Locked Function	0		X	X	X	O	O	X	X	
21-43	Offset Angle	0 ~9999	0	Pulse	X	X	X	O	O	X	X	

\* Refer to the following attachment 1.

**Group 22: PM Motor Parameters**

Code	Parameter Name	Setting Range	Default	Unit	Control mode							Attribute
					V/F	V/F+P G	SLV	SV	PMS V	PM SLV	SLV2	
22-00	PM Motor Rated Power	0.00~600.00	KVA	kW	X	X	X	X	O	O	X	
22-01	PM Motor Rated Voltage	200V: 50.0~240.0 400V: 100.0~480.0	220.0 440.0	V	X	X	X	X	O	O	X	Note7
22-02	PM Motor Rated Current	25%~200% inverter's rated current	KVA	A	X	X	X	X	O	O	X	
22-03	PM Motor's Pole Number	2~96	6	poles	X	X	X	X	O	O	X	
22-04	PM Motor's Rotation Speed	6~60000	1500	rpm	X	X	X	X	O	O	X	
22-05	PM Motor's Maximum Rotation Speed	6~60000	1500	rpm	X	X	X	X	O	O	X	
22-06	PM Motor Rated Frequency	4.8~599.0	75.0	Hz	X	X	X	X	O	O	X	
22-07	PM Type Selection	0:SPM 1:IPM	0		X	X	X	X	X	O	X	Note7
22-08	PM Encoder Type	0: TAMAGAWA Non Wire-Saving Encoder 1: TAMAGAWA Wire-Saving Encoder 2: SUMTAK Wire-Saving Encoder 3: General Incremental Encoder 4: Sine Wave	0		X	X	X	X	O	X	X	
22-09	Reserved											
22-10	PM SLV Start Current	20% ~ 200% Motor Rated Current	80	%	X	X	X	X	X	O	X	
22-11	I/F Mode Start Frequency Switching Point	10 ~ 100 (Note 7)	10	%	X	X	X	X	X	O	X	
22-12 22-13	Reserved (Note4)											
22-14	Armature Resistance of PM Motor	0.001 ~ 30.000	1.000	Ω	X	X	X	X	O	O	X	
22-15	D-axis Inductance of PM Motor	0.01 ~ 300.00	10.00	mH	X	X	X	X	O	O	X	
22-16	Q-axis Inductance of PM Motor	0.01 ~ 300.00	10.00	mH	X	X	X	X	O	O	X	
22-17	PM No-Load Voltage	200V: 0~250 400V: 0~500	150 300	V	X	X	X	X	O	O	X	Note7
22-18	Flux-Weakening Limit	0~120	90	%	X	X	X	X	O	O	X	



Group 22: PM Motor Parameters												
Code	Parameter Name	Setting Range	Default	Unit	Control mode							Attribute
					V/F	V/F+P G	SLV	SV	PMS V	PM SLV	SLV2	
22-19	Reserved											
22-20	Offset Angle of the Magnetic Pole and PG Origin	0~360	0	deg	X	X	X	X	O	X	X	*4
22-21	PM Motor Tuning	0: PM Motor Tuning is not Active. 1: Parameter Auto-tuning (for PMSLV Tuning) 2: Magnetic Pole Alignment and Loop Adjustment (for PMSV Tuning) 3: Rotation Auto-tuning	0	-	X	X	X	X	O	O	X	
22-22	Fault History of PM Motor Tuning	0. No Error 1. Static Magnetic Alignment Fault 2. Without PG Option Card 3. Rotation Pole Alignment is Forced to Stop 4. Error of Encoder Feedback Direction 5. Loop Adjustment is Time out 6. Encoder Error 7. Other Errors of Motor Tuning 8. Current Abnormity Occurs when Aligning Rotation Magnetic Pole. 9. Current Abnormity Occurs while Loop Adjustment. 10.Reserved 11. Stator Resistance Measurement Timeout	0	-	X	X	X	X	O	O	X	*4
22-23 22-24	Reserved											
22-25	Detection Mode Selection of Initial Magnetic Pole	0: Upon the angle before stopping 1: Mode 1 2: Mode 2 3: Mode 3	2 (Note7)	-	X	X	X	X	O	O	X	
22-26	High speed control ratio enable (For PMSLV)	0: Low Speed Open Loop Control 1: Low Speed High Frequency Estimate Control	0	-	X	X	X	X	X	O	X	

Group 22: PM Motor Parameters												
Code	Parameter Name	Setting Range	Default	Unit	Control mode						Attribute	
					V/F	V/F+P G	SLV	SV	PMS V	PM SLV		SLV2
		2: Full Closed Loop Control										
22-27	Voltage Command of Mode 2	5~120 (Note 7) (22-25=2 or 22-26=1 is enabled)	50	%	X	X	X	X	O	O	X	
22-28	Divider Ratio of Mode 2	0~8 (Note 7) (22-25=2 or 22-26=1 is enabled)	2	-	X	X	X	X	O	O	X	
22-29	Flux-weakening Voltage Command Restriction	80~110 (Note 7) (related to parameter 22-18)	100	%	X	X	X	X	O	O	X	
22-30	SPM Speed Estimation Gain (Note7)	1~150	85	%	X	X	X	X	X	O	X	Note4
22-31	SPM Speed Estimation Filter Value (Note7)	1~2000	60	Hz	X	X	X	X	X	O	X	Note4
22-32	MTPA Selection	0: Disabled 1: Mode 1	0	-	X	X	X	X	O	O	X	Note7
22-33	MTPA Gain	0~400%	200	%	X	X	X	X	O	O	X	Note7
22-34	IPM Estimator Gain	1~300.0	180	-	X	X	X	X	X	O	X	Note7
22-35	Reserved											
22-36	PM Motor Type Selection	0: Normal PM motor 1: DVEN Motor	0	-	X	X	X	X	X	O	X	Note 8
22-37	PM Motor Horse Power & RPM	1: 0.75KW 1800RPM 4: 1.5KW 1800RPM 7: 2.2KW 1800RPM 10: 3.7KW 1800RPM 13: 5.5KW 1800RPM 16: 7.5KW 1800RPM 19: 11KW 1800RPM 22: 15KW 1800RPM 25: 18.5KW 1800RPM 28: 22KW 1800RPM	0	-	X	X	X	X	X	O	X	Note 8
22-38	Open and closed loop switching point frequency width (%)	1.0~40.0	5.0	%	X	X	X	X	X	O	X	
22-39	Preliminary DC injection time	0~20.00	0.10	Sec	X	X	X	X	X	O	X	
22-40	High frequency angle finding time	0.01~1.00	0.01	-	X	X	X	X	X	O	X	

### Group 22: PM Motor Parameters

Code	Parameter Name	Setting Range	Default	Unit	Control mode							Attribute
					V/F	V/F+P G	SLV	SV	PMS V	PM SLV	SLV2	
22-41	PM stop method	0: Decelerate or stop below 22-11 and brake directly 1: Decelerate or stop below 22-11 and open loop stop	0	-	X	X	X	X	X	O	X	
22-42	Fully closed loop control gain Ka	64~8192	100	-	X	X	X	X	X	O	X	
22-43	Fully closed loop control gain Kb	64~8192	2000	-	X	X	X	X	X	O	X	
22-44	Fully closed loop control gain speed low pass filter	1~256	4	-	X	X	X	X	X	O	X	
22-45	Fully closed loop control magnetic flux	0.01~10.00	0.70	-	X	X	X	X	X	O	X	

**Attachment 1: Parameters' default value and upper limit value are adjusted by different capacities of inverter.**

Models	Frame	Max. frequency (Hz) in SLV when carrier frequency <= 8K 11-01	Max. frequency (Hz) in SLV when carrier frequency > 8K 11-01	Display parameter 12-41 (Inverter temperature)	The initial value of parameter 18-00 in SLV/ SV (Slip compensation at low speed)
2001	1	150	150	Yes	1.00
2002					
2003	2	150	150	Yes	1.00
2005					
2008					
2010	3	150	150	Yes	1.00
2015	4	110	110	Yes	1.00
2020					
2025					
2030	5	100	80	Yes	0.70
2040					
2050	6	100	80	No	0.70
2060					
2075	7	100	95	No	0.50
2100					
2125					
2150	8	100	80	No	0.50
4001	1	150	150	Yes	1.00
4002					
4003					
4005	2	150	150	Yes	1.00
4008					
4010	3	150	150	Yes	1.00
4015					
4020	4	110	110	Yes	1.00
4025		100	100		
4030		100	100		
4040	5	100	80	Yes	0.70
4050					
4060					
4075					
4100	6	100	80	No	0.70
4125					
4150	7	100	80	No	0.50
4175					
4215					
4215H(Note)	8	100	80	No	0.50
4270					
4300					
4375					
4425					

Models	The initial value of parameters 21-05 ~21-08 (Torque Limit)	The initial value (s) of parameter 20-08 (ASR Filter Time)	The initial value (V) of parameter 08-02(Stall Level in Deceleration)	The initial value (s) of Accel. & Decel 00-14~00-17 & 00-23~00-27	Default carrier in HD kHz 11-01	Max. carrier in HD kHz (SLV, Max. > 80Hz) 11-01	Max. carrier in HD kHz (others) 11-01
2001	200%	0.001	385	10.0	8	8	16
2002					8	8	16
2003	200%	0.001	385	10.0	8	8	16
2005					8	8	16
2008	200%	0.001	385	10.0	8	8	16
2010					8	8	16
2015	200%	0.002	385	15.0	8	8	16
2020					8	8	16
2025					6	8	12
2030	160%	0.002	385	20.0	5	8	12
2040					5	8	12
2050	160%	0.004	385	20.0	5	8	10
2060					5	8	10
2075	160%	0.004	385	20.0	5	8	10
2100					5	8	10
2125	160%	0.004	385	20.0	5	8	5
2150					5	8	5
4001	200%	0.001	770	10.0	8	8	16
4002					8	8	16
4003					8	8	16
4005	200%	0.001	770	10.0	8	8	16
4008					8	8	16
4010	200%	0.001	770	10.0	8	8	16
4015					8	8	16
4020	200%	0.002	770	15.0	8	8	16
4025					8	8	16
4030					8	8	16
4040	160%	0.002	770	20.0	5	8	12
4050					5	8	12
4060					5	8	10
4075	160%	0.004	770	20.0	5	8	10
4100					5	8	10
4125	160%	0.004	770	20.0	4	8	10
4150					5	8	10
4175					5	8	10
4215					3	8	8
4215H(Note)	160%	0.004	770	20.0	4	5	5
4270							
4300							
4375							
4425					2		

Note: The spec. please refer to Chapter 3.18, the rated current is 330/370A.

**575/690V Models**

Model	Frame	Max. frequency (Hz) in SLV when carrier frequency <= 8K	Max. frequency (Hz) in SLV when carrier frequency > 8K	Display parameter 12-41 (Inverter temperature)	The initial value of parameter 18-00 in SLV/ SV (Slip compensation at low speed)
5001	2	150	150	Yes	1.00
5002					
5003					
5005	3	150	150	Yes	1.00
5008					
5010					
6015	4	110	110	Yes	1.00
6020					
6025					
6030					
6040					
6050	5	100	80	Yes	0.7
6060					
6075					
6100	6	100	80	NO	0.7
6125					
6150					
6175	7	100	80	NO	0.5
6215					
6250					
6270					

Models	The initial value of parameters 21-05 ~21-08 (Torque Limit)	The initial value (s) of parameter 20-08 (ASR Filter Time)	The initial value (s) of Accel. & Decel	Default carrier in HD kHz	Max. carrier in HD kHz (others)
5001	200%	0.002	10	8	16
5002				8	16
5003				8	16
5005	200%	0.002	20	8	16
5008				8	16
5010				8	16
6015	160%	0.004	25	4	8
6020				4	8
6025				4	8
6030				4	8
6040				4	8
6050	160%	0.004	30	4	8
6060				4	8
6075				4	8
6100	160%	0.004	30	3	6
6125				3	6
6150				3	6
6175	160%	0.004	30	2	4
6215				2	4
6250				2	4
6270				2	4

## Low Voltage Detection Level Function:

Wiring:

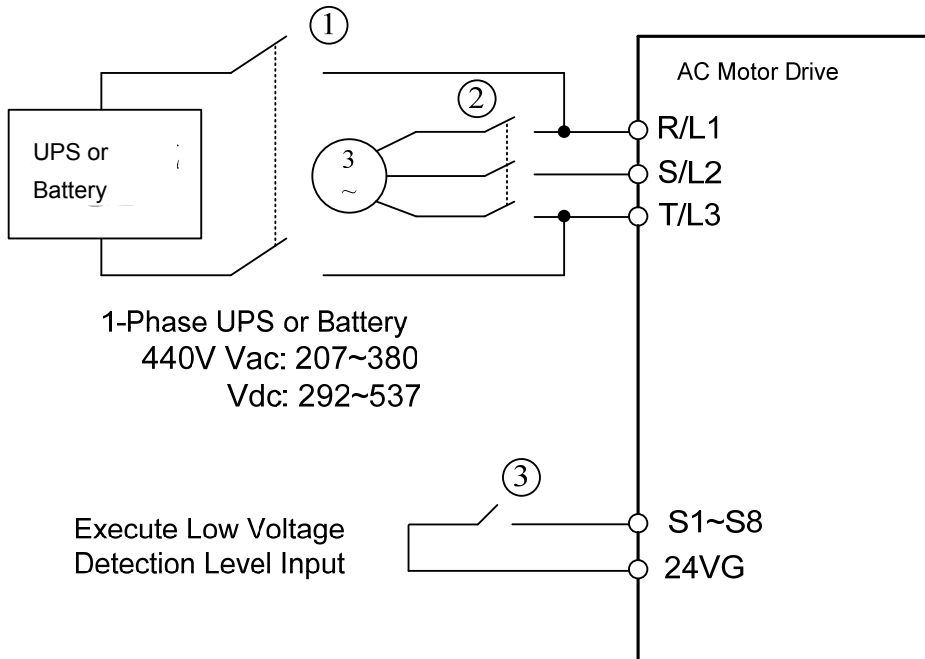

Timing Diagram of Magnetic Contactor

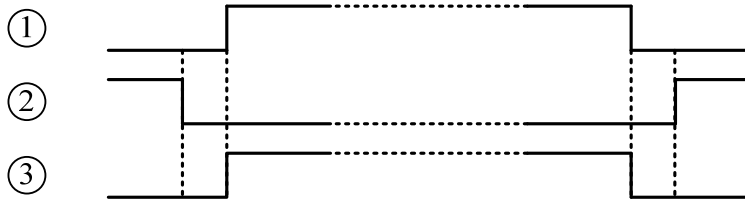

Before inputting emergency power, magnetic contactor ① and ③ are ON and magnetic contactor ② should be OFF. Magnetic contactor ③ should be ON after magnetic contactor ② is ON. Before removing battery and turning magnetic contactor ② to be ON, Magnetic contactor ① and ③ should be OFF.

Notes for the emergency power supply. Please be aware of the following condition when emergency power is ON:

1. Execute Low Voltage Function ON (DI=62) › Fan doesn't run.
2. Execute Low Voltage Function ON (DI=62) › No phase loss.
3. Execute Low Voltage Function ON (DI=62) › run frequency of motor depends on the value of 07-31

Relevant parameters:

- 07-30 Low Voltage Level Selection set 0 (Enable)
- 07-13 Low Voltage Detection Level set to 250V in 400V Class.
- 03-00~03-07 Set EPS input (62) enable.
- 07-31 Set Low Voltage Run Frequency



## 4.4 Description of Parameters

00-00	Control mode selection
Range	<b>0:</b> V/F <b>1:</b> V/F+PG <b>2:</b> SLV <b>3:</b> SV <b>4:</b> PMSV <b>5:</b> PMSLV <b>6:</b> SLV2

The inverter offers the following control modes:

Value	Mode	Info	Application
0	V/F	V/F Control without PG	General Purpose Applications which do not require high precision speed control - Auto-tuning is not required.
1	V/F+PG	V/F Control with PG (speed compensation)	Closed loop speed control for General purpose applications that require better speed control than V/F mode without PG.
2	SLV	Sensorless Vector Control without PG	General Purpose Applications that require higher precision speed control and torque response without the use of an encoder.
3	SV	Closed Loop Vector Control with PG	General Purpose Applications that require high precision speed control and torque response with the use of an encoder.
4	PMSV	PM Vector Control with PG (Permanent Magnet Vector Control)	PM Motor Applications that require high precision speed control and torque response with the use of an encoder.
5	PMSLV	Sensorless Current Vector Control without PG (for Permanent magnet motor) °	Without PG Applications. Provide the requirements of high precision speed and torque
6	SLV2	Voltage vector control without PG	Without PG Applications. Vector control provides high speed rotation and the requirements of higher precision speed than V/F and torque.

### 00-00=0: V/F Mode

Select the required V/F curve (01-00) based on your motor and applications.

Perform a stationary auto-tune (17-00=2), if the motor cable is longer than 50m (165ft), see parameter 17-00 for details.

### 00-00=1: V/F with PG

Select the required V/F curve (01-00) based on your motor and applications. Set number of motor poles (02-08) and encoder feedback pulses (20-27); refer to parameter group 20 for PF feedback setup. Perform a stationary auto-tune (17-00=2) if the distance between the inverter and the motor more than 50m (165ft), refer to parameter group 17 for details on auto-tuning.

**00-00=2: Sensorless Vector Control**

Verify the inverter rating matches the motor rating. Perform rotational auto-tune to measure and store motor parameters for higher performance operation. Perform non-rotational auto-tune if it's not possible to rotate the motor during auto-tune. Refer to parameter group 17 for details on auto-tuning.

**00-00=3: Closed Loop Vector Control**

Verify the inverter rating matches the motor rating. Perform rotational auto-tune to measure and store motor parameters for higher performance operation. Perform non-rotational auto-tune if it's not possible to rotate the motor during auto-tune. Refer to parameter group 17 for details on auto-tuning.

**00-00=4: PM Vector Control**

Verify the inverter rating matches the motor rating. Set PM motor data in parameters 22-00 to 22-06 and encoder feedback pulses in parameter 20-27. Refer to parameter 22-21 for details on PM Motor tuning.

Select the appropriate motor rating and braking resistor based on your motor and applications. Please install the braking module in the models of 200V 30HP/ 400V 40HP/575V/690V 50HP or the above.

**00-00=5: PM Sensorless Vector Control**

Verify the inverter rating matches the motor rating. Perform rotational auto-tune to measure and store motor parameters for higher performance operation.

Perform auto-tuning before operation to enhance the performance of PMSLV mode. Refer to parameter 22-21 for the descriptions of PM motor tuning function.

Select the appropriate motor rating and braking resistor based on your motor and applications. Please install the braking module in the models of 200V 30HP/ 400V 40HP/575V/690V 50HP or the above.

**00-00=6: SLV2 Vector Control**

Verify the inverter rating matches the motor rating. Perform rotational auto-tune to measure and store motor parameters for higher performance operation.

Refer to parameter group 17 for the descriptions of motor parameter tuning function.

Select the required V/F curve (01-00) based on your motor and applications.

**Note:** Parameter 00-00 is excluded from initialization.

<b>00-01</b>	<b>Motor's rotation direction</b>
<b>Range</b>	<b>0:</b> Forward <b>1:</b> Reverse

Use the FWD/REV key to change motor direction when Run Command Selection (00-02 = 0) is set to keypad control. In keypad control operation the direction is stored in 00-01. Direction of this function will be limited to the motor direction lock selection of parameter 11-00.

<b>00-02</b>	<b>Run command selection</b>
<b>Range</b>	<b>0:</b> Keypad control <b>1:</b> External terminal control <b>2:</b> Communication control <b>3:</b> PLC <b>4:</b> RTC

**00-02=0: Keypad Control**

Use the keypad to start and stop the inverter and set direction with the forward / reverse key). Refer to section 4-1 for details on the keypad.

**00-02=1: External terminal control**

External terminals are used to start and stop the inverter and select motor direction.

00- 03	Alternative RUN Command Selection
Range	<b>0:</b> Keypad control <b>1:</b> External terminal control <b>2:</b> Communication control <b>3:</b> PLC <b>4:</b> RTC

**00-03=0: Keypad Control**

Use the keypad to start and stop the inverter and set direction with the forward / reverse key). Refer to section 4-1 for details on the keypad.

**00-03=1: External terminal control**

External terminals are used to start and stop the inverter and select motor direction.

**\*It is required to be with multi-function digital input (12: main and alternative run switch function).**

The inverter can be operated in either 2-wire or 3-wire mode.

**■ 2-wire operation**

For 2-wire operation, set 03-00 (S1 terminal selection) to 0 and 03-01 (S2 terminal selection) to 1.

Terminal S1	Terminal S2	Operation
Open	Open	Stop Inverter / FWD Active
Closed	Open	Run Forward
Open	Closed	Run Reverse
Closed	Closed	Stop Inverter, Display EF9 Alarm after 500ms

Parameter 13-08 to 2, 4 or 6 for 2-wire program initialization, multi-function input terminal S1 is set to forward , operation/ stop, and S2 is set for reverse, operation / stop.

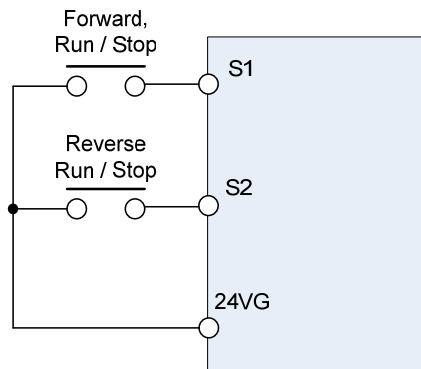

Figure 4.4.1 wiring example of 2-wire

■ 3-wire operation

For 3-wire operation set any of parameters 03-02 to 03-07 (terminal S3 ~ S8) to 26 to enable 3-wire operation in combination with S1 and S2 terminals set to run command and stop command.

Parameter 13-08 to 3, 5 or 7 for 3-wire program initialization, multi-function input terminal S1 is set to run operation, S2 for stop operation and S7 for forward/reverse command.

**Note:** Terminal S1 must be closed for a minimum of 50ms to activate operation.

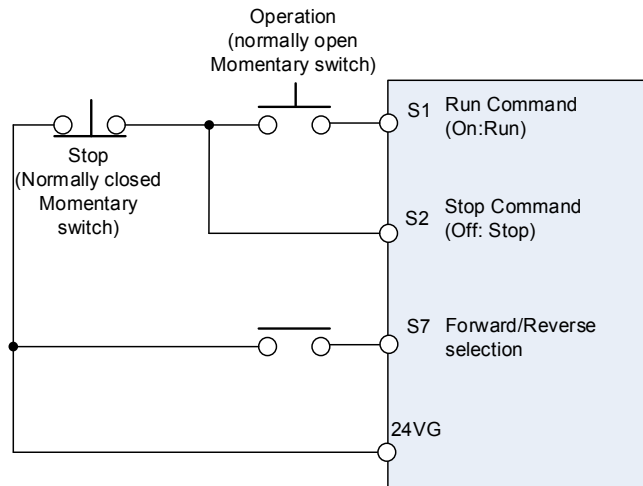

Figure 4.4.2 wiring example of 3-wire

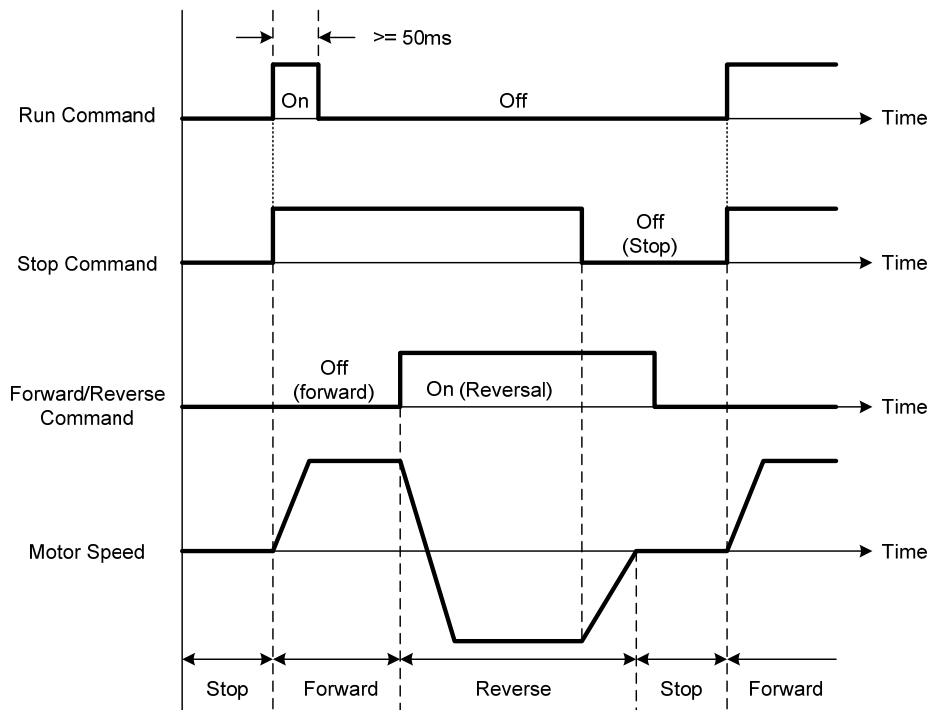
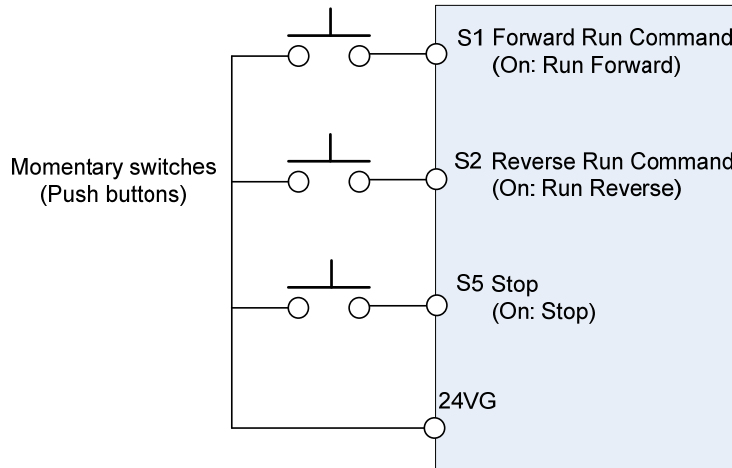

Figure 4.4.3 3-wire operation

■ **2-wire operation with hold function**

To enable 2-wire operation with hold function, set any of parameters 03-02 to 03-07 (terminal S3 ~ S8) to 53. When this mode is enabled set terminal S1 (03-00=0) to forward and S2 (03-01=1) to reverse run command.



**Note:** Terminal S1, S2 and S5 must be closed for a minimum of 50ms to activate operation.

**Note:** The inverter will display SE2 error when input terminals S1-S8 is set to 53 and 26 simultaneously.

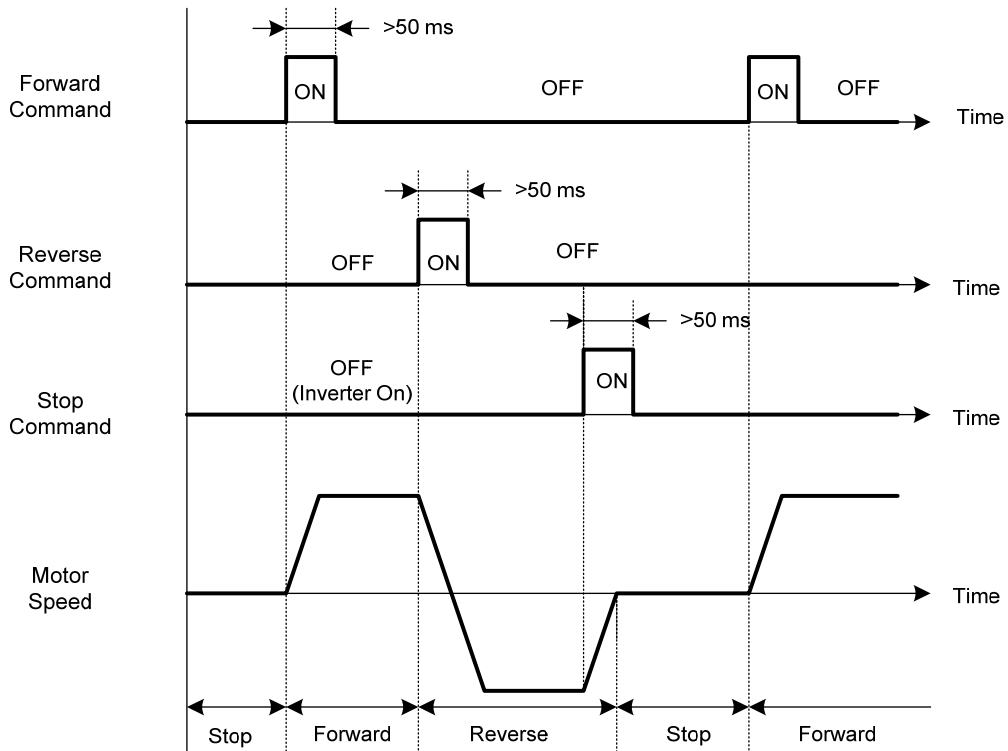

**00-02=2: Communication control**

The inverter is controlled by the RS-485 port. Refer to parameter group 9 for communication setup.

**00-02=3: PLC control**

The inverter is controlled by the inverter built-in PLC logic. Refer to section 4.5.

**00-02=4: RTC control**

The inverter is controlled by RTC timer when run command is set to RTC. Refer to function group 16.

00-04	Language
Range	<b>0:</b> English <b>1:</b> Simplified Chinese <b>2:</b> Traditional Chinese <b>3:</b> Turkish

It is required to be with LCD keypad to display the language selection of parameter 00-04.

**00-04=0**, LCD keypad displays in English.

**00-04=1**, LCD keypad displays in Simplified Chinese.

**00-04=2**, LCD keypad displays in Traditional Chinese.

**00-04=3**, LCD keypad displays in Turkish.

**Note:** It will not restore to the default value when this parameter performs initialization.

00-05	Main Frequency Command Source Selection
00-06	Alternative Frequency Source Selection
Range	<b>0:</b> Keypad <b>1:</b> External control (analog) <b>2:</b> Terminal UP / DOWN <b>3:</b> Communication control <b>4:</b> Pulse input <b>5:</b> Reserved <b>6:</b> RTC <b>7:</b> AI2 Auxiliary Frequency <b>8:</b> Manual Pulse Generator (MPG)

(only in parameter 00-05)

**00-05/00-06= 0: Keypad**

Use the digital operator to enter frequency reference or to set parameter 05-01 (frequency reference 1) as alternative frequency reference source. Refer to section 4.1.4 for details.

**00-05/00-06= 1: External control (Analog Input)**

Use analog reference from analog input AI1 or AI2 to set the frequency reference (as shown in Figure 4.4.4). Refer to parameters 04-00 to select the signal type.

AI1 – Analog Input 1	AI2 – Analog Input 2	04-00 Setting (Default = 1)	Dipswitch SW2 (H & C type) or SW4 (E & G type) (Default 'V')
0 ~ 10V	0 ~ 10V	0	Set to 'V'
0 ~ 10V	4 ~ 20mA	1	Set to 'I'
-10 ~ 10V	0 ~ 10V	2	Set to 'V'
-10 ~ 10V	4 ~ 20mA	3	Set to 'I'
4 ~ 20mA	0 ~ 10V	4	Set to 'V'
4 ~ 20mA	4 ~ 20mA	5	Set to 'I'

**Note:** Set parameter 04-05 to 10 to add frequency reference using AI2 to AI1.

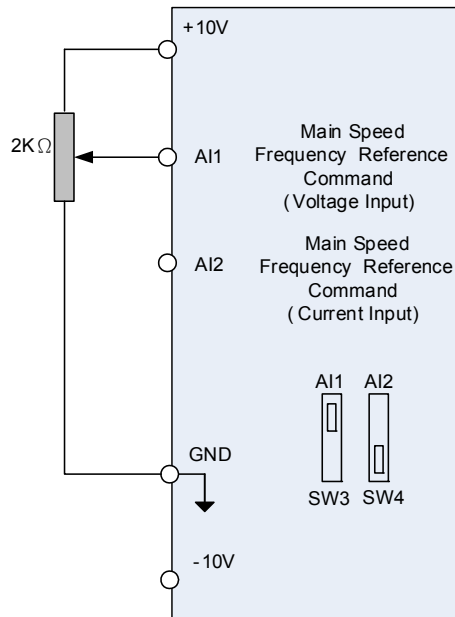

**Figure 4.4.4 Analog input as main frequency reference command (For H & C type)**

**00-05/00-06= 2: Terminal UP / DOWN**

The inverter accelerates with the UP command closed and decelerates with the DOWN command closed. Please refer to parameter 03-00 ~ 03-07 for additional information.

**Note:** To use this function both the UP and DOWN command have to be selected to any of the input terminals.

**00-05/00-06= 3: Communication control**

The frequency reference command is set via the RS-485 communication port using the MODBUS RTU protocol.

Refer to parameter group 9 for additional information.

**00-05/00-06= 4: Pulse input**

To use this function a pulse train input is required to be connected to the PI input and GND (see fig. 4.4.5).

Set parameter 03-30 to 0 to use the pulse input as frequency reference. Refer to parameters 03-31 to 03-34 for pulse input scaling.

PI input terminal, built-in resistance, is not required to connect the resistance if open collector input mode is used.

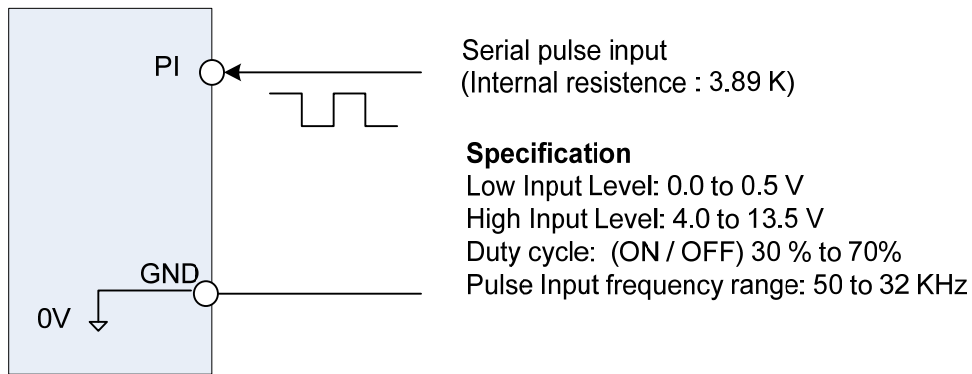

**Figure 4.4.5 Frequency reference from pulse input**

**00-05/00-06= 6: RTC**

Enables RTC control, reference frequency is controlled by the RTC function, Refer to parameter group 16 for RTC setup.

**00-05/00-06= 7: AI2 Auxiliary Frequency**

When 04-05 is set to 0 (auxiliary frequency), frequency command is provided by multi-function analog input AI2 and the maximum output frequency (01-02, Fmax) = 100%.

When 04-05 is not set to 0, the frequency is 0. Refer to the parameters of 03-00~03-07 for multi-speed descriptions.

**00-05= 8: Manual Pulse Generator (MPG)**

Frequency command depends on the manual pulse generator (MPG). The speed of MPG is multiplied by the speed magnification calculation (parameter 20-43) and limited by the speed command limit (parameter 20-44). The MPG command is required to be installed the induction motor PG card (JN5-PG-L or JN5-PG-O).

00- 07	Main and Alternative Frequency Command modes
<b>Range</b>	<b>0:</b> Main frequency <b>1:</b> Main frequency + alternative frequency

When 00-07 is set to 0, the reference frequency is set by the main reference frequency selection of parameter 00-05. When 00-07 is set to 1 the reference frequency is sum of the main reference frequency (00-05) and alternative frequency (00-06).

**Note:** The inverter will display the SE1 error when 00-07 = 1 and parameter 00-05 and 00-06 are set to the same selection.

When parameter 00-06 is set to 0 (Keypad) the alternative frequency reference is set by parameter 05-01 (Frequency setting of speed-stage 0).



<b>00- 08</b>	<b>Communication frequency command – READ ONLY</b>
<b>Range</b>	0.00~599.00 Hz

Display the frequency reference when 00-05 or 00-06 is set to communication control (3).

<b>00-09</b>	<b>Communication frequency command memory</b>
<b>Range</b>	0: Don't save when power supply is off. (00-08) 1: Save when power is off. (00-08)

**Note:** This parameter is only enabled in communication mode.

<b>00-10</b>	<b>Minimum frequency detection</b>
<b>Range</b>	0: Show warning if lower than minimum frequency 1: Run as minimum frequency if lower than minimum frequency

00-10=0: Frequency command is lower than 01-08 (Minimum Output Frequency of Motor 1), it shows STP0 warning.

00-10=1: Frequency command is lower than 01-08 (Minimum Output Frequency of Motor 1), inverter run as Minimum Output Frequency of Motor 1.

<b>00- 11</b>	<b>Selection of PID Lower Limit Frequency</b>
<b>Range</b>	<b>【0】</b> : PID is bound to lower limit frequency when inverter sleeps. <b>【1】</b> : PID is bound to 0Hz when inverter sleeps.

When inverter gets to sleep,

**00-11=0:** PID is bound to lower limit frequency (00-13).

**00-11=1:** PID is bound to 0 Hz.

**Note:** Refer to descriptions of parameters 10-17~10-20 for details when inverter gets to sleep.

<b>00-12</b>	<b>Upper Limit Frequency</b>
<b>Range</b>	0.1~109.0 %

Set the maximum frequency reference as a percentage of the maximum output frequency. Maximum output frequency depends on motor selection.

Motor 1: Maximum frequency parameter 01-02.

Motor 2: Maximum frequency parameter 01-16.

<b>00-13</b>	<b>Lower Limit Frequency</b>
<b>Range</b>	0.0~109.0 %

Set the minimum frequency reference as a percentage of the maximum output frequency. Maximum output frequency depends on motor selection. Motor 1: Maximum frequency is set by parameter 01-02 and Motor 2 Maximum frequency is set by parameter 01-16.

**Notes:**

- When the frequency lower limit is set to a value greater than 0 and the inverter is started the output frequency will accelerate to the frequency lower limit with a minimum frequency defined by parameter 01-08 for motor 1 and parameter 01-22 for motor 2.
- Frequency upper limit has to be greater or equal to the frequency lower limit otherwise the inverter will display a SE01 (Set range error).
- Frequency upper and lower limit is active for all frequency reference modes.

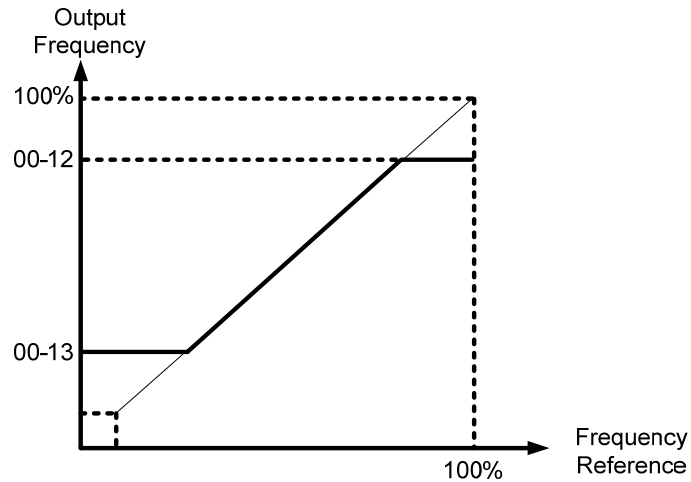

**Figure 4.4.6 Frequency reference upper and lower limits**

**Note:** The maximum frequency setting in the keypad is according to parameter 01-02 (Maximum Output Frequency) and 00-12 (Upper Frequency limit). The upper frequency limit is not over than 599Hz and AI frequency is 100% to parameter 01-02.

<b>00-14</b>	<b>Acceleration time 1</b>
<b>Range</b>	0.1~6000.0 Sec
<b>00-15</b>	<b>Deceleration time 1</b>
<b>Range</b>	0.1~6000.0 Sec
<b>00-16</b>	<b>Acceleration time 2</b>
<b>Range</b>	0.1~6000.0 Sec
<b>00-17</b>	<b>Deceleration time 2</b>
<b>Range</b>	0.1~6000.0 Sec
<b>00-21</b>	<b>Acceleration time 3</b>
<b>Range</b>	0.1~6000.0 Sec
<b>00-22</b>	<b>Deceleration time 3</b>
<b>Range</b>	0.1~6000.0 Sec
<b>00-23</b>	<b>Acceleration time 4</b>
<b>Range</b>	0.1~6000.0 Sec
<b>00-24</b>	<b>Deceleration time 4</b>
<b>Range</b>	0.1~6000.0 Sec
<b>00-25</b>	<b>Switch-Over Frequency of Acceleration and Deceleration Time 1 and Time 4</b>
<b>Range</b>	0.00~599.00 Hz

Acceleration time is the time required to accelerate from 0 to 100% of maximum output frequency.  
Deceleration time is the time required to decelerate from 100 to 0% of maximum output frequency.  
Motor 1: Maximum frequency is set by parameter 01-02 and Motor 2 Maximum frequency is set by parameter 01-16.

**Note:** Actual acceleration and deceleration times can be affected by the inverter driven load.

The default values for the acceleration, deceleration times are dependent on the inverter size.

Size		Acceleration / Deceleration Default Value
200V series	400V series	
1~10HP	1~15HP	10s
15~20HP	20~30HP	15s
30~150HP	40~425HP	20s

Size		Acceleration / Deceleration Default Value
575V series	1~3HP	10s
	5~10HP	20s
690V series	15~40HP	25s
	50~535HP	30s

**A: Select acceleration and deceleration time via the digital input terminals**

The following table shows the acceleration / deceleration selected when the digital input function Accel/ Decel time 1 (#10) and Accel/Decel time 2 1(#30) are used.

**Table 4.4.1 acceleration / deceleration time selection**

Accel/decel time 2 (Set 03-00 ~ 03-07 = 30)	Accel/decel time 1 (Set 03-00 to 03-07 = 10)	Acceleration time	Deceleration time
0	0	Tacc1 (00-14)	Tdec1 (00-15)
0	1	Tacc2 (00-16)	Tdec2 (00-17)
1	0	Tacc3 (00-21)	Tdec3 (00-22)
1	1	Tacc4 (00-23)	Tdec4 (00-24)

0: OFF, 1: ON

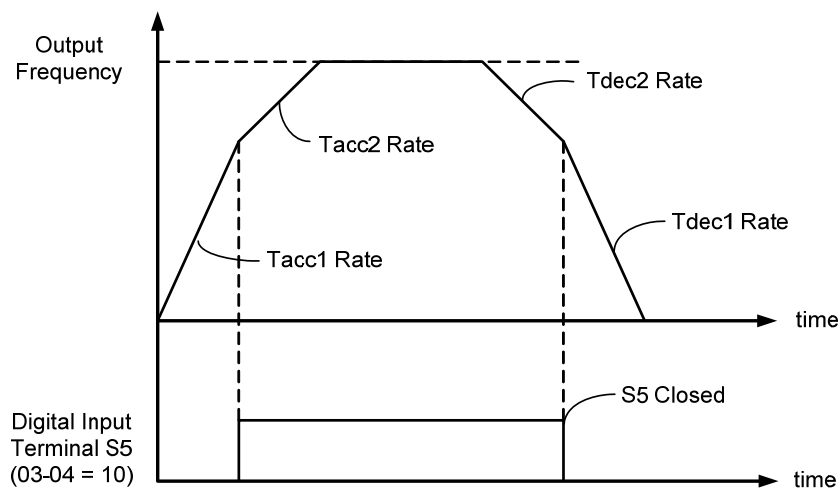

**Figure 4.4.7: Terminal S5 switch between Tacc1/Tacc2 and Tdec1/Tdec2**

**B. Switch of Acceleration/Deceleration time according to motors**

03-00~03-07 set to 40 (Switching between motor 1/motor 2), it can switch motors by digital input. This function I only for V/F control mode and V/F +PG card mode.

Chose for motor1, acceleration and deceleration time of multi-speed depends on Figure 4.4.1.  
 Chose for motor, acceleration and deceleration time of multi-speed depends on the following Figure.

Chose motor2		
acceleration and deceleration time 1 (Set 03-00 to 03-07 = 10)	acceleration	deceleration
0	Tacc3(00-21)	Tdec3(00-22)
1	Tacc4(00-23)	Tdec4(00-24)

**C. Automatically switch acceleration/deceleration time**

When output frequency equals to the value of 00-25, it follows the value of 00-25 to automatically switch acceleration/ deceleration time1 and time2.Please refer to the following Figure4.4.8.

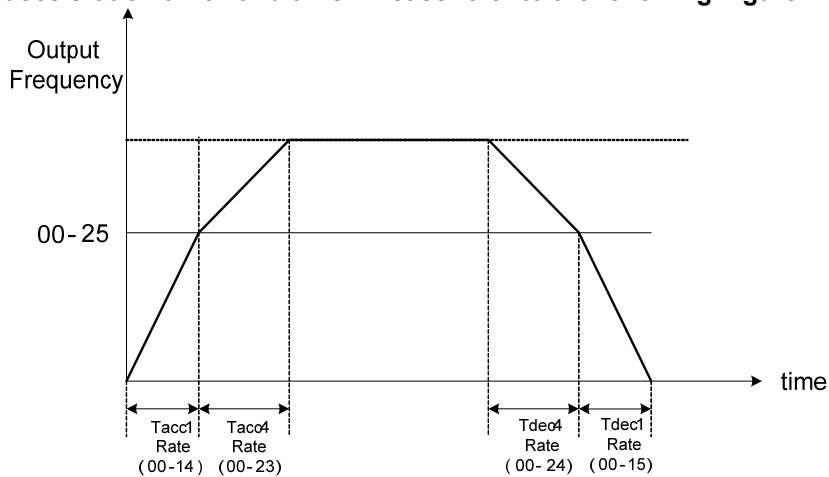

**Figure 4.4.8 automatically switch Acceleration/Deceleration time**

- When output frequency  $F_{out} < 00-25$  : **Acceleration/deceleration time = Acceleration time1/ deceleration time 1**(00-14 and 00-15).
- When output frequency  $F_{out} \geq 00-25$  : **Acceleration/deceleration time = Acceleration time4/ deceleration time 4**(00-23 and 00-24)

When 03-00~03-07 set to 10 (Acceleration/ Deceleration Time Selection 1) and 03-00~03-07 set to 3 (Acceleration/ Deceleration Time Selection 2), the priority is higher than 00-25.

<b>00-18</b>	<b>Jog frequency</b>
<b>Range</b>	0.00~599.00 Hz

<b>00-19</b>	<b>Jog acceleration time</b>
<b>Range</b>	0.1~6000.0 Sec

<b>00-20</b>	<b>Jog deceleration time</b>
<b>Range</b>	0.1~6000.0 Sec

Jog acceleration time (00-19) is the time required to accelerate from 0 to 100% of maximum output frequency. Jog deceleration time (00-20) is the time required to decelerate from 100 to 0% of maximum output frequency. Motor 1: Maximum frequency is set by parameter 01-02 and Motor 2 Maximum frequency is set by parameter 01-16.

When run command selection is external terminal control (00-02=1) and the inverter uses the jog frequency (00-18, default 6.0 Hz) as its frequency reference with 03-00~03-07=6 or 7(6: Forward jog run command 7: Reverse jog run command).The motor will run by the setting.

<b>00-26</b>	<b>Emergency stop time</b>
<b>Range</b>	0.0~6000.0 Sec

The emergency stop time is used in combination with multi-function digital input function #14 (Emergency stop). When emergency stop input is activated the inverter will decelerate to a stop using the Emergency stop time (00-26) and display the [EM STOP] condition on the keypad.

**Note:** To cancel the emergency stop condition the run command has to be removed and emergency stop input deactivated.

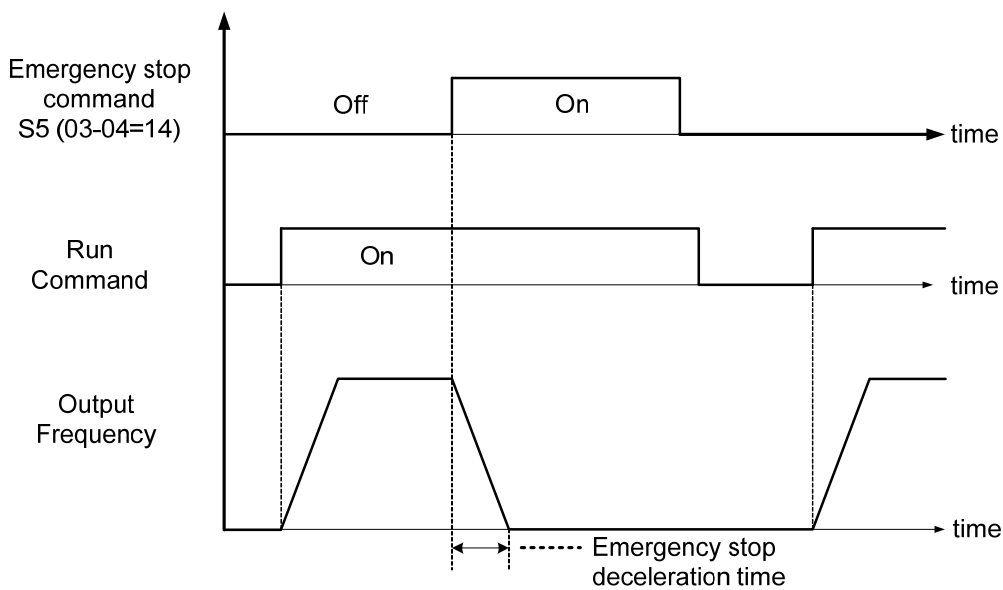

**Figure 4.4.9 Emergency stop example**

Multi-function digital input terminals (03-00 ~ 03-07) are set to 14: When the emergency stop input is activated the inverter will decelerate to a stop using the time set in parameter 00-26.

**Note:** After an emergency stop command the run command and emergency stop command have to be removed before the inverter can be restarted. Please refer to Figure 4.4.9. The emergency stop function can be used to stop inverter in case of an external event.

Multi-function digital input terminals (03-00 ~ 03-07) set to 15: When the base block input is activated the inverter output will turn off and the motor will coast to a stop.

<b>00-27</b>	<b>HD/ND selection</b>
<b>Range</b>	<b>0: HD (Heavy Duty / Constant Torque) 1: ND (Normal Duty / Variable Torque)</b>

The inverter overload curve, carrier frequency, stalls prevention level, rated input/output current and maximum frequency are automatically set based on the inverter duty (HD/ND) selection.

Please refer to table 4.4.2 for detailed information.

**Table 4.4.2 Heavy Duty (Constant torque) / Normal Duty (Variable torque)**

<b>00-27</b>	<b>Overload capacity</b>	<b>Carrier frequency</b>	<b>Maximum output frequency</b>	<b>Stall prevention level</b>	<b>Rated input / output current</b>
0 (Heavy Duty)	150%, 1min	2-16KHz (KVA dependent)	599.00Hz	150% (08-00, 08-01)	Refer to section 3.7
1 (Normal Duty)	120%, 1min	2-16KHz (KVA dependent)	120.00Hz	120% (08-00, 08-01)	

**00-27= 0: Heavy Duty Mode**

Select V/F curve (Group 1) and enter motor data (Group 2) to match the application. In Heavy Duty mode the maximum output frequency is 599Hz for all control modes, except for SLV mode (Sensorless Vector / Open Loop Vector Mode) where the maximum output frequency is limited based on the inverter rating, see table below.

<b>Horsepower</b>	<b>Special circumstances</b>	<b>Maximum output frequency</b>
220V 1~10HP, 440V 1~15HP	-	150Hz
220V 15~25HP, 440V 20HP	-	110Hz
440V 25~30HP	-	100Hz
220V 30~150HP, 440V 40~425HP,	Carrier frequency (11-01) set 8KHz or below	100Hz
220V 30~100HP, 440V 40~175HP,	Carrier frequency (11-01) set 8KHz or higher	80Hz
575V 1~10HP	-	150Hz
575V/690V 15~40HP	-	110Hz
575V/690V 50~535HP	Carrier frequency (11-01) set 8KHz or below	100Hz
575V/690V 50~535HP	Carrier frequency (11-01) set 8KHz or below	80Hz

**00-27= 1: Normal Duty Mode**

In normal duty mode only applies to control modes V/F and V/F + PG. All other modes must use the Heavy Duty settings.

<b>00-28</b>	<b>Command characteristic selection of master frequency</b>
<b>Range</b>	<b>0:</b> Positive characteristic (0-10V / 4-20mA = 0 -100%) <b>1:</b> Negative / inverse characteristic (0-10V / 4~20mA = 100 - 0%)

**00-28= 0:** Positive reference curve, 0 – 10V / 4 – 20mA = 0 – 100% main frequency reference.

**00-28= 1:** Negative reference curve, 0 – 10V / 4 – 20mA = 100 – 0% main frequency reference.

**Note 1:** Selection applies to analog input AI1 and AI2.

**Note 2:** AI2 will be useful for analog input frequency command when 04-05=0.

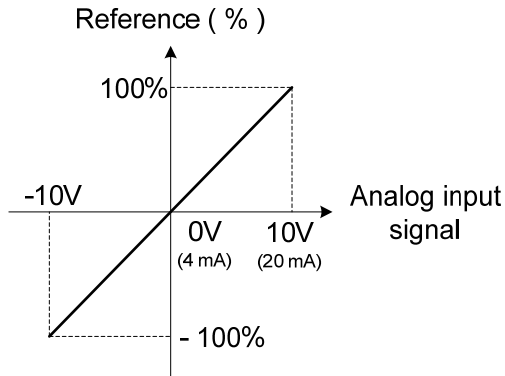

(a) Normal / Positive Characteristics

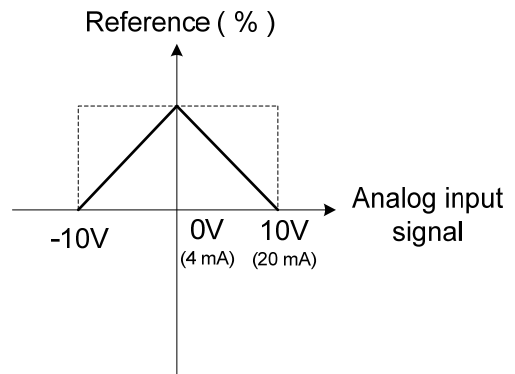

(b) Inverse / Negative Characteristics

**Figure 4.4.10 Positive/negative analog input as main frequency reference command.**

<b>00-29</b>	<b>Zero-speed operation selection</b>
<b>Range</b>	<b>0:</b> Operation based on frequency command <b>1:</b> Stop <b>2:</b> Operation based on lowest frequency <b>3:</b> Zero-speed operation

Refer to figure 4.4.11 for zero-speed operation in sensor vector mode (SV / PMSV) (00-00=3 or 00-00=4).



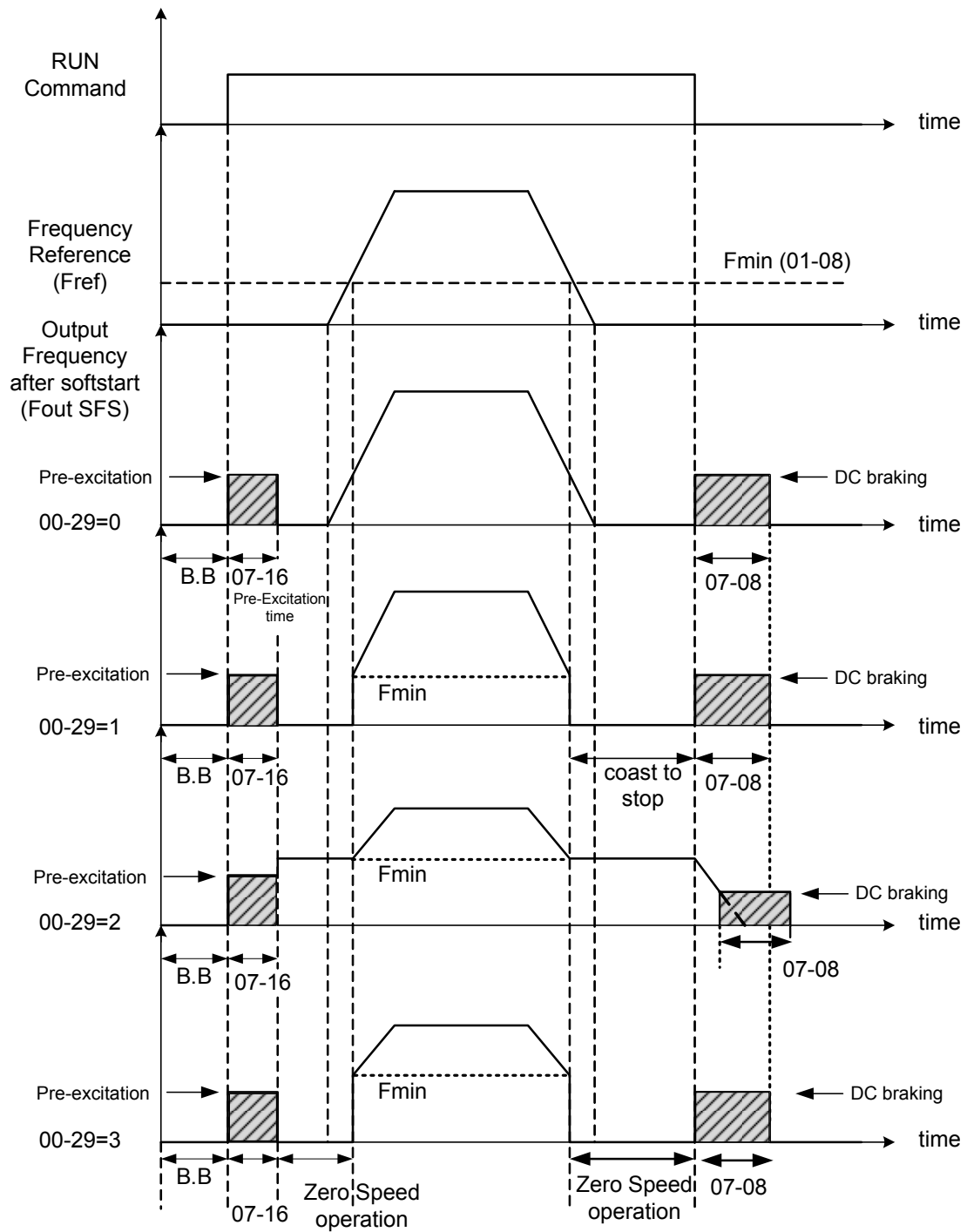

**Figure 4.4.11 Zero-speed operation of sensor vector (SV) and PM vector (PMSV) mode**

DC injection braking activates when the run command is removed and output frequency falls below the DC injection braking start frequency (07-06). DC injection braking will be active for the time set in parameter 07-08 DC injection braking execution time. Refer to figure 4.4.62 for more information on the pre-excitation operation.

<b>00-32</b>	<b>Application Selection</b>
<b>Range</b>	<b>0:</b> General <b>1:</b> Reserved <b>2:</b> Conveyor <b>3:</b> Exhaust fan <b>4:</b> Reserved <b>5:</b> Compressor <b>6:</b> Hoist- * <b>Consult TECO for the settings</b> <b>7:</b> Crane- * <b>Consult TECO for the settings</b> <b>8:</b> Manual Pulse Generator (MPG)

**Note:** If set 00-32 back to 0, 2 wire initialization (60Hz)(230/400V) setting (13-08=11) will be executed.

**Note:** Before to set up 00-32 Application, it should do initialized setting (parameter 13-08) first. When setting 00-32, the I/O port function changed automatically. To avoid accident, be sure to confirm the I/O port signal of inverter and external terminal control

#### 00-32=2: Conveyor

Parameter	Name	Value
00-00	Control mode selection	0: V/F
00-14	Acceleration time 1	3.0 sec
00-15	Deceleration time 1	3.0 sec
00-27	HD/ND selection	0: HD
08-00	Stall prevention function	xx0xb: Stall prevention during deceleration

#### 00-32=3: Exhaust fan

Parameter	Name	Value
00-00	Control mode selection	0: V/F
11-00	Direction lock selection	1: Forward direction only
00-27	HD/ND selection	1: ND
01-00	V/F curve selection	F
07-00	Momentary power loss/ fault restart selection	1: Enable
08-00	Stall prevention function	xx0xb: Stall prevention during deceleration

#### 00-32=5: Compressor

Parameter	Name	Value
00-00	Control mode selection	0: V/F
11-00	Direction lock selection	1: Forward direction only
00-14	Acceleration time 1	5.0 sec
00-15	Deceleration time 1	5.0 sec
00-27	HD/ND selection	0: HD
01-00	V/F curve selection	F
07-00	Momentary power loss/ fault restart selection	1: Enable
08-00	Stall prevention function	xx0xb: Stall prevention during deceleration

**00-32=6: Hoist**

Parameter	Name	Value
00-00	Control mode selection	2: SLV
00-05	Main Frequency command source selection	0: keypad
11-43	Hold Frequency at start	3.0 Hz
11-44	Frequency hold Time at start	0.3 sec
00-14	Acceleration time 1	3.0 sec
00-15	Deceleration time 1	3.0 sec
11-01	Carrier frequency	5.0kHz
05-01	Frequency setting of speed-stage 0	6.0 Hz
05-02	Frequency setting of speed-stage 1	30.0 Hz
05-03	Frequency setting of speed-stage 2	60.0Hz/ 50.0 Hz
03-28	Photo-coupler output	5 : frequency detection 2
07-18	Minimum baseblock time	0.3 sec
08-00	Stall prevention function	xx1x: Stall prevention ineffective in deceleration
03-13	Frequency detection level	2.0 Hz
03-14	Frequency detection width	0.1 Hz
08-18	Selection of low-torque operation	0: Deceleration to stop
08-19	Level of low-torque detection	2 %
08-20	Time of low-torque detection	0.5 sec
08-09	Selection of input phase loss protection	1 : Enable
08-10	Selection of output phase loss protection	1 : Enable

**00-32=7: Crane**

Parameter	Name	Value
00-00	Control mode selection	0: V/F
00-05	Main Frequency Command Source Selection	0: keypad
00-14	Acceleration time 1	3.0 sec
00-15	Deceleration time 1	3.0 sec
00-27	HD/ND Mode selection	0: HD
11-01	Carrier frequency	5.0kHz
05-01	Frequency setting of speed-stage 0	6.0 Hz
05-02	Frequency setting of speed-stage 1	30.0 Hz
05-03	Frequency setting of speed-stage 2	60.0 Hz/ 50.0Hz
03-04	Multi-function terminal Function setting-S5	2: Multi-speed/position setting command 1
03-05	Multi-function terminal Function setting-S6	3: Multi-speed/position setting command 2
03-28	Photo-coupler output	23: Source of operation command
08-00	Stall prevention function	xx1x : Stall prevention ineffective in deceleration
08-09	Selection of input phase loss protection	1: Enable
08-10	Selection of output phase loss protection	1: Enable

**00-32=8: Manual Pulse Generator (MPG)**

Parameter	Name	Value
00-00	Control mode selection	0: V/F
00-02	Main Run Command Source Selection	1: External Terminal (Control Circuit)
00-05	Main Frequency Command Source Selection	8: Manual Pulse Generator (MPG)
00-16	Acceleration Time 2	0.1 sec
00-17	Deceleration Time 2	0.1 sec
01-00	V/F Curve Selection	F
03-07	Multi-Function Terminal Function Setting-S8	67: Manual Pulse Generator Mode Switch
07-09	Stop Mode Selection	1: Coast to Stop
07-18	Minimum Base block Time	0.1 sec
07-46	DC Injection Current Limit	100%
08-00	Stall Prevention Function	xx1xb: Stall prevention is disabled in deceleration.
11-62	Selection of Preventing Oscillation	2: Mode3
20-08	ASR Delay Time	0
20-27	PG Pulse Number	100
20-43	MPG Speed Magnification Calculation	20
20-44	MPG Speed Command Limit	6.0 Hz

00- 33	Modified Parameters
Range	0: Disable 1: Enable

**Note:** It is only for LCD keypad.

This parameter automatically lists all the adjusted parameters. When the default value is adjusted and 00-33=1, it will list all the parameters different from default values in the advanced modes and these parameters can be edited directly. The adjusted parameters list displays only when 00-33 is set from 0 to 1 or 00-33=1 at start up.

If user wants to restore to the original editing interface, it is only required to set parameter 00-33=0.

This function can display 250 adjusted parameters. If they are more than 250 parameters, it will list the adjusted parameters before 250.

**Example: Set 00-03 (alternative run command source selection) to be different from the default value.**

Steps	LCD Display	Descriptions
1	Group 00 Basic Func. 01 V/F Pattern 02 Motor Parameter	The starting parameter group (00) in the setting modes of ▲ (Up)/ ▼ (Down) selection groups.

2	PARA 00 -01. Motor Direction -02. RUN Source [REDACTED]	Press READ/ ENTER key and ▲ (Up)/ ▼ (Down) to select alternative run command source (00-03).
3	Edit 00-00 Sub RUN Source [REDACTED] Terminal (0 ~4) <2>	Press READ/ ENTER key and adjust the value. The selected setting value will flash.
4	PARA 00 [REDACTED] -41. User P1 -42. User P2	Press DSP/ FUN to the menu of modified parameters (00-33).
5	Edit 00-33 Modify parameter [REDACTED] Enable (0 ~1) <0>	Press READ/ ENTER key to adjust the value to 1 (The modified parameter is enabled.) The selected setting value will flash.
6	Modify 00 00-03. Sub RUN Source [REDACTED]	Press DSP/ FUN back to the advanced modes.

#### User parameter setting (00-41 to 00-56) (only for LCD keypad)

00- 41	User parameter 0
00- 42	User parameter 1
00- 43	User parameter 2
00- 44	User parameter 3
00- 45	User parameter 4
00- 46	User parameter 5
00- 47	User parameter 6
00- 48	User parameter 7
00- 48	User parameter 8
00- 50	User parameter 9
00- 51	User parameter 10
00- 52	User parameter 11
00- 53	User parameter 12
00- 54	User parameter 13
00- 55	User parameter 14
00- 56	User parameter 15

- User parameter (00-41 ~ 00-56) can select 16 sets of parameters (group 00 ~ 22, but except 00-00/ 00-41~00-56/ group 17) and put them into the list to do the fast access setting.
- When the access setting of parameter 13-06 is set to 1, user parameter 00-41 ~ 00-56 can be displayed and changed.
- User parameter 00-41 ~ 00-56 can be changed in the advanced modes, exclusive of being in operation.
- Set value in the parameter of 00-41 ~ 00-56 and set 13-06 to 1.

- When 13-06=1, only parameter of 00-00 ~ 00-56 can be set or read in the advanced modes. 13-06=1 is enabled in the parameter setting of 00-41~00-56.
- When user would like to leave the screen of user parameters, press RESET key and then DSP/FUN key to select parameter Group 13.

**Example 1: Set 03-00 (Multi-function terminal Function Setting-S1) to user parameter 0 (00-41)**

Steps	LCD Display	Descriptions
1	Group 00 Basic Func. 01 V/F Pattern 02 Motor Parameter	Select the start parameter group (00) in the advanced modes.
2	PARA 00 -42. User P1 -43. User P2	Press (READ/ ENTER) key and ▲ (Up) / ▼ (Down) to select user parameter 0 (00-41).
3	Edit 00-41 User P0=00-41 00-41 User P0 <00-01 - 24-07>	Press (READ/ ENTER) key to the screen of data setting/ read. * The selected setting value will flash.
4	Edit 00-41 User P0=00-41 03-0 S1 Function Sel <00-01 - 24-07>	Press ◀ (Left) / ▶ (Right) and ▲ (Up) / ▼ (Down) key to set the value to 03-00 ( Multi-function terminal Function Setting-S1)
5	Edit 00-41 User P0= 03- 0 03-00 S1 Function Sel <00-01 - 24-07>	Press (READ/ ENTER) key to save 03-00 and the digit stops flashing and the screen displays <b>User P0 = 03-00</b> ; 03-00 (Multi-function terminal Function Setting-S1) has been defined as 00-41. Few seconds later, the selected digit will flash again.
6	Monitor Freq Ref 12-16=000.00Hz ----- 12-17=000.00Hz 12-18=0000.0A	Press (DSP/ FUN) key to the display of main screen. * If users do not press BACK key in one minute, the screen will automatically display the monitor mode shown as the left figure. The automatically return time can be set via 16-06.

**Example 2: After one or more parameters in 00-41 ~ 00-56 are set, user parameters settings are as follows.**

Step	LCD Display	Descriptions
1	Group 13 Driver Status 14 PLC Setting 15 PLC Monitor	Select the start parameter group (03) in the advanced modes.
2	PARA 13 -07. Password 1 -08. Initialize	Press (READ/ ENTER) and ▲ (Up) / ▼ (Down) key to enter the access level of parameter (13-06).
3	Edit 13-06 Access Level ----- 1 User Level (0~2) < 2 >	Press (READ/ ENTER) key to enter the screen of the data setting/ read. * The selected setting value will flash.
4	—ADV— G01-02 Access Level █ User Level (0-2) < 2 >	Press ▲ (Up) / ▼ (Down) key to change setting value to 1 (13-06=1, user level) and Press (READ/ ENTER) key to save the setting value (03-00). Then, the digit stops flashing and the screen displays the setting value. Few seconds later, the selected digit will flash again.  User level (13-06=1) can be set by one or more parameters in the user parameters of 00-41 ~ 00-56. If users do not set user parameters, 13-06 will not be set in the user level (setting value=1).
5	PARA 13 █	Press (DSP/FUN) key to the display of subdirectory.
6	Group █	Press (DSP/FUN) key to the display of group directory. It is required to press ▲ (Up) key to select Group 00 User Function.
7	Monitor Freq Ref 12-16=000.00Hz ----- 12-17=000.00Hz ----- 12-18=0000.0A	Press (DSP/ FUN) key to enter the main screen. If user would like to leave the screen of user parameters, press RESET key and then DSP/FUN key to select parameter Group 13. Hotkeys are only enabled in inverter software V1.4.
8	Group 00. User Function00 User █	13-06 can be selected to be adjusted so leave parameters or enter parameter group 00 to edit user parameters is allowable.
9	PARA 00 █ S1 Function Sel	Press (READ/ ENTER) key and ▲ (Up) / ▼ (Down) key to select user parameter 0 (00-41) display.

Step	LCD Display	Descriptions
10	Edit <span style="float: right;">00-41</span> <b>S1 Function Sel</b> 0 <b>2-Wire (FWD-RUN)</b> (00~57) < 00 > <span style="float: right;">&lt; 03-00 &gt;</span>	Press (READ/ ENTER) key to enter the screen of data setting/ read. *The selected setting value will flash.  In this example, 03-00 (Multi-function terminal Function Setting-S1) has been defined as user parameters (00-41). The right bottom location displays the original parameter group.
	Edit <span style="float: right;">00-41</span> <b>S1 Function Sel</b> 0 <b>FJOG</b> (00~57) < 00 > <span style="float: right;">&lt; 03-00 &gt;</span>	Press ▲ (Up) / ▼ (Down) key to change the setting value to 2. Use (READ/ ENTER) key to save the setting value.  When the selected setting value does not flash again, the setting value will be saved to 00-41 and 03-00 simultaneously.
12	Monitor <b>Freq Ref</b> 12-16=000.00Hz ----- 12-17=000.00Hz ----- 12-18=0000.0A	Press (DSP/FUN) key to the display of main screen.  * If users do not press (DSP/ FUN) key in one minute, the screen will automatically display the monitor mode shown as the left figure. The automatically return time can be set via 16-06.

### User Parameter Run Mode Structures

A. Define Parameter Group 0~24 as user parameters except parameter 00-00 and 00-41~00-56.

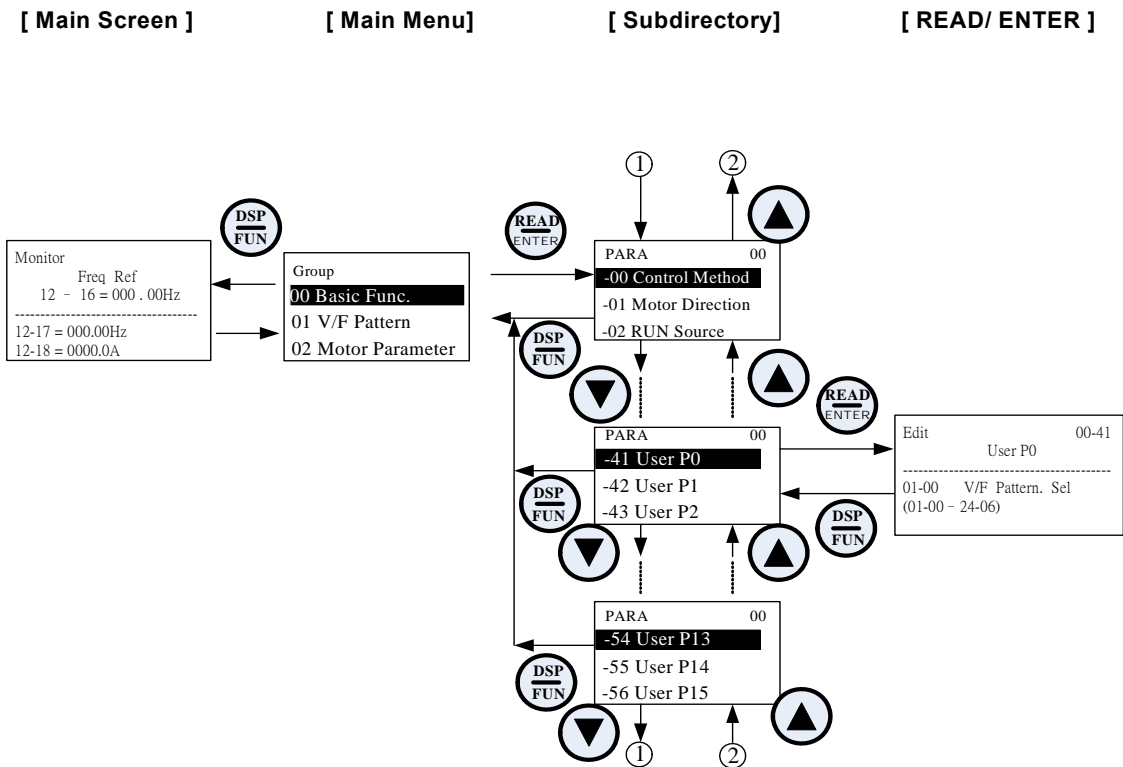



Note: User level (13-06=1) can be set by one or more parameters in the user parameters of 00-41 ~ 00-56.

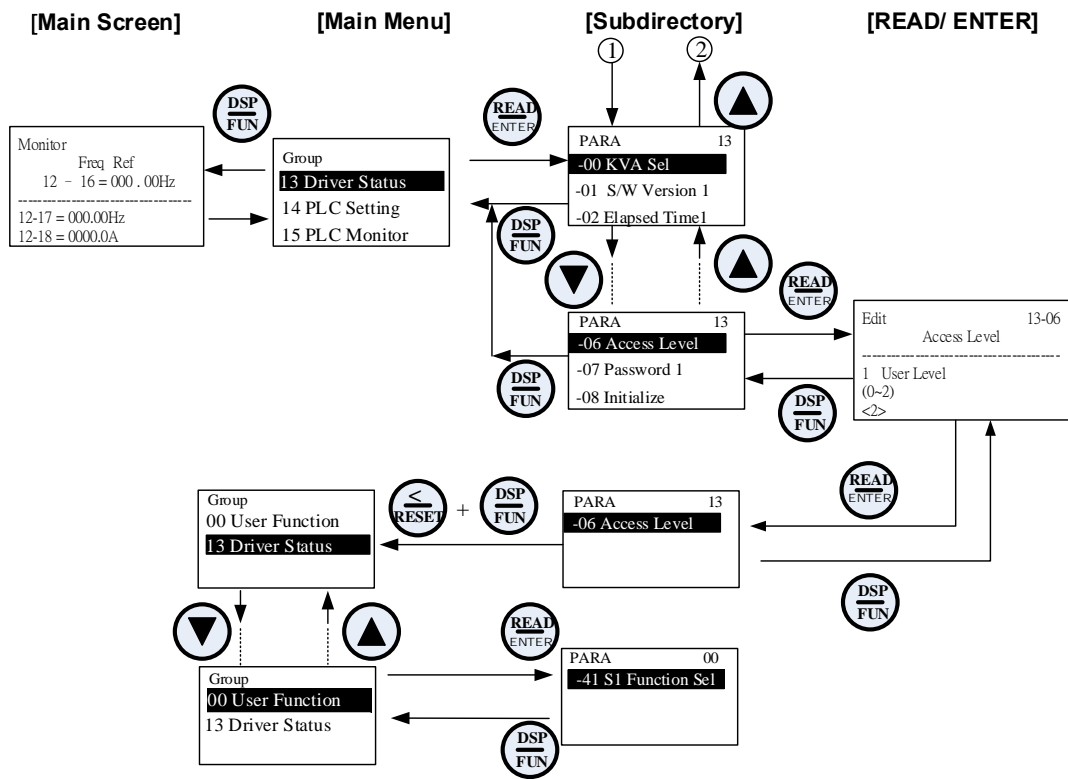

<b>00- 57</b>	<b>SV High Speed Mode</b>
<b>Range</b>	<b>0:</b> SV High Speed Mode 1 <b>1:</b> SV High Speed Mode 2

When the inverter runs in SV mode, SV high speed mode 2 is selected if it is required to use urgent accel./ decel.

### 01-V/F Control Parameters

<b>01-00</b>	<b>V/F curve selection</b>
<b>Range</b>	0~FF

The V/F curve selection is enabled for V/F mode with or without PG or SLV2 mode. Make sure to set the inverter input voltage parameter 01-14.

There are three ways to set V/F curve:

- (1) 01-00 = 0 to E: choose any of the 15 predefined curves (0 to E).
- (2) 01-00 = 0F, use 01-02~01-09 and 01-12~01-13, with voltage limit.
- (3) 01-00 = FF: use 01-02~01-09 and 01-12~01-13, without voltage limit. Refer to the following figure.

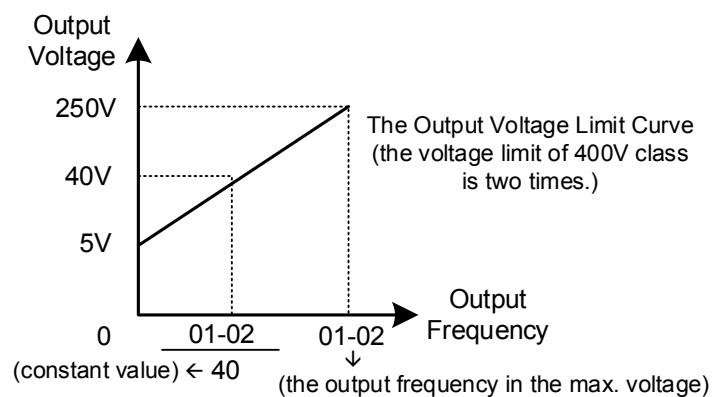

The default parameters (01-02~01-09) are the same when 01-00 is set to F (default) and 01-00 is set to 1.

Parameters 01-02 to 01-13 are automatically set when any of the predefined V/F curves are selected.

**Note:** This parameter is not affected by the initialization parameter (13-08).

Consider the following items as the conditions for selecting a V/F pattern.

- (1) The voltage and frequency characteristic of motor.
- (2) The maximum speed of motor.

Table 4.4.3: 1 - 2HP V/F curve selection (200V)

Type	Specification	01-00	V/F curve	Type	Specification	01-00	V/F curve						
General purpose	50Hz	0		High Starting Torque+	50Hz	8							
		F (50Hz Default setting)	9										
	60 Hz	60Hz Saturatio n	1			60Hz	Low Starting Torque	A					
		50Hz Saturatio n	2				High Starting Torque	B					
Variable Torque Characteristic	72Hz	3		Constant-power torque(Reducer)	90Hz	C							
								50 Hz	Variable Torque 1	4	120Hz	D	
									Variable Torque 2	5			
	Variable Torque 3	6	180Hz		E								
	Variable Torque 4	7											

Table 4.4.4: 3 - 30HP V/F curve selection (200V)

Type	Specification	01-00	V/F curve	Type	Specification	01-00	V/F curve		
General application	50Hz	0		High Starting Torque*	50Hz	8			
		F (50Hz Default setting)	9						
	60Hz	60Hz Saturation	1			60Hz	Low Starting Torque	A	
		50Hz Saturation	2				High Starting Torque	B	
Variable Torque Characteristic	72Hz	3		Constant-power torque (Reducer)	90Hz	C			
		50Hz	Variable Torque 1			4		120Hz	D
	Variable Torque 2		5		60Hz	Variable Torque 3	6		180Hz
	Variable Torque 4	7							

Table 4.4.5: 40HP and above V/F curve selection (200V)

Type	Specification	01-00	V/F curve	Type	Specification	01-00	V/F curve		
General application	50Hz	0		High Starting Torque+	50Hz	8			
		F (50Hz Default setting)	9						
	60Hz	60Hz Saturation	1			60Hz	Low Starting Torque	A	
		50Hz Saturation	2				High Starting Torque	B	
Variable Torque Characteristic	72Hz	3		Constant-power torque (Reducer)	90Hz	C			
		50Hz	Variable Torque 1			4		120Hz	D
	Variable Torque 2		5			180Hz	E		
	60Hz	Variable Torque 3	6				60Hz	Variable Torque 4	7

Table 4.4.6: 1 - 2HP V/F curve selection (220V)

Type	Specification	01-00	V/F curve	Type	Specification	01-00	V/F curve	
General application	50Hz	0		High Starting Torque+	Low Starting Torque	8		
		F (50Hz Default setting)	High Starting Torque		9			
	60Hz Saturation	1			Low Starting Torque	A		
		F (60Hz Default setting)	2			Low Starting Torque	B	
Variable Torque Characteristic	72Hz	3		Constant-power torque (Reducer)	90Hz	C		
	50Hz	Variable Torque 1	4			120Hz	D	
		Variable Torque 2	5			180Hz	E	
	60Hz	Variable Torque 3	6					
		Variable Torque 4	7					

Table 4.4.7: 3 - 30HP V/F curve selection (220V)

Type	Specification	01-00	V/F curve	Type	Specification	01-00	V/F curve	
General application	50Hz	0		High Starting Torque†	Low Starting Torque	8		
		F ( 50Hz Default setting )			High Starting Torque	9		
	60Hz	1		High Starting Torque†	Low Starting Torque	A		
		F ( 60Hz Default setting )			Low Starting Torque	B		
Variable Torque Characteristic	72Hz	3		Constant-power torque (Reducer)	90Hz	C		
	50Hz	Variable Torque 1	4			120Hz	D	
		Variable Torque 2	5			180Hz	E	
	60Hz	Variable Torque 3	6			90Hz	C	
		Variable Torque 4	7			120Hz	D	
	60Hz	Variable Torque 4	7			180Hz	E	

**Table 4.4.8: 40HP and above V/F curve selection (220V)**

Type	Specification	01-00	V/F curve	Type	Specification	01-00	V/F curve	
General application	50Hz	0		High Starting Torque†	Low Starting Torque	8		
		F (50Hz Default setting)			High Starting Torque	9		
	60Hz	1		Low Starting Torque	A			
		F (60Hz Default setting)		Low Starting Torque	B			
Variable Torque Characteristic	72Hz	3		Constant-power torque (Reducer)	90Hz	C		
	50Hz	Variable Torque 1	4			120Hz	D	
		Variable Torque 2	5					
	60Hz	Variable Torque 3	6			180Hz	E	
Variable Torque 4		7						



Table 4.4.9: 1 - 2HP V/F curve selection (230V)

Type	Specification	01-00	V/F curve	Type	Specification	01-00	V/F curve	
General application	50Hz	0		High Starting Torque†	Low Starting Torque	8		
		F ( 50Hz Default setting )			High Starting Torque	9		
	60Hz	60Hz Saturati on	1 F ( 60Hz Default setting )			Low Starting Torque	A	
		50Hz Saturati on	2			Low Starting Torque	B	
Variable Torque Characteristic	72Hz	3		Constant-power torque (Reducer)	90Hz	C		
	50Hz	Variable Torque 1	4			120Hz	D	
		Variable Torque 2	5			180Hz	E	
	60Hz	Variable Torque 3	6					
		Variable Torque 4	7					

Table 4.4.10 : 3 - 30HP V/F curve selection (230V)

Type	Specification	01-00	V/F curve	Type	Specification	01-00	V/F curve	
General application	50Hz	0		High Starting Torque†	50Hz	8		
		F (50Hz Default setting)	9					
	60Hz	1			60Hz	Low Starting Torque	A	
		F (60Hz Default setting)	2				Low Starting Torque	B
Variable Torque Characteristic	72Hz	3		Constant-power torque (Reducer)	90Hz	C		
	50Hz	Variable Torque 1	4			120Hz	D	
		Variable Torque 2	5					
	60Hz	Variable Torque 3	6			180Hz	E	
		Variable Torque 4	7					

Table 4.4.11: 40HP and above V/F curve selection (230V)

Type	Specification	01-00	V/F curve	Type	Specification	01-00	V/F curve	
General application	50Hz	0		High Starting Torque†	Low Starting Torque	8		
		F ( 50Hz Default setting )			High Starting Torque	9		
	60Hz	1		High Starting Torque†	Low Starting Torque	A		
		F ( 60Hz Default setting )			Low Starting Torque	B		
Variable Torque Characteristic	72Hz	3		Constant-power torque (Reducer)	90Hz	C		
	50Hz	Variable Torque 1	4			120Hz	D	
		Variable Torque 2	5					
	60Hz	Variable Torque 3	6			180Hz	E	
Variable Torque 4		7						

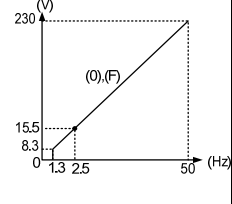
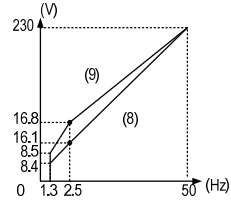
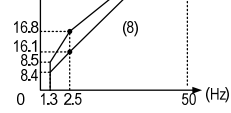
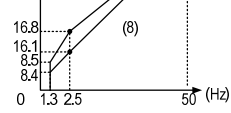
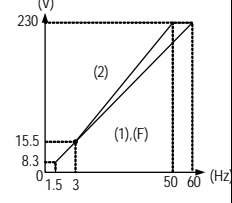
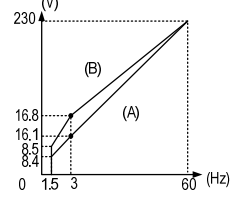
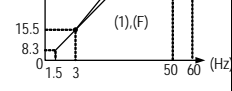
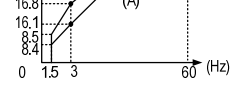
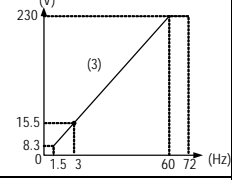
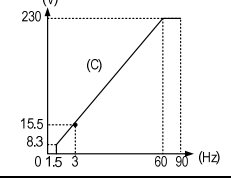
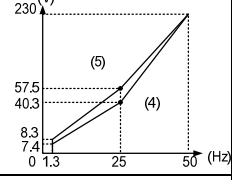
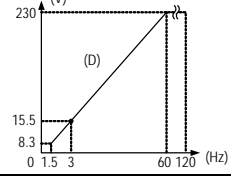
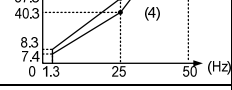
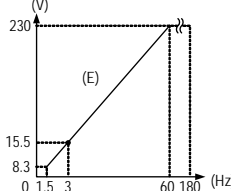
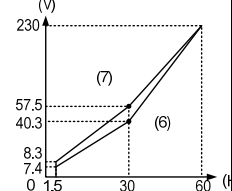
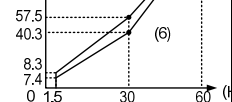
Table 4.4.12:1 - 2HP V/F curve selection (380V)



Type	Specification	01-00	V/F curve	Type	Specification	01-00	V/F curve	
General application	50Hz	0		High Starting Torque <sup>+</sup>	50Hz	8		
		F ( 50Hz Default setting )				9		
	60Hz	1			60Hz	Low Starting Torque	A	
		F ( 60Hz Default setting )				Low Starting Torque	B	
Variable Torque Characteristic	72Hz	3		Constant-power torque (Reducer)	90Hz	C		
		50Hz	Variable Torque 1			4		120Hz
	Variable Torque 2		5			180Hz	E	
	60Hz	Variable Torque 3	6				180Hz	E
		Variable Torque 4	7					

Table 4.4.13: 3 - 30HP V/F curve selection (380V)

Type	Specification	01-00	V/F curve	Type	Specification	01-00	V/F curve	
General application	50Hz	0		High Starting Torque†	Low Starting Torque	8		
		F (50Hz Default setting)	High Starting Torque		9			
	60Hz	1			Low Starting Torque	A		
		F (60Hz Default setting)	2			Low Starting Torque	B	
Variable Torque Characteristic	72Hz	3		Constant-power torque (Reducer)	90Hz	C		
	50Hz	Variable Torque 1	4			120Hz	D	
		Variable Torque 2	5					
	60Hz	Variable Torque 3	6			180Hz	E	
		Variable Torque 4	7					

Table 4.4.14: 40HP and above V/F curve selection (380V)

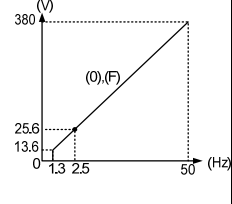
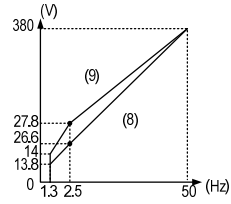
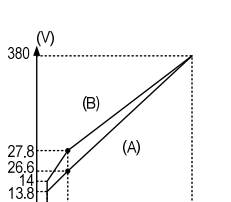
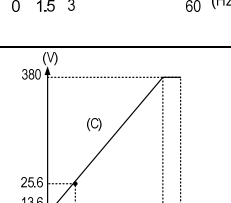
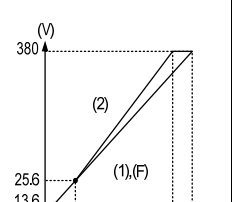
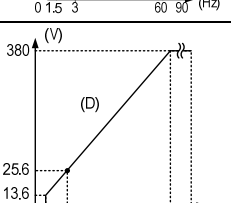
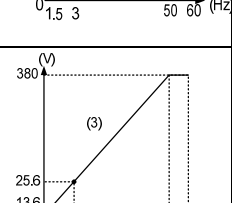
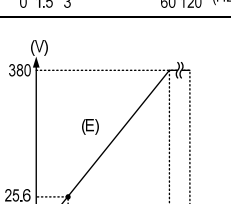
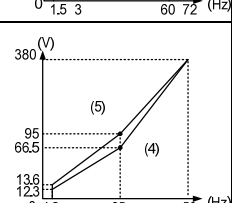
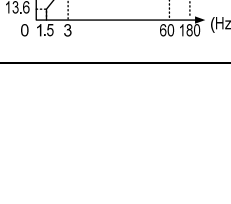
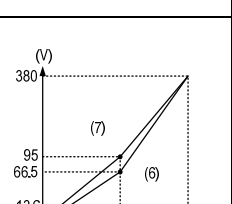
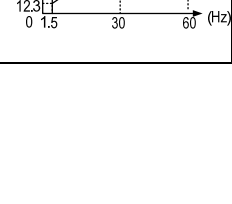
Type	Specification	01-00	V/F curve	Type	Specification	01-00	V/F curve	
General application	50Hz	0		High Starting Torque†	Low Starting Torque	8		
		F ( 50Hz Default setting )	High Starting Torque		9			
	60Hz	1			Low Starting Torque	A		
		F ( 60Hz Default setting )	2			Low Starting Torque	B	
Variable Torque Characteristic	72Hz	3		Constant-power torque (Reducer)	90Hz	C		
	50Hz	Variable Torque 1	4			120Hz	D	
		Variable Torque 2	5					
	60Hz	Variable Torque 3	6			180Hz	E	
		Variable Torque 4	7					

Table 4.4.15: 1 - 2HP V/F curve selection (400V)

Type	Specification	01-00	V/F curve	Type	Specification	01-00	V/F curve	
General application	50Hz	0		High Starting Torque+	50Hz	8		
		F (50Hz Default setting)				9		
	60Hz	1			60Hz	Low Starting Torque	A	
		F (60Hz Default setting)				High Starting Torque	B	
Variable Torque Characteristic	72Hz	3		Constant-power torque (Reducer)	90Hz	C		
		4				120Hz	D	
	5		180Hz		E			
	60Hz	6						
		7						

Table 4.4.16: 3 - 30HP V/F curve selection (400V)

Type	Specification	01-00	V/F curve	Type	Specification	01-00	V/F curve	
General application	50Hz	0		High Starting Torque†	Low Starting Torque	8		
		F ( 50Hz Default setting )			High Starting Torque	9		
	60Hz	1		High Starting Torque†	Low Starting Torque	A		
		F ( 60Hz Default setting )			Low Starting Torque	B		
Variable Torque Characteristic	72Hz	3		Constant-power torque (Reducer)	90Hz	C		
	50Hz	Variable Torque 1	4			120Hz	D	
		Variable Torque 2	5				180Hz	E
	60Hz	Variable Torque 3	6					
Variable Torque 4		7						

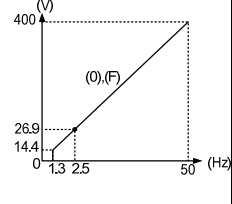
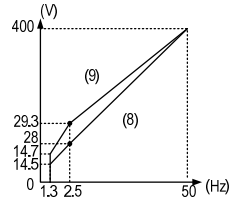
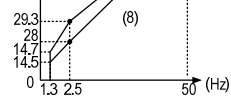
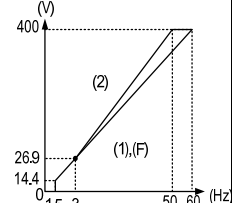
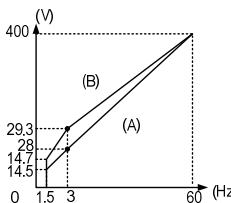
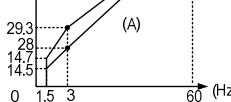
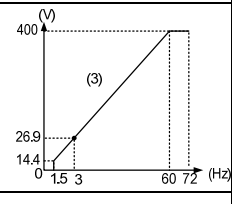
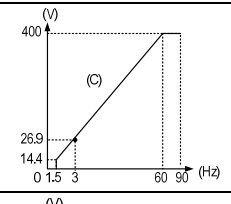
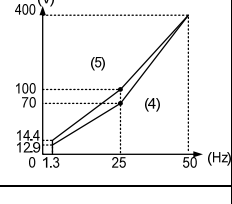
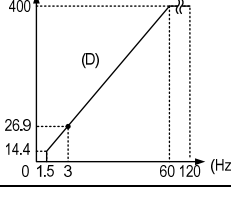
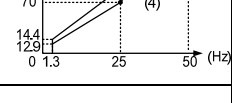
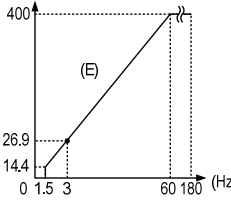
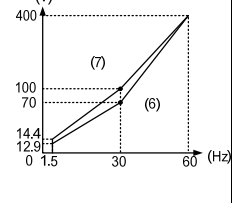
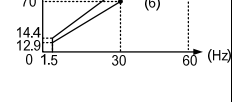

Table 4.4.17: 40HP and above V/F curve selection (400V)

Type	Specification	01-00	V/F curve	Type	Specification	01-00	V/F curve	
General application	50Hz	0		High Starting Torque†	Low Starting Torque	8		
		F (50Hz Default setting)	High Starting Torque		9			
	60Hz	1			Low Starting Torque	A		
		60Hz Saturation	F (60Hz Default setting)		High Starting Torque	9		
60Hz	50Hz Saturation	2		Low Starting Torque	B			
	Variable Torque Characteristic	72Hz	3		Constant-power torque (Reducer)	90Hz	C	
50Hz		Variable Torque 1	4			120Hz	D	
		Variable Torque 2	5			180Hz	E	
60Hz		Variable Torque 3	6					
	Variable Torque 4	7						

Table 4.4.18: 1 - 2HP V/F curve selection (415V)

Type	Specification	01-00	V/F curve	Type	Specification	01-00	V/F curve	
General application	50Hz	0		High Starting Torque <sup>+</sup>	Low Starting Torque	8		
		F ( 50Hz Default setting )			High Starting Torque	9		
	60Hz	60Hz Saturation	1 F ( 60Hz Default setting )			Low Starting Torque	A	
		50Hz Saturation	2			Low Starting Torque	B	
Variable Torque Characteristic	72Hz	3		Constant-power torque (Reducer)	90Hz	C		
	50Hz	Variable Torque 1	4			120Hz	D	
		Variable Torque 2	5					
	60Hz	Variable Torque 3	6			180Hz	E	
		Variable Torque 4	7					

Table 4.4.19: 3 - 30HP V/F curve selection (415V)

Type	Specification	01-00	V/F curve	Type	Specification	01-00	V/F curve
General application	50Hz	0		High Starting Torque†	Low Starting Torque	8	
		F (50Hz Default setting)	High Starting Torque		9		
	60Hz	1			Low Starting Torque	A	
		F (60Hz Default setting)	2			Low Starting Torque	B
Variable Torque Characteristic	72Hz	3		Constant-power torque (Reducer)	90Hz	C	
	50Hz	Variable Torque 1	4		120Hz	D	
		Variable Torque 2	5				
	60Hz	Variable Torque 3	6		180Hz	E	
Variable Torque 4		7					

Table 4.4.20 : 40HP and above V/F curve selection (415V)

Type	Specification	01-00	V/F curve	Type	Specification	01-00	V/F curve	
General application	50Hz	0		High Starting Torque†	50Hz	8		
		F (50Hz Default setting)	9					
	60Hz	1			60Hz	Low Starting Torque	A	
		F (60Hz Default setting)	2				Low Starting Torque	B
Variable Torque Characteristic	72Hz	3		Constant-power torque (Reducer)	90Hz	C		
	50Hz	Variable Torque 1	4			120Hz	D	
		Variable Torque 2	5					
	60Hz	Variable Torque 3	6			180Hz	E	
		Variable Torque 4	7					

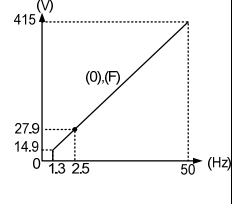
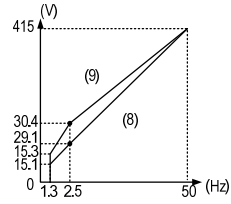
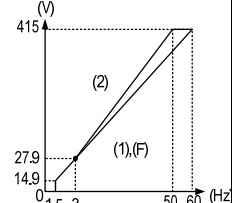
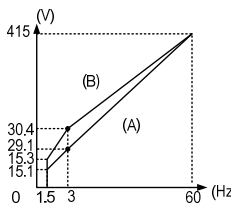
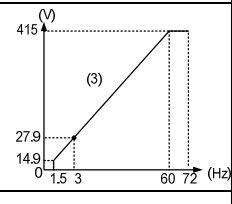
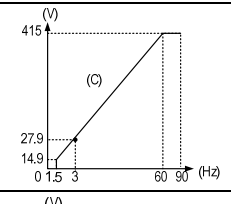
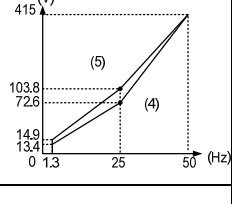
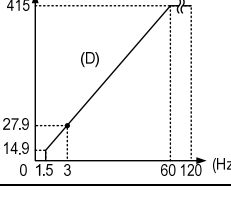
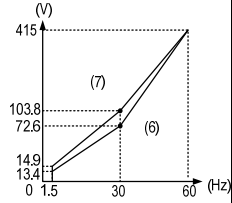
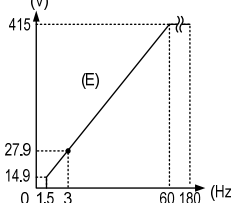
Table 4.4.21: 1 - 2HP V/F curve selection (440V)





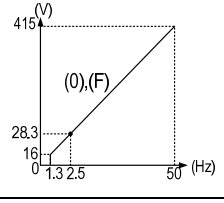
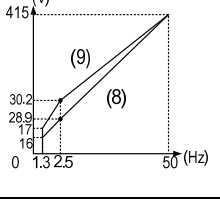
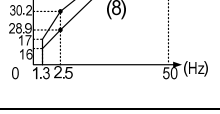
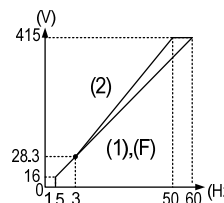
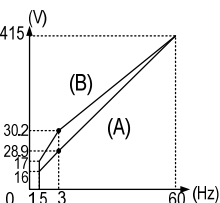
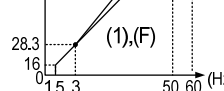
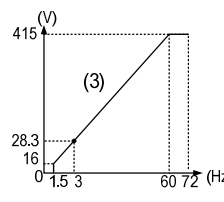
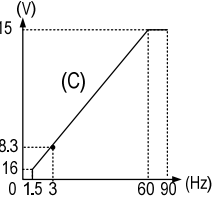
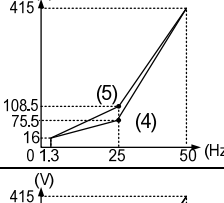
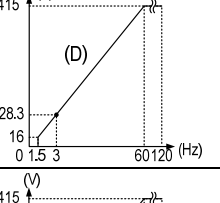
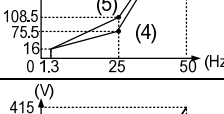
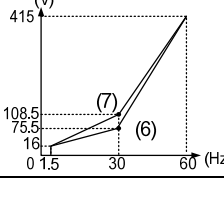
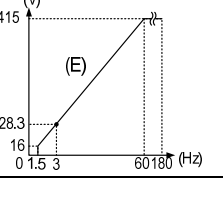
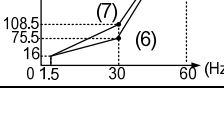

Type	Specification	01-00	V/F curve	Type	Specification	01-00	V/F curve	
General application	50Hz	0		High Starting Torque <sup>+</sup>	Low Starting Torque	8		
		F ( 50Hz Default setting )			High Starting Torque	9		
	60Hz	60Hz Saturation	1 F ( 60Hz Default setting )			Low Starting Torque	A	
		50Hz Saturation	2			Low Starting Torque	B	
Variable Torque Characteristic	72Hz	3		Constant-power torque (Reducer)	90Hz	C		
	50Hz	Variable Torque 1	4			120Hz	D	
		Variable Torque 2	5			180Hz	E	
	60Hz	Variable Torque 3	6					
		Variable Torque 4	7					

Table 4.4.22: 3 - 30HP V/F curve selection (440V)

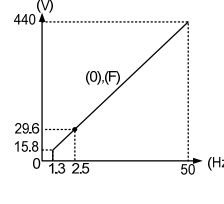
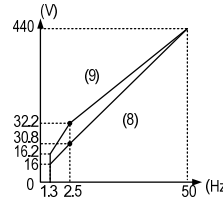
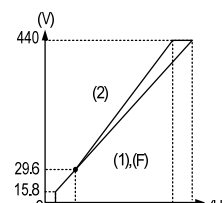
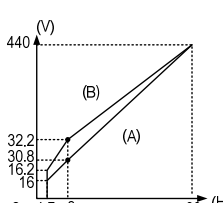
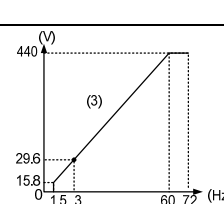
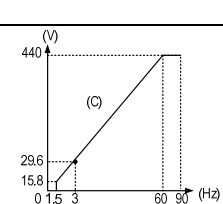
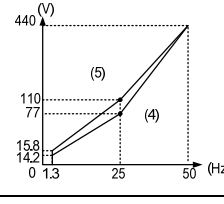
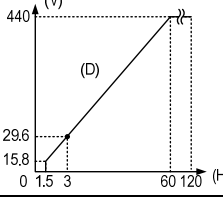
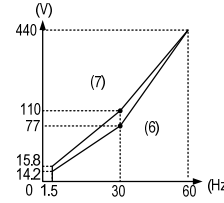
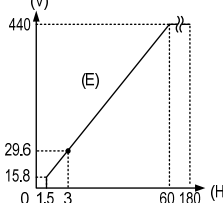
Type	Specification	01-00	V/F curve	Type	Specification	01-00	V/F curve	
General application	50Hz	0		High Starting Torque†	Low Starting Torque	8		
		F ( 50Hz Default setting )			High Starting Torque	9		
	60Hz	1			Low Starting Torque	A		
		F ( 60Hz Default setting )			Low Starting Torque	B		
Variable Torque Characteristic	72Hz	3		Constant-power torque (Reducer)	90Hz	C		
	50Hz	Variable Torque 1	4			120Hz	D	
		Variable Torque 2	5			180Hz	E	
	60Hz	Variable Torque 3	6					
		Variable Torque 4	7					

Table 4.4.23: 40HP and above V/F curve selection (440V)

Type	Specification	01-00	V/F curve	Type	Specification	01-00	V/F curve	
General application	50Hz	0		High Starting Torque†	Low Starting Torque	8		
		F ( 50Hz Default setting )			High Starting Torque	9		
	60Hz	1			Low Starting Torque	A		
		F ( 60Hz Default setting )			Low Starting Torque	B		
	50Hz Saturati on	2						
Variable Torque Characteristic	72Hz	3		Constant-power torque (Reducer)	90Hz	C		
	50Hz	Variable Torque 1	4			120Hz	D	
		Variable Torque 2	5					
	60Hz	Variable Torque 3	6			180Hz	E	
		Variable Torque 4	7					

Table 4.4.24: 1 - 2HP V/F curve selection (460V)

Type	Specification	01-00	V/F curve	Type	Specification	01-00	V/F curve		
General application	50Hz	0		High Starting Torque†	50Hz	8			
		F (50Hz Default setting)				9			
	60Hz	60Hz Saturation	1 F (60Hz Default setting)			60Hz	Low Starting Torque	A	
		50Hz Saturation	2				Low Starting Torque	B	
Variable Torque Characteristic	72Hz		3		Constant-power torque (Reducer)	90Hz		C	
	50Hz	Variable Torque 1	4			120Hz		D	
		Variable Torque 2	5			180Hz		E	
	60Hz	Variable Torque 3	6						
		Variable Torque 4	7						



Table 4.4.25: 3 - 30HP V/F curve selection (460V)

Type	Specification	01-00	V/F curve	Type	Specification	01-00	V/F curve
General application	50Hz	0		High Starting Torque†	Low Starting Torque	8	
		F ( 50Hz Default setting )	High Starting Torque		9		
	60Hz	1			Low Starting Torque	A	
		F ( 60Hz Default setting )	2			Low Starting Torque	B
Variable Torque Characteristic	72Hz	3		Constant-power torque (Reducer)	90Hz	C	
	50Hz	Variable Torque 1	4		120Hz	D	
		Variable Torque 2	5				
	60Hz	Variable Torque 3	6		180Hz	E	
Variable Torque 4		7					

Table 4.4.26: 40HP and above V/F curve selection (460V)

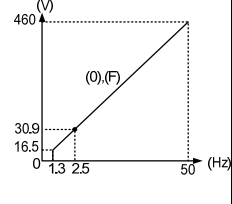
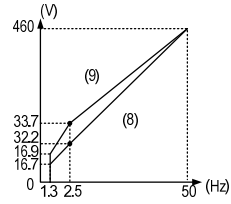
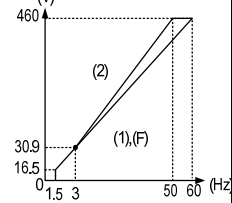
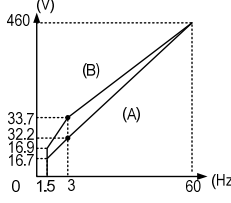
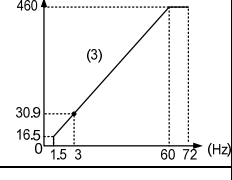
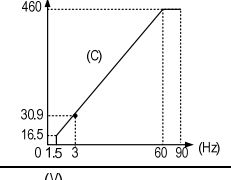
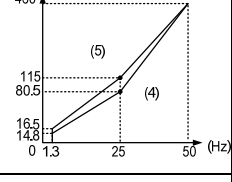
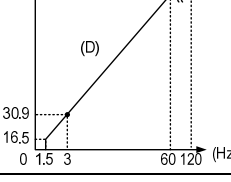
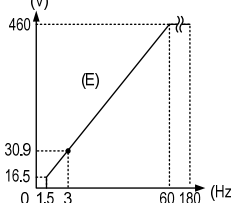
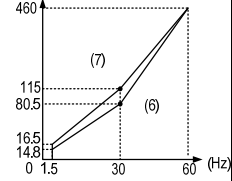
Type	Specification	01-00	V/F curve	Type	Specification	01-00	V/F curve	
General application	50Hz	0		High Starting Torque†	Low Starting Torque	8		
		F ( 50Hz Default setting )			High Starting Torque	9		
	60Hz	1			Low Starting Torque	A		
		F ( 60Hz Default setting )			Low Starting Torque	B		
Variable Torque Characteristic	72Hz	3		Constant-power torque (Reducer)	90Hz	C		
	50Hz	Variable Torque 1	4			120Hz	D	
		Variable Torque 2	5			180Hz	E	
	60Hz	Variable Torque 3	6					
Variable Torque 4		7						

<b>01-02</b>	<b>Maximum output frequency of motor 1</b>
<b>Range</b>	4.8~599.0 Hz
<b>01-03</b>	<b>Maximum output voltage of motor 1</b>
<b>Range</b>	200V: 0.1~255.0 V 400V: 0.2~510.0 V 575V: 0.1~670.0 V 690V: 0.1~804.0 V
<b>01-04</b>	<b>Middle output frequency 2 of motor 1</b>
<b>Range</b>	0.0~599.0 Hz
<b>01-05</b>	<b>Middle output voltage 2 of motor 1</b>
<b>Range</b>	200V: 0.0~255.0 V 400V: 0.0~510.0 V 575V: 0.0~670.0 V 690V: 0.0~804.0 V
<b>01-06</b>	<b>Middle output frequency 1 of motor 1</b>
<b>Range</b>	0.0~599.0 Hz
<b>01-07</b>	<b>Middle output voltage 1 of motor 1</b>
<b>Range</b>	200V: 0.0~255.0 V 400V: 0.0~510.0 V 575V: 0.0~670.0 V 690V: 0.0~804.0 V
<b>01-08</b>	<b>Minimum output frequency of motor 1</b>
<b>Range</b>	0.0~599.0 Hz
<b>01-09</b>	<b>Minimum output voltage of the motor 1</b>
<b>Range</b>	200V: 0.0~255.0 V 400V: 0.0~510.0 V 575V: 0.0~670.0 V 690V: 0.0~804.0 V
<b>01-12</b>	<b>Base frequency of motor 1</b>
<b>Range</b>	4.8~599.0 Hz
<b>01-13</b>	<b>Base output voltage of motor 1</b>
<b>Range</b>	200V: 0.0~255.0 V 400V: 0.0~510.0 V 575V: 0.0~670.0 V 690V: 0.0~804.0 V

### V/F curve setting (01-02~01-09 and 01-12~01-13)

Select any of the predefined V/F curves setting '0' to 'E' that best matches your application and the load characteristic of your motor, choose a custom curve setting 'F' or 'FF' to set a custom curve.

#### Important:

Improper V/F curve selection can result in low motor torque or increased current due to excitation.

For low torque or high speed applications, the motor may overheat. Make sure to provide adequate cooling when operating the motor under these conditions for a longer period of time.

If the automatic torque boost function is enabled (parameter 01-10), the applied motor voltage will automatically change to provide adequate motor torque during start or operating at low frequency.

#### Custom V/F Curve Setting:

A custom curve selection allows users to set parameters 01-02 ~ 01-13 whereas a predefined curve selection does not.

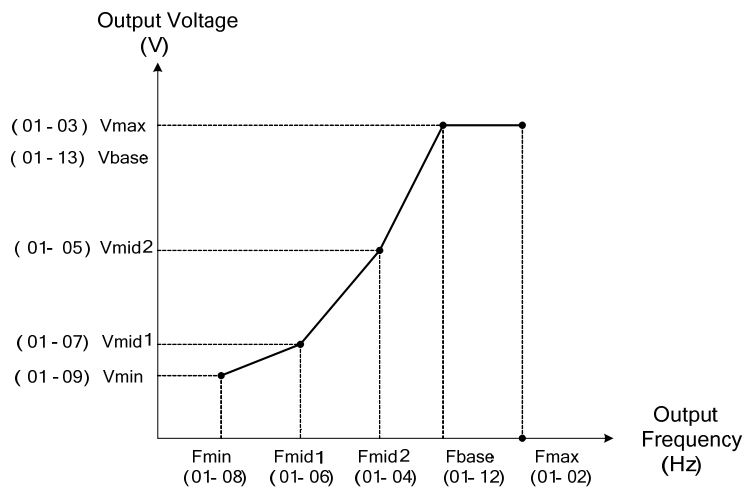

Figure 4.4.12 Custom V/F curve

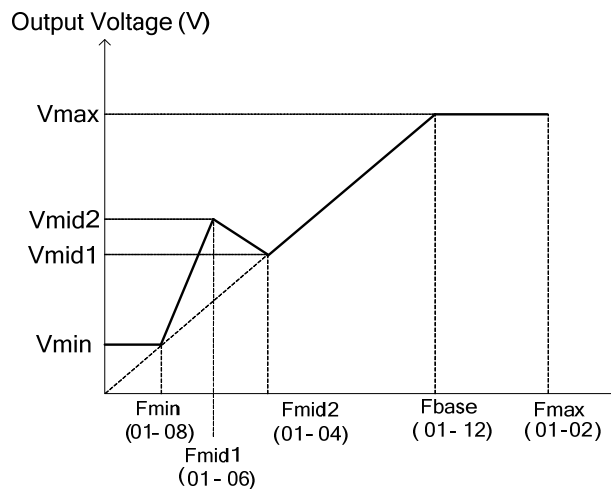

Figure 4.4.13 Torque boosting

When setting the frequency related parameters for a custom V/F curve values make sure that:

$$\begin{matrix} F_{\max} & \geq & F_{\text{base}} & > & F_{\text{mid2}} & > & F_{\text{mid1}} & > & F_{\min} \\ (01-02) & & (01-12) & & (01-04) & & (01-06) & & (01-08) \end{matrix}$$

The 'SE03' V/F curve tuning error is displayed when the frequency values are set incorrectly.

When 01-04 and 01-05 (or 01-18 and 01-19) are set to 0, the inverter ignores the set values of Fmid2 and Vmid2.

The voltage values for 01-02~01-09 are irrelevant.

The value for maximum output voltage of motor 1(01-03) and the value for base output voltage of motor 1(01-13) will depend on restore factory setting(13-08) to set the value of voltage.

When the control mode is changed parameter 00-00, 01-08 ( $F_{\min}$ ) and 01-09 ( $V_{\min}$ ) will automatically be changed to the default setting of the selected control mode.

### **SLV or SV Mode (Sensorless Vector or Sensor Vector Control)**

Enter the motor data in parameter group 17 for SV and SLV control mode (00-00) and perform auto-tuning.

In the SV and SLV mode the V/F curve normally does not have to be re-adjusted after a successful auto-tune.

The maximum output frequency setting 01-02 ( $F_{\max}$ ), base frequency 01-12 ( $F_{\text{base}}$ ), minimum output frequency 01-08 ( $F_{\min}$ ), maximum output voltage 01-03 ( $V_{\max}$ ) or base output voltage 01-13 ( $V_{\text{base}}$ ) can be adjusted but the voltage is automatically adjusted by the internal current controller.

Set the base frequency (01-12,  $F_{\text{base}}$ ) to the motor rated frequency on the motor nameplate.

Perform the auto-tuning procedure after adjusting parameters 02-19 or 17-04 to reduce the voltage at no-load operation.

Motor jitter can be reduced by lowering the no-load voltage. Please note that lowering the no-load voltage increases the current at no-load.

**\* The setting of V/F curve in SLV2 is the same as that in VF mode.**

<b>01-10</b>	<b>Torque compensation gain</b>
<b>Range</b>	0.0~2.0

In V/F or V/F + PG and SLV2 mode the inverter automatically adjusts the output voltage to adjust the output torque during start or during load changes based on the calculated loss of motor voltage.

Torque compensation gain (01-10) can adjust in the running time. No need to adjust in general except the following:

- If the wire between inverter and motor is too long, add the value of 01-10
- If the capacity of motor is smaller than inverter, add the value of 01-10.
- If the motor vibrates, reduce the value of 01-10

Refer to the torque compensation gain adjustment shown in Figure 4.4.14.

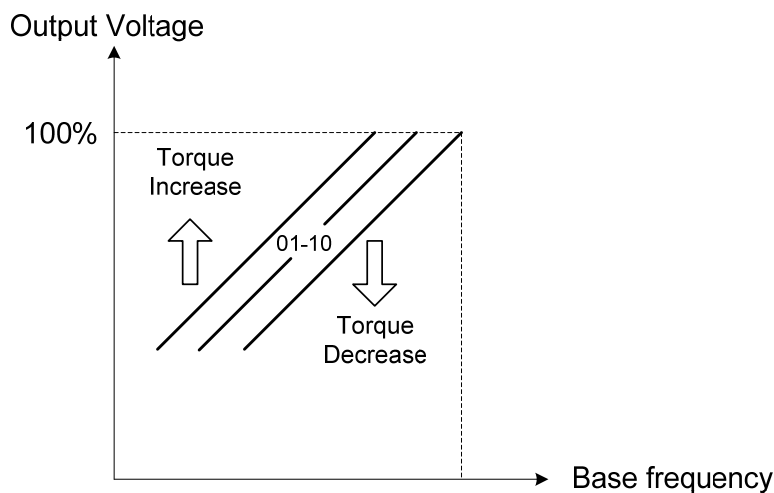

**Figure 4.4.14 Torque compensation gain to increase/decrease output torque**

Increase value when:

- The wiring between the inverter and the motor very too long
- The motor size is smaller than the inverter size

**Note:** Gradually increase the torque compensation value and make sure the output current does not exceed inverter rated current.

Reduce value when:

- When experiencing motor vibration

**Important:**

Confirm that the output current at low speed does not exceed the rated output current of the inverter.

<b>01-11</b>	<b>Selection of Torque Compensation Mode</b>
<b>Range</b>	0: Torque Compensation Mode 0 1: Torque Compensation Mode 1

Torque compensation mode 0 is the general mode.

Torque Compensation Mode 1 is the high speed mode (120~160Hz) and the compensation amount decreases as

the increasing frequency. When the speed is at 0~120Hz, the compensation amount is the same as that in Torque compensation mode 0.

<b>01-14</b>	<b>Input voltage setting</b>
<b>Range</b>	<b>200V:</b> 155.0~255.0 V <b>400V:</b> 310.0~510.0 V <b>575V:</b> 540.0~670.0 V <b>690V:</b> 648.0~804.0 V

The minimum input voltage of inverter is 0.1V.

Set the inverter input voltage (E.g. 200V / 208V / 230V / 240V or 380V / 415V / 440V / 460V / 480V).

This parameter is used as a reference for predefined V/F curve calculation (01-00 = 0 to E), over-voltage protection level, stall prevention, etc...

**Note:** It will depend on restore factory setting (13-08) to set the value of voltage

<b>01-15</b>	<b>Torque compensation time</b>
<b>Range</b>	0~10000 ms

Set the torque compensation delay time in milliseconds.

Only adjust in the following situations:

Increase value when:

- When experiencing motor vibration

Decrease value when:

- When motor torque response is too slow

<b>01-16</b>	<b>Maximum output frequency of motor 2</b>
<b>Range</b>	4.8~599.0 Hz

<b>01-17</b>	<b>Maximum output voltage of motor 2</b>
<b>Range</b>	<b>200V:</b> .1~255.0 V <b>400V:</b> .2~510.0 V <b>575V:</b> 0.1~670.0 V <b>690V:</b> 0.1~804.0 V

<b>01-18</b>	<b>Middle output frequency 2 of motor 2</b>
<b>Range</b>	0.0~599.0 Hz

<b>01-19</b>	<b>Middle output voltage 2 of motor 2</b>
<b>Range</b>	<b>200V:</b> 0.0~255.0 V <b>400V:</b> 0.0~510.0 V <b>575V:</b> 0.0~670.0 V <b>690V:</b> 0.0~804.0 V

<b>01-20</b>	<b>Middle output frequency 1 of motor 2</b>
<b>Range</b>	0.0~599.0 Hz

<b>01- 21</b>	<b>Middle output voltage 1 of motor 2</b>
<b>Range</b>	<b>200V:</b> 0.0~255.0 V <b>400V:</b> 0.0~510.0 V <b>575V:</b> 0.0~670.0 V <b>690V:</b> 0.0~804.0 V

<b>01- 22</b>	<b>Minimum output frequency of motor 2</b>
<b>Range</b>	0.0~599.0 Hz

<b>01-23</b>	<b>Minimum output voltage of motor 2</b>
<b>Range</b>	<b>200V:</b> 0.0~255.0 V <b>400V:</b> 0.0~510.0 V <b>575V:</b> 0.0~670.0 V <b>690V:</b> 0.0~804.0 V

<b>01- 24</b>	<b>Base frequency of motor 2</b>
<b>Range</b>	4.8~599.0 Hz

<b>01- 25</b>	<b>Base voltage of motor 2</b>
<b>Range</b>	<b>200V:</b> 0.0~255.0 V <b>400V:</b> 0.0~510.0 V <b>575V:</b> 0.0~670.0 V <b>690V:</b> 0.0~804.0 V

<b>01- 26</b>	<b>V/F Curve Selection of Motor 2</b>
<b>Range</b>	0~FF

**Note:** Motor 2 V/F curve uses the same settings as motor 1.

**Note:** Motor 2 V/F curve is the same as Motor 1, please refer to Table 4.4.3~26



## 02 - IM Motor Parameters

<b>02- 00</b>	<b>No-load current of motor 1</b>
<b>Range</b>	0.01~600.00 A
<b>02- 01</b>	<b>Rated current of motor 1</b>
<b>Range</b>	V/F and V/F+PG modes are 10%~200% of inverter's rated current. SLV, SV modes are 25%~200% of inverter's rated current.
<b>02-03</b>	<b>Rated rotation speed of motor1</b>
<b>Range</b>	0~60000 rpm
<b>02- 04</b>	<b>Rated voltage of motor1</b>
<b>Range</b>	200V: 50.0~240.0 V 400V: 100.0~480.0 V 575V: 150.0~670.0 V 690V: 200.0~804.0 V
<b>02- 05</b>	<b>Rated power of motor 1</b>
<b>Range</b>	0.01~600.00 KW
<b>02-06</b>	<b>Rated frequency of motor 1</b>
<b>Range</b>	4.8~599.0 Hz+
<b>02-07</b>	<b>Pole of motor 1</b>
<b>Range</b>	2~16
<b>02-09</b>	<b>Excitation current of motor 1 &lt;1&gt;</b>
<b>Range</b>	15.0~70.0 %
<b>02-10</b>	<b>Core saturation coefficient 1 of motor 1 &lt;1&gt;</b>
<b>Range</b>	1~100 %
<b>02-11</b>	<b>Core saturation coefficient 2 of motor 1 &lt;1&gt;</b>
<b>Range</b>	1~100 %
<b>02-12</b>	<b>Core saturation coefficient 3 of motor 1 &lt;1&gt;</b>
<b>Range</b>	80~300 %
<b>02-13</b>	<b>Core loss of motor 1</b>
<b>Range</b>	0.0~15.0 %
<b>02-15</b>	<b>Resistance between wires of motor 1</b>
<b>Range</b>	0.001~60.000 Ω

02-19	No-Load Voltage of motor 1
Range	200V: 50~240 V 400V: 100~480 V 575V: 420~600 V 690V: 504~720 V

Motor parameters are automatically set when performing an auto-tune (17-10=1). In most case no adjustment is required after performing an auto-tune except when using the inverter in special applications (e.g. machine tool, positioning, etc...).

Please refer to parameter group 22 for permanent magnet motor parameters.

(1) Number of motor poles (02-07)

Set the number of motor pole according to the motor nameplate.

(2) Motor rated power (02-05)

Set the motor power according to the motor nameplate.

(3) Motor rated current (02-01)

Set the motor rated current according to the motor nameplate.

(4) Motor rated voltage (02-04)

Set the motor rated voltage according to the motor nameplate.

Set the motor rated voltage and it will adjust maximum output voltage of V/F curve.

(5) Rated frequency of motor 1 (02-06)

Set the motor rated frequency according to the motor nameplate.

(6) Rated rotation speed of motor 1 (02-03)

Set the motor rpm according to the motor nameplate.

(7) No-load motor voltage (02-19)

Parameter determines the rated flux during motor's rated rotation in SLV or SV control mode. Set the value of this parameter to the same value as parameter 17-08. A value of 10~50V below the input voltage level ensures that the motor is capable of providing adequate torque performance when operating at nominal speed (or higher speed). Setting the value to small can result in a reduction in no-load current, weakened motor flux and an increase in motor current while the motor is loaded.

(8) Motor excitation current (02-09)

The current is obtained from rotational auto-tuning. It is required to perform manual tuning if the inverter cannot rotational auto-tune.

When the manual tuning is performed, tune it from 33% and observe no-load voltage (the output value) of parameter 12-67. If parameter 12-67 is higher than no-load voltage (the setting value) of parameter 17-08, perform downward revision in parameter 02-09; if it is lower than that, perform upward revision in parameter 02-09.

Tuning motor excitation current of parameter 02-09 will change motor leakage inductance of parameter 02-17 and motor mutual inductance of parameter 02-18.

It is required to refer to the actual no-load voltage of parameter 12-76 to tune the motor excitation current of parameter 02-09. Change of the excitation current will also affect the relative actual no-load voltage fluctuation so it is required to tune to the similar setting value of no-load voltage (17-08). 1

(9) Setting of motor core's saturation coefficient 1, 2 and 3 (02-10, 02-11, 02-12)

These parameters are automatically set during auto-tune. No adjustment required. Parameters are set to 50% for 02-10, 75% for 02-11 and 137.5% for 02-12 to reduce the impact of core saturation. The motor core's saturation coefficient is defined as a percentage of the motor excitation current. When the motor flux reaches 137.5% level, the core's saturation coefficient shall be greater than 137.5%. When the motor flux is 50% or 75%, the core's saturation coefficient is required to be less than 50% and 75%.

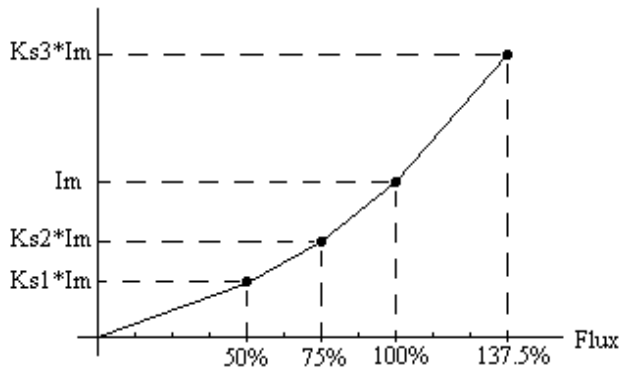

Im : 02-09 Excitation Current  
 Ks1: 02-10 Motor Core Saturation Coefficients 1  
 Ks2: 02-11 Motor Core Saturation Coefficients 2  
 Ks3: 02-12 Motor Core Saturation Coefficients 3

(10) Motor core loss (02-13)

Set motor core loss as the percentage of the motor rated power.

$$\% W_{\text{core}} (02-13) = \frac{3 \times \text{Motor core loss (watt)}}{\text{Motor rated power (watts, 02-05)}} \times 100\%$$

**Note:** In V/F mode motor core loss (02-13) is used to for torque compensation.

(11) Motor line to line resistance (02-15)

(12) Motor no-load current (02-00).

Value is calculated based on the motor rated frequency (17-05) and motor rated current (17-03).

In V / F control mode, the output current is greater than the no-load current with slip compensation is enabled.

**Note:** The value of 02-01 needs to be greater than the value set in parameter 02-00, otherwise warning message "SE01" out of range error will be displayed.

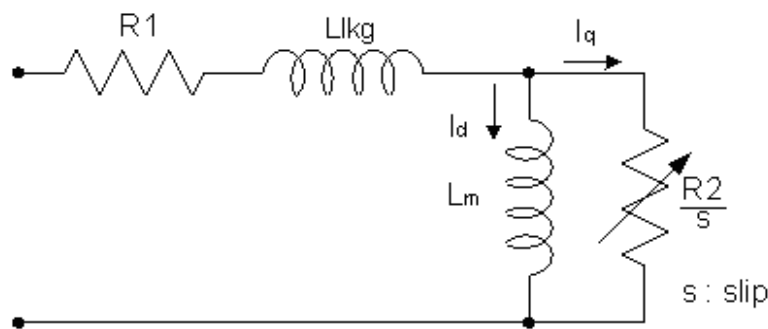

Figure 4.4.15 Y-equivalent model an induction motor

<b>02-20</b>	<b>No-Load Current of motor 2</b>
<b>Range</b>	0.01~600.00 A

<b>02-21</b>	<b>Rated current of motor 2</b>
<b>Range</b>	10%~200% of inverter's rated current

<b>02-22</b>	<b>Rated rotation speed of motor 2</b>
<b>Range</b>	0~ 60000 rpm

<b>02- 23</b>	<b>Rated voltage of motor 2</b>
<b>Range</b>	200V: 50.0~240.0 V 400V: 100.0~480.0 V 575V: 150.0~670.0 V 690V: 200.0~804.0 V

<b>02- 24</b>	<b>Rated power of motor 2</b>
<b>Range</b>	0.01~600.00 kW

<b>02-25</b>	<b>Rated frequency of motor 2</b>
<b>Range</b>	4.8~599.0 Hz

<b>02-26</b>	<b>Pole of motor 2</b>
<b>Range</b>	2~16

<b>02-32</b>	<b>Resistance between wires of motor 2</b>
<b>Range</b>	0.001~60.000 Ω

**Note:** Motor 2 V/F curve uses the same settings as motor 1. The control mode setting for motor 2 is fixed to V/F.

<b>02-33</b>	<b>Proportion of Motor 1 Leakage Inductance &lt;1&gt;</b>
<b>Range</b>	0.1~15.0 %

It is set by manual tuning function. Normally, it does not need to be adjusted because magnetic function does not exist in this adjustment.

$$\xi = \frac{LlKg}{Lr}$$

Definition of leakage inductance proportion is the ratio of leakage inductance to rotor inductance. If the default value is set to 3.4%, adjust this ratio will affect the motor leakage inductance parameter to be changed.

When the adjustment of leakage inductance proportion is larger or smaller, it will cause the motor jittering with abnormal noise and the motor cannot run. Generally, the adjusted value is 3.0%~5.0%. 4.0% is the universal adjustment value that can make the motor run normally. The adjustment of leakage inductance proportion depends on the motor rating.

<b>02-34</b>	<b>Motor 1 Slip Frequency &lt;1&gt;</b>
<b>Range</b>	0.1~20.0 Hz

Normally, it is not required to be adjusted. It can be obtained via manual tuning parameter function. Such tuning does not have magnetic function.

The default value of motor slip is set to 1 Hz. Motor slip is obtained from the nameplate.

Take 60Hz, 4-pole motor for example, synchronous speed: 
$$N = \frac{120 \times \text{Frequency}}{\text{Pole}} = \frac{120 \times 60}{4} = 1800 \text{ rpm}$$

Rated speed in the nameplate is 1700 rpm, then 
$$\text{Slip} = \frac{1800 - 1700}{60} = 1.67 \text{ Hz} \circ$$

Adjusting motor slip will change the rotor resistance parameter. The motor slip is adjusted depending on the motor performance.

<b>02-37</b>	<b>Motor Mechanical Loss</b>
<b>Range</b>	0.0~10.0 %

Adjustment range of mechanical loss is 0.0~10.0%. It is enabled only in the speed mode and the speed command being 0.

If the speed command is 0 and the shaft will be at slow drift causing to be static incompletely, adjust upwards the range of mechanical loss until the shaft is completely static.

**Note:** After executing auto-tuning, parameters which marked <1> will renew the value. Please refer Group 17: Automatic Tuning Parameters for more detail.

### 03- External Digital Input and Output Parameters

<b>03-00</b>	<b>Multi-function terminal function setting – S1</b>
<b>03-01</b>	<b>Multi-function terminal function setting – S2</b>
<b>03-02</b>	<b>Multi-function terminal function setting – S3</b>
<b>03-03</b>	<b>Multi-function terminal function setting – S4</b>
<b>03-04</b>	<b>Multi-function terminal function setting – S5</b>
<b>03-05</b>	<b>Multi-function terminal function setting – S6</b>
<b>03-06</b>	<b>Multi-function terminal function setting – S7</b>
<b>03-07</b>	<b>Multi-function terminal function setting – S8</b>
<b>Range</b>	<p> <b>0:</b> 2-Wire sequence (ON: Forward run command)  <b>1:</b> 2-Wire sequence (ON: Reverse run command)  <b>2:</b> Multi-speed/position setting command 1  <b>3:</b> Multi-speed/position setting command 2  <b>4:</b> Multi-speed/position setting command 3  <b>5:</b> Multi-speed/position setting command 4  <b>6:</b> Forward jog run command  <b>7:</b> Reverse jog run command  <b>8:</b> UP frequency increasing command  <b>9:</b> DOWN frequency decreasing command  <b>10:</b> Acceleration/deceleration time selection 1  <b>11:</b> Inhibit Acceleration/deceleration Command  <b>12:</b> Main/ Alternative Run Switch Function  <b>13:</b> Main/ Alternative Frequency Switch Function  <b>14:</b> Emergency stop (decelerate to zero and stop)  <b>15:</b> External Baseblock Command(rotation freely to stop)  <b>16:</b> PID control disable  <b>17:</b> Fault reset (RESET)  <b>18:</b> Reserved  <b>19:</b> Speed Search 1 (from the maximum frequency)  <b>20:</b> Manual energy saving function  <b>21:</b> PID integral reset  <b>22~23:</b> Reserved  <b>24:</b> PLC input  <b>25:</b> External fault  <b>26:</b> 3-Wire sequence (Forward/Reverse command)  <b>27:</b> Local/Remote selection  <b>28:</b> Remote mode selection  <b>29:</b> Jog frequency selection  <b>30:</b> Acceleration/deceleration time selection 2  <b>31:</b> Inverter overheating warning  <b>32:</b> Sync command  <b>33:</b> DC braking  <b>34:</b> Speed Search 2 (from the frequency command)  <b>35:</b> Time function input  <b>36:</b> PID Soft start disabled  <b>37:</b> Traversing operation  <b>38:</b> Upper Deviation of traverse operation  <b>39:</b> Lower Deviation of traverse operation  <b>40:</b> Switching between motor 1/motor 2 </p>

	<p><b>41:</b> PID Sleep</p> <p><b>42:</b> PG disable</p> <p><b>43:</b> PG integral reset</p> <p><b>44:</b> Mode switching between speed and torque</p> <p><b>45:</b> Negative torque command</p> <p><b>46:</b> Zero-Servo Command</p> <p><b>47:</b> Fire Mode (Forced Operation mode)</p> <p><b>48:</b> KEB acceleration</p> <p><b>49:</b> Parameter writing allowable</p> <p><b>50:</b> Unattended Start Protection (USP)</p> <p><b>51:</b> Mode switching between speed and position</p> <p><b>52:</b> Multi Position Reference Enable</p> <p><b>53:</b> 2-Wire Self Holding Mode (Stop Command)</p> <p><b>54:</b> Reserved</p> <p><b>55:</b> RTC Time Enable</p> <p><b>56:</b> RTC Offset Enable</p> <p><b>57:</b> Reserved</p> <p><b>58:</b> Safety Function</p> <p><b>59:</b> Reserved</p> <p><b>60:</b> Reserved</p> <p><b>61:</b> Reserved</p> <p><b>62:</b> EPS Function</p> <p><b>63:</b> Reserved</p> <p><b>64:</b> Reserved</p> <p><b>65:</b> Short-circuit breaking</p> <p><b>66:</b> PID Disabled 2</p> <p><b>67:</b> Manual Pulse Generator Mode Switch</p> <p><b>68:</b> External Fault 2</p> <p><b>69:</b> External Overload</p>
--	--

Refer to the multi-function digital input and related parameters in the following figure 4.4.16.

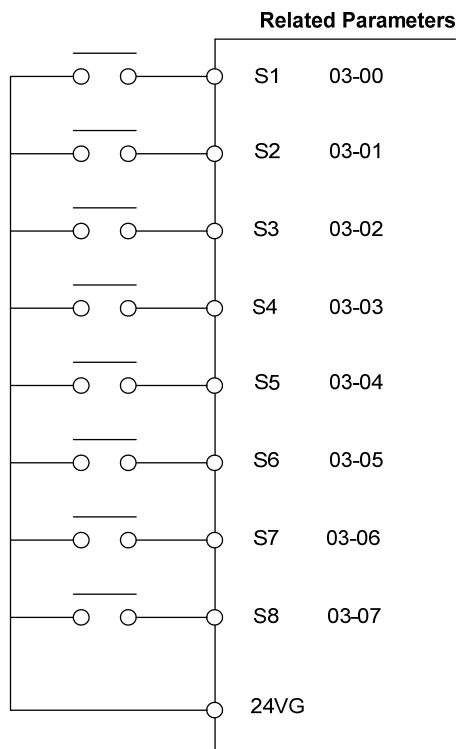

**Figure 4.4.16 Multi-function digital input and related parameters**



**Table 4.4.27 Multi-function digital input setting (03-00 to 03-07) (“O”: Enable, “X”: Disable)**

Value	Function		Description	Control mode						
	Name	LCD Display		V/F	V/F+PG	SLV	SV	PM SV	PM SLV	SLV 2
0	2-wire type (Forward operation)	2-Wire (FWD-RUN)	2- wire (ON : Forward operation command).	○	○	○	○	○	○	○
1	2-wire type (Reverse operation)	2-Wire (REV-RUN)	2- wire (ON : Reverse operation command).	○	○	○	○	○	○	○
2	Multi-speed/position setting command 1	Muti-Spd/Pos Ref 1	Multi-Speed Reference /Position Reference 1	○	○	○	○	○	○	○
3	Multi-speed/position setting command 2	Muti-Spd/Pos Ref 2	Multi-Speed Reference /Position Reference 2	○	○	○	○	○	○	○
4	Multi-speed/position setting command 3	Muti-Spd/Pos Ref 3	Multi-speed Reference /Position Reference 3	○	○	○	○	○	○	○
5	Multi-speed/position setting command 4	Muti-Spd/Pos Ref 4	Multi-speed Reference /Position Reference 4	○	○	○	○	○	○	○
6	Forward jog run command	FJOG	ON: Forward operation in jog mode (00-18).	○	○	○	○	○	○	○
7	Reverse jog run command	RJOG	ON: Reverse operation in jog mode (00-18).	○	○	○	○	○	○	○
8	UP frequency increasing command	UP command	ON: Command of output frequency increasing (only used by support of DOWN command).	○	○	○	○	○	○	○
9	DOWN frequency decreasing command	DOWN command	ON: Command of output frequency decreasing (only used by support of UP command).	○	○	○	○	○	○	○
10	Acceleration/deceleration time selection 1	Acc/Decel Time Selection 1	Acceleration/deceleration time selection command 1	○	○	○	○	○	○	○
11	Acceleration/deceleration Inhibition Command	ACC/DEC Inhibit	ON: Acceleration/ deceleration prohibition	○	○	○	○	○	○	○
12	Main/ Alternative Run Switch Function	Run Change Sel	Run Command Source is set in parameter of alternative frequency command (00-03)	○	○	○	○	○	○	○
13	Main/ Alternative Frequency Switch Function	Freq Change Sel	Frequency Command Source is set in parameter of alternative frequency command (00-06)	○	○	○	○	○	○	○
14	Emergency stop (decelerate to zero and stop)	E-Stop	ON: Emergency stop input	○	○	○	○	○	○	○
15	External baseblock command (rotation freely to stop)	Ext. BB	ON: Inverter base interdiction	○	○	○	○	○	○	○
16	PID control disabled	PID Disable	ON: PID control disabled	○	○	○	○	○	○	○
17	Fault reset	Fault Reset	Fault reset	○	○	○	○	○	○	○
18	Reserved	Reserved	Reserved	-	-	-	-	-	-	-
19	Speed Search 1 (from the maximum frequency)	Speed Search 1	ON: Search the speed from the maximum output frequency	○	○	○	○	○	X	○
20	Manual energy saving function	Energy saving	ON: Manual energy saving control is based on the settings of 11-12 and 11-18.	○	○	X	X	X	X	X

Value	Function		Description	Control mode						
	Name	LCD Display		V/F	V/F+PG	SLV	SV	PM SV	PM SLV	SLV 2
21	PID integral reset	PID I-Reset	ON: PID integral value reset	0	0	0	0	0	0	0
22	Reserved	Reserved	Reserved	-	-	-	-	-	-	-
23	Reserved	Reserved	Reserved	-	-	-	-	-	-	-
24	PLC input	PLC Input	ON: Digital PLC input	0	0	0	0	0	0	0
25	External fault	Ext. Fault	ON: External fault alarm	0	0	0	0	0	0	0
26	3-Wire sequence (Forward/Reverse command)	3-Wire (FWD/REV)	3-wire control (forward/reverse command). ON: Reverse; OFF: Forward. When the parameter is set to 26, terminal S1 and terminal will become operation command and stop command respectively, and their original functions will be closed.	0	0	0	0	0	0	0
27	Local/Remote selection	Local/Remote	ON: Local mode (via the digital operator) OFF: Frequency command and operation command will be determined according to the setting of parameter (00-02 and 00-05).	0	0	0	0	0	0	0
28	Remote mode selection	Remote Mode Sel	ON: RS-485 communication OFF: Control circuit terminal	0	0	0	0	0	0	0
29	Jog frequency Selection	JOG Freq sel	ON: Select jog frequency command	0	0	0	0	0	0	0
30	Acceleration/deceleration time selection 2	Acc/Decel Time Selection 2	Acceleration/ deceleration time selection command 2	0	0	0	0	0	0	0
31	Inverter overheating warning	Overheat Alarm	ON: Inverter overheat alarm (OH2) input ( will display OH2)	0	0	0	0	0	0	0
32	Sync command	Sync Command	ON: Synchronous speed start OFF: Synchronous speed close (Start other frequency command).	0	0	0	0	0	0	0
33	DC braking	DC Brake Command	ON: Perform DC braking	0	0	0	0	X	X	0
34	Speed Search 2 (from the frequency command)	Speed Search 2	ON: Search speed from set frequency	0	0	0	0	X	0	0
35	Time function input	Time Input	.Set the time function at 03-33, 03-34 .Set the time function output at 03-11, 03-12	0	0	0	0	0	0	0
36	PID Soft start ineffective	PID SFS Disable	ON: PID slow-start off	0	0	0	0	0	0	0
37	Traversing operation	Wobble Run	ON: Frequency wobbling operation	0	0	X	X	X	X	0
38	Upper Deviation of traverse operation	Upper Dev Run	ON: Upper offset off frequency wobbling	0	0	X	X	X	X	0

Value	Function		Description	Control mode						
	Name	LCD Display		V/F	V/F+PG	SLV	SV	PM SV	PM SLV	SLV 2
39	Lower Deviation of traverse operation	Lower Dev Run	ON: Lower offset off frequency wobbling	0	0	X	X	X	X	0
40	Switching between motor 1/motor 2	Motor 2 Switch	ON: Start motor 2	0	0	0	0	0	0	0
41	PID Sleep	PID Sleep	ON: PID Sleep	0	0	0	0	0	0	0
42	PG disabled	PG disabled	ON: Speed control without PG	X	0	X	X	X	X	X
43	PG integral reset	I-Time Reset	ON: Integral value reset of speed control with PG	X	0	X	0	0	X	X
44	Mode switching between speed and torque	Speed/Torque change	ON: Torque control mode	X	X	X	0	0	X	X
45	Negative torque command	Reverse Tref	ON: Reverse external torque command	X	X	X	0	0	X	X
46	Zero-servo command	Zero-Servo	ON: Zero-servo operation	X	X	X	0	0	X	X
47	Fire Mode	Fire Mode	ON: Turn off hardware and software fault or alarm protection and run the inverter with value of 01-02 (a special application of HVAC)	0	0	0	0	0	0	0
48	KEB acceleration	KEB Accel.	ON: KEB acceleration start	0	0	X	X	X	X	0
49	Parameters writing allowable	Write Enabled	ON: all parameters are writable OFF: Except reference frequency (00-05) all parameters are write-protected.	0	0	0	0	0	0	0
50	Unattended Start Protection (USP)	USP	ON: After power is input, the inverter ignores the operation command OFF: After power is input, the inverter will return the operation status before power is cut off.	0	0	0	0	0	0	0
51	Mode switching between speed and position	Multi Pos. Switch	ON: Switch to position mode OFF: Switch to speed mode	X	X	X	0	0	X	X
52	Multi Position Reference Enable	Multi Pos. Enable	ON: Position reference is enabled. OFF: Position reference is disabled.	X	X	X	0	0	X	X
53	2-Wire Self Holding Mode (Stop Command)	2-Wire (STOP)	2-Wire Self Holding Mode ( ON: Stop Command).	0	0	0	0	0	0	0
54	Reserved	Reserved	Reserved	-	-	-	-	-	-	-
55	RTC Time Enable	RTC Timer Switch	ON:RTC Time Function Enabled	0	0	0	0	0	0	0
56	RTC Offset Enable	Offset Time Switch	ON:RTC Offset Enable	0	0	0	0	0	0	0
57	Reserved	Reserved	Reserved	-	-	-	-	-	-	-
58	Safety Function	Safety Function	ON: Stop by the setting of 08-30	0	0	0	0	0	0	0
59	Reserved	Reserved	Reserved	-	-	-	-	-	-	-

Value	Function		Description	Control mode						
	Name	LCD Display		V/F	V/F+PG	SLV	SV	PM SV	PM SLV	SLV 2
60	Reserved	Reserved	Reserved	-	-	-	-	-	-	-
61	Reserved	Reserved	Reserved	-	-	-	-	-	-	-
62	EPS function	EPS Input	ON:EPS input	X	X	X	O	O	X	X
63	Reserved	Reserved	Reserved	-	-	-	-	-	-	-
64	Reserved	Reserved	Reserved	-	-	-	-	-	-	-
65	Short-circuit breaking	SC Brk	ON: SC Brk turn on	X	X	X	X	X	O	X
66	PID Disabled 2	PID Disable 2	ON: PID control function is disabled and the last frequency integral is remembered.	O	O	O	O	O	O	O
67	Manual Pulse Generator Mode Switch	HMPG Mode Switch	ON: in general mode, the frequency command is input from analog input AI1 OFF: Manual Pulse Generator Mode	O	X	X	X	X	X	X
68	External Fault 2	Ext. Fault 2	ON: the alarm of external Fault	O	O	O	O	O	O	O
69	External Overload	Ext. Overload	ON: the input of external overload	O	O	O	O	O	O	O

**03-0X =00:** 2-wire control: forward operation

**03-0X =01:** 2-wire control: reverse operation. Refer to the 2-wire operation mode in Figure 4.4.1.

**03-0X =02:** Multi-speed/position setting command 1.

**03-0X =03:** Multi-speed/position setting command 2.

**03-0X =04:** Multi-speed/position setting command 3.

**03-0X =05:** Multi-speed/position setting command 4 (setting =05).

Select frequency reference using multi-function digital input.

In SV or PMSV mode (00-00=3, 4), with 03-00~07 set to 51, multi-speed command can be used to select multiple segment positions.

**03-0X =29:** Jog frequency selection (setting =29). Select frequency reference using the multi-function digital input.

In SV or PMSV mode (00-00=3, 4), with 03-00~07 set to 51, multi-speed command can be used to select multiple segment positions.

**Table 4.4.28 Multi-speed operation selection**

Speed	Multi-function digital input (S1 to S8)					Frequency selection
	Jog frequency reference	Multi-speed frequency 4	Multi-speed frequency 3	Multi-speed frequency 2	Multi-speed frequency 1	
1	0	0	0	0	0	Frequency command 0 ( 05-01) or main speed frequency *2
2	0	0	0	0	1	Auxiliary speed frequency (04-05 = 0) or frequency reference 1 ( 05-02) *3
3	0	0	0	1	0	Frequency command 2 ( 05-03)
4	0	0	0	1	1	Frequency command 3 ( 05-04)
5	0	0	1	0	0	Frequency command 4 ( 05-05)
6	0	0	1	0	1	Frequency command 5 ( 05-06)
7	0	0	1	1	0	Frequency command 6 ( 05-07)
8	0	0	1	1	1	Frequency command 7 ( 05-08)
9	0	1	0	0	0	Frequency command 8 ( 05-09)
10	0	1	0	0	1	Frequency command 9 ( 05-10)
11	0	1	0	1	0	Frequency command 10( 05-11)
12	0	1	0	1	1	Frequency command 11 ( 05-12)
13	0	1	1	0	0	Frequency command 12 ( 05-13)
14	0	1	1	0	1	Frequency command 13( 05-14)
15	0	1	1	1	0	Frequency command 14 ( 05-15)
16	0	1	1	1	1	Frequency command 15 ( 05-16)
17	1 *1	—	—	—	—	Jog frequency command (00-18)

0: OFF, 1: ON, -: Ignore

\*1. Jog frequency terminal has a higher priority than multi-speed reference 1 to 4.

\*2. When parameter 00-05=0 (frequency reference input = digital operator), multi-speed frequency 1 will be set by 05-01 frequency reference setting1). When parameter 00-05=1 (frequency reference input=control circuit terminal), multi-speed frequency command 1 is input through analog command terminal AI1 or AI2).

\*3. Default setting of analog input (AI2) is auxiliary frequency. When 04-05≠0, multi-speed frequency reference is set by 05-02. When PID control mode 10-03=xxx1b (PID Enable), even though 03-00~03-07=16 (PID Control Disable), the auxiliary frequency cannot be switched.

**Wiring Example:** Figure 4.4.17 and 4.4.18 show an example of a 9-speed operation selection.

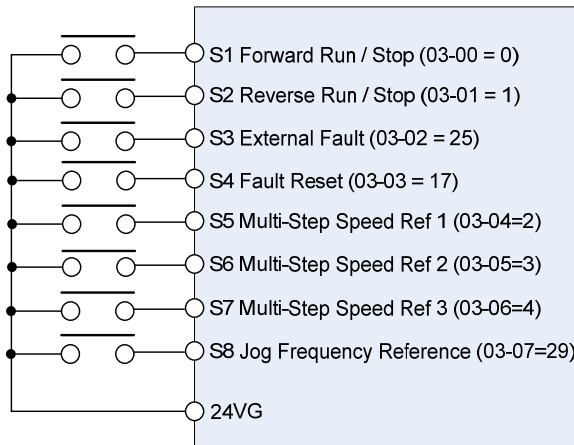

**Figure 4.4.17 Control Terminal Wiring Example**

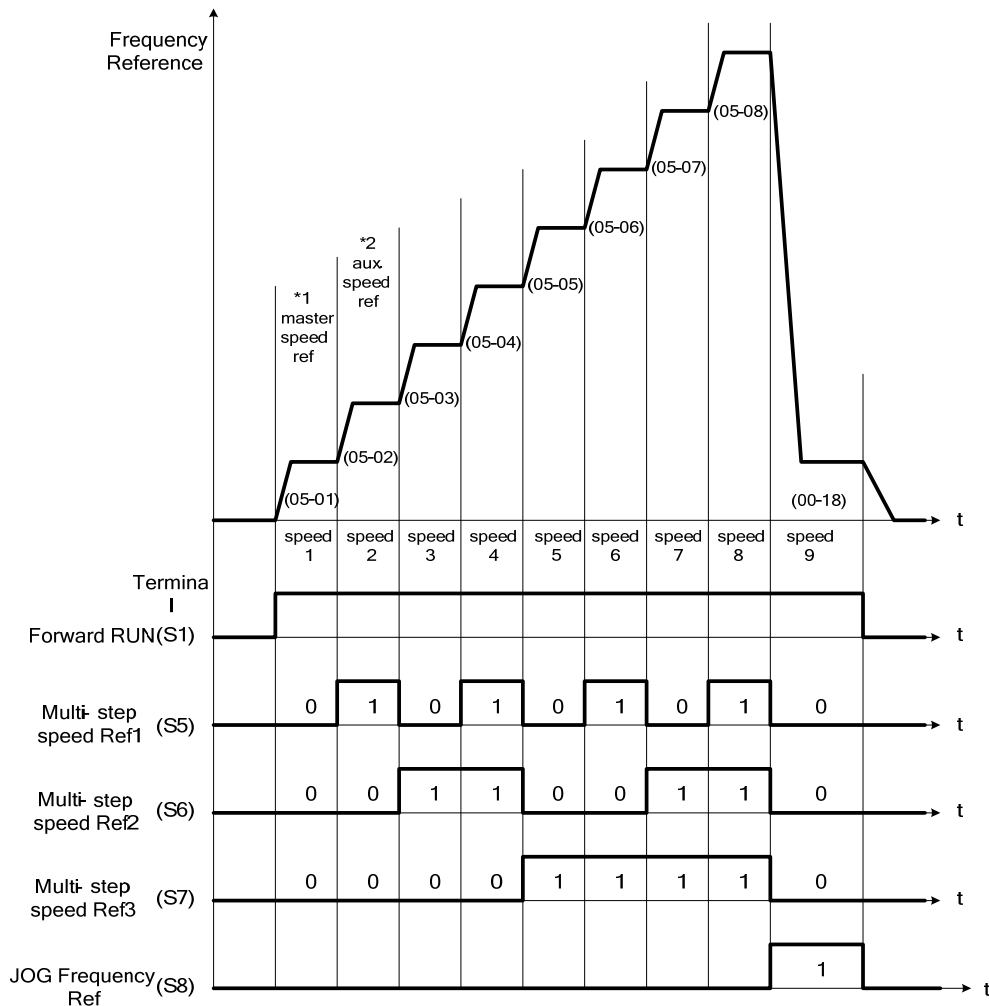

**Figure 4.4.18: 9-speed timing diagram**

- \*1. When 00-05=1, multi-speed frequency reference is set by analog input AI1 or AI2. When 00-05=0, multi-speed frequency reference is set by 05-01.
- \*2. When 04-05=0, multi-speed frequency reference is set by Auxiliary frequency (AI2). When 04-05≠0, multi-speed frequency reference is set by 05-02.

**03-0X =06:** Forward jog run command, uses jog frequency parameter 00-18.

**Note:**

- Jog command has a higher priority than other frequency reference commands.
- Jog command uses stop mode set in parameter 07-09 when Jog command is active > 500ms.

**03-0X =07:** Reverse jog run command, uses jog frequency parameter 00-18.

**Note:**

- Jog command has a higher priority than other frequency reference commands.
- Jog command uses stop mode set in parameter 07-09 when Jog command is active > 500ms.

**03-0X =08:** UP frequency accelerating command; set parameter 00-05 Frequency command to 2 to activate.

**03-0X =09:** Down frequency decelerating command; set parameter 00-05 Frequency command to 2 to activate.

**Note:**

- The inverter operates the variation of increasing/ decreasing output frequency via keypad (refer to parameter 11-56) / external multi-function digital input (terminal S1to S8) when the motor is running.
- It is required to use two terminals to run UP/ DOWN command when the inverter runs this command via the external multi-function digital input terminal and 00-02=1 (external terminals) & 00-05=2 (terminal command UP/DOWN) & 03-00~03-07=8 (UP command)/ 9 (DOWN command).
- The inverter output frequency runs UP/ DOWN command with the setting of acceleration/ deceleration time.

**Note:** SE02 DI terminal Error will be displayed when:

- Only the UP or DOWN command function is set.
- Both UP command and Inhibit Acceleration/deceleration command are activated simultaneously.
- Both DOWN command and Inhibit Acceleration/deceleration command are activated simultaneously.

For the examples of UP/DOWN control wiring and operation, please refer to figure 4.4.19 and 4.4.20.

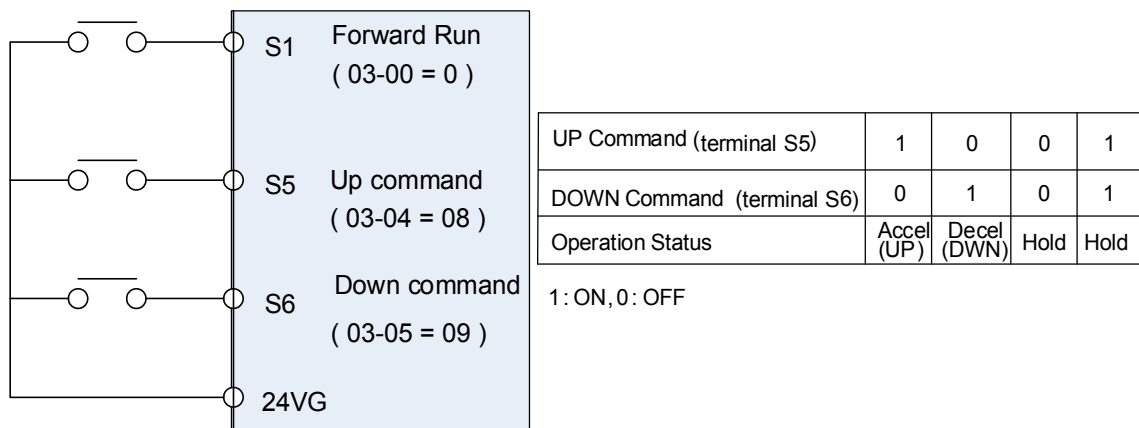

**Figure 4.4.19 UP/DOWN wiring and operation example**

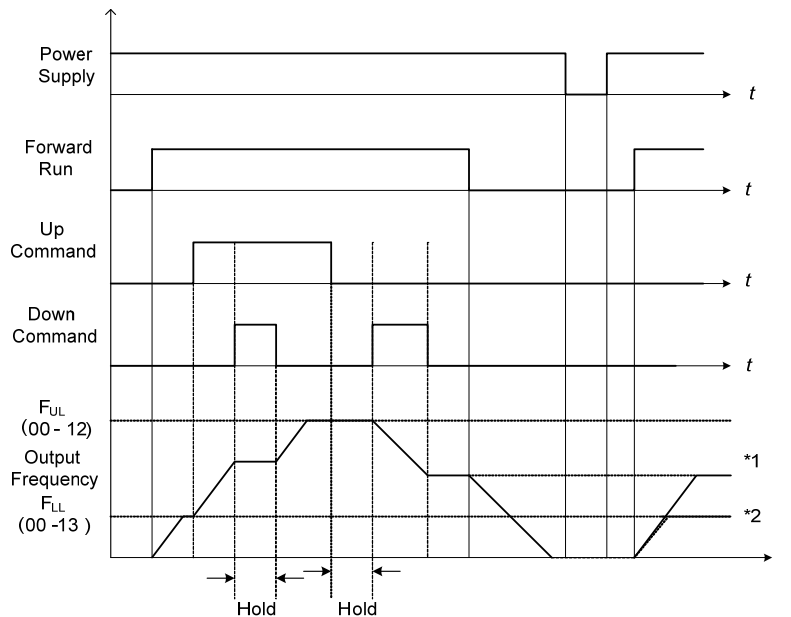

**Figure 4.4.20 Up / Down command timing diagram**

### UP / DOWN Command Operation

When the Forward Run command is active and the UP or Down command is momentarily activated the inverter will accelerate the motor up to the lower limit of the frequency reference (00-13).

When using the UP / Down command, the output frequency is limited to the upper limit of frequency reference (00-12) and the lower limit of frequency reference (00-13).

The UP / DOWN command uses acceleration 1 or 2 / deceleration time 1 or 2 for normal operation  $T_{acc1}$  /  $T_{dec1}$  (00-14, 00-15) or  $T_{acc2}$  /  $T_{dec2}$  (00-16, 00-17).

\*Refer to parameter 03-40 of UP/ Down frequency width setting for other functions of UP / Down.

Frequency reference retention is active when parameter 11-58 is set to 1 and the frequency reference is saved when power is lost and retrieved when power is restored.

\*1: When 11-58 = 1 and the operation command is active, the output frequency will accelerate to the previously stored frequency command.

\*2: When 11-58 = 0 and the operation command is active, the output frequency will accelerate to the lower limit of frequency reference (00-13).

**03-0X =10:** Acceleration/deceleration 1 selection

**03-0X =30:** Acceleration/deceleration 2 selection

Refer to the "multi-function digital input terminals select acceleration / deceleration time" page 4-76.

**03-0X =11:** Acceleration/deceleration inhibition command (hold command)

When acceleration/deceleration inhibition command is active, inverter suspends the motor's acceleration / deceleration operation and maintains the output frequency at current level. Refer to the record reference frequency (parameter 11-58).



\*1. 11-58 = 1,

When acceleration / deceleration inhibition command is activated, the frequency reference is stored even when powering down the inverter.

When a run command is given (e.g. run forward) and the acceleration / deceleration inhibit command is active, the inverter will accelerate to the previously stored frequency reference.

\*2. 11-58 = 0,

When acceleration / deceleration inhibition command is ON, the motor suspends at the output frequency which is the frequency reference command.

When acceleration / deceleration inhibition command is OFF or inverter stop command is active, the frequency reference command will restore to the pre-set frequency. The output frequency remains at 0 Hz when the stop command and power down reset.

Note: If acceleration / deceleration inhibition command is ON before operation, STP0 signal will occur after operation because there is no record reference frequency.

Refer to Figure 4.4.21. for an example.

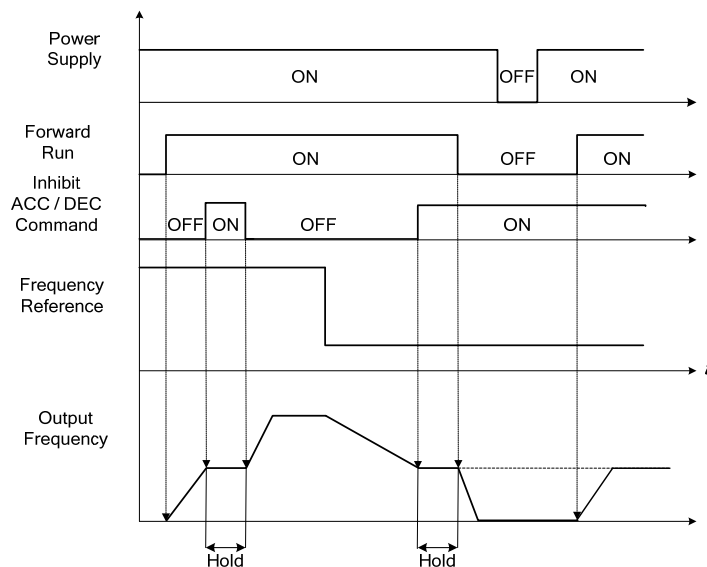

**Figure 4.4.21 Acceleration/ deceleration inhibition command operation**

**03-0X =12: Main/ Alternative Run Switch Function**

When function terminals conduct, run command source is set in alternative run command (00-03). When functional terminal is set to 27 (Local/ Remote control selection), it will be precedential to main/alternative run switch.

**03-0X =13: Main/ Alternative Frequency Switch Function**

When function terminals conduct, frequency command source is set in alternative frequency command (00-06). When functional terminal is set to 27 (Local/ Remote control selection), it will be precedential to main/alternative frequency switch. When PID function is active(10-03=XXX1B),this function is invalid and main frequency is switched to PID function. When PID function is invalid, Main/ Alternative frequency switch function is valid then.

**03-0X =14: Emergency stop (decelerate to zero and stop)**

Refer to the "deceleration time of emergency stop" of parameter 00-26

**03-0X =15: External Baseblock Command (coast to stop)**

Execute the base block command by the use of ON / OFF way of multi-function digital input terminal, and prohibit

the inverter output.

**During run:** When an external base block command is activated, the keypad displays "BBn BaseBlock (Sn)", indicating the inverter output is turned off (n indicates the digital input number 1 – 8). Upon removing the base block signal, the motor will run at the frequency reference. If speed search from frequency reference is active the inverter output frequency starts from the frequency reference and searches for the coasting motor speed and continue to operate. If speed search is not active the output frequency starts at 0Hz.

**During deceleration:** When an external base block command is activated, the keypad displays "BBn BaseBlock (Sn)", indicating the inverter output is turned off (n indicates the digital input number 1 – 8). Upon removing the base block signal, the motor is stopped or will coast to a stop and the inverter will remains in the stop condition.

**During acceleration:** When an external base block command is activated, the keypad displays "BBn BaseBlock (Sn)", indicating the inverter output is turned off (n indicates the digital input number 1 – 8). Upon removing the base block signal, the motor will run at the frequency reference. If speed search from frequency reference is active the inverter output frequency starts from the frequency reference and searches for the coasting motor speed and continue to operate. If speed search is not active the output frequency starts at 0Hz.

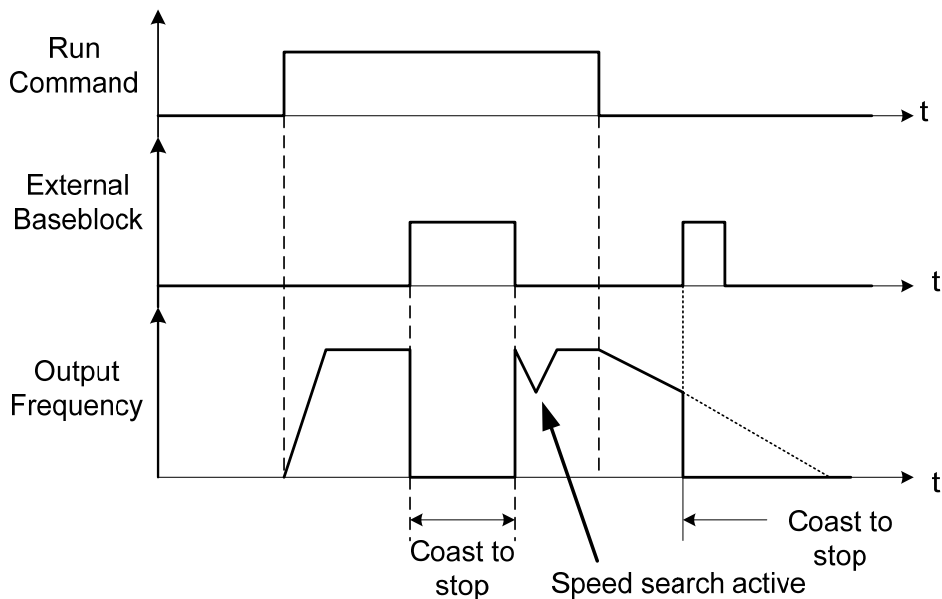

**Figure 4.4.22 External base block operation**

**03-0X =16:** PID control disabled.

**03-0X =17:** Fault reset

The output becomes active when the inverter trips on a fault. Upon an inverter fault the inverter output will turn off (base block) and the keypad displays the dedicated fault message.

When fault occurs, the following actions can be used to reset the fault:

1. Program one of the multi-function digital inputs (03-00 to 03-07) to 17 (reset fault) and active input.\*
2. Press the reset key of the digital operator (RESET).\*
3. Recycle power to the inverter.

**Important Note:** If a run command is active during power-up, the inverter will start running automatically.

\* To reset an active fault the run command has to be removed.

**03-0X =19:** Speed Search 1 (from the maximum frequency).

**03-0X =34:** Speed Search 2 (from the frequency command).

Refer to the "speed search" function.

**03-0X =20:** Energy saving enabled

Manual energy savings function is set with parameters 11-12 and 11-18.

For the manual energy saving operation refer to Figure 4.4.88.

**03-0X =21:** PID integral reset

**03-0X =24:** PLC Input

It is required to be with the software of Drive Link. PLC software program conducts the ladder diagram editing. When the signal output conducts, it will be transmitted to the inverter to be active.

**03-0X =25:** External fault

Activating the external fault input will turn off the inverter output and the motor will coast to a stop. The keypad displays the external fault message "EFn Ext. Fault (Sn)", where n is the input terminal number.

**03-0X =26:** 3-wire sequence (forward / reverse command)

When digital input terminals S3~S6 are set to 26, terminals S1 and S2 will be individually changed to run command and stop command. Refer to the 3-wire operation mode in Figure 4.4.2 for details.

**03-0X =27:** Local / Remote selection.

Switch the inverter frequency reference source between Local (keypad) or Remote (control circuit terminals or RS485). Use parameter 00-05 (Main frequency command source selection) and 00-02 (Run command selection) to select the remote source.

**Note:** In 3-wire operation terminal S1 and S2 are reserved for run/stop operation and the Local / Remote function can only be set to digital input terminals S3 to S8 (03-02 to 03-07).

**Note:** To switch between local and remote the inverter has to be stopped.

Input	Mode	Frequency Reference / Run/Stop Command Source
ON	Local	- Frequency reference and Run-Stop from keypad. - LEDs SEQ and REF are off.
OFF	Remote	- Frequency reference source selected by parameter 00-05 and Run-Stop source selected by parameter 00-02. - LEDs SEQ and REF are on.

**03-0X =28:** Remote mode selection

Switch between terminal source and communication (RS-422/RS-485) source for frequency reference and operation command.

In Remote mode, indicators of SEQ and REF are on; you can use terminals AI1 and AI2 to control the frequency command, and use terminals S1, S2 or communication terminal RS-485 to control the operation command.

Input	Mode	Frequency Reference / Run/Stop Command Source
ON	Communication	- Frequency reference and run/stop command control via communication (RS-422/RS-485).
OFF	Terminal	- Frequency reference source from AI1 / AI2 input (00-05=1) and Run-Stop command from terminals S1 / S2 (00-02=1).

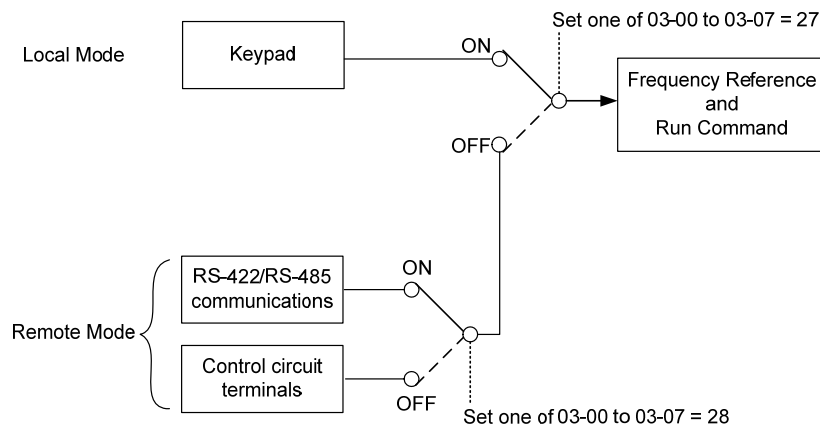

**Figure 4.4.23 Remote mode operation selection**

To switch the frequency reference and operation command input between communication RS-485 and control terminals the following parameters have to be set:

1. 00-05=1 (use control terminal AI1 or AI2 as reference frequency source)
2. 00-02=1 (use control terminal S1 or S2 for operation command)
3. Set one of the digital input terminals (03-02 to 03-07) to 28 (Operation selection of remote mode)

**03-0X =24:** PLC Input

It is required to match Drive Link program. Ladder diagram is edited in the PLC program. When the message output is conducted, this message will be sent to the inverter.

**03-0X =26:** 3-Wire Sequence (Forward/ Reverse Command)

When the digital input terminals (S3~S6) is set to 26, terminal S1 and S2 will become the run command and stop command. Refer to Fig.4.4.2.

**03-0X =29:** Jog Frequency Selection

When jog frequency selection is on, the inverter will depend on the parameter 00-18 (jog frequency) as the command.

**03-0X =30:** Acceleration/ Deceleration Time Selection 2

When accel./ decel. time selection 2 is ON, the inverter will depend on the parameter 00-16 acceleration time 2 and the parameter 00-17 deceleration time 2.

**03-0X =31:** Inverter overheat warning

When input is active the inverter displays warning message "OH2" and continues operation. Deactivating the input reverts back to the original display. Warning message does not require resetting the inverter.

**03-0X =32:** Sync command

Selects between frequency reference source from pulse input or frequency reference source selected by parameter 00-05.

Input	Ref. Source	Frequency Reference / Run/Stop Command Source
ON	Pulse Input	- Frequency reference set by pulse input
OFF	Parameter 00-05	- Frequency reference source selected by parameter 00-05

**Note:**

- Function is disabled when the Local/Remote selection (25) or Remote mode selection (26) is active.
- To switch between local and remote the inverter has to be stopped.

**03-0X =33:** DC braking

When input is active DC-Injection braking is enabled during start and stopping of the inverter. DC Injection braking is disabled when a run or jog command is active. Refer to the DC braking time diagram in Figure 4.4.24.

**Note:** Short-circuit braking command or DC braking command can only be selected. If they are set simultaneously, SE02 error (DI Terminal Error) will occur.

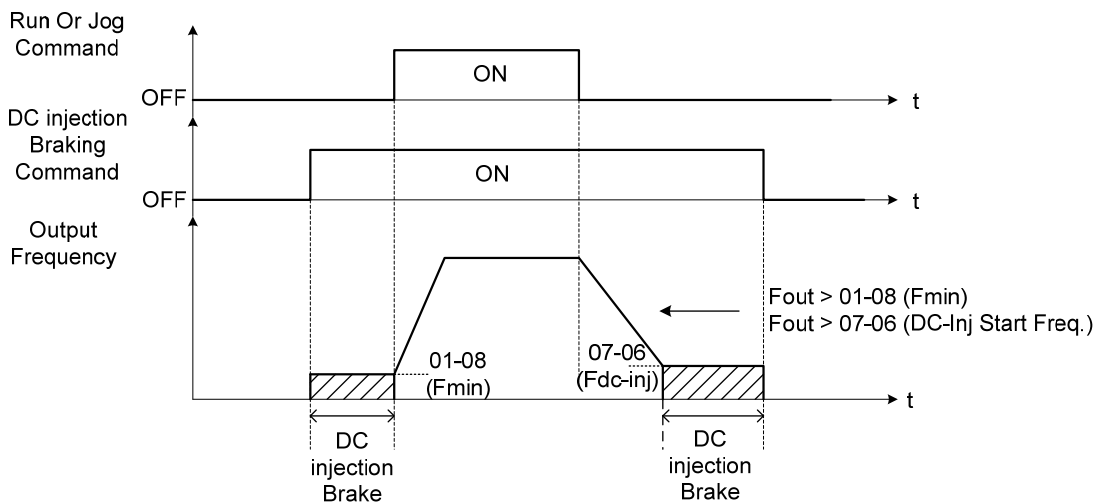

**Figure 4.4.24 DC braking timing diagram**

**03-0X =35:** Timing function

Refer to the "time function" parameter 03-37 and 03-38.

**03-0X =36:** PID Soft start disable

Refer to the "PID Control" function of PID function parameter group 10.

**03-0X =37:** Traverse operation

**03-0X =38:** Upper Deviation of traverse operation

**03-0X =39:** Lower Deviation of traverse operation  
See “Wobble Frequency” function in parameter group 19

**03-0X =40:** Switching between motor 1 and motor 2

**03-0X =41:** PID Sleep  
Set parameter 10-29 to 2 (active by DI) and refer to the descriptions of parameters 10-17~10-20.

**03-0X =42:** PG disable  
When input is active PG feedback is disabled and speed control is set to V/F control.

**03-0X =43:** PG integral reset  
When input is active, reset PG speed control integral accumulator.  
**Note:** Only applies to closed loop control modes.

**03-0X =44:** Mode switching between speed and torque  
Active in SV (sensor vector control mode). When input is active switch control between speed and control mode.  
Refer to parameter group 21 for more information.

Input	Control
ON	Torque Control
OFF	Speed Control

**03-0X =45:** Negative torque command  
When input is active reverses torque reference command. Refer to Figure 4.4.128 for more details.

**03-0X =46:** Zero-servo Command; Start: zero-servo operation.  
When input is active starts zero-servo operation. Refer to Figure 4.4.129 for more details.

**03-0X =47:** Fire mode  
When input is active disables all inverter warning and hardware protections. This function is commonly used in commercial applications where the inverter controls an exhaust fan and needs run to destruction in case of a fire.

**03-0X =48:** KEB acceleration  
When input is active enables KEB (Kinetic Energy Braking) during acceleration. Refer to the parameter description of 11-47 and 11-48. Note: To enable set parameter 11-47 to a value greater than 0.

**03-0X =49:** Parameters write-in allowed  
When input is active allows parameter to be changed.

**Note:** When none of the digital input terminals are set to function 49, parameter write-in protection is controlled by parameter 13-06.

Input	Parameter Save
ON	Parameters Write Enabled
OFF	Parameters Write Protected

**03-0X =50: Unattended Start Protection (USP)**

When input is active prevents inverter from starting automatically when a run command is present at time of power-up. Please refer to Figure 4.4.24a for more details.

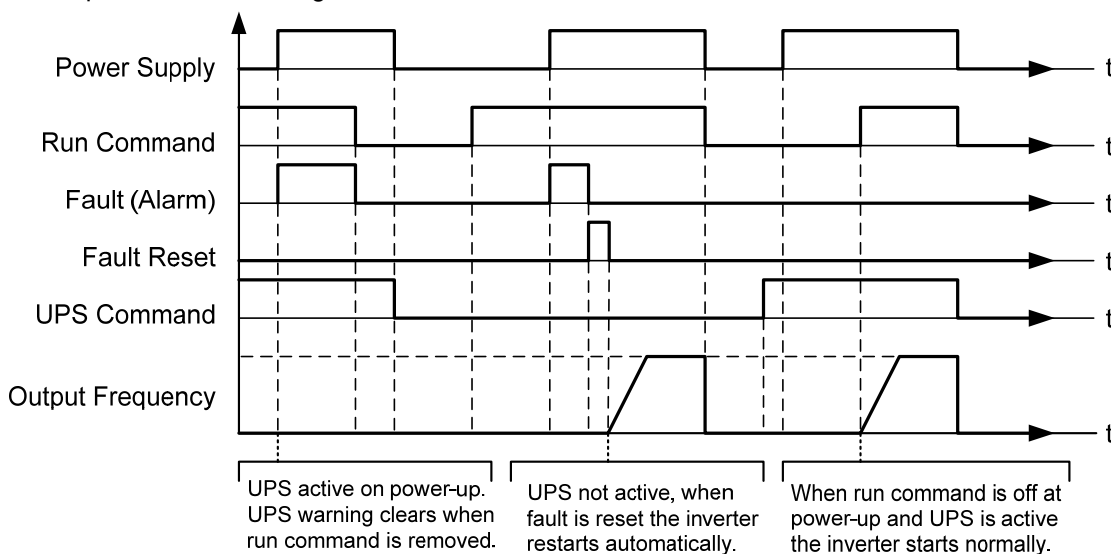

**Figure 4.4.24a Unattended Start Protection**

**03-0X =51: Mode switching between speed and position control.**

Refer to the parameter description of 21-09 ~ 21-41

Input	Control
ON	Position Control
OFF	Speed Control

**03-0X =52: Multi Position Reference Enable**

Refer to the parameter description of 21-09~21-41

**03-0X =53: 2-Wire Self-holding Mode (Stop Command)**

Refer to parameter description of 00-02 (2-wire operation with self-holding function)

**03-0X =55: RTC Time Enable**

When 16-13 (RTC timer function) = 2 (DI setting) and RTC Time Enable is ON, RTC timer function is enabled.

**03-0X =56: RTC Offset Enable**

When 16-30 (Selection of RTC Offset) = 2 (DI setting) and RTC Offset Enable is ON, the inverter will run depending on RTC offset time setting (16-31).

**03-0X =58: Safety function**

When safety function is on, the inverter will stop depending on the setting of 08-30 after the digital terminal is active.

**03-0X =62: EPS function**

EPS input is valid when low voltage activate. Please refer to page 4-84

**03-0X =65: Short-circuit braking**

To stop inverter by turning on Short-circuit braking with setting terminal. If executing run command or jog command, short-circuit braking command will erased and start to run. The following picture is short-circuit braking time process.

**Note:** Short-circuit braking command or DC braking command can only be selected. If they are set simultaneously, SE02 error (DI Terminal Error) will occur.

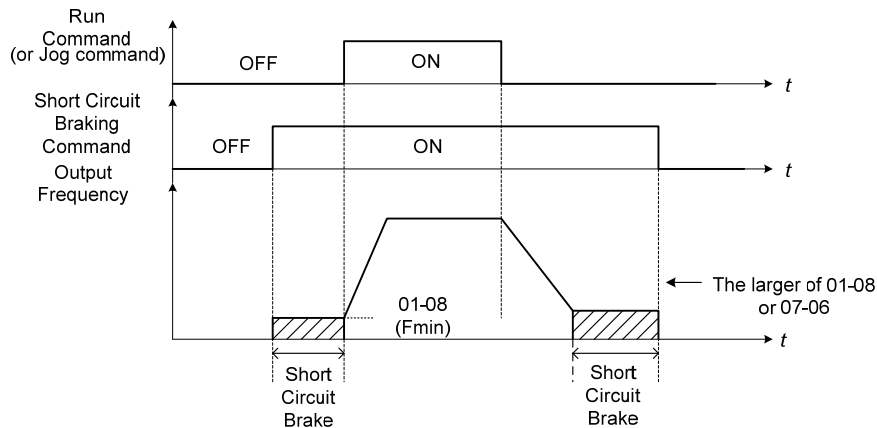

**03-0X =66:** PID Disabled 2

When PID is disabled, the main frequency command source (00-05) is active; when PID is enabled, the previous frequency command is integrated and PID mode is active.

**03-0X =67:** Manual Pulse Generator Mode Switch

When 00-32=8 (HMPG), MPG switch mode is enabled. The frequency command in general mode runs depending on analog input AI1 and that in MPG mode runs depending on pulse input. Please refer to the following diagram for further descriptions.

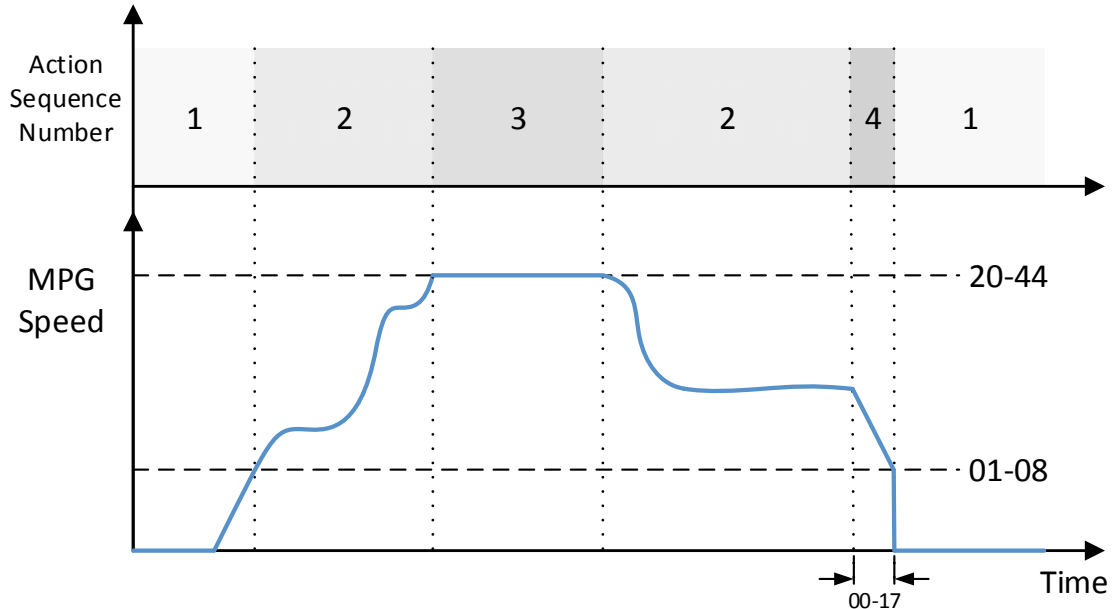

Descriptions of MPG action sequence number:

- 1: When run command starts, the injection current is determined by parameter 07-46 during the braking action from DC current injection motor. When run command is canceled, DC current injection stops.
- 2: When MPG speed is higher than the minimum output frequency of motor 1 (parameter 01-08), the inverter starts output frequency by V/f curve. If the output torque is inadequate, please set up the V/f curve parameters of 01-06、01-07、01-08、01-09.
- 3: When MPG speed is higher than the speed command limit of parameter 20-44, the inverter output



frequency will be limited to the set rotation speed by parameter 20-44.

- 4: When MPG stops running (stop pulse input), the motor speed will start to decelerate depending on the set value of deceleration time 2 (parameter 00-17). When the motor speed is lower than the minimum output frequency of motor 1, the motor will start DC current injection brake action.

Note: When MPG generates pulse input to PG card, the speed command will be calculated. Then, the speed command is multiplied by the speed magnification (parameter 20-43). It is filtered by the set ASR delay time (parameter 20-08). Selection of PG rotation direction (Parameters 20-28) can be set to determine if the MPG and the motor rotation are in the same direction.

Note: When V/f curve parameters 01-06, 01-07, 01-08 and 01-09 are adjusted, it is necessary to note the inverter output current (parameter 12-18) to avoid all kinds of fault conditions leading to possible industrial safety accidents.

➤ Please refer to the following flow chart for the Parameter Setting:

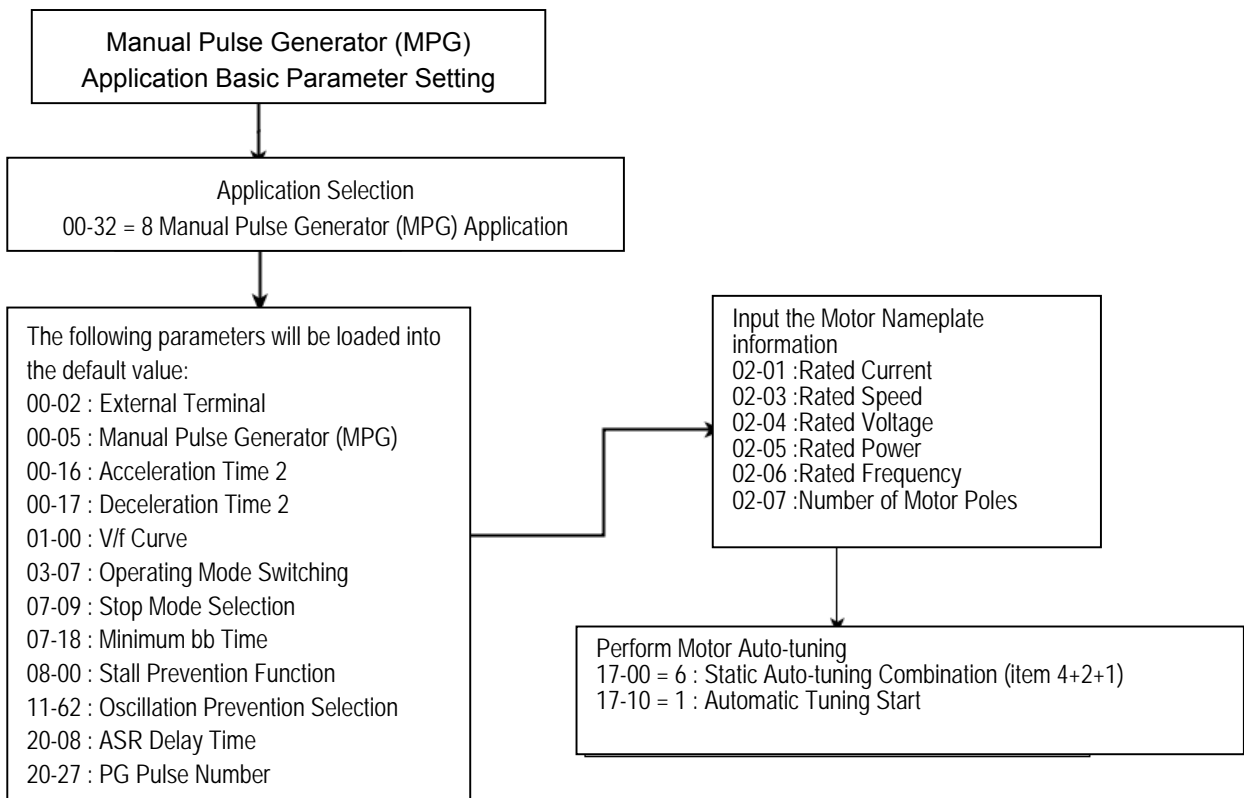

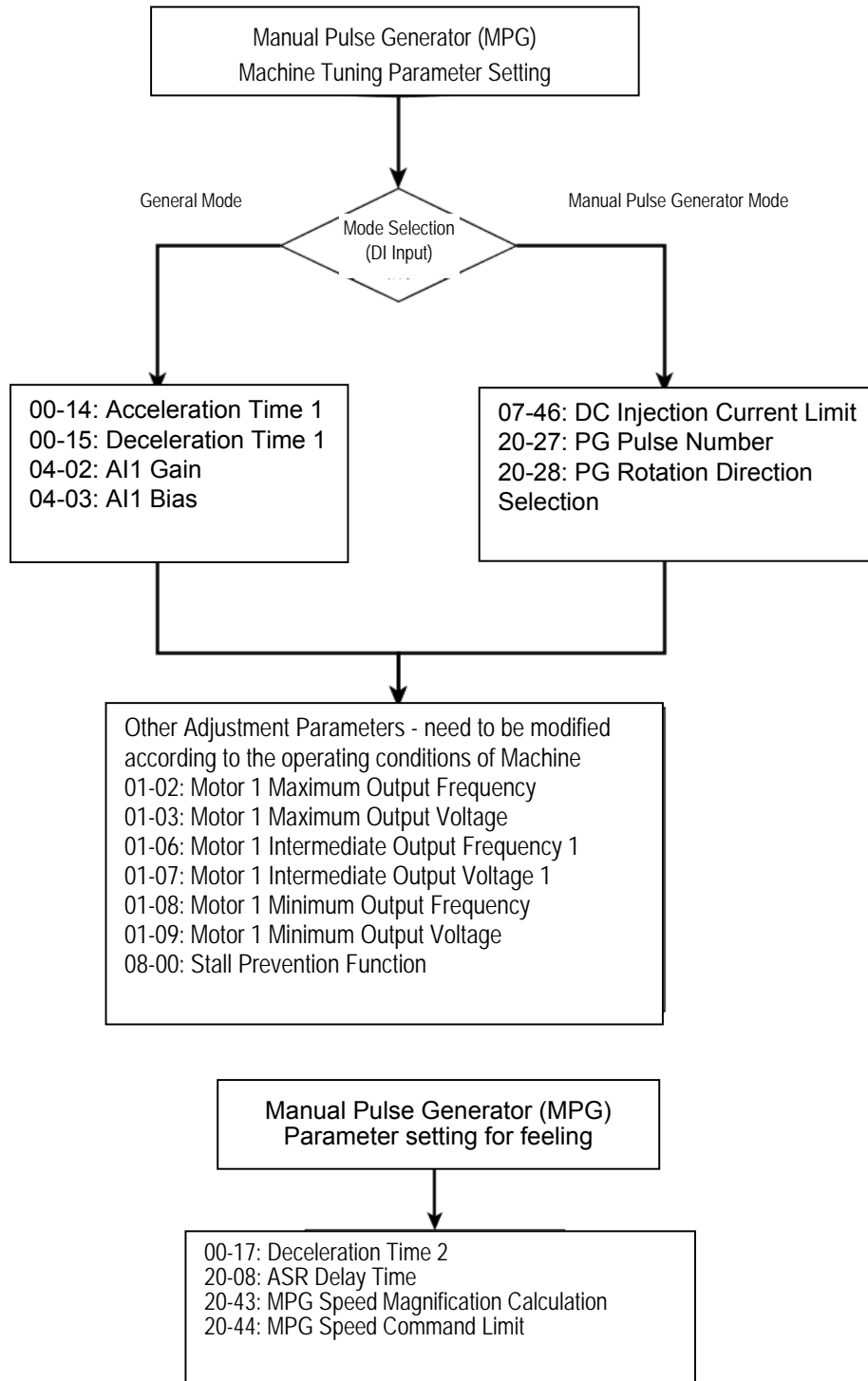

**03-0X =68: External Fault 2**

- When an external fault occurs, the external fault 2 input terminal is turned on, the inverter will be turned off and the motor will free run to stop.
- If external input terminal S3 is set (03-02 = 68) as external fault, the message “EF3 Ext. Fault (S3)” (EF3) will be displayed.
- All eight input terminals (S1 to S8) can be designated as external fault input.

**03-0X =69: External Overload, input terminal is normally closed.**

- When external overload occurs, the external overload input terminal closed, the inverter will be turned off and the motor will decelerate to stop.
- If the external input terminal S5 is set (03-04 = 69) to external overload, “TOL Ext. OverLoad” message will

be displayed.

- To enable the external overload function, the fire mode must be enabled first (08-48 =1), only the external input terminal S5 can be designated as External Overload Input.
- Setting the external input terminal as External Overload will set the input terminal as the normally closed, therefore, before setting the external overload function, do not set the operation command from the external terminal, otherwise, it will cause unnecessary damage.

<b>03-08</b>	<b>(S1~S8) DI scan time</b>
<b>Range</b>	<b>0:</b> scan time 4ms <b>1:</b> scan time 8ms

Set the digital input CPU scan time. The digital input signal needs to be present for the minimum scan time to qualify as a valid command.

**Note:** For noisy environments select scan time of 8ms (results in a slower response time).

<b>03-09</b>	<b>Multi-function terminal S1-S4 type selection</b>
<b>Range</b>	xxx0b: S1 A contact    xxx1b: S1 B contact xx0xb: S2 A contact    xx1xb: S2 B contact x0xxb: S3 A contact    x1xxb: S3 B contact 0xxxb: S4 A contact    1xxxb: S4 B contact

<b>03-10</b>	<b>Multi-function terminal S5-S8 type selection</b>
<b>Range</b>	xxx0b: S5 A contact    xxx1b: S5 B contact xx0xb: S6 A contact    xx1xb: S6 B contact x0xxb: S7 A contact    x1xxb: S7 B contact 0xxxb: S8 A contact    1xxxb: S8 B contact

Parameter 03-09 and 03-10 selects the digital input type between a normally open and a normally closed switch/contact.

Each bit of 03-09/03-10 presents an input :

**03-09=** 0 0 0 0    **0:** normally open switch  
          s4 s3 s2 s1    **1:** normally close switch

**03-10=** 0 0 0 0    **0:** normally open switch  
          s8 s7 s6 s5    **1:** normally close switch

**Example:** S1 and S2 wired to a normally closed contact / switch set 03-09=0011.



Do not set the operation command parameter 00-02 to terminal control before setting the digital input type. Failure to comply may cause death or serious injury.

<b>03-11</b>	<b>Relay (R1A-R1C) output</b>
<b>03-12</b>	<b>Relay (R2A-R2C) output</b>
<b>03-20</b>	<b>Relay (R4A-R4C) output</b>
<b>Range</b>	0: During Running 1: Fault contact output 2: Frequency Agree 3: Setting Frequency Agree (03-13 ± 03-14) 4: Frequency detection 1 (> 03-13, hysteresis range is the setting value of 03-14) 5: Frequency detection 2 (< 03-13, hysteresis range is the setting value of 03-14) 6: Automatic restart 7~8: Reserved 9: Baseblock 10~11: Reserved 12: Over-Torque Detection 13: Current Agree 14: Mechanical Braking Control (03-17~18) 15~17: Reserved 18: PLC status 19: PLC control contact 20: zero speed 21: Inverter Ready 22: Undervoltage Detected 23: Source of operation command 24: Source of frequency command 25: Low torque detected 26: Frequency reference missing 27: Time function output 28: Traverse operation UP status 29: During Traverse operation status 30: Motor 2 selection 31: Zero Speed Servo Status (Position Mode) 32: Communication control contacts 33: RTC Timer 1 34: RTC Timer 2 35: RTC Timer 3 36: RTC Timer 4 37: PID feedback loss detection output 38: Brake release 39: Frequency Detection 1 (dedicated for Crane) 40: Frequency Output 41: Position Agree (Position Mode) 42~44: Reserved 45: PID sleep 46~49: Reserved 50: Frequency Detection 3 ( $\geq$ 03-44+03-45) 51: Frequency Detection 4 ( $\leq$ 03-44+03-45) 52: Frequency Detection 5 ( $\geq$ 03-46+03-47) 53: Frequency Detection 6 ( $\leq$ 03-46+03-47)

	54: Turn on short-circuit braking 57: Low Current Detection 58: Frequency Deceleration Detection 59: Over-Temperature Detection
--	--

Note: For frame 1, the DO2 function is setting by 03-12.

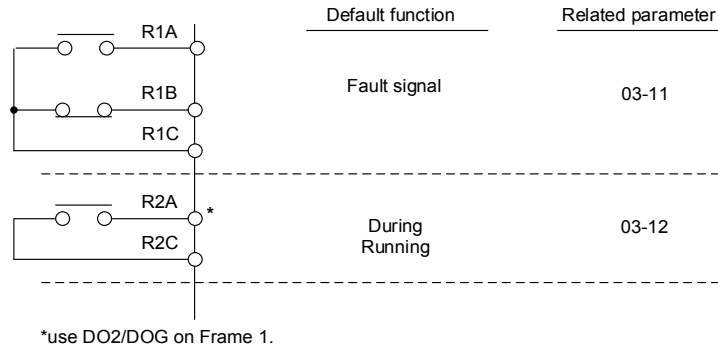

Figure 4.4.25 Multi-function digital output and related parameters

- The following table is the parameter setting in the control board and optical coupler.

Terminal	Frame 1 ( for H & C type)	Frame 2 and above ( for H & C type) All frame ( for E & G type)
R1A-R1C	03-11=R1A-R1C	03-11=R1A-R1C
R2A-R2C	none	03-12=R2A-R2C
D02(PH2)	03-12=D02(PH2)	none
D01(PH1)	03-28=D01(PH1)	03-28=D01(PH1)

Table 4.4.29 Function table of multi-function digital output

Setting	Function		Contents	Control mode						
	Name	LCD display		V/F	V/F + PG	SLV	SV	PM SV	PM SLV	SLV 2
0	During Running	Running	ON: During running (Run Command is ON)	○	○	○	○	○	○	○
1	Fault contact output	Fault	ON: Fault contact output (except CF00 and CF01 )	○	○	○	○	○	○	○
2	Frequency agree	Freq. Agree	ON: frequency agree (frequency agree width detection is set by 03-14 )	○	○	○	○	○	○	○
3	Setting frequency agree	Setting Freq Agree	ON: Output frequency = allowed frequency detection level (03-13) ± frequency bandwidth (03-14)	○	○	○	○	○	○	○
4	Frequency detection 1 (> 03-13)	Freq. Detect 1	ON: Output frequency > 03-13 Hysteresis range is 03-14	○	○	○	○	○	○	○
5	Frequency detection 2 (< 03-13)	Freq. Detect 2	OFF: Output frequency > 03-13, Hysteresis range is 03-14	○	○	○	○	○	○	○
6	Automatic restart	Auto Restart	ON: the period of automatic restart	○	○	○	○	○	○	○

Setting	Function		Contents	Control mode						
	Name	LCD display		V/F	V/F + PG	SLV	SV	PM SV	PM SLV	SLV 2
7	Reserved	Reserved	Reserved	-	-	-	-	-	-	-
8	Reserved	Reserved	Reserved	-	-	-	-	-	-	-
9	Baseblock	Baseblock	ON: During baseblock	0	0	0	0	0	0	0
10	Reserved	Reserved	Reserved	-	-	-	-	-	-	-
11	Reserved	Reserved	Reserved	-	-	-	-	-	-	-
12	Over-Torque Detection	Over Torque	ON: Over torque detection is ON	0	0	0	0	0	0	0
13	Current Agree	Current Agree	ON: when output current > 03-15 is ON	0	0	0	0	0	0	0
14	Mechanical Braking Control (03-17~18)	Mechanical Brake Control	ON: Mechanical braking release frequency OFF: Mechanical braking run frequency	0	0	0	0	0	0	0
15	Reserved	Reserved	Reserved	-	-	-	-	-	-	-
16	Reserved	Reserved	Reserved	-	-	-	-	-	-	-
17	Reserved	Reserved	Reserved	-	-	-	-	-	-	-
18	PLC status	PLC statement	ON: when 00-02 is set to 3 (PLC operation command source)	0	0	0	0	0	0	0
19	PLC control contact	Control From PLC	ON: Control from PLC	0	0	0	0	0	0	0
20	Zero speed	Zero Speed	ON: Output frequency < Minimum output frequency (Fmin)	0	0	0	0	0	0	0
21	Inverter Ready	Ready	ON: Inverter ready (after power on, no faults)	0	0	0	0	0	0	0
22	Undervoltage Detection	Low Volt Detected	ON: DC bus voltage = < Low-voltage warning detection level (07-13)	0	0	0	0	0	0	0
23	Source of operation command	Run Cmd Status	ON: operation command from LED digital operator (local mode)	0	0	0	0	0	0	0
24	Source of reference command	Freq Ref Status	ON: reference frequency from LED digital operator (local mode)	0	0	0	0	0	0	0
25	Low torque detected	Under Torque	ON: Low-torque detection is ON	0	0	0	0	0	0	0
26	Frequency reference missing	Ref. Loss.	ON: Reference frequency loss	0	0	0	0	0	0	0
27	Timing function output	Time Output	Set time function parameter to 03-33 and 03-34 · and the time function input is set by parameter from 03-00 and 03-07	0	0	0	0	0	0	0
28	Traverse operation UP Status	Traverse UP	ON: in acceleration period (when the wobbling is in operating )	0	0	X	X	X	X	0
29	During Traverse operation status	During Traverse	ON: In the period of frequency wobbling operation (when the wobbling is in operating )	0	0	X	X	X	X	0
30	Select motor 2	Motor 2 Selection	ON: Switch to motor 2	0	0	0	0	0	0	0

Setting	Function		Contents	Control mode						
	Name	LCD display		V/F	V/F + PG	SLV	SV	PM SV	PM SLV	SLV 2
31	Zero Speed Servo Status (Position Mode)	Zero Servo	ON: Zero servo function is active	X	X	X	O	O	X	X
32	Communication control contacts	Control From Communication	ON: Communication control contacts (location:2507H).	O	O	O	O	O	O	O
33	RTC Timer 1	RTC Timer 1	ON: 16-36 (RTC Speed Selection) selects Timer 1 and 16-32 (Source of Timer 1) is active in the set time.	O	O	O	O	O	O	O
34	RTC Timer 2	RTC Timer 2	ON: 16-36 (RTC Speed Selection) selects Timer 2 and 16-33 (Source of Timer 2) is active in the set time.	O	O	O	O	O	O	O
35	RTC Timer 3	RTC Timer 3	ON: 16-36 (RTC Speed Selection) selects Timer 3 and 16-34 (Source of Timer 3) is active in the set time.	O	O	O	O	O	O	O
36	RTC Timer 4	RTC Timer 4	ON: 16-36 (RTC Speed Selection) selects Timer 4 and 16-35 (Source of Timer 4) is active in the set time.	O	O	O	O	O	O	O
37	PID Feedback Loss Detection Output	PID Fbk Loss	ON: PID Feedback Loss	O	O	O	O	O	O	O
38	Break Release	Brake Release	ON: Release Brake	X	X	O	O	O	X	X
39	Frequency Detection 1 (dedicated for Crane)	Freq. Detect 1 (Dedicated crane)	ON: Output frequency > 03-13, Hysteresis range : 03-14	O	O	O	X	X	X	X
40	Frequency Output	Frequency output Ing	ON: Inverter status is at DC brake, Base Block or stop.	X	X	X	O	X	X	X
42	Reserved	Reserved	Reserved	-	-	-	-	-	-	-
43	Reserved	Reserved	Reserved	-	-	-	-	-	-	-
44	Reserved	Reserved	Reserved	-	-	-	-	-	-	-
45	PID sleep	PID Sleep	ON: During PID Sleep	O	O	X	X	X	X	X
46	Reserved	Reserved	Reserved	-	-	-	-	-	-	-
47	Reserved	Reserved	Reserved	-	-	-	-	-	-	-
48	Reserved	Reserved	Reserved	-	-	-	-	-	-	-
49	Reserved	Reserved	Reserved	-	-	-	-	-	-	-
50	Frequency Detection 3	Freq. Detect 3	ON: output frequency > 03-44, Hysteresis range :03-45	O	O	O	O	O	O	O
51	Frequency Detection 4	Freq. Detect 4	OFF: output frequency > 03-44, Hysteresis range :03-45	O	O	O	O	O	O	O
52	Frequency Detection 5	Freq. Detect 5	ON: output frequency > 03-46, Hysteresis range :03-47	O	O	O	O	O	O	O
53	Frequency Detection 6	Freq. Detect 6	OFF: output frequency > 03-46, Hysteresis range :03-47	O	O	O	O	O	O	O
54	Turn on short-circuit braking	SC Brk	ON: Turn on short-circuit braking	X	X	X	X	X	O	X
57	Low Current Detection	Low Current Detect	ON: Output Current $\leq$ 03-48 Low current detection level	O	O	O	O	O	O	O

Setting	Function		Contents	Control mode						
	Name	LCD display		V/F	V/F + PG	SLV	SV	PM SV	PM SLV	SLV 2
58	Frequency Deceleration Detection	Freq. Decel to	ON: Output Frequency < Frequency Command – parameter 03-14 in deceleration	○	○	○	○	○	○	○
59	Over-Temperature Detection	OH Detect	ON: Heat Sink Temperature >08-46, hysteresis Zone 08-47	○	○	○	○	○	○	○

**03-1X=0:** During Running

OFF	Run command is OFF and the inverter is stopped.
ON	Run command is ON or output frequency is greater than 0.

**03-1X=1:** Fault contact output

Output is active during fault condition.

**Note:** Communication error (CF00, CF01) do not activate the fault contact.

**03-1X=2:** Frequency Agree

Output is active when the output frequency falls within the frequency reference minus the frequency detection width (03-14).

**03-1X=3:** Setting Frequency Agree

Output is active when the output frequency falls within the frequency detection width (03-14) of the set frequency detection level (03-13).

**03-1X=4:** Frequency detection 1

Output is active when the output frequency rises above the frequency detection level (03-13) + frequency detection width (03-14) and deactivates when the output frequency falls below frequency detection level (03-13).

**03-1X=5:** Frequency detection 2

Output is active when the output frequency is below the frequency detection level (03-13) + frequency detection width (03-14) and turns off when the output frequency falls below frequency detection level.

Refer to table 4.4.30 for the operation of frequency detection.

**03-1X=6:** Automatic restart.

Output is active during an auto-restart operation.

**03-1X=9:** Baseblock (B.B.)

Output is active when the inverter output is turned off during a Baseblock command.

**03-1X=12:** Over torque detected (Normally Open)

Output is active during an over torque detection see parameters 08-13 ~ 08-16.

**03-1X=25:** Low torque detected (Normally Open)

Output is active during low torque detection see parameters 08-17 ~ 08-20.

**03-1X=13:** Current Agree

When output current > 03-15 and output current > 03-15 duration >03-16, it is ON.

**03-1X=18:** PLC status (setting =18)

Output is active when operation command parameter (00-02) is set to 3: PLC Control.

**03-1X=19:** PLC control contact



Output is controlled by the PLC logic

**03-1X=20: Zero-speed**

Output is active during zero-speed

Active	Output frequency $\leq$ minimum output frequency (01-08, Fmin)
Off	Output frequency $\geq$ the minimum output frequency

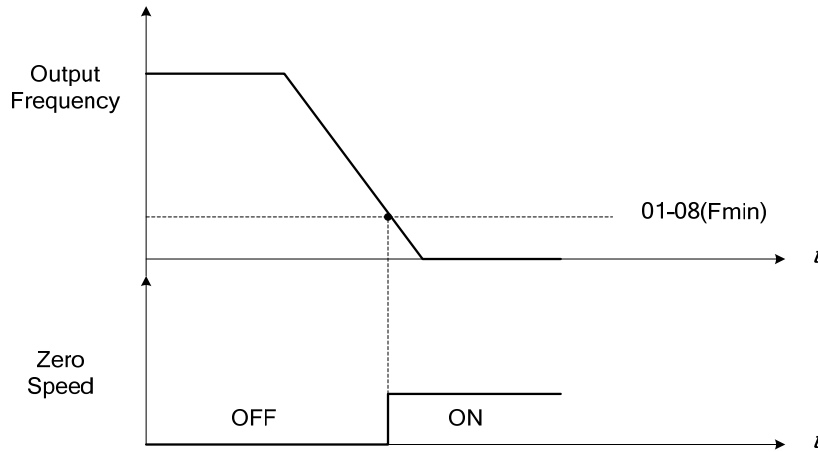

**Figure 4.4.26 Zero-speed operation**

**03-1X=21: Inverter Ready**

Output is active when no faults are active and the inverter is ready for operation.

**03-1X=22: Under voltage Detection**

Output is active when the DC bus voltage falls below the low voltage detection level (07-13).

**03-1X=23: Source of operation command**

Output is active in local operation command.

<b>OFF</b>	Remote mode: 00-02 = 1 or 2, or any one of the multi-function digital input terminals (S1 to S8) set to function 5 (LOCAL / REMOTE control) is OFF. SEQ LED of the keypad is ON.
<b>ON</b>	Local mode: 00-02 = 0, or any one of the multi-function digital input terminals (S1 to S8) set to function 5 (LOCAL / REMOTE control) is active. SEQ LED of the keypad is OFF.

**03-1X=24: Source of frequency command**

Output is active in local frequency command.

<b>OFF</b>	Remote mode: 00-05 = 1 or 2, or any one of the multi-function digital input terminals (S1 to S8) set to function 5 (LOCAL / REMOTE control) is OFF. REF LED of the keypad is ON.
<b>ON</b>	Local mode: 00-05 = 0, or any one of the multi-function digital input terminals (S1 to S8) set to function 5 (LOCAL / REMOTE control) is active. REF LED of the keypad is OFF.

**03-1X=26: Frequency reference missing**

Output is active when the frequency reference is lost. When parameter 11-41 is set to 0 the inverter will decelerate to a stop. When parameter 11-41 is set to 1 operation will continue at the value of parameter 11-42 times the last know frequency reference.

**03-1X=27:** Time function output

Output is controlled by timer function see parameter 03-37 and 03-38.

**03-1X=28:** Traverse operation UP status

Output is controlled by frequency wobbling operation; refer to Parameter group 19 for details.

**03-1X=29:** During Traverse operation status

Output is controlled by the acceleration period or frequency wobbling operation, refer to Parameter group 19 for details.

**03-1X=30:** Motor 2 selected

Output is active when motor 2 is selected.

**03-1X=31:** Zero Servo Status (Position mode)

Output is active when Zero-servo operation is enabled and the load is locked into position.

**03-1X=32:** Communication control contacts

Communication location: 2507H,control by RY3 RY2 RY1.RY3 and RY2 will execute if DO1,DO2 and DO3 all set communication control, and 2507H set 5(101)

**03-1X=37:** PID Feedback Loss Detection Output

When PID feedback loss occurs (refer to the setting of parameters 10-11~10-13), it performs the state of ON.

**03-1X=38:** Brake Release

The state of ON means release brake is active. Refer to parameters 03-41~03-42 for the details.

**03-1X=39:** Frequency Detection 1 (dedicated for Crane)

**03-1X=40:** Frequency Output

Refer to Table 4.4.30 for the operation of frequency detection.

**03-1X=41:** Position Agree (Position Mode)

Position search is completed at position mode, then ON.

**03-1X=45:** PID Sleep

It will inform when PID sleep ON.

**03-1X=50:** Frequency Detection 3

Please refer to Table 4.4.9 Frequency detection operation

**03-1X=51:** Frequency Detection 4

Please refer to Table 4.4.9 Frequency detection operation

**03-1X=52:** Frequency Detection 5

Please refer to Table 4.4.9 Frequency detection operation

**03-1X=53:** Frequency Detection 6

Please refer to Table 4.4.30 Frequency detection operation

**03-1X=54:** Turn on short-circuit braking

Output terminal is closed when Turning on short-circuit braking

**03-1X=57:** Low Current Detection

When output current  $\leq$ 03-48, relay is active.

**03-1X=58: Frequency Deceleration Detection**

When output frequency < frequency command- 03-14 in deceleration, the relay is active. Please refer to Table 4.3.30 Frequency detection operation

**03-1X=59: Over Temperature Detection**

The Heat Sink Temperature > 08-46, the relay is active, the Magnetic Hysteresis Zone is set by 08-47.

<b>03-13</b>	<b>Frequency detection Level</b>
<b>Set Range</b>	0.0~599.0 Hz

<b>03-14</b>	<b>Frequency detection width</b>
<b>Range</b>	0.1~25.5 Hz

Frequency detection Level: set the multi-function output terminals R1A-R1C, R2A-R2C or PH1 (03-11, 03-12 or 03-28) to the desired detection level and bandwidth for use with multi-function output functions 2 to 5.

The time charts for the Frequency Agree Detection operation are shown in the following table 4.4.9.

<b>03-44</b>	<b>Frequency Detection Level 2</b>
<b>Range</b>	0.0~599.0 Hz

<b>03-45</b>	<b>Frequency Detection Width 2</b>
<b>Range</b>	0.1~25.5 Hz

<b>03-46</b>	<b>Frequency Detection Level 3</b>
<b>Range</b>	0.0~599.0 Hz

<b>03-47</b>	<b>Frequency Detection Width 3</b>
<b>Range</b>	0.1~25.5 Hz

<b>03-50</b>	<b>Frequency Detection Level 4</b>
<b>Range</b>	0.0~599.0 Hz

<b>03-51</b>	<b>Frequency Detection Level 5</b>
<b>Range</b>	0.0~599.0 Hz

<b>03-52</b>	<b>Frequency Detection Level 6</b>
<b>Range</b>	0.0~599.0 Hz

**Frequency Detection** : Set R1A-R1C、R2A-R2C or PH1 (03-11, 03-12 or 03-28) to output frequency signal and then set frequency confirmation and output frequency detection 1~6.

Please refer to table 4.4.30.detection operation of frequency time block

**Table 4.4.30 Frequency detection operation**

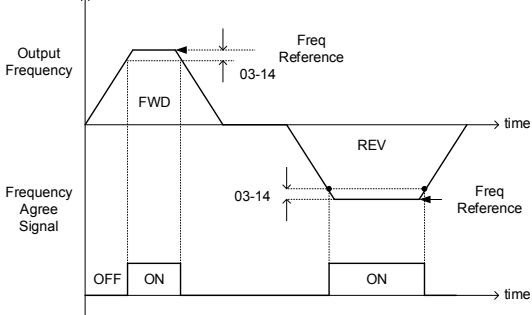
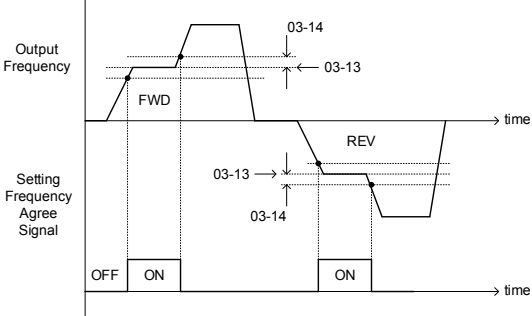
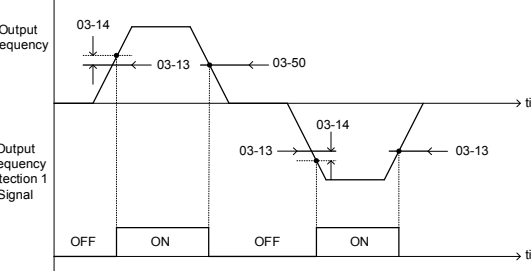
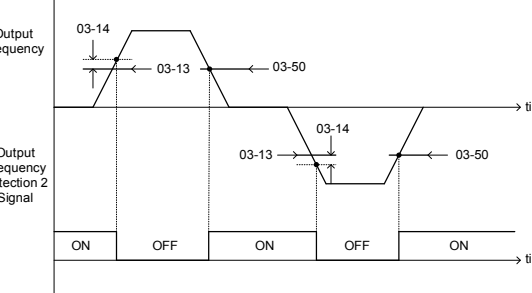
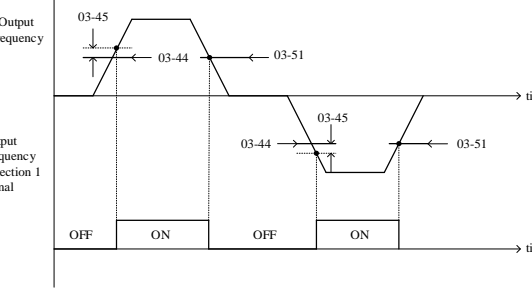
Function	Detection operation of frequency confirmation	Description
<p>Frequency agree</p>		<p>Output is active when the output frequency falls within the frequency reference minus the frequency detection width (03-14).</p> <p>Any of the digital outputs function (03-11, 03-12 or 03-28) can be set to 2 (Frequency agree).</p>
<p>Set frequency agree</p>		<p>Output is active the output frequency falls within the frequency detection width (03-14) of the set frequency detection level (03-13).</p> <p>Any of the digital outputs function (03-11, 03-12 or 03-28) can be set to 3 (Set frequency agree).</p>
<p>Output frequency detection 1</p>		<p>Output is active when the output frequency rises above the frequency detection level (03-13) + frequency detection width (03-14) and deactivates when the output frequency falls below frequency detection level 4 (03-50).</p> <p>Any of the digital outputs function (03-11, 03-12 or 03-28) can be set to 4 (Output frequency detection 1).</p>
<p>Output frequency detection 2</p>		<p>Output signal is OFF when the output frequency rises above the frequency detection level (03-13) + frequency detection level width (03-14) and turns ON when the output frequency falls below the frequency detection level 4 (03-50).</p> <p>Any of the digital outputs function (03-11, 03-12 or 03-28) can be set to 5 (Output frequency detection 2).</p>
<p>Output frequency detection 3</p>		<p>Output is active when the output frequency rises above the frequency detection level 2 (03-44) + frequency detection width 2 (03-45) and deactivates when the output frequency falls below frequency detection level 5(03-51).</p> <p>Any of the digital outputs function (03-11, 03-12 or 03-28) can be set to 50 (Output frequency detection 3).</p>

Function	Detection operation of frequency confirmation	Description
Output frequency detection 4		<p>Output signal is OFF when the output frequency rises above the frequency detection level 2 (03-44) + frequency detection width 2 (03-45) and turns ON when the output frequency falls below frequency detection level 5 (03-51).</p> <p>Any of the digital outputs function (03-11, 03-12 or 03-28) can be set to 51 (Output frequency detection 4).</p>
Output frequency detection 5		<p>Output is active when the output frequency rises above the frequency detection level 3 (03-46) + frequency detection width 3 (03-47) and deactivates when the output frequency falls below frequency detection level 6 (3-52).</p> <p>Any of the digital outputs function (03-11, 03-12 or 03-28) can be set to 52 (Output frequency detection 5).</p>
Output frequency detection 6		<p>Output signal is OFF when the output frequency rises above the frequency detection level 3 (03-46) + frequency detection width 3 (03-47) and turns ON when the output frequency falls below frequency detection level 6 (3-52).</p> <p>Any of the digital outputs function (03-11, 03-12 or 03-28) can be set to 53 (Output frequency detection 6).</p>
Output Frequency Detection 1 (dedicated for Crane)		<p>If the output frequency &gt; frequency detection level (03-13) + frequency detection width (03-14) during acceleration, signal of output frequency detection 1 (dedicated for Crane) is ON.</p> <p>If the output frequency &lt; frequency detection level 4 (03-50) during deceleration, signal of output frequency detection 1 (dedicated for Crane) is OFF.</p> <p>Set any parameters 03-11, 03-12 or 03-28 to 39 (output frequency detection – dedicated for Crane).</p>
Frequency Output		<p>When the inverter output frequency is active, the output terminal is closed.</p>

Function	Detection operation of frequency confirmation	Description
Frequency Deceleration Detection		<p>The Output Signal is ON, when the Frequency decelerates and the output frequency is outside the range of Frequency Reference <math>\pm</math> Frequency Detection Width (03-14), Set the parameter of 03-11, 03-12 or 03-28 to 58 (Frequency Deceleration Detection).</p>

<b>03-15</b>	<b>Current Agree Level</b>
<b>Range</b>	0.1~999.9 A
<b>03-16</b>	<b>Delay Time of Current Agree Detection</b>
<b>Range</b>	0.1~10.0 Sec
<b>03-53</b>	<b>Current Agree Level 2</b>
<b>Range</b>	0.0~999.9 A

Note: The Maximum Value of 03-53 will be limited by Setting Value of 03-15

**03-11=13**, then,

When the output current >03-15, relay is active.

**03-15:** The suggested setting value is 0.1~ the motor rated current.

**03-16:** The delay time performs depending on the setting value. In addition, when the Output Current is  $\leq$  03-53, the delay time from ON to OFF in the signal of relay is 100ms (constant).

**Time Diagram:**

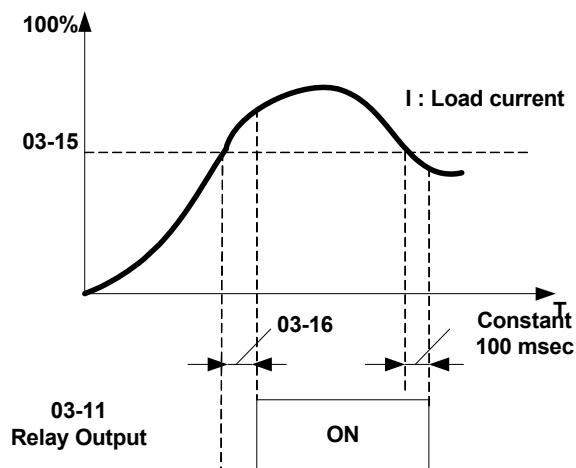

<b>03-48</b>	<b>Low Current Detection Level</b>
<b>Range</b>	<b>【0.0~999.9】 A</b>
<b>03-49</b>	<b>Low Current Detection Delay Time</b>
<b>Range</b>	<b>【0.00~655.34】 Sec</b>

03-11 set to 57: When output current  $\leq$  03-48 (Low current detection level), the relay works.  
 When 03-48 set 0.0, low current detection function disabled.  
 If the detection time is bigger than the setting time of 03-49, the relay works.  
 Besides, the relay delay time from ON to OFF is 100ms, and it's fixed.

The timing chart:

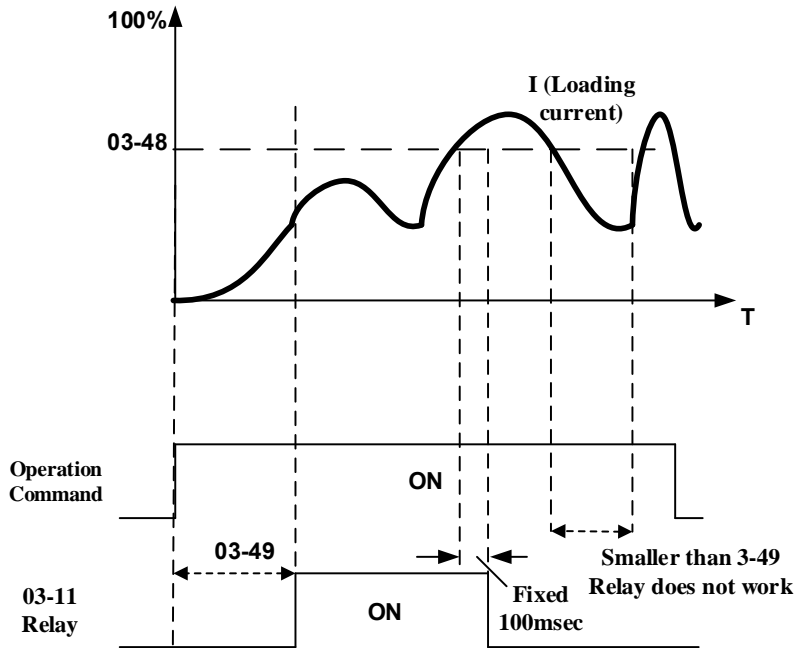

<b>03-17</b>	<b>Mechanical Braking Release Level</b>
<b>Range</b>	0.00~599 Hz

<b>03-18</b>	<b>Mechanical Braking Level Set</b>
<b>Range</b>	0.00~599 Hz

When 03-11=14, the real frequency equal to the value of 03-17 (Mechanical Braking Release Level) in acceleration time, the relay output will execute.

When 03-11=14, the real frequency equal to the value of 03-18 (Mechanical Braking Level Set) in deceleration time, the relay output will stop execute.

When  $03-17 \leq 03-18$ , the timing diagram is as follows:

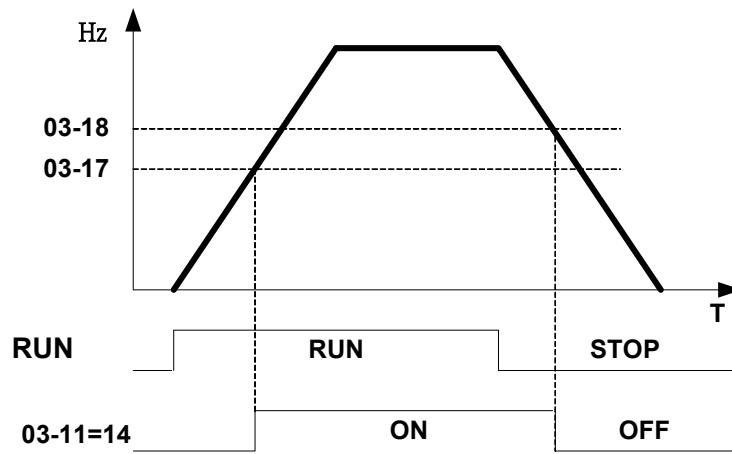

When  $03-17 \geq 03-18$ , the timing diagram is as follows::

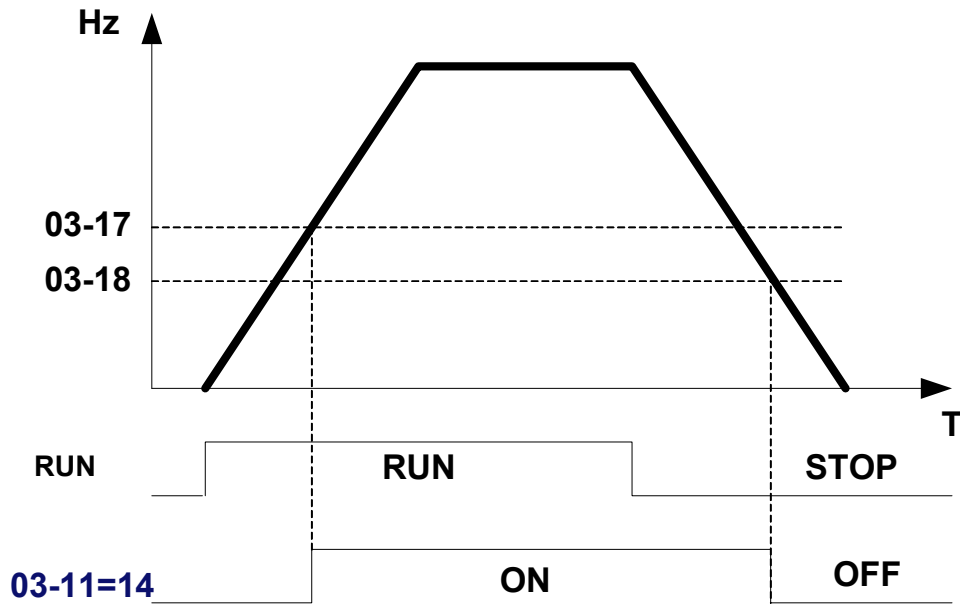



03-19	Relay (R1A-R2C) type
Range	xxx0b: R1 A contact    xxx1b: R1 B contact xx0xb: R2 A contact    xx1xb: R2 B contact 0xxxb: R4 A contact    1xxxb: R4 B contact

Parameter 03-19 selects the digital output type between a normally open and a normally closed contact.

Each bit of 03-19 presents an output :

03-19= 0 0      0: normally open contact  
          R2 R1      1: normally close contact

**Example:** R1 normally open and R2 normally closed contact set 03-19=xxx01.

03-27	UP/DOWN Frequency Hold/Adjust Selection
Range	0: Hold last set frequency when stopped 1: Set frequency to 0 when stopped 2: Allow speed changes from last set frequency when stopped 3: Refresh frequency at acceleration

**03-27=0:** When the run command is removed the UP/DOWN frequency reference before deceleration is stored. The next time the run command is applied the output frequency will ramp up to the previously stored frequency reference.

**03-27=1:** When the run command is removed the UP/DOWN frequency reference command is cleared (set to 0). The next time the run command is applied the output frequency will start at 0.

**03-27=2:** UP/DOWN command is active when run command is not active.

**03-27=3:** Keep the state of frequency command not to be cleared. When run command re-sends, press UP/DOWN key before the run frequency reaches the frequency command.

03-40	Up/Down Frequency Width Setting
Range	0.00~5.00 Hz

When 03-40 is set to 0 Hz, Up / Down function is maintained.

When 03-40 is not set to 0 Hz, frequency command is set by the run frequency plus the setting frequency of 03-40.

Example: set terminal S1: 03-00=8 (Up increased frequency command), terminal S2: 03-01=9 (Down decreased frequency command) and 03-40= ΔHz.

Mode 1: When 03-40 is set to 0 Hz, Up / Down function is maintained. Refer to Fig. 4.4.20.

Mode 2: When 03-40 is not set to 0 Hz and terminals conduction time < 2 Sec, frequency change (ΔHz) at one conduction occurs depending on the setting of 03-40.

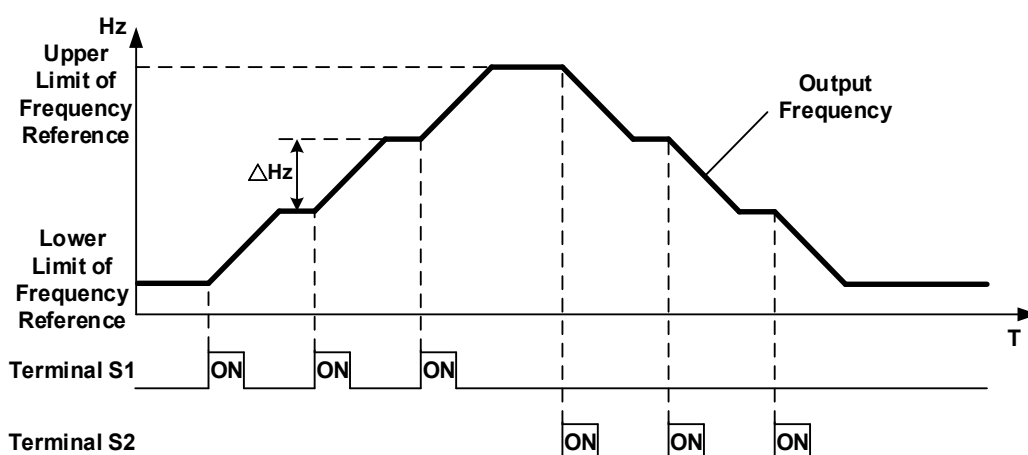

Mode 3: When 03-40 is not set to 0 Hz and terminals conduction time > 2 Sec, frequency changes upon general acceleration/ deceleration.

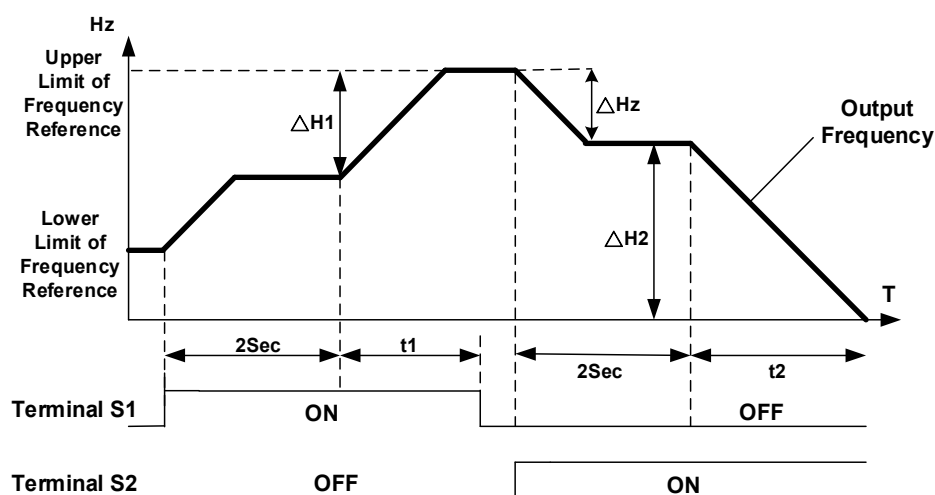

※Descriptions:

**ΔH1**: frequency increment setting at acceleration, **t1**: terminal conduction time at acceleration,  
**ΔH2**: frequency increment setting at deceleration, **t2**: terminal conduction time at deceleration.

$$\Delta H1 = \frac{\text{Upper Limit Frequency}}{\text{Acceleration Time 2}} \times \text{Terminal Conduction Time (t1)}$$

$$\Delta H2 = \frac{\text{Upper Limit Frequency}}{\text{Deceleration Time 2}} \times \text{Terminal Conduction Time (t2)}$$

<b>03- 28</b>	<b>Photo-coupler Output (DO1-DOG)</b>
<b>03- 21</b>	<b>Photo-coupler Output 2(DO2-DOG2)</b>
<b>Range</b>	See function selection list parameter 03-11, 03-12

<b>03-29</b>	<b>Photo-coupler Output Selection (DO1-DOG)</b>
<b>Range</b>	xxx0b: Photo-coupler A Contact      xxx1b: Photo-coupler B Contact 0xxx b: Photo-coupler 2 A Contact      1xxx b: Photo-coupler 2 B Contact

0 = Normally open (A), 1 = Normally closed (B)

03- 30	Function setting of pulse input
Range	0: General Pulse Input 1: PWM

There are two ways for pulse input selection:

(1) General pulse input:

PI= cutoff frequency divided by pulse input scale set by 03-31, corresponding to the maximum output frequency of motor 1 (01-02).

Monitoring parameter 12-79 (pulse input percentage) is the proportional relationship between input signal and pulse input scale of 03-31.

(2) PWM: It is required to input the correct frequency.

PWM= Time of positive edge pulse divided by the time period of pulse, corresponding to the maximum output frequency of motor 1 (01-02).

Monitoring parameter 12-79 (pulse input percentage) is the proportional relationship between the positive edge terminal of input signal and time period.

**Note:** Deviation of pulse time period in PWM is  $\pm 12.5\%$ . If it is over the deviation range, pulse input is not active.

Diagram for pulse input selection:

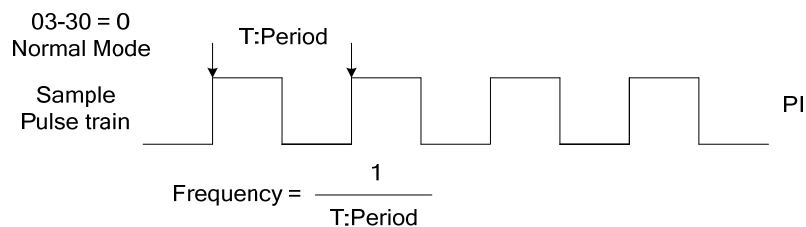

$$\text{Pulse Input Command} = \frac{\text{Frequency}}{\text{Scaling factor (using 03-31)}} \times 100\%(01-02)$$

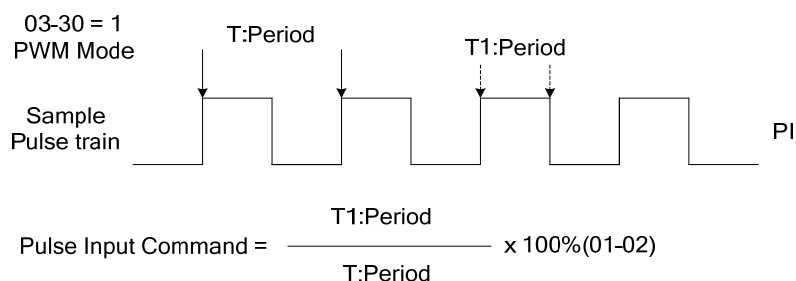

<b>03-31</b>	<b>Scale of pulse input</b>
<b>Range</b>	Depending on the setting of 03-30 03-30=0: 50~32000Hz 03-30=1: 10~1000Hz

Pulse input scaling, 100% = Maximum pulse frequency.

<b>03-32</b>	<b>Pulse input gain</b>
<b>Range</b>	0.0~1000.0 %

Target value (03-03) in % = Pulse input frequency scaled to 100% based on maximum pulse frequency (03-31) times the gain (03-32) + bias (03-33).

<b>03-33</b>	<b>Pulse input bias</b>
<b>Range</b>	-100.0~100.0 %

Target value (03-03) in % = Pulse input frequency scaled to 100% based on maximum pulse frequency (03-31) times the gain (03-32) + bias (03-33).

<b>03-34</b>	<b>Pulse input filter time</b>
<b>Range</b>	0.00~2.00 Sec

- \* Refer to section 3.9 control circuit terminals for details.
- \* Refer to figure 4.4.27 for the pulse input specification.

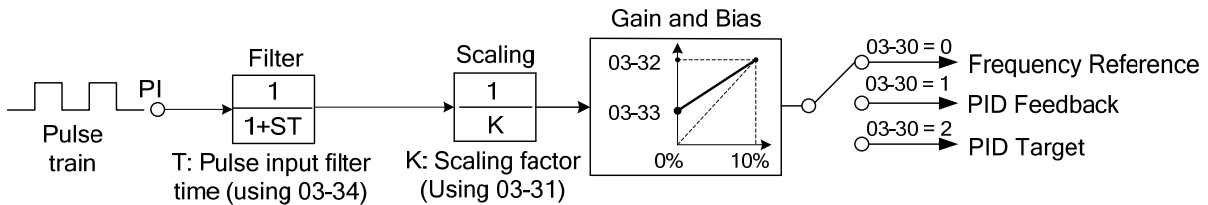

**Figure 4.4.27 Pulse input adjustment**

### Set Pulse Input Setup as Frequency Reference

Set parameter 00-05 to 4 and 03-30 to 0 to use the pulse input terminal PI as the frequency reference source. Refer to Figure 4.3.5. for details. Next set the pulse input scaling (03-31), enter the pulse input frequency to match the maximum output frequency. Adjust the pulse input filter time in case interference or noise is encountered.

**Example:** Pulse train input maximum 10 kHz, set parameter 03-31 to 10000 when maximum frequency is set to 60.0Hz.

### Set Pulse Input as PID feedback value

Set parameter 00-05 to 5, 03-30 to 1 and PID feedback value source 10-01 to 3, to use the pulse input terminal PI as the PID target (setpoint) value. Next set the pulse input scaling (03-31), enter the pulse input frequency to match the maximum output frequency. Adjust the pulse input filter time in case interference or noise is encountered. Refer to Figure 4.4.28. for details.

**Note:** The inverter will display a SE09 "PI setting error" when 03-30 = 1 and 10-01 is not set to 3.

### Set Pulse Input as PID target value

Set parameter 00-05 to 5 and 03-30 to 2 to use the pulse input terminal PI as the PID target (setpoint) value. Next set the pulse input scaling (03-31), enter the pulse input frequency to match the maximum output frequency. Adjust the pulse input filter time in case interference or noise is encountered. Refer to Figure 4.4.28 for details.

**Note:** The inverter will display a SE09 "PI setting error" if 03-30=0 and PID control is enabled (10-03 > 0).

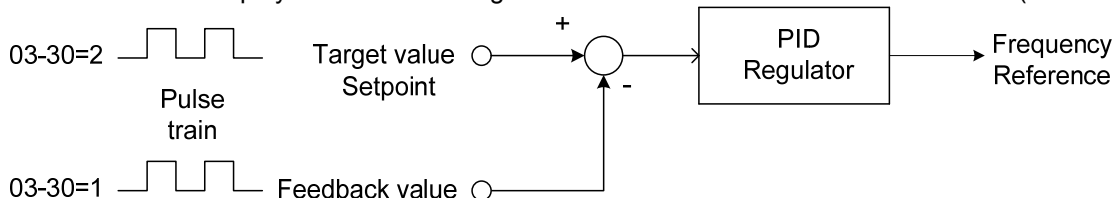

**Figure 4.4.28 PID control**

03-35	Function setting of pulse output
<b>Range</b>	1: Frequency command 2: Output frequency 3: Output frequency after the soft start 4: Motor speed 5: PID feedback 6: PID input 7: PG output (with PG card)

Refer to Table 4.4.10 for pulse output function selection overview.

03-36	Scale of pulse output
<b>Range</b>	1~32000 Hz

Pulse output scaling, 100% = Maximum pulse frequency (see table 4.4.10).

**Note:** When setting 03-35 to 2 (output frequency) and setting 03-36 to 0 (0 Hz), PO's pulse output and the inverter output frequency are sync.

**Table 4.4.31 Pulse output function selection**

03-35	Function	Screen display (LCD)	Parameter	100%
1	Frequency command	Freq Ref	12-16	01-02
2	Output frequency (Fout)	Output Freq	12-17	01-02
3	Output frequency after soft-start	Output Freq (SFS)	-	01-02
4	Motor speed (rpm)	Motor Speed	12-22	01-02
5	PID feedback	PID Feedback	12-39	01-02
6	PID input	PID Input	12-36	01-02
7	PG output	PG Pulse Output		

**Note:** Selection 1~4 are related to the motor speed, 5 and 6 are related to PID and 7 is related to PG.

**Setup the pulse output**

Use 03-36 (pulse output scale) to set the pulse output frequency to 100% signal value of the selected item.

Please refer to the figure 4.4.29.

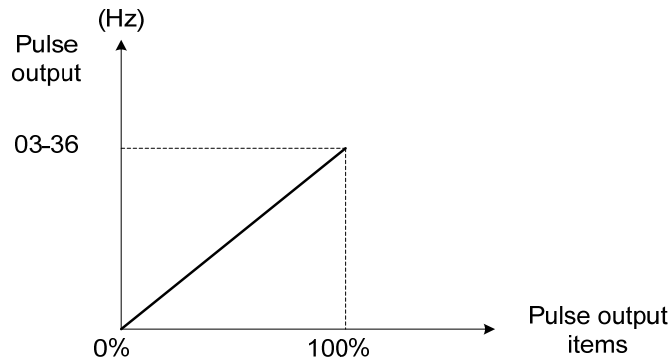

**Figure 4.4.29 Pulse output proportion**

When setting 03-35 to 2 (output frequency), PO's pulse output and the inverter output frequency are sync. Scale of pulse output is equal to the value of 03-36.

For the pulse output signal level, please refer to figure 4.4.30.

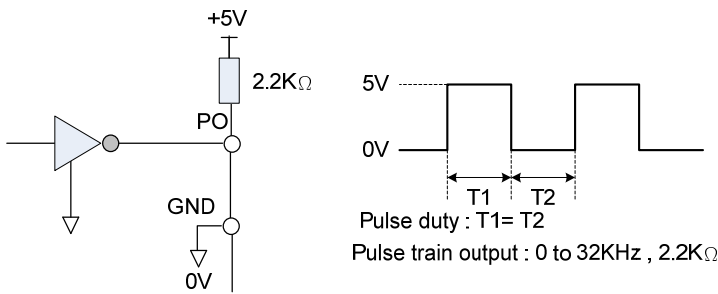

**Figure 4.4.30 Pulse output signal level**

When 03-35 = 7 (PG pulse monitoring output), PG pulse output scaling is internally set 1:1, independent of the scaling set in parameter 03-36.

**Note:** When pulse output function is active, it is required to use the external pull-up resistor at the terminal of PO (the upper limit current of PO is 50mA and 48V)

**Application examples**

**Example A: Speed follower from external PG**

Use the pulse input signal as frequency reference or synchronization operation. Refer to Fig. 4.4.31.

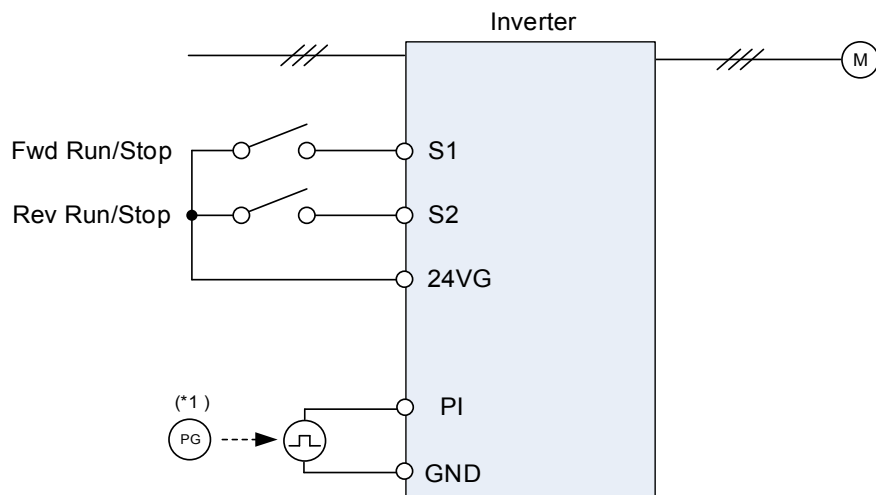

**Figure 4.4.31 Speed follower from external PG**

**Parameter settings:**

1. Frequency reference selection: 00-05=4 (Pulse input)
2. Pulse input's function selection: 03-30=0 (General pulse input)
3. Pulse input scale: 03-31 (set the number of pulse in Hz to match maximum output frequency, 01-02)
4. Pulse input gain: 03-32 (Set the input gain of the pulse frequency set by 03-31 )
5. Pulse input bias: 03-33 (Set the input bias of the pulse frequency set by 03-31)
6. Pulse input's filter time: 03-34 (if the pulse input is unstable due to the interference, increase value.)

Use the forward and reverse multi-function inputs to choose motor direction.

**Note:** For higher accuracy use PG feedback in SV or V / f + PG control mode.

**Example B:** Speed follower using two inverters

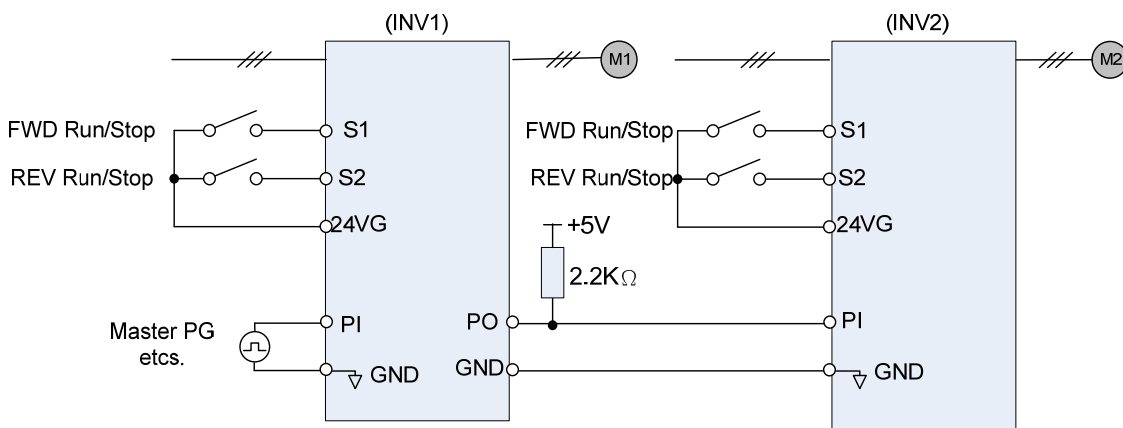

**Figure 4.4.32 Speed follower using two inverters**

**Inverter #1 parameter settings: Frequency reference from PI signal (Master PG)**

1. Frequency reference selection: 00-05=4 (Pulse input)
2. Pulse input's function selection: 03-30=0 (General pulse input)
3. Pulse input scale: 03-31 (set the number of pulse in Hz to match maximum output frequency, 01-02)
4. Pulse input gain: 03-32 (Set the input gain of the pulse frequency set by 03-31 )
5. Pulse input bias: 03-33 (Set the input bias of the pulse frequency set by 03-31)

6. Pulse input's filter time: 03-34 (if the pulse input is unstable due to the interference, increase value.)
7. Pulse output function selection: 03-35=2 (Pulse output is output frequency)
8. Scale pulse output parameter 03-36 to 100% of output frequency

**Inverter #1 parameter settings: Frequency reference from analog signal**

1. Frequency reference selection: 00-05=1 (Analog input)
2. Pulse output function selection: 03-35=2 (Pulse output is output frequency)
3. Scale pulse output parameter 03-36 to 100% of output frequency

**Inverter #2: parameter settings:**

1. Frequency reference selection: 00-05=4 (Pulse input)
2. Pulse input's function selection: 03-30=0 (General pulse input)
3. Pulse input scale: 03-31 (set the number of pulse in Hz to match maximum output frequency, 01-02)
4. Pulse input gain: 03-32 (Set the input gain of the pulse frequency set by 03-31)
5. Pulse input bias: 03-33 (Set the input bias of the pulse frequency set by 03-31)
6. Pulse input's filter time: 03-34 (if the pulse input is unstable due to the interference, increase value.)

**Note:** When pulse output function is active, it is required to use the external pull-up resistor at the terminal of PO (the upper limit current of PO is 50mA)

**Example C:** Synchronized operation using pulse input

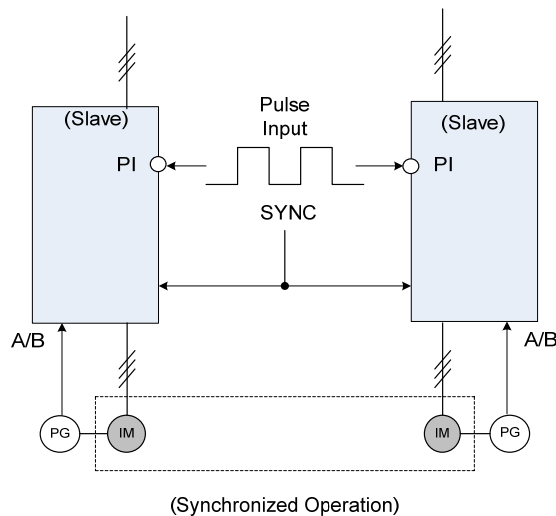

**Figure 4.4.33: Synchronized operation of using pulse input**

Connect pulse signal of an external pulse generator to the pulse input terminal PI of multiple follower inverters for output speed synchronization.

**Follow inverter #1 and Follower #2 parameter settings:**

1. Frequency reference selection: 00-05=4 (Pulse input)
2. Pulse input's function selection: 03-30=0 (General pulse input)
3. Set one of the Multi-function inputs Sn: 03-00 ~ 03-07=32 (Synchronization command)

**Example D:** Synchronized operation of using pulse output master follower



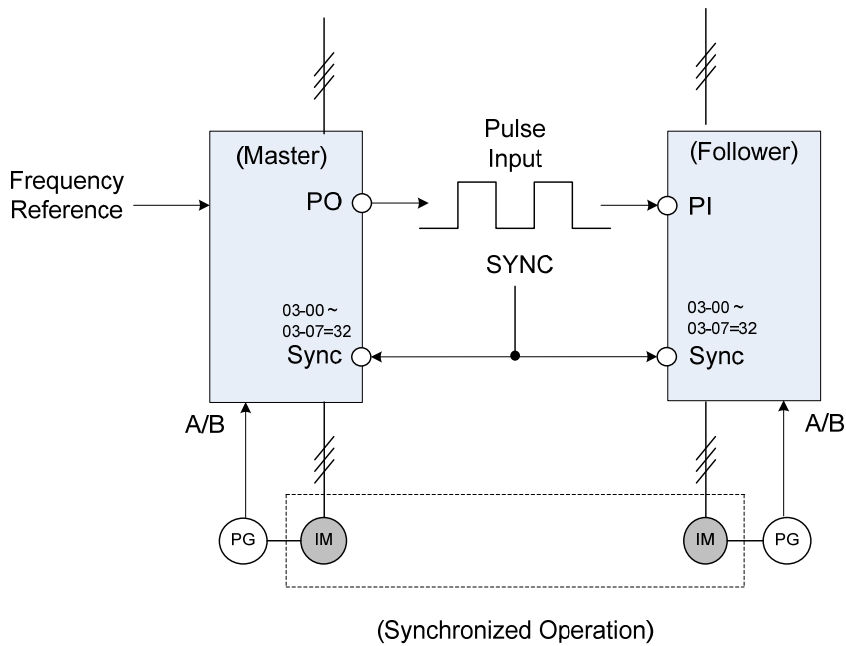

**Figure 4.4.34 Synchronized operation master follower**

**Master inverter parameter settings:**

1. Pulse output function selection: 03-35=1 (Pulse output is output frequency)
2. Scale pulse output parameter 03-36 to 100% of output frequency
3. Set one of the Multi-function inputs Sn: 03-00 ~ 03-07=32 (Synchronization command)

**Follower inverter parameter settings:**

1. Frequency reference selection: 00-05=4 (Pulse input)
2. Pulse input's function selection: 03-30=0 (Frequency command)
3. Pulse input scale: 03-31 (set the number of pulse in Hz to match maximum output frequency, 01-02)
4. Pulse input gain: 03-32 (Set the input gain of the pulse frequency set by 03-31)
5. Pulse input bias: 03-33 (Set the input bias of the pulse frequency set by 03-31)
6. Pulse input's filter time: 03-34 (if the pulse input is unstable due to the interference, increase value.)
7. Set one of the Multi-function inputs Sn: 03-00 ~ 03-07=32 (Synchronization command)

<b>03-37</b>	<b>Timer ON delay (DI/DO)</b>
<b>Range</b>	0.0~6000.0 Sec

<b>03-38</b>	<b>Timer OFF delay (DI/DO)</b>
<b>Range</b>	0.0~6000.0 Sec

Enable the timer function by setting one of multi-function input parameters 03-00~03-07 (S1 to S8) to 35 (timer function input) and one of multi-function output parameters 03-11, 03-12 (R1A-R1C to R4A- R4C and PH1 to PH4) to 27 (timer function output).

The timer function can be used to implement a timer relay. Use timing parameter 03-37 and 03-38 to set the timer ON / OFF delay.

Timer output is turned ON when the multi-function timer input is ON for the time specified in parameter 03-37.

Timer output is turned OFF after the multi-function timer input is turned OFF for the time specified in parameter 03-38.

**Timing example:**

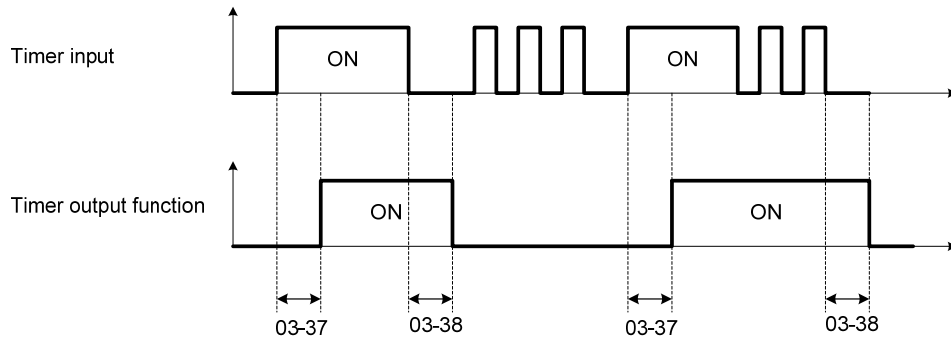

<b>03-41</b>	<b>Torque Detection Level</b>
<b>Range</b>	0~150 %
<b>03-42</b>	<b>Brake Release Delay Time</b>
<b>Range</b>	0.00~65.00 Sec

**Brake Release Function :**

It is required to be with the frequency agree function, as the following figure:

When the inverter starts running, if the output frequency > 03-13, and both frequency detection level and output torque > torque detection level (03-41), it will delay the time of 03-42 to release brake.

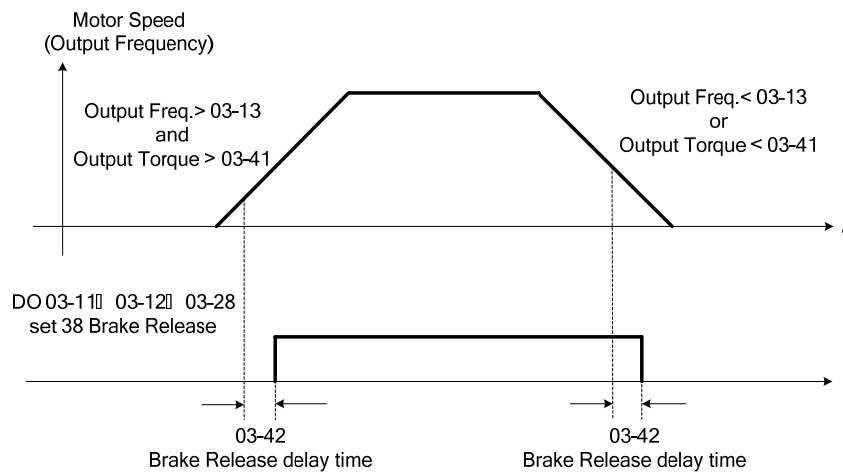

It is recommended to be with starting and stopping frequency locked function (11-43~11-46), shown as the following figure:

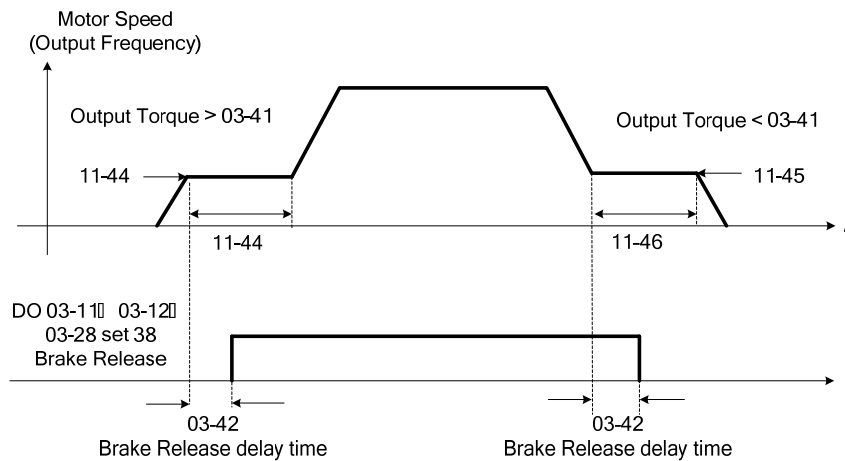

<b>03-43</b>	<b>UP/DOWN Acceleration/ Deceleration Selection</b>
<b>Range</b>	<b>【0】 : Acceleration/Deceleration Time 1</b> <b>【1】 : Acceleration/Deceleration Time 2</b>

Calculate the acceleration/ deceleration time of frequency command by switch the function of UP/DOWN from parameter 03-43. Ex:  $\Delta H1$  (set frequency increment at acceleration) and  $\Delta H2$  (set frequency increment at deceleration).

Ex 1 :

- 03-43=1(Acceleration/ Deceleration Time 2)
- Acceleration/ Deceleration Time 1 > Acceleration/ Deceleration Time 2

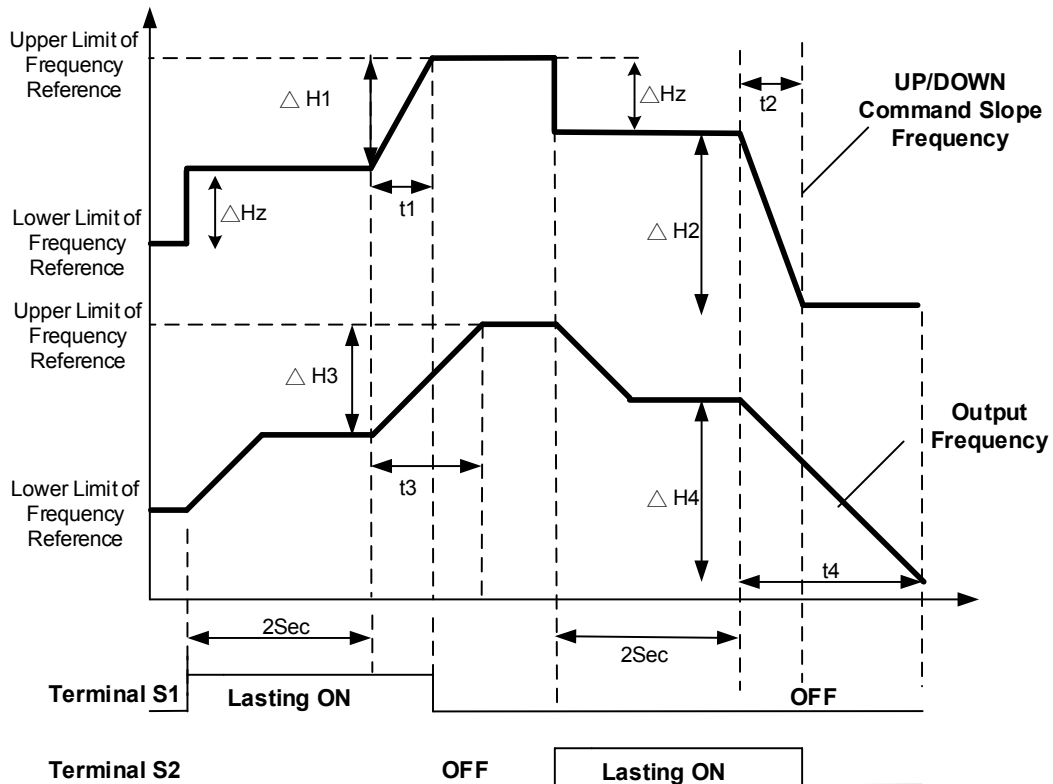

Notes:

$\Delta H1$ : Frequency augmentation setting in acceleration,  $t1$ : Terminal conduction time in acceleration

$\Delta H2$ : Frequency augmentation setting in deceleration,  $t2$ : Terminal conduction time in deceleration  
 $t3$ : Acceleration time in output  
 $\Delta H3$ : Output frequency augmentation in acceleration,  $t4$ : Deceleration time in output  
 $\Delta H4$ : Output frequency augmentation in deceleration

$$\Delta H1 = \frac{\text{Upper limit Frequency}}{\text{Acceleration Time 2}} \times t1$$

$$\Delta H3 = \frac{\text{Upper Limit Frequency}}{\text{Acceleration Time 1}} \times t3$$

$$\Delta H2 = \frac{\text{Upper limit Frequency}}{\text{Deceleration Time2}} \times t2$$

$$\Delta H4 = \frac{\text{Upper Limit Frequency}}{\text{Deceleration Time1}} \times t4$$

Ex2 :

- 03-43=1(Acceleration/ Deceleration Time 2)
- Acceleration/ Deceleration Time 1 < Acceleration/ Deceleration Time 2

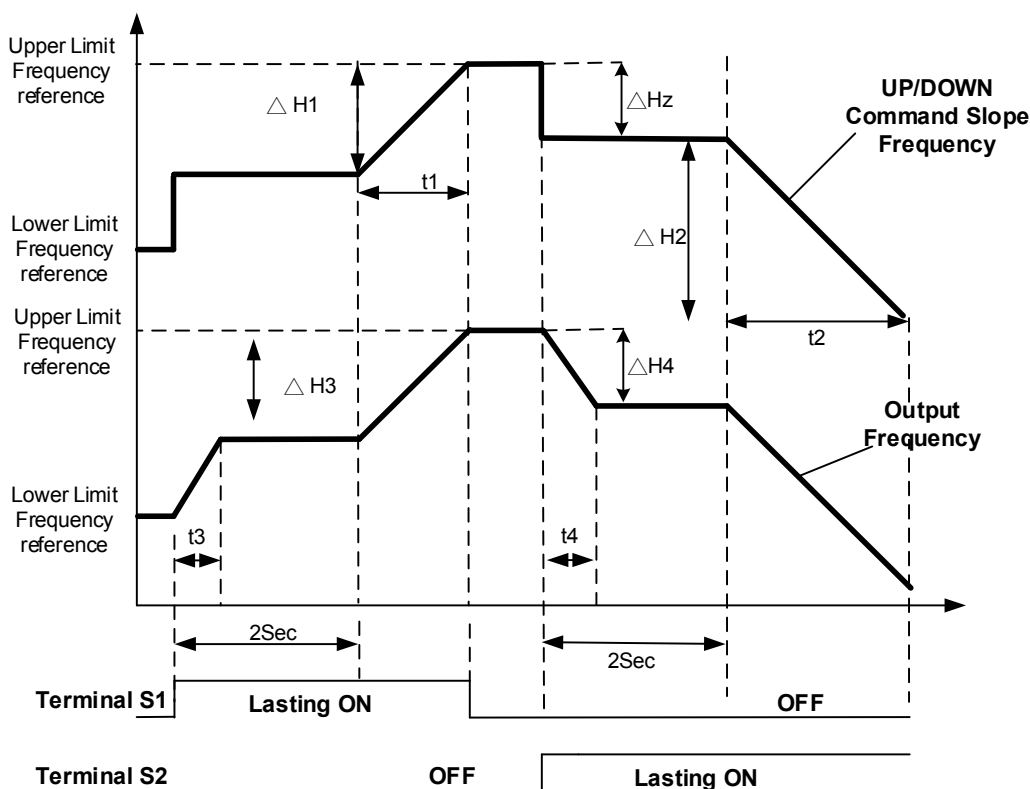

Notes:

$\Delta H1$ : Frequency augmentation setting in acceleration  $t1$ : Terminal conduction time in acceleration  
 $\Delta H2$ : Frequency augmentation setting in deceleration  $t2$ : Terminal conduction time in deceleration  
 $t3$ : Acceleration time in output  
 $\Delta H3$ : Output frequency augmentation in acceleration,  $t4$ : Deceleration time in output  
 $\Delta H4$ : Output frequency augmentation in deceleration

$$\Delta H1 = \frac{\text{Upper limit Frequency}}{\text{Acceleration Time 2}} \times t1$$
$$\Delta H2 = \frac{\text{Upper limit Frequency}}{\text{Deceleration Time2}} \times t2$$

$$\Delta H3 = \frac{\text{Upper Limit Frequency}}{\text{Acceleration Time 1}} \times t3$$
$$\Delta H4 = \frac{\text{Upper Limit Frequency}}{\text{Deceleration Time1}} \times t4$$

**04-External Analog Input / Output Parameter**

<b>04-00</b>	<b>AI input signal type</b>
<b>Range</b>	<b>0:</b> AI1: 0~10V      AI2: 0~10V <b>1:</b> AI1: 0~10V      AI2: 4~20mA <b>2:</b> AI1: -10~10V    AI2: 0~10V <b>3:</b> AI1: -10~10V    AI2: 4~20mA <b>4:</b> AI1: 4~20mA      AI2: 0~10V <b>5:</b> AI1: 4~20mA      AI2: 4~20mA
<b>04-09</b>	<b>AI Input Signal Type of I/O card</b>
<b>Range</b>	<b>0:</b> AI3:0~10V <b>1:</b> AI3:-10~10V <b>2:</b> AI3:4~20mA
<b>04-01</b>	<b>AI1 signal scanning and filtering time</b>
<b>Range</b>	0.00~2.00 Sec
<b>04-02</b>	<b>AI1 gain</b>
<b>Range</b>	0.0~1000.0%
<b>04-03</b>	<b>AI1 bias</b>
<b>Range</b>	-100~100.0%
<b>04-04</b>	<b>AI negative characteristics</b>
<b>Range</b>	<b>【0】</b> : Disable <b>【1】</b> : Enable
<b>04-05</b>	<b>AI2 function setting</b>
<b>04-10</b>	<b>AI3 Function Setting</b>
<b>Range</b>	<b>0:</b> Auxiliary frequency <b>1:</b> Frequency reference gain <b>2:</b> Frequency reference bias <b>3:</b> Output voltage bias <b>4:</b> Coefficient of acceleration and deceleration reduction <b>5:</b> DC braking current <b>6:</b> Over-torque detection level <b>7:</b> Stall prevention level during running <b>8:</b> Frequency lower limit <b>9:</b> Jump frequency 4 <b>10:</b> Added to AI1 <b>11:</b> Positive torque limit <b>12:</b> Negative torque limit <b>13:</b> Regenerative torque Limit <b>14:</b> Positive / negative torque limit <b>15:</b> Torque command/ torque limit (in speed control) <b>16:</b> Torque command/ torque compensation <b>17:</b> PTC overheat protection

<b>04-06</b>	<b>AI2 signal scanning and filtering time</b>
<b>Range</b>	0.00~2.00 Sec
<b>04-07</b>	<b>AI2 gain</b>
<b>Range</b>	0.0~1000.0%
<b>04-08</b>	<b>AI2 bias</b>
<b>Range</b>	-100.0~1000.0%
<b>04-21</b>	<b>AI3 Signal Scanning and Filtering Time</b>
<b>Range</b>	0.00~2.00 Sec
<b>04-22</b>	<b>AI3 Gain</b>
<b>Range</b>	0.0~1000.0 %
<b>04-23</b>	<b>AI3 Bias</b>
<b>Range</b>	-100.0~100.0 %

Refer to the followings for 04-00 AI input signal type:

(For standard H & C type)

If AI1 is 0~10V, set parameter 04-00 to 0 or 1.

If AI1 is -10~10V, set parameter 04-00 to 2 or 3.

If AI2 is 0~10V, set parameter 04-00 to 0 or 2 and tune SW2 on the control board to V.

If AI2 is 4~20mA, set parameter 04-00 to 1 or 3, tune SW2 on the control board to I.

(For enhanced E & G type)

If AI1 is 0~10V, set parameter 04-00 to 0 or 1, and tune SW3 on the control board to V.

If AI1 is -10~10V, set parameter 04-00 to 2 or 3, and tune SW3 on the control board to V.

If AI1 is 4~20mA, set parameter 04-00 to 4 or 5, and tune SW3 on the control board to I.

If AI2 is 0~10V, set parameter 04-00 to 0 or 2 or 4, and tune SW4 on the control board to V.

If AI2 is 4~20mA, set parameter 04-00 to 1 or 3 or 5, tune SW4 on the control board to I.

**(1) Analog Input Level Adjustment AI1, AI2 (04-02, 04-03, 04-04, 04-07, 04-08)**

Each analog input AI1 and AI2 has a separate gain and bias parameter associated with it.

Analog input signal AI1 can be adjusted with parameter 04-02 and 04-03; Analog input signal AI2 can be adjusted with parameter 04-07 and 04-08. Refer to Figure 4.4.35.

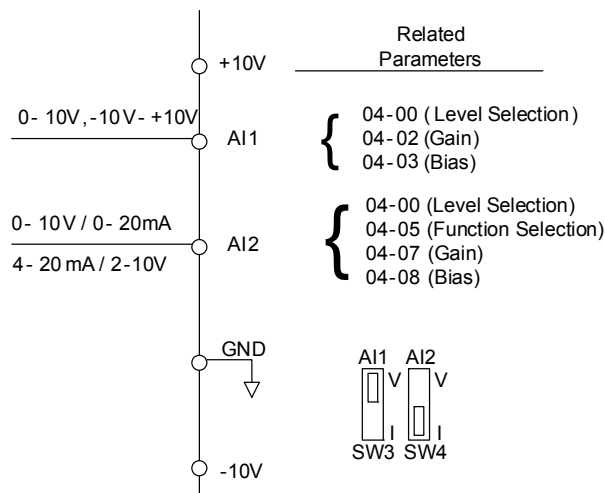

**Figure 4.4.35 Analog inputs and related parameters (for E & G type)**

**Gain setting:** Sets the level in % that corresponds to a 10V, -10V or 20mA signal at the analog input.  
 (Set the maximum output frequency 01-02 to 100 %)  
**Bias setting:** Sets the level in % that corresponds to a 0V or 4mA signal at the analog input.  
 (Set the maximum output frequency 01-02 to 100%)

Use both gain and bias setting to scale the input signal.

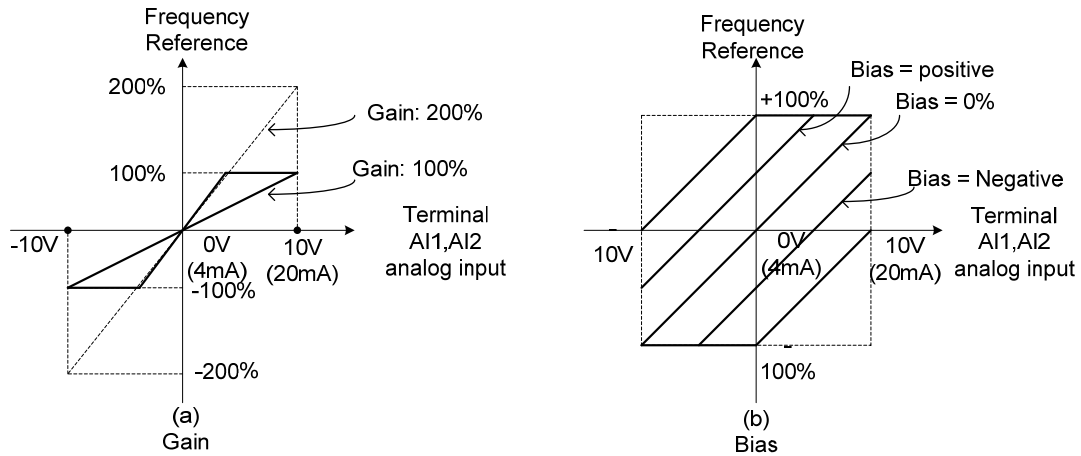

**Figure 4.4.36 Gain and bias operations (for frequency reference signal)**

**04-04 (AI negative characteristics)**

Through the following figure negative characteristics diagram find out the AI Input 10V, -10V, or 20mA input relative frequency reference to be used for the ratio of maximum output frequency (set the maximum output frequency 01-02 to 100%), the ratio will be presented in reverse.

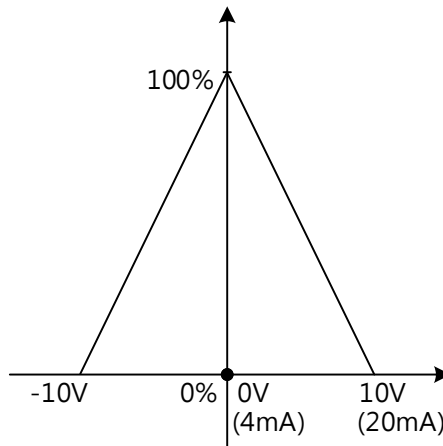

(2) AI1 signal filtering time (04-01)

(3) AI2 signal filtering time (04-06)

All analog inputs (AI1, AI2) have a 1<sup>st</sup> order programmable input filter that can be adjusted when noise is present on each of the incoming analog signal to prevent erratic drive control.

The filter time constant (range: 0.00 to 2.00 seconds) is defined as the time that the input step signal reaches 63% of its final value.



**Note:** Increasing the filter time causes the drive operation to become more stable but less responsive to change to the analog input.

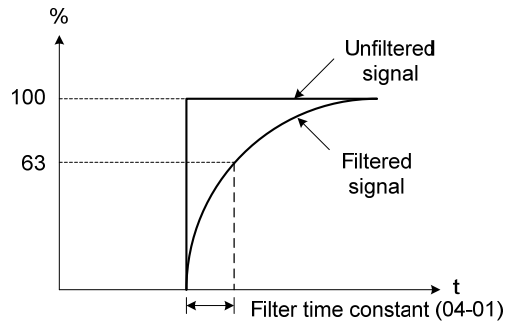

**Figure 4.4.37 Filter time constant**

**(4) AI2 function setting (04-05)**

AI2 is multi-function analog input terminal function selection. Refer to Table 4.4.11 for function overview.

**Table 4.4.32 Multi-function analog input list (04-05 setting)**

Setting	Function		Description	Control mode						
	Name	Screen display		V/F	V/F + PG	SLV	SV	PM SV	PM SLV	SLV2
0	Auxiliary frequency	AUX.Freq Ref	Max output frequency (01-02, Fmax) = 100%	○	○	○	○	○	○	○
1	Frequency reference gain (FGAIN)	Freq Ref Gain	Aggregated gain = AI1 = 04-02 * FGAIN	○	○	○	○	○	○	○
2	Frequency reference bias (FBIAS)	Freq Ref Bias	Aggregated bias = AI1 = 04-03 * FBIAS	○	○	○	○	○	○	○
3	Output voltage bias (VBIAS)	Output Volt Bias	Aggregate output voltage = V/F curve voltage + VBIAS	○	○	X	X	○	○	○
4	Coefficient of acceleration and deceleration reduction (K)	Tacc/Tdec Scaling	Actual acceleration and deceleration time = acceleration and deceleration time	○	○	○	○	○	○	○
5	DC braking current	DC Inj Current	Adjust the DC braking current (0 ~ 100%) based on analog input. When the inverter rated current = 100%, DC braking current 07-07 is disabled.	○	○	○	X	○	X	○
6	Over-torque detection level	Over Tq Level	Change over-torque detection level based on over-torque detection level, at this time, 08-15 is disabled.	○	○	○	○	○	○	○
7	Stall prevention level during running	Run Stall Level	Adjust the action level (30% ~ 200%) of stall prevention in operation based on analog input. The inverter rated current = 100%.	○	○	X	X	○	X	○

Setting	Function		Description	Control mode						
	Name	Screen display		V/F	V/F + PG	SLV	SV	PM SV	PM SLV	SLV2
8	Frequency lower limit	Ref. Low Bound	Adjust the lower limit (0 to 100%) of frequency command based on analog input, the maximum output = 100%. The lower limit of frequency command is the greater one of the actual frequency command's lower limit 00-13 or the multi-function analog input.	○	○	○	○	○	○	○
9	Jump frequency 4	Jump Freq 4	Jump frequency 4. 100% = maximum output frequency	○	○	○	○	○	○	○
10	Added to AI1	Add to AI1	Added to AI1. 100% = maximum output frequency	○	○	○	○	○	○	○
11	Positive torque limit	Positive Tq Limit	100% = motor's rated torque	X	X	○	○	○	○	X
12	Negative torque limit	Negative Tq Limit	100% = motor's rated torque	X	X	○	○	○	○	X
13	Regenerative torque limit	Regen. Tq Limit	100% = motor's rated torque	X	X	○	○	○	○	X
14	Positive / negative torque limit	+/- Tq Limit	100% = motor's rated torque	X	X	○	○	○	○	X
15	Torque command/ torque limit for speed control	Tref/Tq Limit	100% = motor's rated torque	X	X	X	○	○	X	X
16	Torque command/ torque compensation	Tq Compensation	100% = motor's rated torque	X	X	X	○	○	X	X
17	PTC overheat protection	PTC overheat Stall	Use the PTC sensor in the motor to stop from overheats.	○	○	○	○	○	○	○

**04-05=0:** Auxiliary frequency

When parameter 00-05 = 1 (main frequency from external control) the auxiliary speed reference frequency can be activated via the multi-speed input commands (see table 4.4.7). The auxiliary frequency command can be set via AI2. The maximum output frequency is set by 01-02,  $F_{max} = 100\%$ .

**04-05=1:** Frequency reference gain (FGAIN)

Multi-function analog input AI2 can be used to adjust the frequency reference gain of analog input AI1. The total frequency reference gain of terminal AI1 is the internal gain set by parameter 04-02 times FGAIN. The maximum frequency reference for AI1 is 100%.

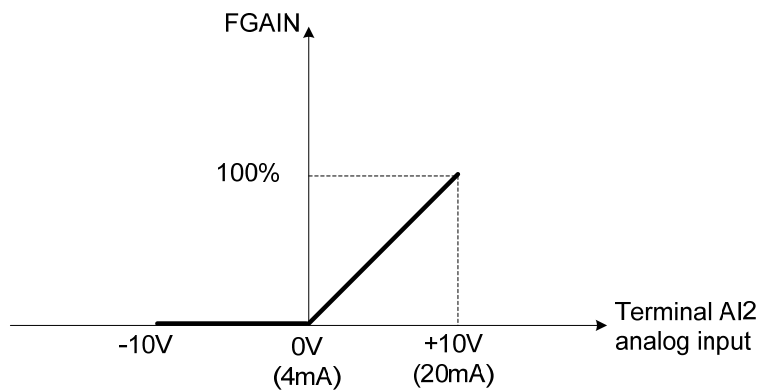

**Figure 4.4.38** Frequency gain adjustment

**Example:**

When the internal gain of AI1 (04-02) is set to 100% and AI2 to 5V (for example FGAIN = 50%), the reference frequency of terminal AI1 will be 50%, as shown in Figure 4.4.39.

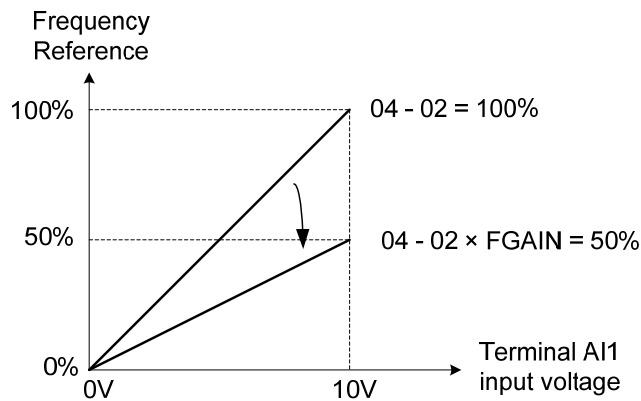

**Figure 4.4.39 Frequency reference gain adjustment (example)**

**04-05=2: Frequency reference bias (FBIAS)**

Multi-function analog input terminal AI2 can be used to adjust the frequency reference bias of AI1. The total frequency reference bias of terminal AI1 is the sum of internal bias set by parameter 04-03 and FBIAS. The maximum frequency reference for AI1 is 100%.

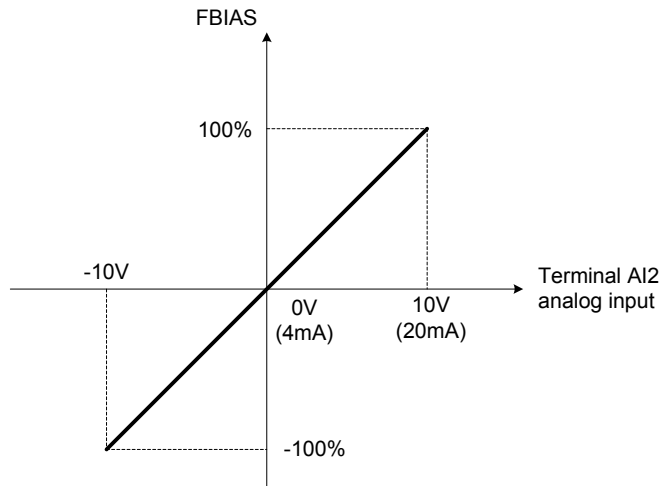

**Figure 4.4.40 Bias adjustment**

**Example:**

Terminal AI1 input is 0V, 04-02 = 100% (AI1 gain), 04-03 = 0% (AI1 bias) and terminal AI2 input is 3V. The reference frequency will be 30% as shown in Figure 4.4.41.

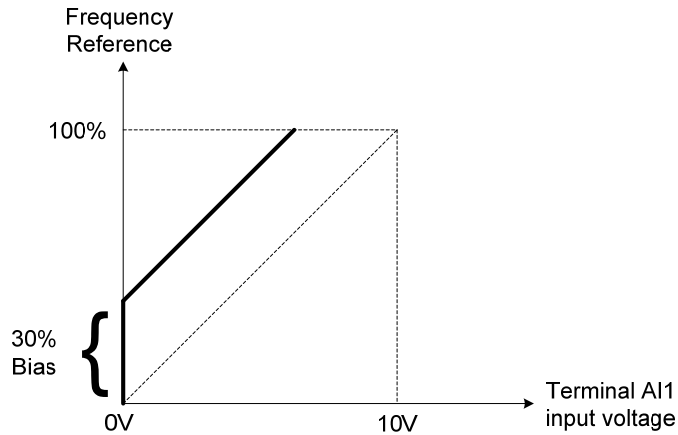
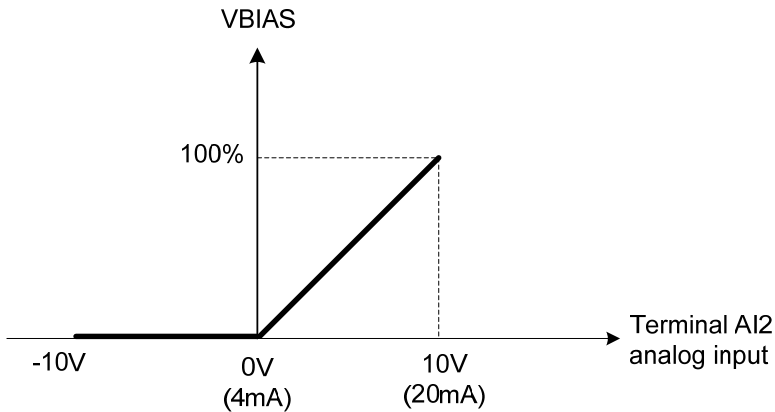

**Figure 4.4.41 Frequency Reference bias adjustment (example)**

**04-05=3: Output voltage bias (VBIAS)**

Multi-function analog input AI2 can be used to adjust the output voltage. The total output voltage of inverter is the sum of output voltage based on the selected V/F curve and VBIAS.

The maximum output voltage is set by 01-03, Vmax = 100%.



**Figure 4.4.42 Bias adjustment**

**04-05=4: Acceleration and deceleration coefficient (K)**

Multi-function analog input AI2 can be used to adjust the acceleration and deceleration time coefficient. The actual acceleration and deceleration time is calculated as follows:

$$\text{Actual accel /decel time} = \frac{\text{Acceleration / Deceleration time (00-14 ~ 00-17, 00-21, 00-24)}}{K}$$

Acceleration/ Deceleration time setting is 100% (00-14~00-17, 00-21~00-24).

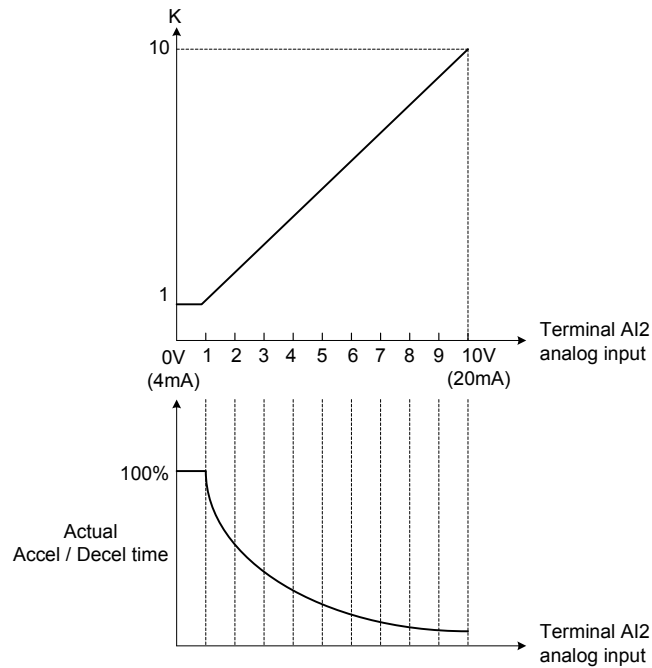

**Figure 4.4.43 Acceleration / deceleration time reduction coefficient**

**04-05=5: DC braking current**

Multi-function analog input AI2 can be used to adjust the DC Injection braking current. DC braking current parameter 07-07 setting should be set to 0% to use this function. The inverter rated current = 100%

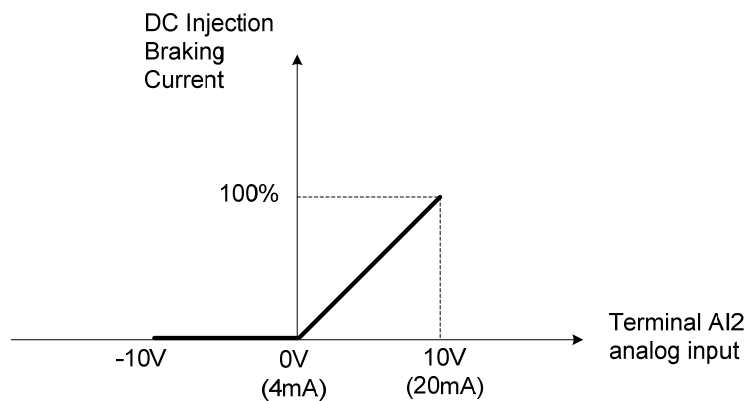

**Figure 4.4.44 DC braking current adjustment**

**04-05=6: Over-torque detection level**

Multi-function analog input AI2 can be used to adjust the over-torque detection level.

100% of inverter rated current (V/F or V/F + PG control mode)

100% motor rated torque (SLV or SV control mode)

If the multi-function analog input is used to adjust the over-torque level, the internal over-torque detection level (08-15) is disabled.

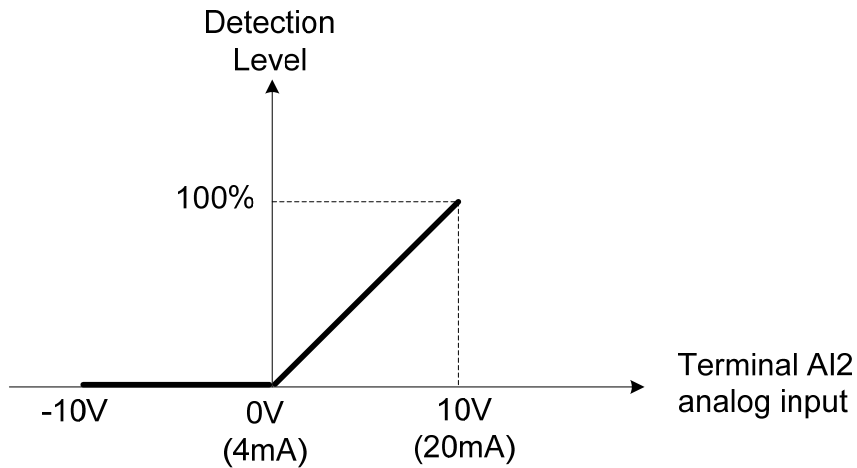

**Figure 4.4.45 Over-torque detection level adjustment**

**4-05=7: Stall prevention level during running**

Multi-function analog input AI2 can be used to adjust the stall prevention level during operation.

Inverter rated current = 100%. When AI2 is set to control stall prevention level (04-05 = 7) and parameter 08-03 (Stall prevention level during operation) is used, then the lesser of the two value becomes the active stall prevention level during operation.

**Example:** If the motor power is less than that of the inverter, the operation and the stall prevention of the motor will be based on the factory settings, multi-function analog input AI2 can be used to reduce the stall prevention level during operation.

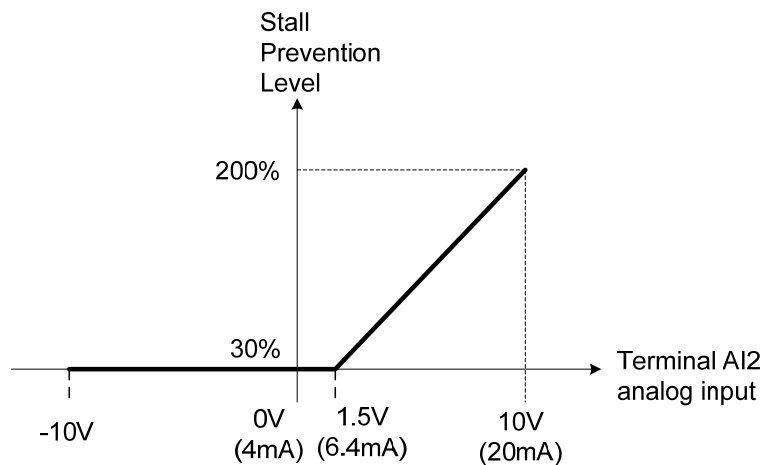

**Figure 4.4.46 Stall prevention level adjustment in operation**

**04-05=8: Frequency lower limit**

Multi-function analog input AI2 can be used to adjust the lower limit of frequency reference.

Maximum output frequency (Fmax, 01-02) = 100%. The actual lower limit is determined by the maximum value of 00-13 (frequency lower limit) and level of the multi-function analog input AI2.

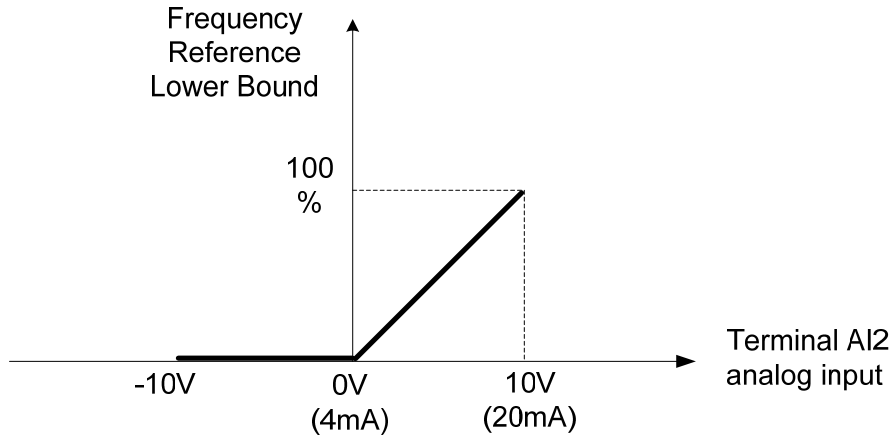
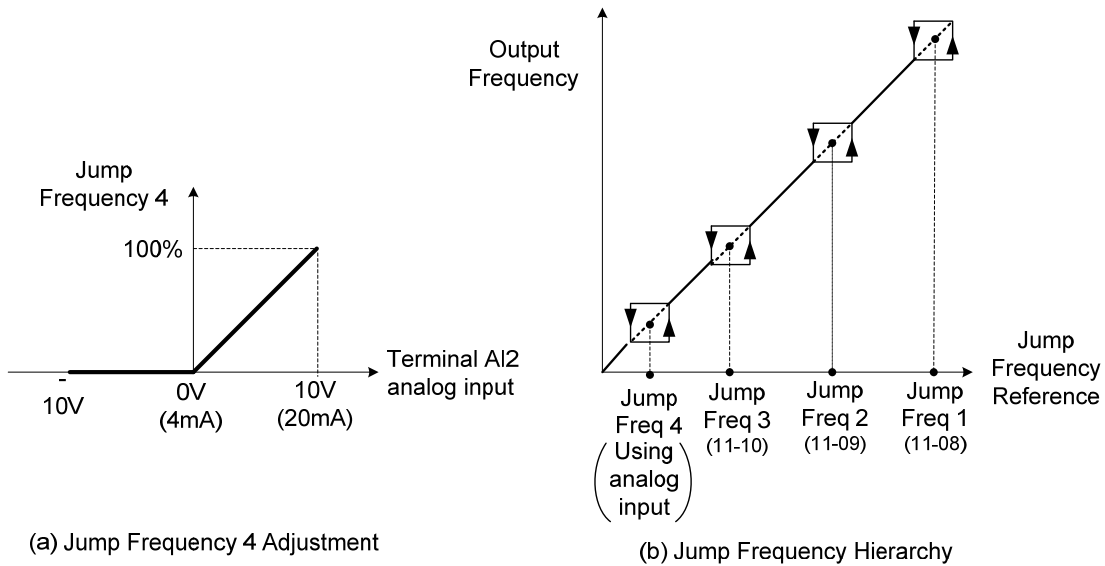

Figure 4.4.47 Adjustment of lower limit of frequency reference

**04-05=9:** Jump frequency 4

Multi-function analog input AI2 can be used to adjust Jump frequency 4.

Maximum output frequency (01-02, Fmax) = 100%. Setting 11-08 to 11-10 to 0.0Hz turns off the Jump frequency function.



(a) Jump Frequency 4 Adjustment

(b) Jump Frequency Hierarchy

Figure 4.4.48 Jump frequency 4 Setting Operation

**04-05=10:** Added to AI1

Multi-function analog input AI2 can be used as a bias level for analog input AI1.

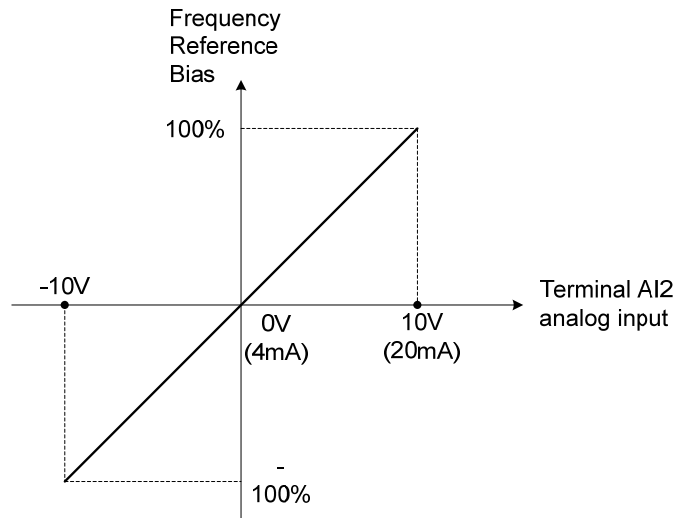

**Figure 4.4.49 Operation of being added to AI1 as bias**

**Example:**

04-02 (AI1 gain) = 100%, 04-03 (AI2 gain) = 0%, and terminal AI2 level is 2V. If input terminal AI1 is 0V, the internal reference frequency of terminal AI1 will be 20 %.

**04-05=11: Positive torque limit**

Multi-function analog input AI2 can be used to adjust the positive torque limit.

**04-05=12: Negative torque limit**

Multi-function analog input AI2 can be used to adjust the negative torque limit.

**04-05=13: Regenerative torque limit**

Multi-function analog input AI2 can be used to adjust the regenerative torque limit.

**04-05=14: Positive / negative torque limits**

Multi-function analog input AI2 can be used to adjust both the positive and negative torque limit.

For more details on torque limits, please refer to parameter group 21 - torque and position control group.

**04-05=15: Torque reference / torque limit of speed control**

Multi-function analog input AI2 can be used to adjust the torque reference / torque limit in closed loop vector mode.

**04-05=16: Torque reference/ Torque compensation of speed control**

Multi-function analog input AI2 can be used to adjust the torque reference / torque compensation in closed loop vector mode.

For more details on the torque control functions, please refer to parameter group 21 - torque and position control group.

**04-05=17: PTC Overheat Protection**

Use the sensor in the motor to stop from overheats. Please refer to 08-42~08-44 description for more details.



<b>04-11</b>	<b>AO1 function Setting</b>
<b>Range</b>	<ul style="list-style-type: none"> <li><b>0:</b> Output frequency</li> <li><b>1:</b> Frequency command</li> <li><b>2:</b> Output voltage</li> <li><b>3:</b> DC voltage</li> <li><b>4:</b> Output current</li> <li><b>5:</b> Output power</li> <li><b>6:</b> Motor speed</li> <li><b>7:</b> Output power factor</li> <li><b>8:</b> AI1 input</li> <li><b>9:</b> AI2 input</li> <li><b>10:</b> Torque command</li> <li><b>11:</b> q -axis current</li> <li><b>12:</b> d-axis current</li> <li><b>13:</b> Speed deviation</li> <li><b>14:</b> Reserved</li> <li><b>15:</b> ASR output</li> <li><b>16:</b> Reserved</li> <li><b>17:</b> q-axis voltage</li> <li><b>18:</b> d-axis voltage</li> <li><b>19~20:</b> Reserved</li> <li><b>21:</b> PID input</li> <li><b>22:</b> PID output</li> <li><b>23:</b> PID target value</li> <li><b>24:</b> PID feedback value</li> <li><b>25:</b> Output frequency of the soft starter</li> <li><b>26:</b> PG feedback</li> <li><b>27:</b> Reserved</li> <li><b>28:</b> Communication control</li> </ul>

<b>04-12</b>	<b>AO1 gain</b>
<b>Range</b>	0.0~1000.0%

<b>04-13</b>	<b>AO1 bias</b>
<b>Range</b>	-100.0~100.0%

<b>04-16</b>	<b>AO2 function setting</b>
<b>Range</b>	See parameter 04-11

<b>04-17</b>	<b>AO2 gain</b>
<b>Range</b>	0.0~1000.0%

<b>04-18</b>	<b>AO2 bias</b>
<b>Range</b>	-100.0~100.0%

For the analog output and related parameters, refer to figure 4.4.50.

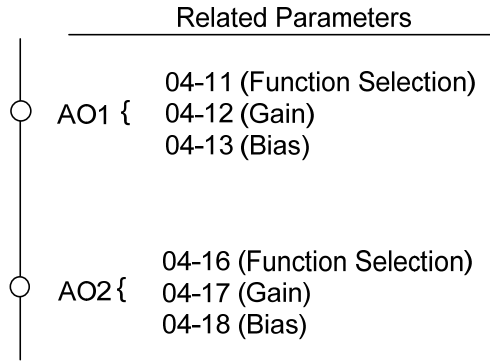

**Figure 4.4.50 Analog outputs and related parameters**

**Analog output AO1 and AO2 adjustment (04-12, 04-13 and 04-17, 04-18)**

**Signal:** Use parameter 04-11 to select the analog output signal for AO1 and parameter 04-16 to select the analog output signal for AO2.

**Gain:** Use parameter 04-12 to adjust the gain for AO1 and parameter 04-17 to adjust the gain for AO2. Adjust the gain so that the analog output (10V/20mA) matches 100% of the selected analog output signal (04-11 for AO1 and 04-16 for AO2).

**Bias:** Use parameter 04-13 to adjust the bias for AO1 and parameter 04-18 to adjust the bias for AO2. Adjust the bias so that the analog output (0V/4mA) matches 0% of the selected analog output signal (04-11 for AO1 and 04-16 for AO2).

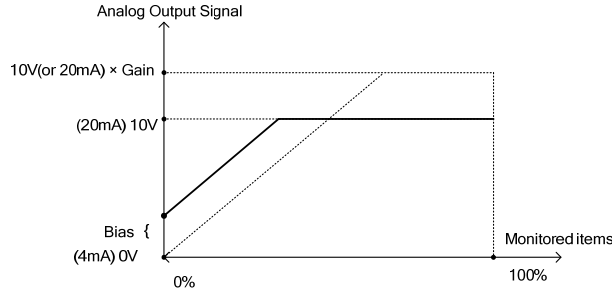

**Figure 4.4.51 Analog output level adjustment**

**Analog output terminal function selection (04-11 and 04-16)**

Refer to the following table 4.4.33.

**Table 4.4.33 Selection of analog output terminals function (04-11 and 04-16)**

04-11, 04-16 Parameter setting	Function (Keypad display)	Monitoring Parameters Group 12	Control Mode						
			VF	VF+PG	SLV	SV	PM SV	PM SLV	SLV2
0	Output Freq	12-17	O	O	O	O	O	O	O
1	Freq Ref	12-16	O	O	O	O	O	O	O
2	Output Voltage	12-19	O	O	O	O	O	O	O
3	DC Voltage	12-20	O	O	O	O	O	O	O
4	Output Current	12-18	O	O	O	O	O	O	O
5	Output KW	12-21	O	O	O	O	O	O	O
6	Motor Speed	12-22	O	O	O	O	O	O	O
7	Output PF	12-23	O	O	O	O	O	O	O
8	AI1 Input	12-25	O	O	O	O	O	O	O
9	AI2 Input	12-26	O	O	O	O	O	O	O
10	Torque Ref	12-27	X	X	O	O	O	O	X
11	Current Iq	12-28	X	X	O	O	O	O	X
12	Current Id	12-29	X	X	O	O	O	O	X
13	Speed Deviation	12-30	X	X	X	O	O	X	X
14	Reserved		X	X	X	X	X	X	X
15	ASR Output	12-32	X	O	X	O	O	X	X
16	Reserved	-	X	X	X	X	X	X	X
17	Voltage Ref Vq	-	X	X	O	O	O	O	X
18	Voltage Ref Vd	-	X	X	O	O	O	O	X
19	Reserved	-	X	X	X	X	X	X	X
20	Reserved	-	X	X	X	X	X	X	X
21	PID Input	12-36	O	O	O	O	O	O	O
22	PID Output	12-37	O	O	O	O	O	O	O
23	PID Setpoint	12-38	O	O	O	O	O	O	O
24	PID Feedback	12-39	O	O	O	O	O	O	O
25	Output Freq (SFS)	-	O	O	O	O	O	O	O
26	PG Feedback	12-33	X	O	X	O	O	X	X
27	Reserved	-	X	X	X	X	X	X	X
28	Comm Control	-	O	O	O	O	O	O	O

04-19	AO output signal type
Range	<b>【0】 : AO1 0~10V; AO2 0~10V</b> <b>【1】 : AO1 0~10V; AO2 4~20mA</b> <b>【2】 : AO1 4~20mA; AO2 0~10V (For enhanced E &amp; G type)</b> <b>【3】 : AO1 4~20mA; AO2 4~20mA (For enhanced E &amp; G type)</b>

- For standard H & C type:  
It is required to be with the setting of SW6 on the control board when AO2 analog output signal is active.  
When 04-19=0 (AO2 is 0~10V) and SW6 on the control board is V, AO2 output signal type is voltage.  
When 04-19=1 (AO2 is 4~20mA and SW6 on the control board is I, AO2 output signal type is current.
- For enhanced E & G type:  
It is required to be with the setting of SW1 and SW2 on the control board when AO1 and AO2 analog output signals are active.  
When 04-19=0, AO1 is 0~10V, and SW1 on the control board is V, AO1 output signal type is voltage.  
AO2 is 0~10V, and SW2 on the control board is V, AO2 output signal type is voltage.

When 04-19=1, AO1 is 0~10V, and SW1 on the control board is V, AO1 output signal type is voltage.  
 AO2 is 4~20mA, and SW2 on the control board is I, AO2 output signal type is current.  
 When 04-19=2, AO1 is 4~20mA, and SW1 on the control board is I, AO1 output signal type is current.  
 AO2 is 0~10V, and SW2 on the control board is V, AO2 output signal type is voltage.  
 When 04-19=3, AO1 is 4~20mA, and SW1 on the control board is I, AO1 output signal type is current.  
 AO2 is 4~20mA, and SW2 on the control board is I, AO2 output signal type is current.

<b>04-20</b>	<b>Filter time of AO signal scan</b>
<b>Range</b>	<b>【0.00~0.50】 Sec</b>

Setting of parameter 04-20 is used for filtering momentary change in analog output signal. When it is enabled, system response will lower down and interference protection will enhance.

<b>05- Multi-Speed Parameters</b>
-----------------------------------

<b>05-00</b>	<b>Acceleration and deceleration selection of multi-speed</b>
<b>Range</b>	<b>0: Acceleration and deceleration time 1 ~ 4 used. 1: Use independent acceleration and deceleration time for each multi-speed setting.</b>

**05-00=0:** Standard Acceleration and deceleration times parameters 00-14 ~ 00-17 / 00-21 ~ 00-24 are used for multi-speed 0 ~ 15.

**05-00=1:** Each multi-speed uses a dedicated acceleration and deceleration time parameters 05-17 ~ 05-48. There are two different modes for acceleration / deceleration timing when 05-00 is set to 1, see time example on the next page.

**Acceleration time calculation formula**

$$\text{Time it takes to reach set frequency} = \frac{\text{Acceleration time} \times (\text{set frequency} - \text{output frequency})}{\text{Maximum output frequency}}$$

**Deceleration time calculation formula**

$$\text{Time it takes to reach set frequency} = \frac{\text{Deceleration time} \times (\text{output frequency} - \text{set frequency})}{\text{Maximum output frequency}}$$

**Maximum output frequency:** Parameter 01-00=F, maximum output frequency set by 01-02, 01-00 ≠ F, maximum output frequency determined by V/F curve selected (50.0 / 60.0 / 90.0 / 120.0 / 180.0).

**Example:** 01-00=01 (50Hz (maximum output frequency)), 05-02=10 Hz (multi-step speed 0), 05-17=5.0s (Acceleration time), 05-18=20.0 sec. (Deceleration time).

**Acceleration time calculation formula**

$$\text{Time it takes to reach set frequency} = \frac{5.0 \times 10 \text{ Hz}}{50 \text{ Hz}} = 1.0 \text{ sec.}$$

**Deceleration time calculation formula**

$$\text{Time it takes to reach set frequency} = \frac{20.0 \times 10 \text{ Hz}}{50 \text{ Hz}} = 4.0 \text{ sec.}$$

**Example:** Acceleration / deceleration timing when 05-00 is set to 1. In this example the following parameters are set:

- 00-02=1 (External terminal operation)
- 03-00=0 (Terminal S1: Forward /Stop)
- 03-01=1 (Terminal S2: Reversal /Stop)
- 03-02=2 (Terminal S3: Speed 1)
- 03-03=3 (Terminal S4: Speed 2)
- 03-03=4 (Terminal S5: Speed 3)

\*Speed 1 is required to confirm if AI2 function setting (04-05) is set to 0 (Auxiliary frequency). If 04-05=0, it will make the frequency of speed 1 set to AI2 auxiliary frequency and the value is determined by AI2. If function of speed 1 is generally used, set AI2 to other functions except 0 (the recommended value: set 10 ADD to AI1.)

**Acceleration / Deceleration Calculation Mode 1:**

If the run command is cycled on and off, acceleration and deceleration time (a ~ f) is calculated based on the active speed command as follows:

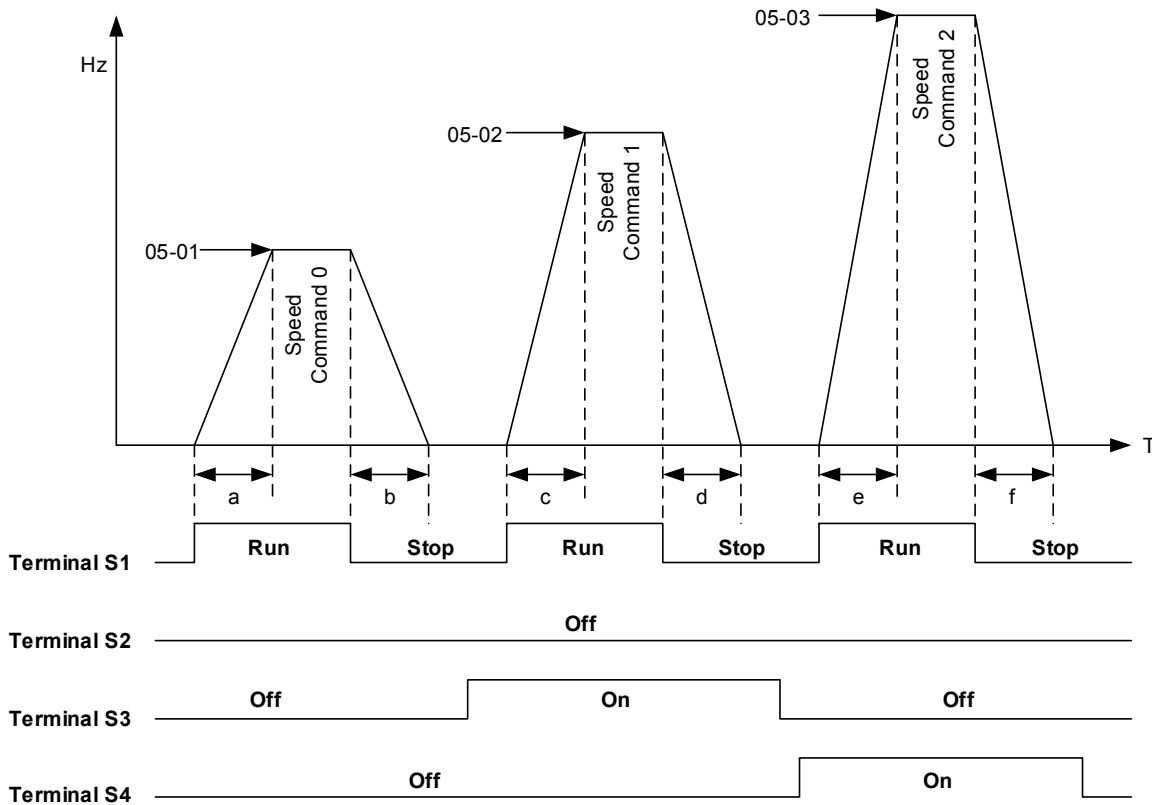

$$\begin{aligned}
 a &= \frac{(05-17) \times (05-01)}{(01-02)} & b &= \frac{(05-18) \times (05-01)}{(01-02)} & c &= \frac{(05-19) \times (05-02)}{(01-02)} & \text{in sec.} \\
 d &= \frac{(05-20) \times (05-02)}{(01-02)} & e &= \frac{(05-21) \times (05-03)}{(01-02)} & f &= \frac{(05-22) \times (05-03)}{(01-02)} & \text{in sec.}
 \end{aligned}$$

### Acceleration / Deceleration Calculation Mode 2:

If the run command is remains on, acceleration and deceleration time (a ~ f) is calculated based on the active speed command as follows:

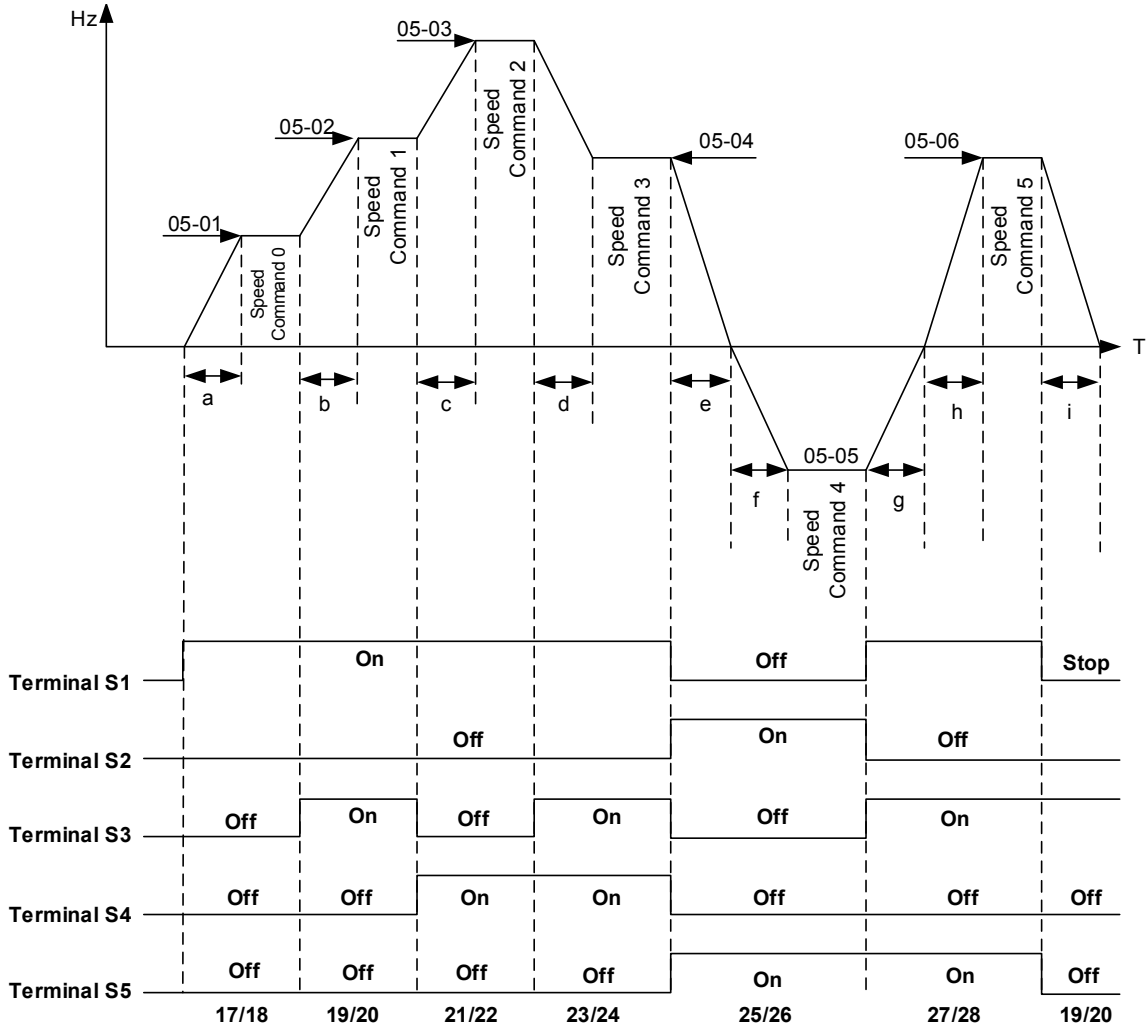

$$a = \frac{(05-17) \times (05-01)}{(01-02)} \quad b = \frac{(05-19) \times [(05-02) - (05-01)]}{(01-02)} \quad c = \frac{(05-21) \times [(05-03) - (05-02)]}{(01-02)} \quad \text{in sec.}$$

$$d = \frac{(05-24) \times [(05-03) - (05-04)]}{(01-02)} \quad e = \frac{(05-26) \times (05-04)}{(01-02)} \quad f = \frac{(05-25) \times (05-05)}{(01-02)} \quad \text{in sec.}$$

$$g = \frac{(05-27) \times (05-05)}{(01-02)} \quad h = \frac{(05-27) \times (05-06)}{(01-02)} \quad i = \frac{(05-19) \times (05-06)}{(01-02)} \quad \text{in sec.}$$

<b>05-01</b>	<b>Frequency setting of speed-stage 0</b>
<b>Range</b>	0.0~599.00 Hz
<b>05-17</b>	<b>Acceleration time setting for multi speed 0</b>
<b>Range</b>	0.0~6000.0 Sec
<b>05-18</b>	<b>Deceleration time setting for multi speed 0</b>
<b>Range</b>	0.0~6000.0 Sec
<b>05-19</b>	<b>Acceleration time setting for multi speed 1</b>
<b>Range</b>	0.0~6000.0 Sec
<b>05-20</b>	<b>Deceleration time setting for multi speed 1</b>
<b>Range</b>	0.0~6000.0 Sec
<b>05-21</b>	<b>Acceleration time setting for multi speed 2</b>
<b>Range</b>	0.0~6000.0 Sec
<b>05-22</b>	<b>Deceleration time setting for multi speed 2</b>
<b>Range</b>	0.0~6000.0 Sec
<b>05-23</b>	<b>Acceleration time setting for multi speed 3</b>
<b>Range</b>	0.0~6000.0 Sec
<b>05-24</b>	<b>Deceleration time setting for multi speed 3</b>
<b>Range</b>	0.0~6000.0 Sec
<b>05-25</b>	<b>Acceleration time setting for multi speed 4</b>
<b>Range</b>	0.0~6000.0 Sec
<b>05-26</b>	<b>Deceleration time setting for multi speed 4</b>
<b>Range</b>	0.0~6000.0 Sec
<b>05-27</b>	<b>Acceleration time setting for multi speed 5</b>
<b>Range</b>	0.0~6000.0 Sec
<b>05-28</b>	<b>Deceleration time setting for multi speed 5</b>
<b>Range</b>	0.0~6000.0 Sec
<b>05-29</b>	<b>Acceleration time setting for multi speed 6</b>
<b>Range</b>	0.0~6000.0 Sec
<b>05-30</b>	<b>Deceleration time setting for multi speed 6</b>
<b>Range</b>	0.0~6000.0 Sec
<b>05-31</b>	<b>Acceleration time setting for multi speed 7</b>
<b>Range</b>	0.0~6000.0 Sec

<b>05-32</b>	<b>Deceleration time setting for multi speed 7</b>
<b>Range</b>	0.0~6000.0 Sec
<b>05-33</b>	<b>Acceleration time setting for multi speed 8</b>
<b>Range</b>	0.0~6000.0 Sec
<b>05-34</b>	<b>Deceleration time setting for multi speed 8</b>
<b>Range</b>	0.0~6000.0 Sec
<b>05-35</b>	<b>Acceleration time setting for multi speed 9</b>
<b>Range</b>	0.0~6000.0 Sec
<b>05-36</b>	<b>Deceleration time setting for multi speed 9</b>
<b>Range</b>	0.0~6000.0 Sec
<b>05-37</b>	<b>Acceleration time setting for multi speed 10</b>
<b>Range</b>	0.0~6000.0 Sec
<b>05-38</b>	<b>Deceleration time setting for multi speed 10</b>
<b>Range</b>	0.0~6000.0 Sec
<b>05-39</b>	<b>Acceleration time setting for multi speed 11</b>
<b>Range</b>	0.0~6000.0 Sec
<b>05-40</b>	<b>Deceleration time setting for multi speed 11</b>
<b>Range</b>	0.0~6000.0 Sec
<b>05-41</b>	<b>Acceleration time setting for multi speed 12</b>
<b>Range</b>	0.0~6000.0 Sec
<b>05-42</b>	<b>Deceleration time setting for multi speed 12</b>
<b>Range</b>	0.0~6000.0 Sec
<b>05-43</b>	<b>Acceleration time setting for multi speed 13</b>
<b>Range</b>	0.0~6000.0 Sec
<b>05-44</b>	<b>Deceleration time setting for multi speed 13</b>
<b>Range</b>	0.0~6000.0 Sec
<b>05-45</b>	<b>Acceleration time setting for multi speed 14</b>
<b>Range</b>	0.0~6000.0 Sec
<b>05-46</b>	<b>Deceleration time setting for multi speed 14</b>
<b>Range</b>	0.0~6000.0 Sec
<b>05-47</b>	<b>Acceleration time setting for multi speed 15</b>
<b>Range</b>	0.0~6000.0 Sec
<b>05-48</b>	<b>Deceleration time setting for multi speed 15</b>
<b>Range</b>	0.0~6000.0 Sec



## 06-Automatic Program Operation Parameters

06-00	Automatic operation mode selection
<b>Range</b>	<p><b>0:</b> Disable</p> <p><b>1:</b> Execute a single cycle operation. Restart speed is based on the previous stopped speed.</p> <p><b>2:</b> Execute continuous cycle operation. Restart speed is based on the previous cycle stop speed.</p> <p><b>3:</b> After completion of a single cycle, the on-going operation speed is based on the speed of the last stage. Restart speed is based on the previous stopped speed</p> <p><b>4:</b> Execute a single cycle operation. Restart speed is based on the Speed-Stage 0.</p> <p><b>5:</b> Execute continuous cycle operation. Restart speed is based on the Speed-Stage 0.</p> <p><b>6:</b> After completion of a single cycle, the on-going operation speed is based on the speed of the last stage. Restart speed is based on the Speed-Stage 0</p>

Automatic operation mode uses frequency reference parameters 05-01, 06-01~06-15, operation time parameters 06-16 ~ 06-31 and direction of operation parameters 06-32~06-47.

### Notes:

The automatic operation mode is disabled when any of the following functions are active:

- Frequency wobbling function
- PID function

When automatic operation mode is active, external multi-step speed reference command 1~4 (03-00~03-07=2~5) is disabled.

### Example 1: Automatic operation mode – Single cycle

In this example the inverter executes a single cycle and then stops.

### Parameter Settings:

06-00 =	1 or 4 (Single cycle operation)
06-32~06-34=	1 (Forward for multi-step speed 0 - 2)
06-47=	2 (Reverse for multi-step speed 15)
06-35~06-46=	0 (Stop for multi-step speed 3 - 14)
05-01=	15 Hz (Multi-step speed 0: 15 Hz)
06-01=	30 Hz (Multi-step speed 1: 30 Hz)
06-02=	50 Hz (Multi-step speed 2: 50 Hz)
06-15=	20Hz (Multi-step speed 15: 20 Hz)
06-16=	20 sec (Multi-step time 0: 20 sec)
06-17=	25 sec (Multi-step time 1: 25 sec)
06-18=	30 sec (Multi-step time 2: 30 sec)
06-31=	40 sec (Multi-step time 15: 40 sec)

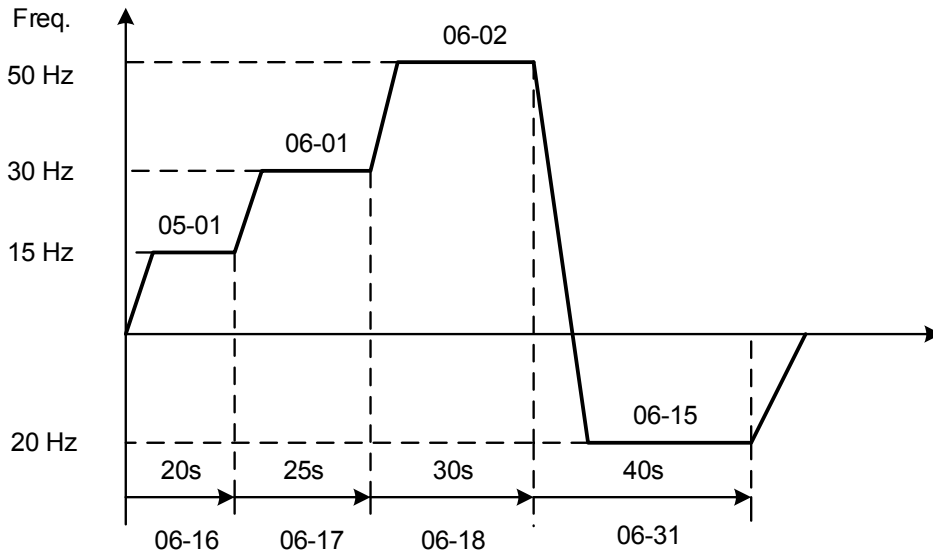

**Figure 4.4.52 Single cycle automatic operation (stop)**

**Example 2:** Automatic operation mode – Continuous cycle

In this example the inverter repeats the same cycle.

**Parameter Settings:**

- 06-00 = 2 or 5 (Continuous cycle operation)
- 06-01~06-47= Enter the same setting as that of Example 1.

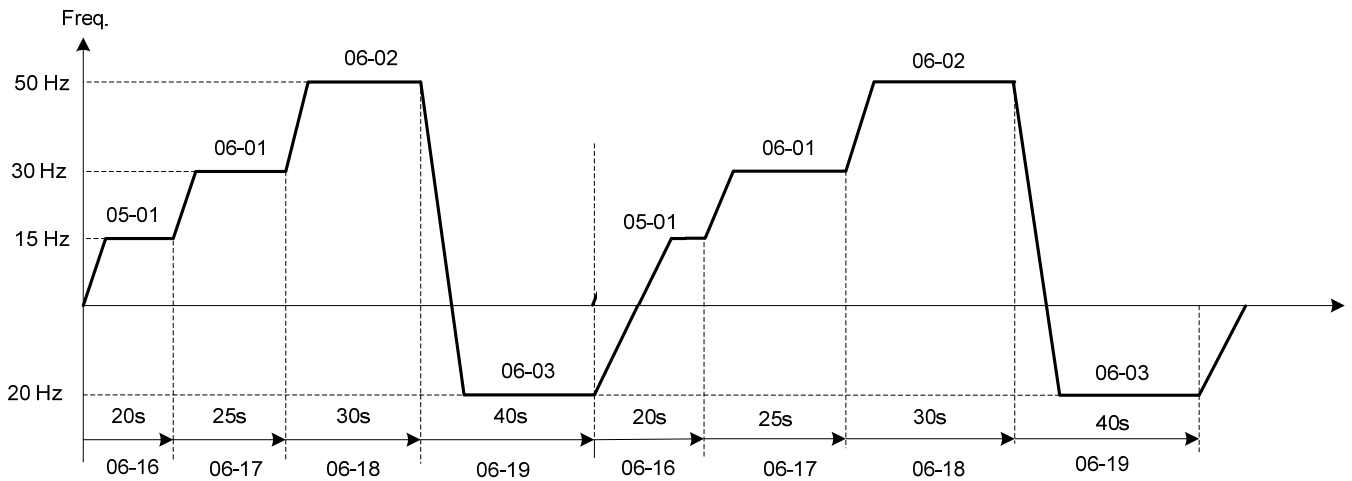

**Figure 4.4.53 Periodic automatic operation**

**Example 3:** Automatic operation mode – Single cycle and continue running at last speed of the cycle

In this example the inverter executes a single cycle and continue running at last speed of the cycle.

**Parameter Settings:**

- 06-00= 3 or 6 (Single cycle operation)
- 06-32~06-35= 1 (Forward)
- 06-36~06-47= 0
- Other parameter = Enter same setting as that of Example 1.

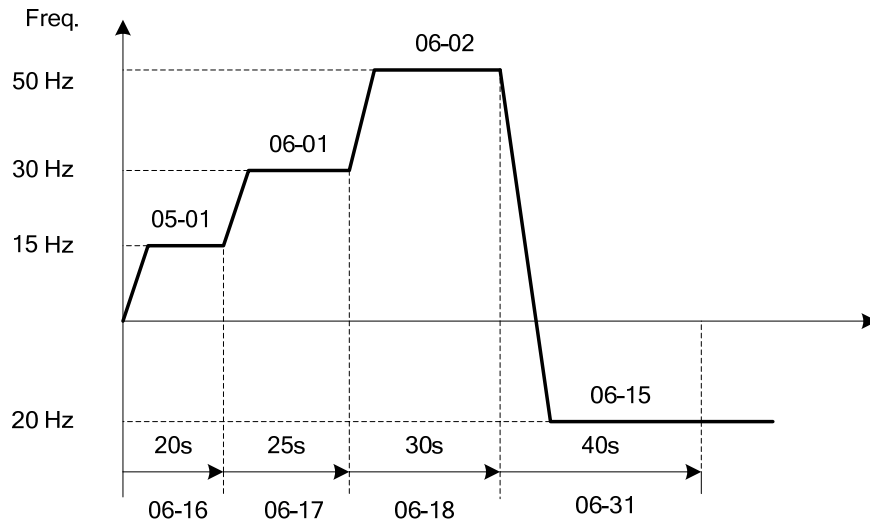

**Figure 4.4.54 Single cycle automatic operation (continuous)**

06-00= 1 to 3:

After a stop the inverter will restart with the incomplete step when the run command is re-applied.

06-00= 4 to 6:

After a stop the inverter will restart with the first step of the cycle when the run command is re-applied.

06-00	1 to 3	06-00	4 to 6
Output Frequency	<p>Operation Command: RUN STOP RUN</p> <p>Output Frequency: (Graph showing a cycle that is restarted from the point where it stopped)</p> <p>Continue with incompleted step cycle</p>	<p>Operation Command: RUN STOP RUN</p> <p>Output Frequency: (Graph showing a cycle that is restarted from the beginning)</p> <p>Start new cycle</p>	

**Notes:**

- Acceleration/ deceleration time is set with the setting of 00-14 and 00-15 in the automatic operation mode.
- If the setting value of parameters 06-16~06-31 is 0, automatic operation mode is not active.

<b>Automatic operation frequency reference settings</b>	
<b>06-01</b>	<b>Frequency setting of speed-stage 1</b>
<b>06-02</b>	<b>Frequency setting of speed-stage 2</b>
<b>06-03</b>	<b>Frequency setting of speed-stage 3</b>
<b>06-04</b>	<b>Frequency setting of speed-stage 4</b>
<b>06-05</b>	<b>Frequency setting of speed-stage 5</b>
<b>06-06</b>	<b>Frequency setting of speed-stage 6</b>
<b>06-07</b>	<b>Frequency setting of speed-stage 7</b>
<b>06-08</b>	<b>Frequency setting of speed-stage 8</b>
<b>06-09</b>	<b>Frequency setting of speed-stage 9</b>
<b>06-10</b>	<b>Frequency setting of speed-stage 10</b>
<b>06-11</b>	<b>Frequency setting of speed-stage 11</b>
<b>06-12</b>	<b>Frequency setting of speed-stage 12</b>
<b>06-13</b>	<b>Frequency setting of speed-stage 13</b>
<b>06-14</b>	<b>Frequency setting of speed-stage 14</b>
<b>06-15</b>	<b>Frequency setting of speed-stage 15</b>
<b>Range</b>	0.00~599.00 Hz

<b>Automatic operation time settings</b>	
<b>06-16</b>	<b>Operation time setting of speed-stage 0</b>
<b>06-17</b>	<b>Operation time setting of speed-stage 1</b>
<b>06-18</b>	<b>Operation time setting of speed-stage 2</b>
<b>06-19</b>	<b>Operation time setting of speed-stage 3</b>
<b>06-20</b>	<b>Operation time setting of speed-stage 4</b>
<b>06-21</b>	<b>Operation time setting of speed-stage 5</b>
<b>06-22</b>	<b>Operation time setting of speed-stage 6</b>
<b>06-23</b>	<b>Operation time setting of speed-stage 7</b>
<b>06-24</b>	<b>Operation time setting of speed-stage 8</b>
<b>06-25</b>	<b>Operation time setting of speed-stage 9</b>
<b>06-26</b>	<b>Operation time setting of speed-stage 10</b>
<b>06-27</b>	<b>Operation time setting of speed-stage 11</b>
<b>06-28</b>	<b>Operation time setting of speed-stage 12</b>
<b>06-29</b>	<b>Operation time setting of speed-stage 13</b>
<b>06-30</b>	<b>Operation time setting of speed-stage 14</b>
<b>06-31</b>	<b>Operation time setting of speed-stage 15</b>
<b>Range</b>	0.0~6000.0 Sec

<b>Automatic operation direction settings</b>	
<b>06-32</b>	<b>Operation direction selection of speed-stage 0</b>
<b>06-33</b>	<b>Operation direction selection of speed-stage 1</b>
<b>06-34</b>	<b>Operation direction selection of speed-stage 2</b>
<b>06-35</b>	<b>Operation direction selection of speed-stage 3</b>
<b>06-36</b>	<b>Operation direction selection of speed-stage 4</b>
<b>06-37</b>	<b>Operation direction selection of speed-stage 5</b>
<b>06-38</b>	<b>Operation direction selection of speed-stage 6</b>
<b>06-39</b>	<b>Operation direction selection of speed-stage 7</b>
<b>06-40</b>	<b>Operation direction selection of speed-stage 8</b>
<b>06-41</b>	<b>Operation direction selection of speed-stage 9</b>
<b>06-42</b>	<b>Operation direction selection of speed-stage 10</b>
<b>06-43</b>	<b>Operation direction selection of speed-stage 11</b>
<b>06-44</b>	<b>Operation direction selection of speed-stage 12</b>
<b>06-45</b>	<b>Operation direction selection of speed-stage 13</b>
<b>06-46</b>	<b>Operation direction selection of speed-stage 14</b>
<b>06-47</b>	<b>Operation direction selection of speed-stage 15</b>
<b>Range</b>	<b>0: Stop, 1: Forward, 2: Reverse</b>

### 07- Start/Stop Parameters

<b>07-00</b>	<b>Momentary Power Loss/Fault Restart Selection</b>
<b>Range</b>	0: Disable 1: Enable

**07-00=0:** Inverter trips on “UV” fault if power loss time is greater than 8ms.

**07-00=1:** Inverter restarts after restarting the power at the momentary power loss.

**Note:** When 07-00=1, inverter restore automatically the motor rotation after restarting the power even if momentary power loss occurs.

<b>07-01</b>	<b>Fault reset time</b>
<b>Range</b>	0~7200 Sec

Restart time of momentary power loss is the same as Fault reset time.

07-01 < 07-18: Automatic restart time interval is set by minimum baseblock time (07-18).

07-01 > 07-18: Automatic restart time interval is set by fault reset time (07-01).

**Note:**

Automatic restart time interval is time of 07-18 plus 07-01 and delay time of peed search (07-22).

Refer to Figure 4.4.55 for automatic restart interval.

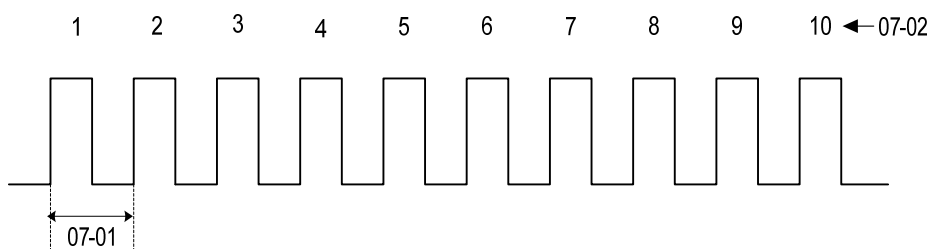

**Figure 4.4.55 Automatic restart interval**

<b>07-02</b>	<b>Number of restart attempts</b>
<b>Range</b>	0~10

If numbers of fault reset reaches the setting value of 07-02, then inverter stops running. So manual to restart the inverter after eliminating fault causes.

When the automatic restart function is enabled the internal automatic restart attempt counter is reset based on the following actions:

- a) No fault occurs in 10 minutes or longer after the automatic restart
- b) Reset command to clear fault via input terminal or using the keypad (ex: press reset/ ◀ key)
- c) Power to the inverter is turned off and back on again

**Note:**

Multi-function digital output R1A-R1C, R2A-R2C, or optocoupler output can be programmed to activate during an automatic reset attempt, refer to parameter 03-11, 03-12 and 03-28.

**Automatic restart operation:**

- a) Fault is detected. The inverter turn off the output, displays the fault on the keypad and waits for the minimum baseblock time parameter 07-18 to expire before accepting another run / automatic restart command.
- b) After the minimum baseblock time (07-18) and delay time of speed search have expired, the active fault is reset and a speed search operation is performed. The time between each fault restart attempt is set by parameter 07-01.
- c) When the total number of restart attempts exceed the number of automatic restart attempts set in parameter 07-02, the inverter will turn off the output and the fault contact is activated.

Please refer to Figure 4.4.56 for the automatic restart operation.

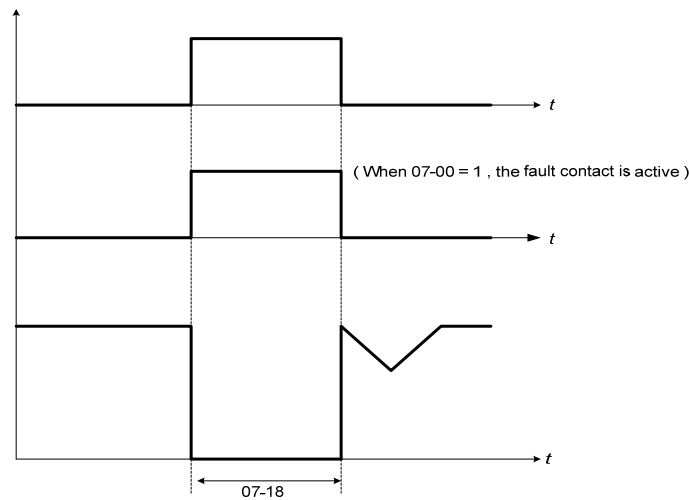

**Figure 4.4.56 Auto-restart operation.**

The automatic restart function is active for the following faults. Please note that when the fault is not listed in the table the inverter will not attempt an automatic restart.

Parameter Name	Faults	Numbers of Restart
<b>07-00</b>	<b>UV</b> (under voltage)	<b>Unlimited</b>
<b>07-01</b>	<b>OC</b> (over current) <b>OCA</b> (over current in ACC.) <b>OCC</b> (over current in constant speed) <b>OCd</b> (over current in DEC)	<b>Depend on parameter 07-02</b>
<b>07-02</b>	<b>OL1</b> (motor overload) <b>UT</b> (Under torque detection) <b>IPL</b> (input phase loss)	
	<b>GF</b> (ground failure) <b>OV</b> (overvoltage) <b>OL2</b> (Inverter overload) <b>OT</b> (Over-torque detection) <b>OPL</b> (Output phase loss) <b>CF07</b> (SLV motor control setting fault) <b>CF08</b> (PMSLV motor control setting fault)	

**Notes:**

- 1. Fault restart function contains momentary power loss restart and auto reset restart.
- 2. Refer to chapter 10 for the details of troubleshooting and fault diagnostics.
- 3. Refer to speed search function (07-19~07-24) for the selection of speed search modes.

**Note:**

Automatic restart function is only active in the state of no harm to the safety or to the application devices.

**Warning - Excessively use of the automatic restart function will damage the inverter.**

<b>07-04</b>	<b>Direct Start at Power on</b>
<b>Range</b>	<b>【0】</b> : When the external run command is enabled, direct start at power up <b>【1】</b> : When the external run command is enabled, unable to direct start at power-up.

**07-04=0,**

If operation switch is conducted at power up, the inverter will start automatically.

**07-04=1,**

If operation switch is not conducted at power up, the inverter is not able to start and the warning signal of STP1 flashes. It is required to turn off the operation switch first, and then make it be conducted to start the inverter.

<b>07-05</b>	<b>Delay of Direct Start at Power on</b>
<b>Range</b>	<b>【1.0~300.0】 Sec</b>

If 07-04=0, it will count the delay time set by 07-05 first when the inverter starts directly at power on. When the delay time is completed, it starts to run.

**! DANGER:**

- **When 07-04=【0】 and the external run is set (00-02/ 00-03=1),**  
If the operation switch is conducted at power up, the inverter starts automatically. It is suggested to turn off the power switch and operation switch at power failure to avoid the damage to the user or the machine when the inverter reconnects.
- **When 07-04=【1】 and the external run is set (00-02/ 00-03=1),**  
If the operation switch is not conducted at power up, the inverter is not able to start and the warning signal of STP1 flashes. It is required to turn off the operation switch first and the delay time of direct start at power up is completed. Then make it be conducted to start the inverter.

<b>07-06</b>	<b>DC injection braking starting frequency</b>
<b>Range</b>	0.0~10.0 Hz

The braking act according to the different control modes, please refer to the following descriptions:

1. Control mode: VF、VF+PG、SLV and SLV2 (00-00 = 0、1、2、6)

It starts DC injection braking by the time 07-16. Deceleration to stop is according to 07-06 and 07-08. When output frequency is lower than 07-06 in deceleration time, it starts DC injection braking by the time 07-08.

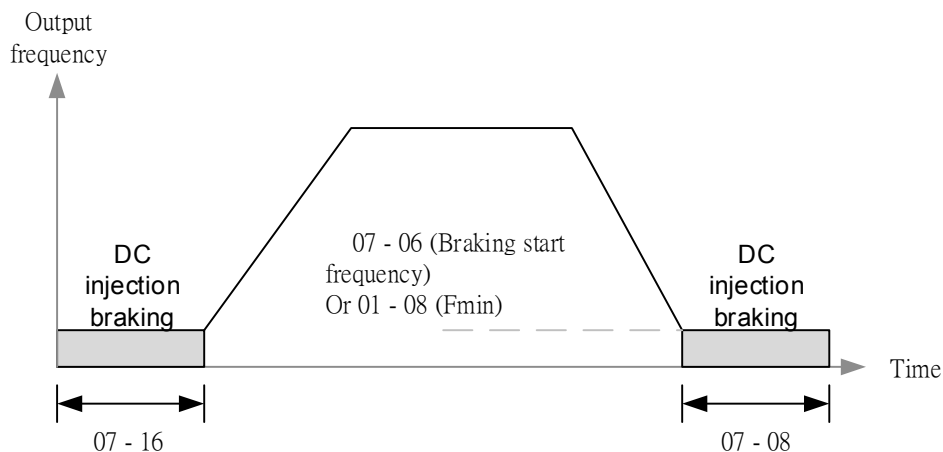

**Figure 4.4.57a VF、VF+PG、SLV and SLV2 DC injection braking**

**Note:** When 07-06 < 01-08, it starts DC injection braking by the setting frequency (01-08)



2. Control mode: PMSLV (00-00=5)

Set short-circuit braking time at start and DC braking time at start individually by parameter 07-34 and 07-16. Braking action at start is active to perform SC braking by the set time of 07-34 and then to perform DC braking by that of 07-16. When deceleration to stop, set short-circuit braking time at stop and DC braking time at stop individually by parameter 07-35 and 07-08. When the output frequency falls below 07-06 at deceleration, perform short-circuit braking by the set time of 07-35 and then perform DC braking by the set time of 07-08. Refer to Fig. 4.4.57b for the braking action.

Note:

1. If 07-06 < 01-08, braking action is active by the set frequency of 01-08.
2. DC braking current level at start or stop is set by 07-07 on the base of inverter rated current being 100%.
3. If DC braking current level set by 07-07 is higher than the motor rated current, DC braking current level is limited to the motor rated value.
4. SC braking current level at start or stop is set by 07-36 on the base of motor rated current being 100%.

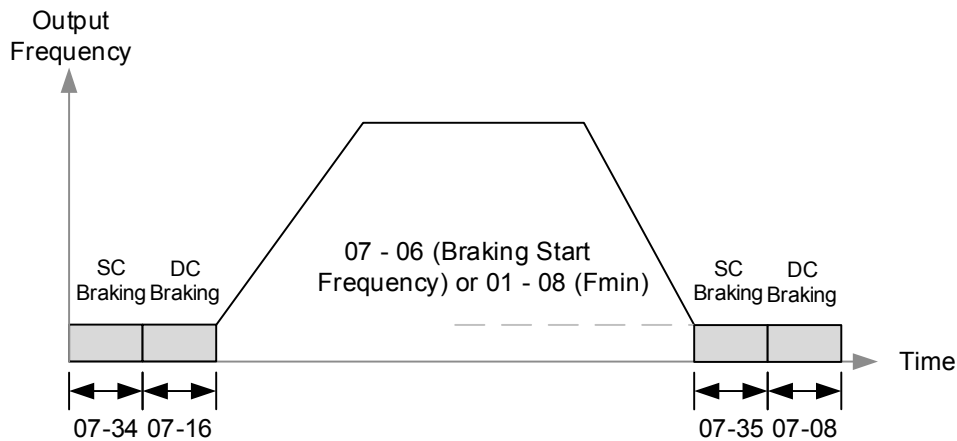

Figure 4.4.57b PMSLV short-circuit braking

**Note:** When 07-06 < 01-08, it starts short-circuit braking by the setting frequency (01-08)

3. Control mode: SV and PMSV(00-00=3、4)

It starts zero-speed operation by the time 07-16. Deceleration to stop is according to 07-06 and 07-08. When output frequency is lower than 07-06 in deceleration time, it starts zero-speed operation by the time 07-08.

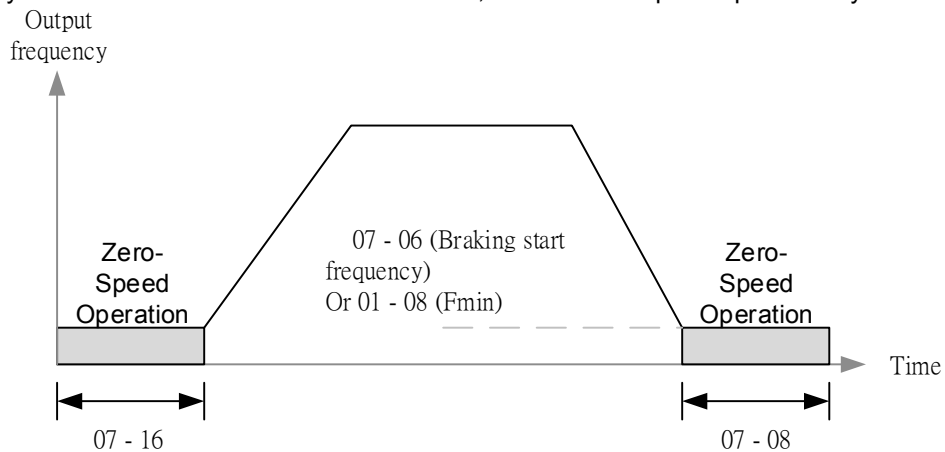

Figure 4.4.57c SV and PMSV zero-speed operation

**Note:** When 07-06 < 01-08, it starts zero-speed operation by the setting frequency (01-08)

<b>07-07</b>	<b>DC injection braking current</b>
<b>Range</b>	0~100 %

DC Injection braking current as percentage of the inverter rated current. Increasing this level will increase the amount of heat generated by the motor windings. Do not set this parameter higher than the level necessary to hold the motor shaft.

<b>07-08</b>	<b>DC injection braking time at stop</b>
<b>Range</b>	0.00~100.00 Sec

Duration of DC injection braking during a stop operation. DC injection braking at stop is disabled when parameter 07-08 is set to 0 sec.

<b>07-16</b>	<b>DC injection braking time at start</b>
<b>Range</b>	0.00~100.00 Sec

Duration of DC injection braking is during a start operation. DC injection braking at start is disabled when parameter 07-16 is set to 0 sec.

### DC Injection Braking Operation

When DC Injection braking is active DC voltage is applied to the motor, increasing the braking current and resulting in an increase in the strength of the magnetic field trying to lock the motor shaft.

To enable DC injection braking during a start operation set the DC injection braking current (07-07) and the DC injection braking time (07-16) at start to a value greater than 0. DC injection braking at start can be used to prevent “wind milling effect” in fan applications.

To enable DC injection braking during a stop operation set the DC injection braking current (07-07) and the DC injection braking time at stop (07-08) to a value greater than 0.

#### Notes:

- When parameter 07-16 is set to 0 sec (DC injection braking off). the inverter will start from the minimum output frequency.
- Increasing the DC braking time (07-08, 07-16) can reduce the motor stop time.
- Increasing the DC braking current (07-07) can reduce the motor stop time.
- During stop operation: If the DC braking start frequency < minimum output frequency (01-08), DC braking is activated when the output frequency reaches the minimum output frequency level.
- DC Injection braking cannot be used in sensor vector control (SV).

For DC braking operation, please refer to Figure 4.4.57.

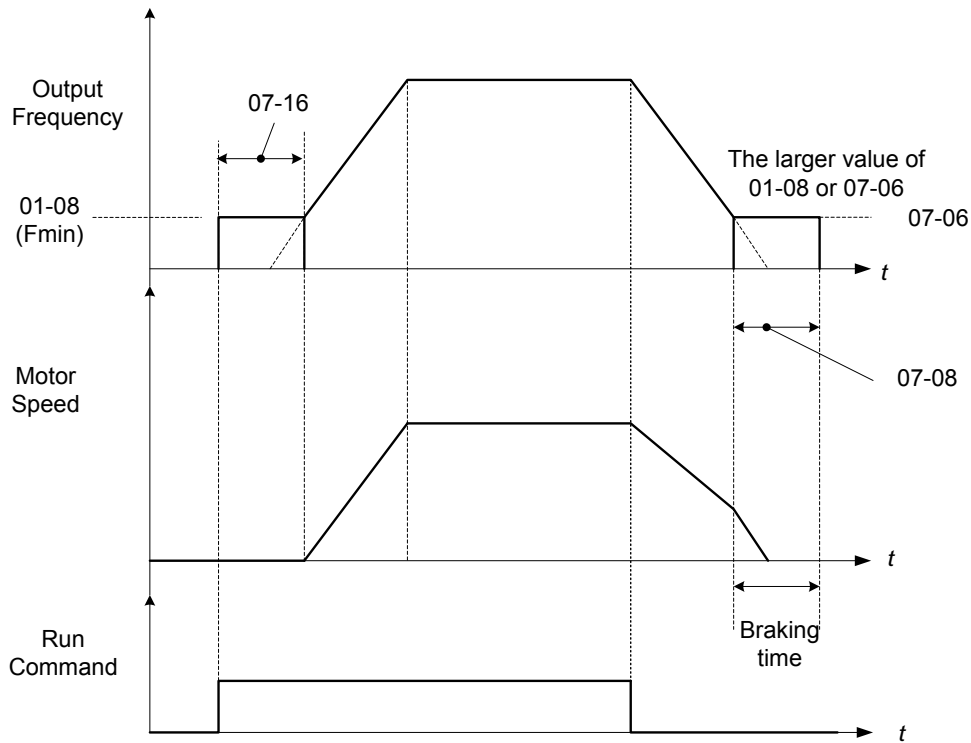

**Figure 4.4.58 DC braking operation**

DC braking operation can be controlled via any one of the multi-function input terminals (03-00 to 07) function 33. Refer to figure 4.4.58 for DC braking operation.

DC braking current can be controlled via the multi-function analog input (04-05) function 5. Refer to Figure 4.4.44.

<b>07-34</b>	Start short-circuit braking time
<b>Range</b>	<b>【0.00~100.00】 Sec</b>
<b>07-35</b>	Stop Short-circuit braking time
<b>Range</b>	<b>【0.00~100.00】 Sec</b>
<b>07-36</b>	Short-circuit braking current limited
<b>Range</b>	<b>【0.0~200.0】 %</b>

PMSLV is available for short-circuit braking. Short-circuit braking is the way to switch IGBT to produce braking torque. 07-06, 07-34 and 07-36 can adjust the braking process.

If 07-35=0, Inverter start from the minimum frequency.

The value of 07-36 is depend on differential motor rated current.(exe motor rated current is 5A, 07-36=100% is 5A)

03-00~03-07=65 can control Short-circuit braking.

<b>07-09</b>	<b>Stop mode selection</b>
<b>Range</b>	<b>0:</b> Deceleration to stop <b>1:</b> Coast to stop <b>2:</b> DC braking to stop <b>3:</b> Coast to stop with timer

When a stop command is issued the inverter stops according to the stop mode selected. There are four types of stop modes,

**Note:** DC braking stop (2) and coast to stop with timer (2) are not available in SV mode.

**07-09=0:** Deceleration to stop

When a stop command is issued, the motor will decelerate to the minimum output frequency (01-08)  $F_{min}$  and then stop. Deceleration rate depends on the deceleration time (factory default: 00-15).

When the output frequency reaches the DC braking stop frequency (07-06) or the minimum output frequency (01-08), DC injection braking is activated and the motor stops.

$$\text{Deceleration time} = \frac{\text{Output frequency when stop command is issued}}{\text{Maximum output frequency } F_{max} \text{ (01-02)}} \times \text{deceleration time setting}$$

**Note:** S curve setting will add to the overall stop time

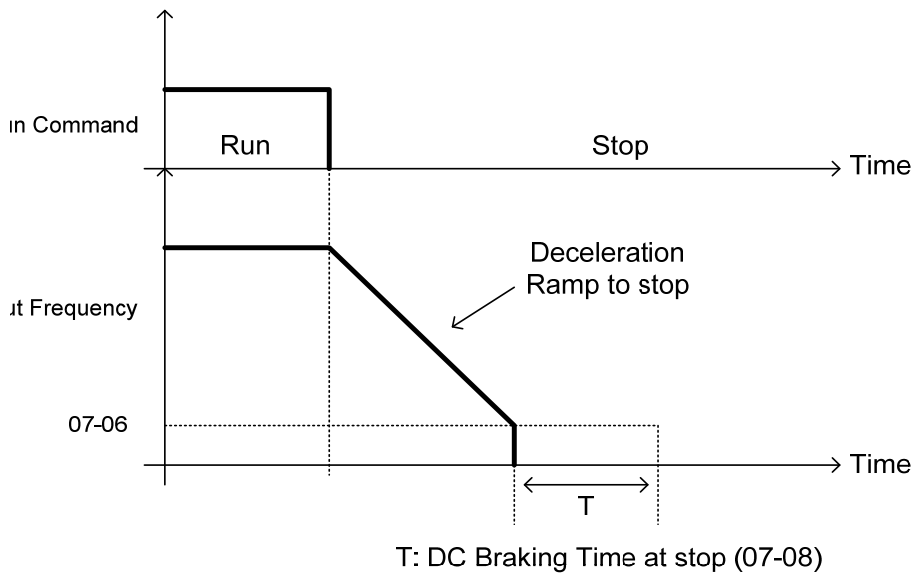

**Figure 4.4.59 Deceleration to stop**

**07-09=1:** Coast to stop

When a stop command is issued, the motor will coast to a stop. Stop time depends on motor load and friction of the system.

The inverter waits for the time set in the minimum baseblock time (07-18) before accepting the next run command.

In SLV mode (00-00=2) the speed search function is automatically enabled upon the next run command.

**Note:** When using a mechanical brake set parameter 07-26 to 1 (Software version 1.3 or later).

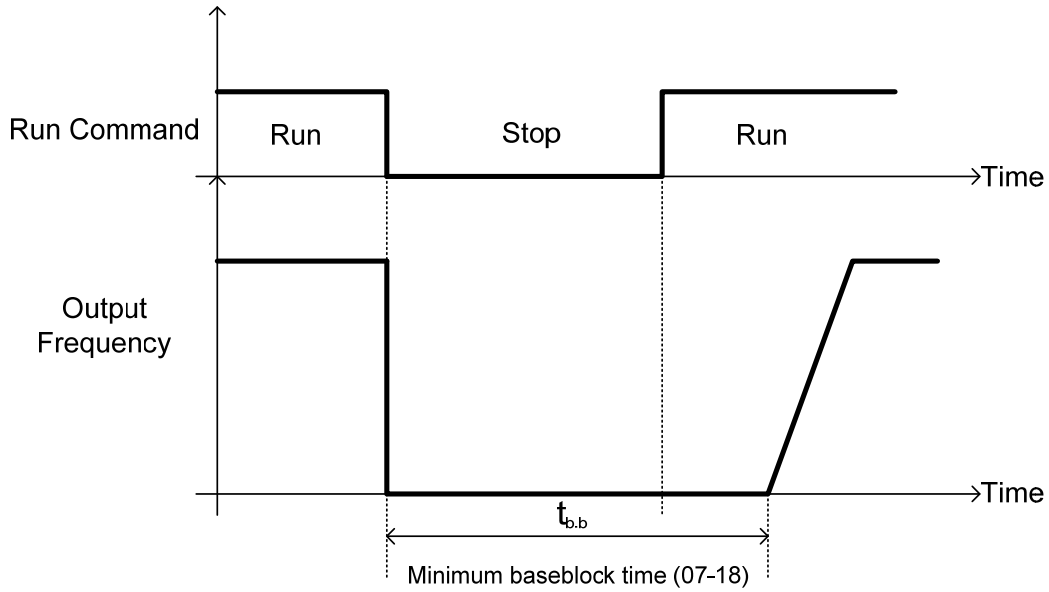

**Figure 4.4.60 Coast to stop**

**07-09=2: DC braking to stop**

When a stop command is issued, the inverter will turn off the output (Baseblock) and after the minimum Baseblock time (07-18) has expired activate DC braking (07-07). Refer to Figure 4.4.61.

The DC braking time ( $t_{DCDB}$ ) of Figure 4.4.61 is determined by the value of 07-08 (DC Braking start time) and the output frequency at the time the stop command was issued.

$$t_{DCDB} = \frac{(07-08) \times 10 \times \text{output frequency}}{F_{max} (01-02)}$$

Note: Increase the minimum Baseblock time (07-18) in case an Overcurrent trip occurs during the DC braking.

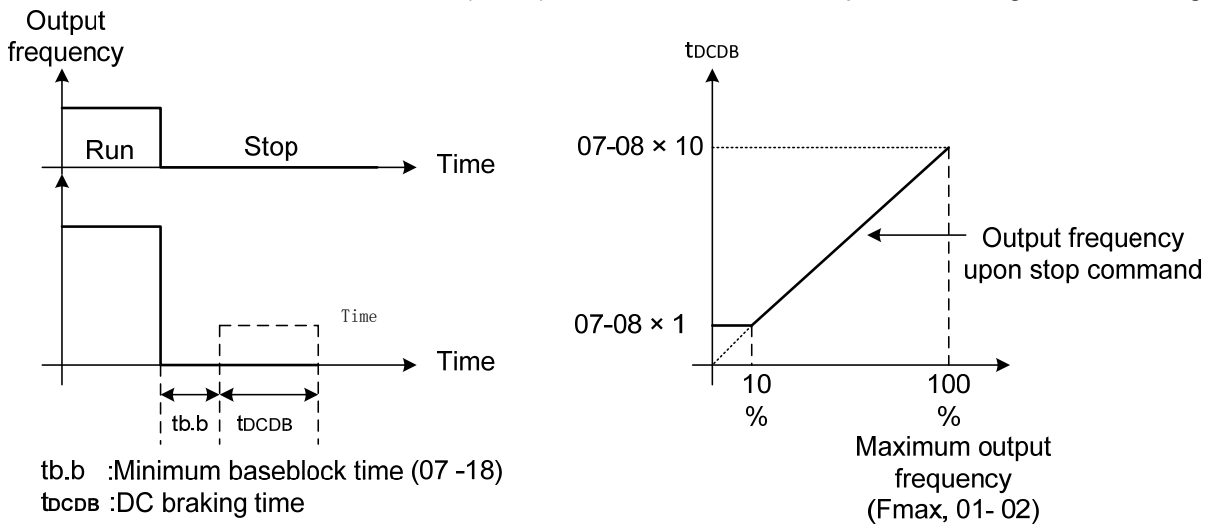
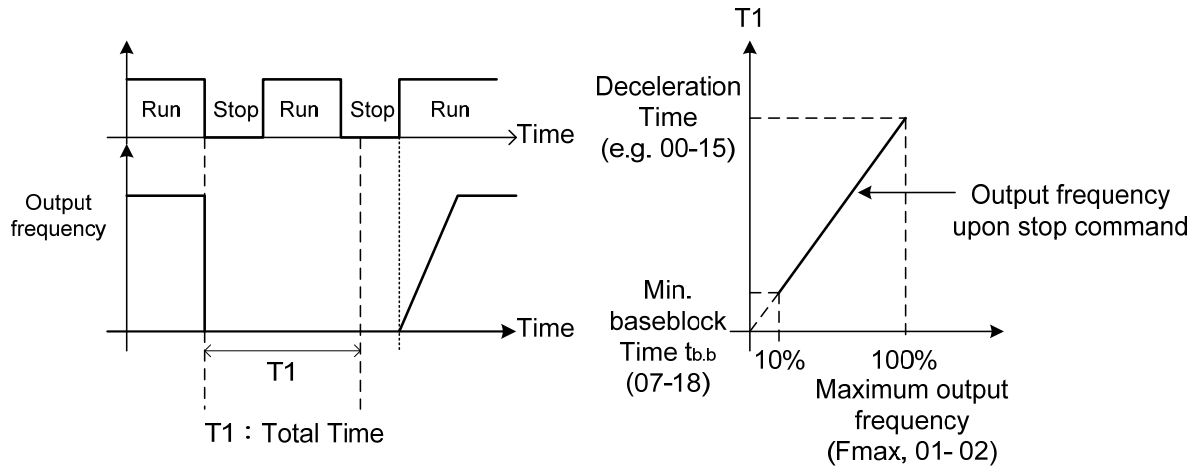

**Figure 4.4.61 DC braking to stop**

**07-09=3: Coast to stop with timer**

When a stop command is issued the motor will coast to a stop after the minimum Baseblock time (07-18) has expired. The inverter ignores the run command until the total time of the timer has expired.

The total time of the timer is determined by the deceleration time (00-15, 17, 22 or 24) and the output frequency upon stop. Refer to Figure 4.4.62



**Figure 4.4.62 Coast to stop with timer**

<b>07-13</b>	<b>Low voltage detection level</b>
<b>Range</b>	200V: 150~210Vdc 400V: 300~420Vdc 575V: 500~600Vdc 690V: 500~600Vdc

<b>07-25</b>	<b>Low voltage detection time</b>
<b>Range</b>	0.00~1.00 Sec

Adjust the 07-13 voltage level from 150 to 300 Vdc (200V class) or from 250 to 600 Vdc (400V class).

When the AC input voltage is lower than the 07-13 value (07-13/ 1.414 = AC voltage detection level) for the time specified in 07-25 the low-voltage error "UV" will displayed. If 07-25 = 0.00 sec., the UV error will be displayed immediately.

Set preventive measures:

- The inverter input voltage will limit the output voltage. If the input voltage drops excessively, or if the load is too big, the motor may stall.
- If the input voltage drops below the value set in 07-13 then the output is turned off momentarily. The inverter will not automatically start when power is restored.

<b>07-14</b>	<b>Pre-excitation time</b>
<b>Range</b>	0.00~10.00 Sec

<b>07-15</b>	<b>Pre-excitation level</b>
<b>Range</b>	50~200 %

If a high starting torque is required for the application, especially for a large horsepower motors, the pre-excitation operation can be used to pre-flux (magnetize) the motor.

#### **Pre-excitation time (07-14)**

When an operation command (forward or reverse) is activated, the inverter will automatically start pre-excitation based on the time set in parameter 07-14.

The time for the flux to reach 100% is a function value of motor's electrical time constant (See figure 4.4.63).

Electrical time constant (quadratic by-pass circuit time constant) can be calculated by motor parameter setting (group 02)

$$\text{Electrical time constant } T2 = \frac{\text{Motor leakage inductance (02-17) + motor mutual inductance (02-18)}}{\text{Motor rotor resistance (02-16)}}$$

Set the pre-excitation time (07-14) based on the electrical time constant T2

#### **Pre-excitation initial level (07-15)**

Use the pre-excitation initial level (07-15) to provide a higher excitation current during the pre-excitation time (07-14), which will increase the speed and stability for motors.

In order to quickly magnetize the motor, reduce the pre-excitation time (07-14) and set the pre-excitation level

(07-15) to a high level.

If 07-15 is set greater than 100%, providing a high excitation current during the pre-excitation time (07-14), motor's magnetization time is shortened. When the setting reaches 200%, magnetization is reduced by roughly half.

A high pre-excitation level (07-15) might result in excessive motor sound during pre-excitation.

When the flux reaches 100%, pre-excitation current reverts back to 100% and pre-excitation is completed.

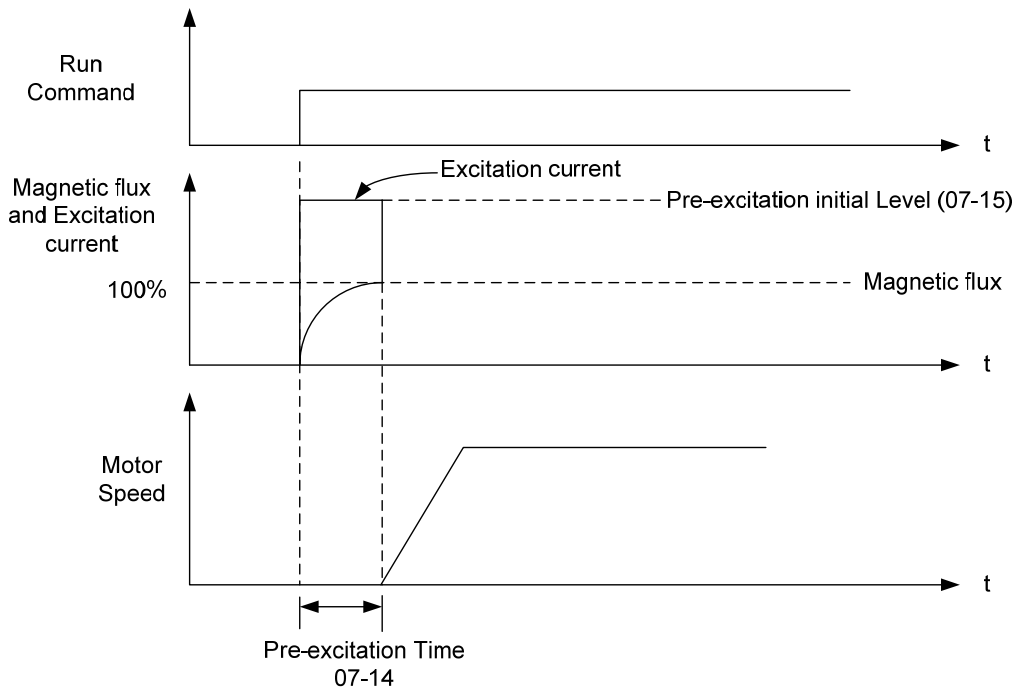

**Figure 4.4.63 Pre-excitation operation**



<b>07-18</b>	<b>Minimum base block time</b>
<b>Range</b>	0.1~5.0 Sec

In case of a momentary power failure, the inverter continues to operate after the power has been restored when parameter 07-00 is set to 1. Once the momentary power failure is detected; the inverter will automatically shut down the output and maintain B.B for a set time (07-18).

It is expected that after the minimum base block time has expired the residual voltage to be almost zero.

When the momentary power failure time exceeds the minimum base block time (07-18), the inverter will automatically perform a speed search upon return of power. Refer to the following figure 4.4.64.

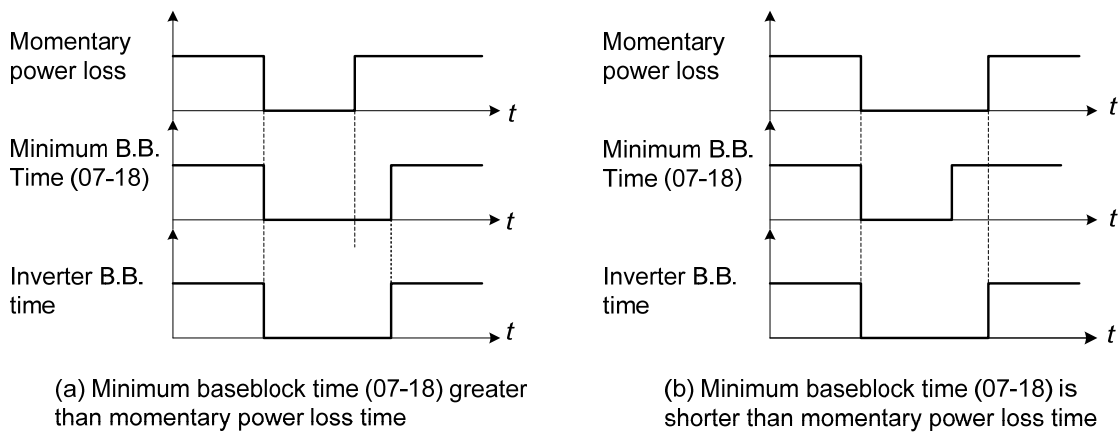

**Figure 4.4.64 Minimum B.B time and momentary power loss time**

Minimum base block time (07-18) is also used to for the DC braking function in combination with speed search as follows:

- Set the minimum base block time required (07-18).
- Execute speed search or DC braking function.
- Increase minimum Baseblock time if over-current "OC" condition occurs.
- After speed search is completed, normal operation continues.

<b>07-19</b>	<b>Speed Direction Search Operating Current</b>
<b>Range</b>	0~100 %

<b>07-20</b>	<b>Speed Search Operating Current</b>
<b>Range</b>	0~100 %

<b>07-21</b>	<b>Integral time of speed searching</b>
<b>Range</b>	0.1~10.0 Sec

<b>07-22</b>	<b>Delay time of speed searching</b>
<b>Range</b>	0.0~20.0 Sec
<b>07-23</b>	<b>Voltage recovery time</b>
<b>Range</b>	0.1~5.0 Sec
<b>07-24</b>	<b>Direction-Detection Speed Search Selection</b>
<b>Range</b>	0: Disable 1: Enable
<b>07-26</b>	<b>SLV Speed Search Function</b>
<b>Range</b>	0: Enable 1: Disable
<b>07-27</b>	<b>Start Selection after fault during SLV mode</b>
<b>Range</b>	0: Start with speed search 1: Normal start
<b>07-28</b>	<b>Start after external base block</b>
<b>Range</b>	0: Start with speed search 1: Normal start
<b>07-32</b>	<b>Speed Search Mode Selection</b>
<b>Range</b>	0: Disable 1: Mode1: Execute a Speed Search at Power On 2: Execute a Speed Search each time
<b>07-33</b>	<b>Start Frequency of Speed Search Selection</b>
<b>Range</b>	0: Maximum Output Frequency of Motor 1: Frequency Command

Speed search function is used to find the speed of a coasting motor and continue operation from that point. The speed search function is active after a momentary power loss. In V / F + PG or SV control mode (with PG control) speed search starts from the detected frequency (PG).

#### **Speed Search from Multi-function digital inputs**

Set the multi-function digital input to external speed search command 1 or 2. External speed search command 1 (value = 19) and 2 (value = 34) cannot be set at the same time, otherwise "SE02" (digital input terminal error) warning occurs.

Speed search function must be enabled before applying the run command to ensure proper operation. See relay logic in figure 4.4.65.

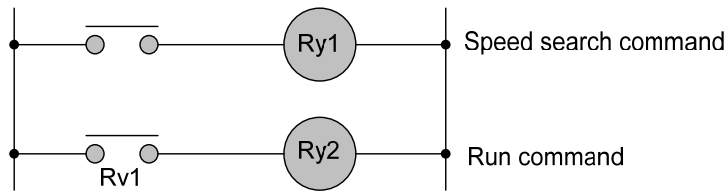

**Figure 4.4.65 Speed search and operation commands**

**Notes: Speed Search Operation**

- The speed search cannot be used when the motor rated power is greater than the inverter rated power.
- The speed search cannot be used when the motor rated power is two inverter sizes smaller than the inverter currently used.
- The speed search cannot be used in combination with a high-speed motor.
- If speed search function is used and the control mode is in V / F mode, it is necessary to perform a static auto-tune.
- If speed search function is used and the control mode is in SLV mode, it is necessary to perform a rotational auto-tune. Perform a static auto-tune when using long motor leads.

Speed search uses current detecting. Use parameter 07-24 to select detection direction.

**07-19: Speed Direction Search Operating Current**

- Used in bidirectional speed search only (07-24 = 1).
  - Set bidirectional current level.
  - Increase value if speed search is not successful at low speeds (above 5Hz)
- Note:** If value is too high may cause DC braking effect.

**07-20: Speed Search Operating Current**

- Can be used for bidirectional (07-24 = 1) or unidirectional (07-24 = 0) speed search.
- Sets speed search current Level.
- The set value must be lower than the excitation current (02-09) and must equal to the no-load current. If the no-load current is unknown it is recommended to set value at 20%.
- Excessive speed search current will cause inverter output to saturate.
- It is recommended to use speed search in case of a momentary power loss. Increase the minimum base block time (07-18) in case of an over-current condition.

**07-21: Integral time of speed searching**

- Can be used for bidirectional (07-24 = 1) or unidirectional (07-24 = 0) speed search.
- Set the integral time during speed search.
- If OV occurs, increase the set value to increase the speed search time. Decrease the value if a quick start is required

**07-22: Delay time of speed searching**

- Use delay time when using a contactor on the inverter output side.
- The inverter speed search starts after the delay time expires.
- Speed search delay time is disabled when set to 0.0 sec. (07-22 = 0.0)

**07-23: Voltage recovery time**

- Sets the voltage recovery time.
- Sets the time for the inverter to restore the output voltage from 0V to the specified V/f level after speed search function is completed.

**07-24: Direction-Detection Speed Search Selection****0: Disable Direction-Detection Speed Search**

Speed search is executed using speed search operating current defined in parameter 07-20. In case speed search is not successful (e.g. motor speed is too low) a speed search time-out warning is displayed. Set 07-19 to value greater than 0 to enable DC braking at speed search if a time-out occurs frequently.

**1: Enable Direction-Detection Speed Search**

At start the current controller will send a step current to the motor (07-19) to determine the motor direction. Once direction is determined the current controller will perform a speed search using speed search operating current defined in parameter 07-20. Speed search is executed after a momentary power loss (external speed search command 2, 03-00 to 03-07 = 34) or from max. frequency (external speed search command 1, 03-00 to 03-07 = 19). Speed search direction will follow the speed command.

**07-26: SLV Speed Search Function**

- In SLV mode (00-00 = 2) set the stop mode to the coast stop (07-09 = 1) or to the coast to stop with timer (07-09 = 3). After a stop command is issued (coast to stop or coast to stop with times) the speed search function is automatically activated for the next start.

**0: Enable** (No mechanical brake is installed)**1: Disable** (Mechanical brake is installed)**07-27: Start Selection after fault during SLV mode**

**0: Speed search start:** Speed search is executed after a fault in SLV mode.

**1: Normal start:** Speed search is not enabled.

**Note:** Set the parameter to 1 (normal start) after a fault has occurred and a mechanical brake is used to stop the motor.

**07-28: Start after external Baseblock**

**0: Speed search start:** Speed search is executed after base block is removed.

**1: Normal start:** Speed search is not enabled.

**Note:** Set parameter to 1 for control mode is V/F (00-00 = 0) or SLV mode (00-00 = 2) when the external base block active time is longer than the time the motor needs to come to a complete stop. After the external base block command is removed the inverter will accelerate from min. frequency.

### 07-32: Speed Search Mode Selection

**0: Disable:** The inverter start to run from the lowest output frequency but it won't limit the other functions of trigger speed search.

**1: Mode1: Execute a Speed Search at Power On:** The inverter executes a speed search at power on when entering first run command. It start the motor from found frequency.

**2: Execute a Speed Search each time: When PM motor performs speed search, it is recommended to reduce the set value of 20-00 and 20-02 at motor jittering.**

### 07-33: Start Frequency of Speed Search Selection

**0: Maximum Output Frequency of Motor:** The inverter start speed search from the maximum output frequency of motor.

**1: Frequency Command:** The inverter start speed search from setting frequency command.

#### ■ Speed search based on current detection

(a) Speed search at starting

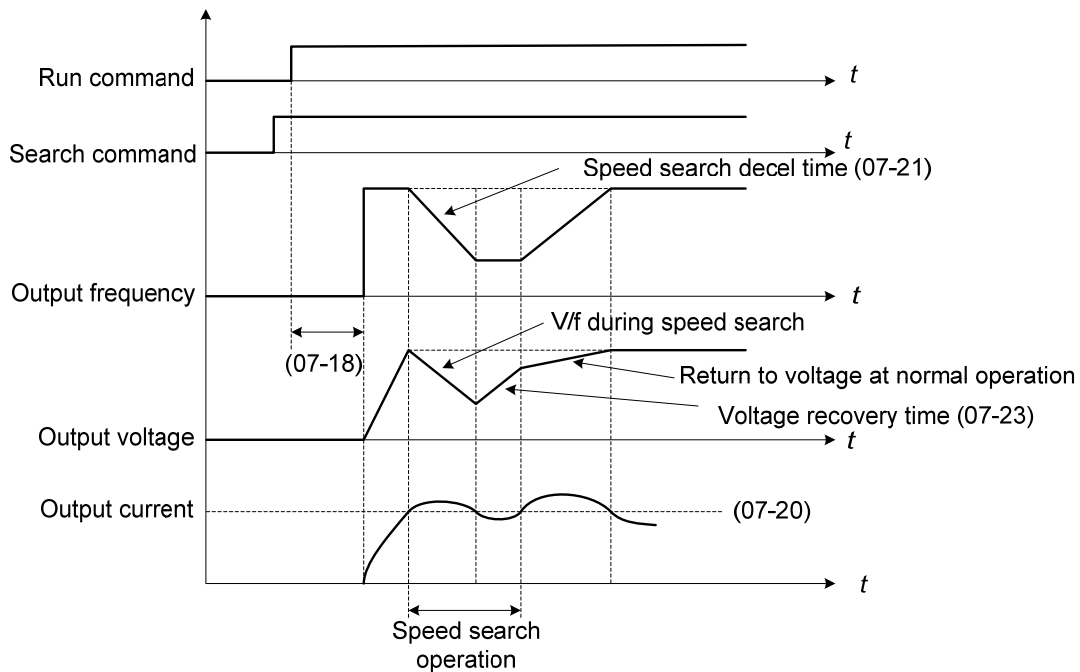

**Figure 4.4.66 Speed search at starting**

(b) Speed search in recovery period of momentary power failure

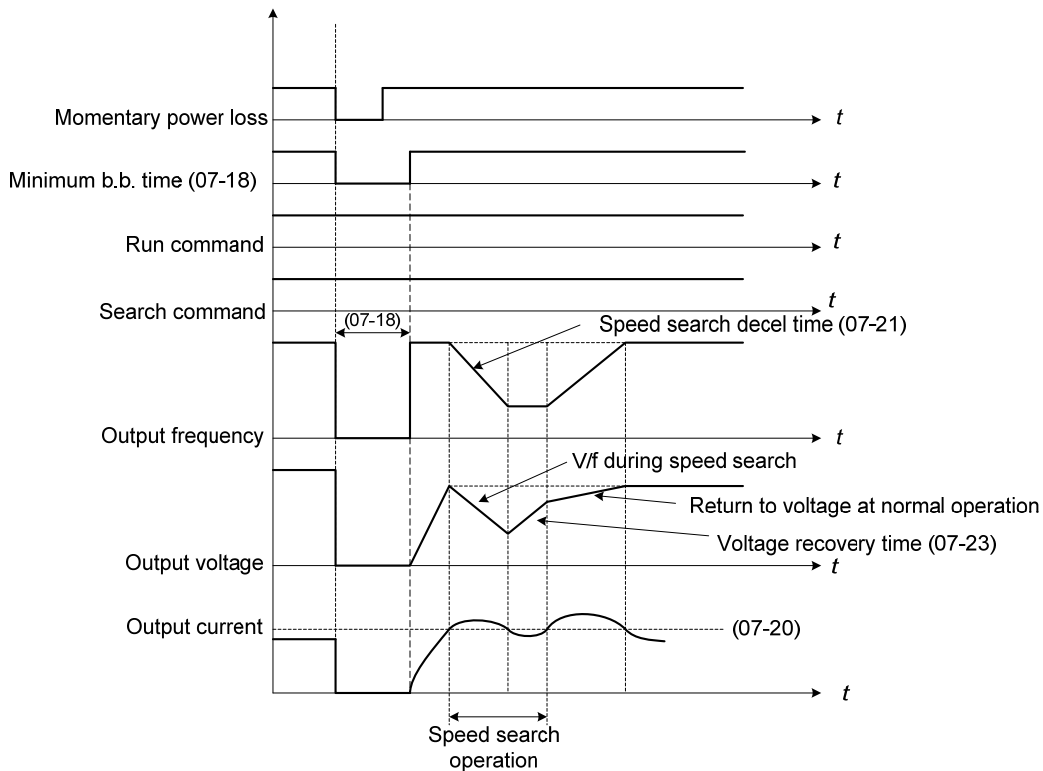

**Figure 4.4.67 Speed search in recovery period of momentary power failure**

**Notes:**

If the minimum base block time (07-18) is longer than the momentary power failure time, the speed search starts operation after the minimum base block time (07-18).

If the minimum base block time (07-18) is too short, the speed search operation begins immediately after power has been restored.

07-29	Run Command Selection at the Action of DC Braking
Range	<b>【0】 : Not Allowable to Run</b> <b>【1】 : Allowable to Run</b>

When DC braking is active, then:

**07-29=0:**

Inverter does not run again until DC braking stops.

**07-29=1:**

Inverter can run again even if DC braking is in action.

07-42	Voltage Limit Gain
Range	<b>【0.0~50.0】 %</b>

When the output voltage saturation causes the abnormal motor running and then jittering, user can increase the set value of 07-42 to limit the output voltage.

When the value of 07-42 is set too large, insufficient torque may occur. User can decrease the set value to improve this situation.

<b>07-43</b>	<b>Short-circuit Braking Time of PM Speed Search</b>
<b>Range</b>	<b>【0.00~100.00】 Sec</b>
<b>07-44</b>	<b>DC Braking Time of PM Speed Search</b>
<b>Range</b>	<b>【0.00~100.00】 Sec</b>

If the motor is in a rotating state due to inertia or the like and the rotation speed is far below the minimum speed control range, parameter 07-43 and 07-44 is set to perform the braking to stop motor and then restart.

If the motor is in a rotating state due to inertia or the like and the rotation speed is higher than the minimum speed control range, the inverter directly finds the frequency to start regardless of the set value of 07-43 or 07-44.

If parameters 07-43 and 07-44 are set to 0, the inverter finds the frequency to start after the speed search regardless of the motor's rotation speed.

<b>07-45</b>	<b>STP2 function selection</b>
<b>Range</b>	<b>【0】 : STP2 is enabled 【1】 : STP2 is disabled</b>

- If STP2 is enabled, when 00-02=1 and external operation signal is tripped, keypad will display "Terminal STOP" error when stop command comes from keypad.
- If STP2 is disabled, when 00-02=1 and external operation signal is tripped, keypad will not display "Terminal STOP" error when stop command comes from keypad.

<b>07-46</b>	<b>DC injection current limit</b>
<b>Range</b>	<b>0 ~ 150%</b>

In manual pulse generator mode, when the output frequency is lower than the minimum output frequency (01-08) of motor 1, the DC current will be injected to brake, the unit of this parameter is the percentage of the motor 1 rated current (02-01).

<b>07-47</b>	<b>PM Speed Switching Frequency Mode</b>
<b>Range</b>	<b>【0】 : Disabled 【1】 : Mode 1 【2】 : Mode 2</b>

If switch the three-speed speed switching according to the following figure, use the 00-25 (acceleration/deceleration switching frequency) ≠0 and 22-11 (I/f mode starting frequency switching point) parameters for frequency switching acceleration and deceleration:

Invalid: Please refer to the 00-25 parameter frequency for speed switching.

Mode 1: After the power is turned on, the speed can be switched, and the speed is switched according to the following figure.

Mode 2: The speed switching of the following figure can be realized only for the first operation, but the 22-11 switching will be invalid when decelerating.

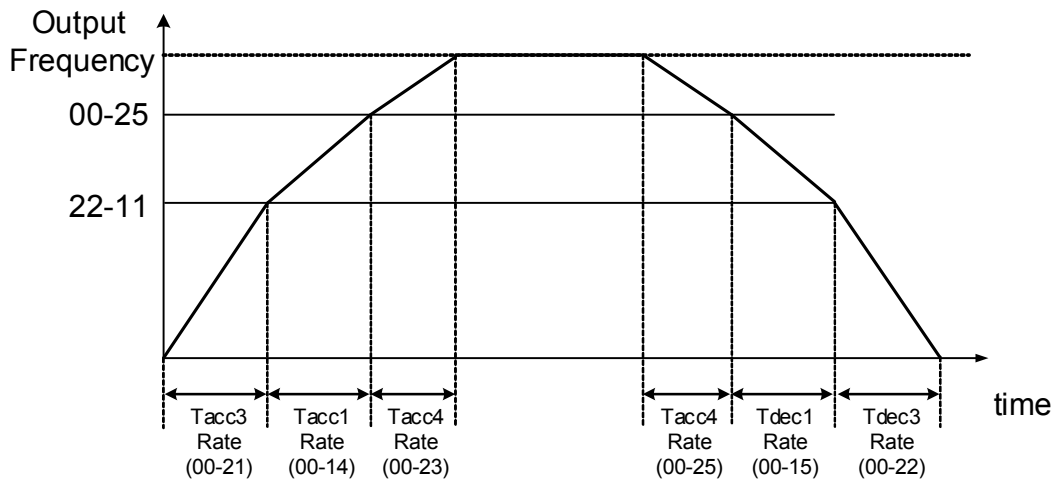

Note: When 00-25≠0, the switching frequency can't be less than the 22-11 parameter frequency setting, and this parameter is enabled only in PMSLV mode.



## 08-Protection Parameters

<b>08-00</b>	<b>Stall prevention function.</b>
<b>Range</b>	<b>xxx0b:</b> Stall prevention function is enabled during acceleration. <b>xxx1b:</b> Stall prevention function is disabled during acceleration. <b>xx0xb:</b> Stall prevention function is enabled during deceleration. <b>xx1xb:</b> Stall prevention function is disabled during deceleration. <b>x0xxb:</b> Stall prevention function is enabled during operation. <b>x1xxb:</b> Stall prevention function is disabled during run. <b>0xxxb:</b> Stall prevention function during run is based on the first deceleration time. <b>1xxxb:</b> Stall prevention function during run is based on the second deceleration time.
<b>08-01</b>	<b>Stall prevention level during acceleration</b>
<b>Range</b>	20~200 %
<b>08-02</b>	<b>Stall prevention level during deceleration</b>
<b>Range</b>	200V: 330V~410V 400V: 660V~820V 575V: 900~1000 V 690V: 1080~1200 V
<b>08-03</b>	<b>Stall prevention level during run</b>
<b>Range</b>	30~200 %
<b>08-21</b>	<b>Limit of stall prevention during acceleration</b>
<b>Range</b>	1~100 %
<b>08-22</b>	<b>Stall prevention detection time during run</b>
<b>Range</b>	2~100 msec
<b>08-40</b>	<b>Motor2 acceleration stall prevention level</b>
<b>Range</b>	20~200 %
<b>08-41</b>	<b>Motor2 acceleration stall prevention limit</b>
<b>Range</b>	1~100 %

**Note:** Stall prevention function only can be set in V/F control mode.

### Stall prevention during acceleration (08-00=xxx0b)

- (1) Prevents the inverter from faulting (Overcurrent, Motor overload, Inverter overload) when accelerating with heavy loads.
- (2) When the inverter output current reaches the level set in parameter 08-01 minus 15% the acceleration rate starts to decrease. When the inverter output current reaches the level set in parameter 08-01 the motor stops accelerating.
- (3) Reduce stall prevention level during acceleration (08-01) in case the motor stalls (when the motor power is smaller than the inverter rating).

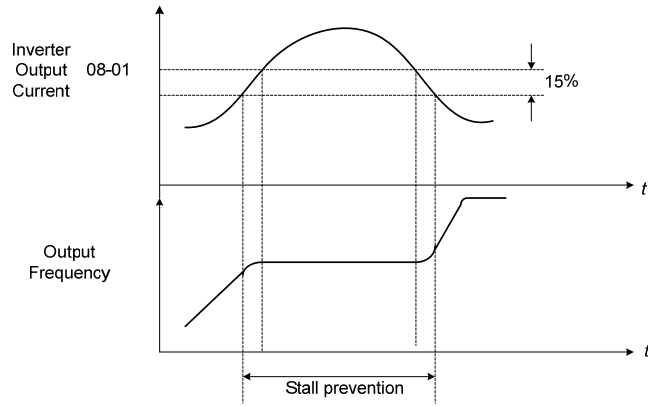

**Figure 4.4.68 Stall prevention during acceleration**

If the motor is used in the constant power (CH) region, the stall prevention level (08-01) is automatically reduced to prevent the stall.

Stall prevention level during acceleration (Constant horsepower)

$$\text{Stall Prev. Lev. Acceleration (CH)} = \frac{\text{Stall prevention level in acceleration (08-01)} \times \text{Fbase (01-12)}}{\text{Output frequency}}$$

Parameter 08-21 is the stall prevention limit value in Constant Horsepower region. Refer to figure 4.4.69.

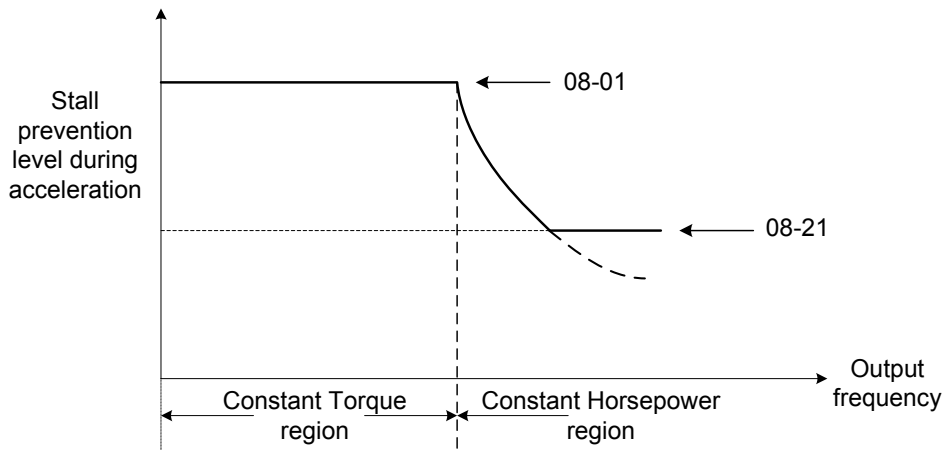

**Figure 4.4.69 Stall prevention level and limit in acceleration**

Motor2 Acceleration Stall Prevention Level (08-40) and Motor2 Acceleration Stall Prevention Limit (08-41) are Used when 03-00~03-07=40 (Switching between Motor 1/Motor 2)

**Stall prevention selection during deceleration (08-00=xx0xb)**

Stall prevention during deceleration automatically increases the deceleration time according based on the DC-bus voltage to prevent over-voltage during deceleration. Refer to Figure 4.4.69 for stall prevention during deceleration

When the DC-bus voltage exceeds the stall prevention level deceleration will stop and the inverter will wait for the DC-bus voltage to fall below the stall prevention level before continuing deceleration. Stall prevention level can be set by 08-02, see Table 4.4.34.

**Table 4.4.34 Stall prevention level**

Inverter model	08-02 default value
200V class	385VDC
400V class	770VDC
575V class	950VDC
690V class	1140VDC

**Note:** When using external braking (braking resistor or braking module) disable stall prevention during deceleration (08-00 to xx1xb).

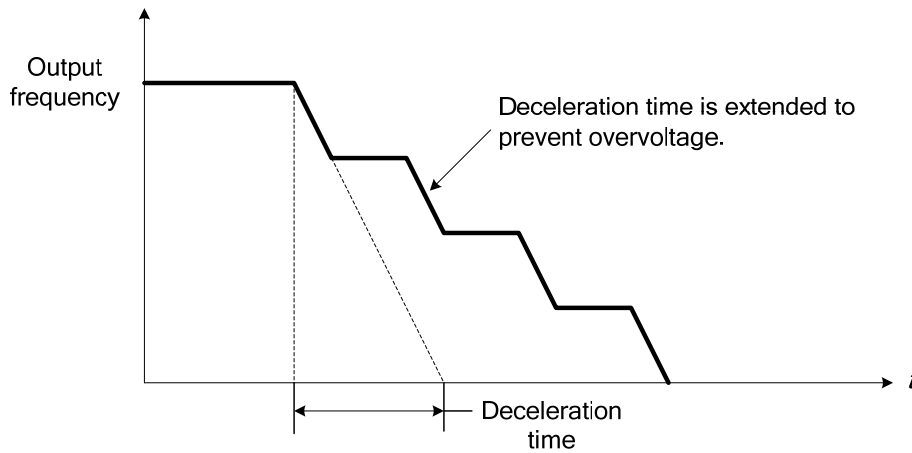

**Figure 4.4.70 Stall prevention selection in deceleration**

**Stall prevention selection during run (08-00=x0xxb)**

Stall prevention during run can only be used in V/F or V/F + PG and SLV2 control mode.

This function prevents the motor from stalling by automatically reducing the output frequency during run.

If the inverter output current rises above the level set in parameter 08-03 for the time specified in parameter 08-22, the inverter output frequency is automatically decreased following deceleration time 1 (00-15) or deceleration time 2 (00-17).

When the inverter output current falls below the level set in parameter (08-03) minus 2%, normal operation continues and the output frequency increases to the frequency reference using the acceleration time 1 or acceleration time 2. Refer to the following figure 4.4.71.

**Note:** The stall prevention level during run can be set by using multi-function analog input AI2 (04-05=7).

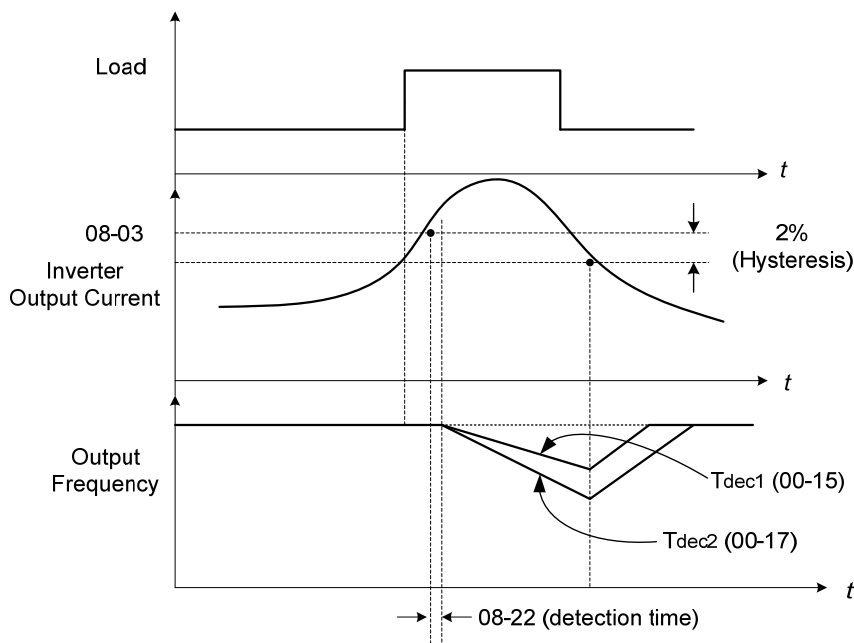

Figure 4.4.71 Stall prevention selection in operation

**Note:**

Stall prevention level in operation is set by multi-function analog input AI2 (04-05=7).

<b>08-05</b>	<b>Selection for motor overload protection (OL1)</b>
<b>Range</b>	<b>xxx0b</b> : Motor overload is disabled <b>xxx1b</b> : Motor overload is enabled <b>xx0xb</b> : Cold start of motor overload <b>xx1xb</b> : Hot start of motor overload <b>x0xxb</b> : Standard motor <b>x1xxb</b> : Special motor <b>0xxxb</b> : Reserved <b>1xxxb</b> : Reserved
<b>08-07</b>	<b>Motor Overload (OL1) Protection Level</b>
<b>Range</b>	<b>[0]</b> : Motor Overload (OL1) Protection 0 <b>[1]</b> : Motor Overload (OL1) Protection 1 <b>[2]</b> : Motor Overload (OL1) Protection 2

The motor overload protection function estimates the motor overload level based on the output current, output frequency, motor characteristics and time. The motor overload trip time depends on the motor rated current when the output frequency is greater than 60Hz.

On inverter power-up the motor overload protection internal thermal accumulation register is automatically reset.

To use the built-in motor overload protection function parameter 02-01 (motor rated current) has to match the motor rated current on the motor nameplate.

Turn off the motor overload protection when using two or more motors connected to the inverter (set 08-05 = xxx0b), and provide external overload protection for each motor (e.g. thermal overload switch).

With cold start enabled (08-05 = xx0xb), motor overload protection occurs in 5 and a half minutes when operating the motor at 150% of the motor rated current at an output frequency greater than 60Hz.

With hot start enabled (08-05 = xx1xb), motor overload protection occurs in 3 and a half minutes when operating the motor at 150% of the motor rated current at an output frequency greater than 60Hz.

Refer to the following figure 4.4.72 for an example of motor overload protection standard curve. And refer to the setting of 08-07 (Motor overload (OL1) protection level), the overload curve will be different.

**08-07=0:**

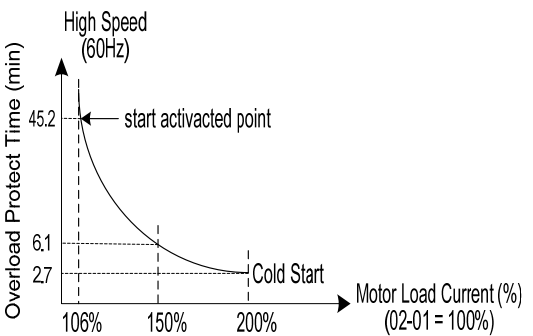
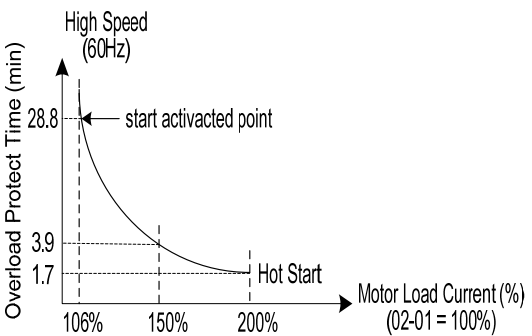
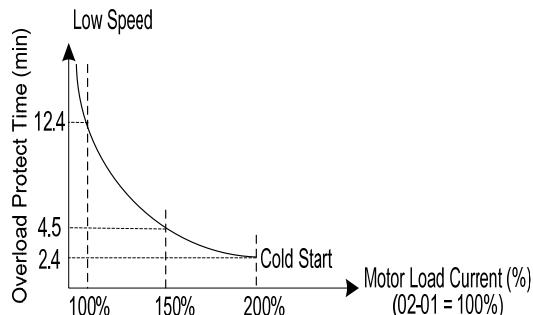
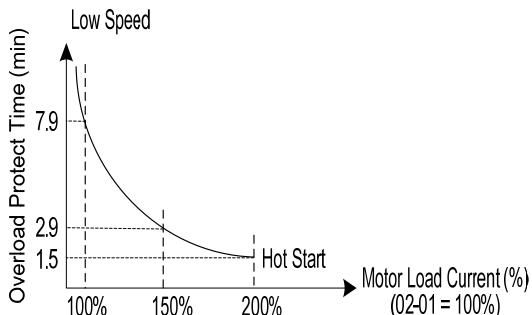

**08-07=1:**

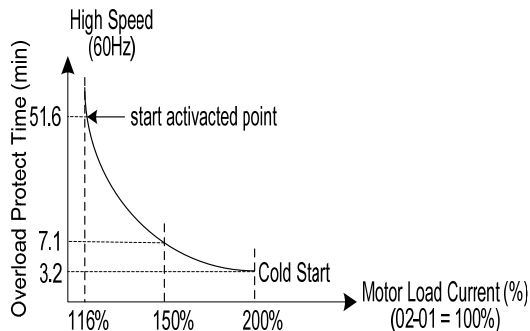
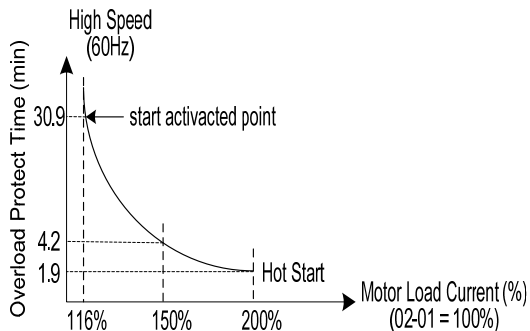
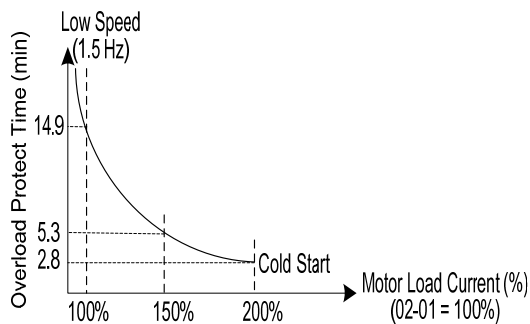
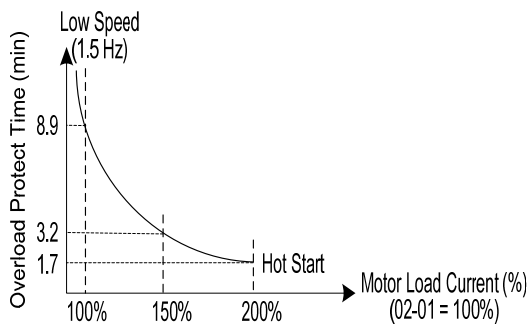

08-07=2:

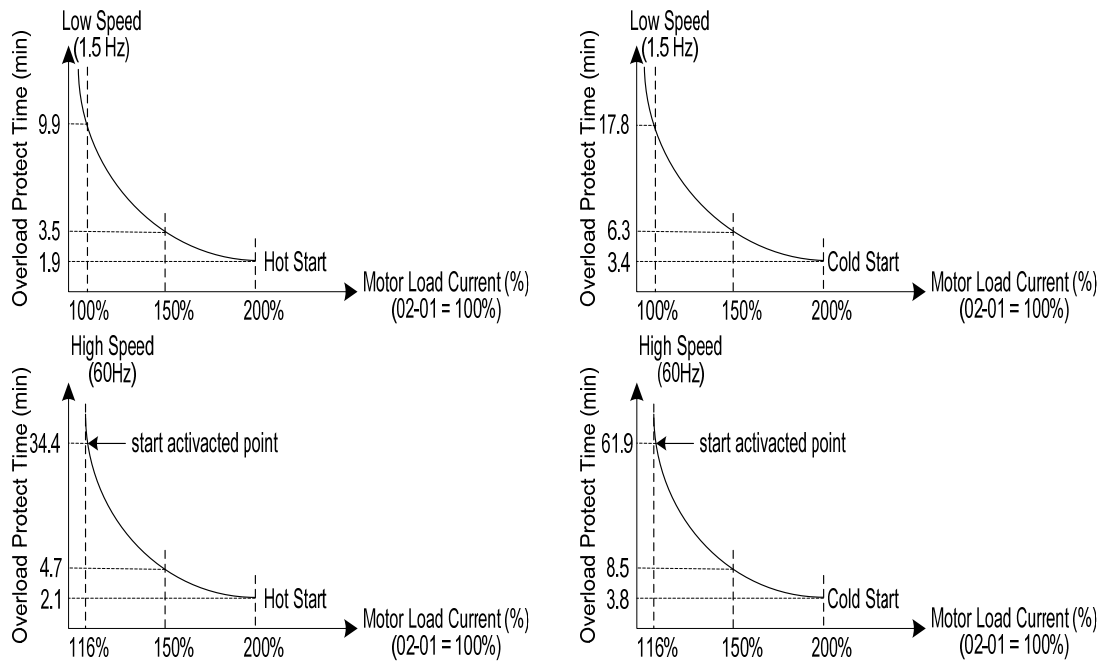

**Figure 4.4.72 Motor overload protection curve (example: standard motor)**

When using force cooled motors (Special inverter motor), thermal characteristics are independent of the motor speed, set 08-05 = x1xxb.

When 08-05 = x1xxb, overload protection function is based on motor rated current for output frequencies between 6 and 60Hz. If the output frequency is lower than 1Hz, the overload protection function uses 83% of the motor rated current to determine an overload condition.

When 08-05 = x0xxb, overload protection function is based on 70% of the motor rated current for an output frequency of 20Hz. If the output frequency is lower than 1Hz, the overload protection function uses 40% of the motor rated current to determine an overload condition.

Motor overload rating at different output frequencies is shown at Figure 4.4.73.

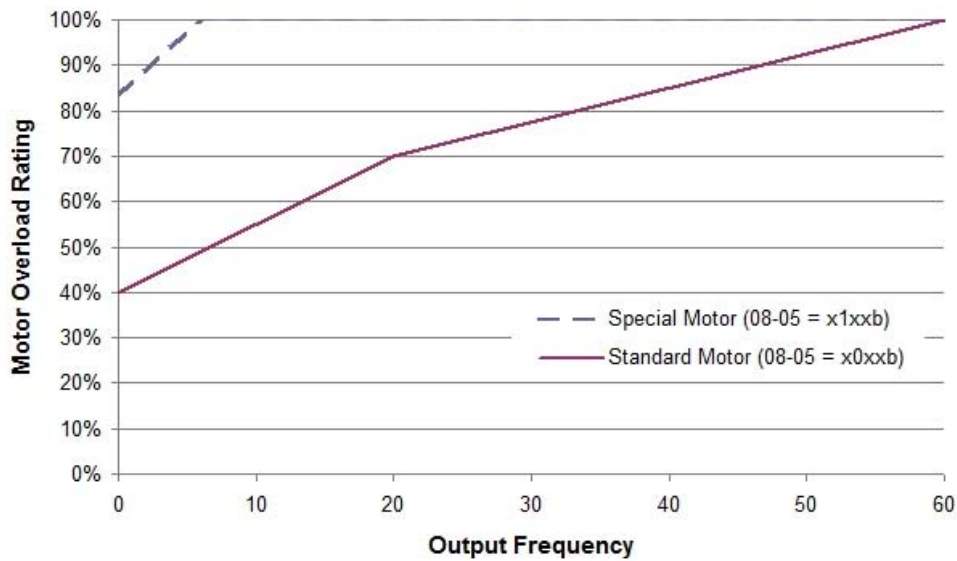

Figure 4.4.73 Motor overload rating at different output frequencies

<b>08-06</b>	<b>Start-up mode of overload protection operation (OL1)</b>
<b>Range</b>	<b>0:</b> Stop output after overload protection <b>1:</b> Continuous operation after overload protection.

**08-06=0:** When the inverter detects a motor overload the inverter output is turned off and the OL1 fault message will display on the keypad. Press RESET button on the keypad or activate the reset function through the multi-function inputs to reset the OL1 fault.

**08-06=1:** When the inverter detects a motor overload the inverter will continue running and the OL1 alarm message will flash on the keypad until the motor current falls within the normal operating range.

<b>08-08</b>	<b>Automatic voltage regulation (AVR)</b>
<b>Range</b>	<b>0:</b> AVR is enabled <b>1:</b> AVR is disabled

Automatic voltage regulation stabilizes the motor voltage independent of fluctuation to the input voltage.

**08-08=0:** Automatic voltage regulation is active. It will limit the maximum output voltage. When input three-phase voltage fluctuates and the voltage is smaller than the value of 01-14, the output voltage will fluctuate with the fluctuation of input voltage.

**08-08=1:** Automatic voltage regulation is not active, motor voltage follows the input voltage fluctuation. When input three-phase voltage fluctuates, the output voltage won't fluctuate with the fluctuation of input voltage.

<b>08-09</b>	<b>Selection of input phase loss protection</b>
<b>Range</b>	<b>0:</b> Disable <b>1:</b> Enable

**08-09=0:** Input phase loss detection is disabled.

**08-09=1:** Input phase loss detection is enabled. Keypad shows "IPL input Phase Loss" (IPL), when an input phase loss is detected the inverter output is turned off and the fault contact is activated.

**Note:** The input phase loss detection is disabled when the output current is less than 30% of the inverter rated current.

<b>08-10</b>	<b>Selection of output phase loss protection</b>
<b>Range</b>	<b>0:</b> Disable <b>1:</b> Enable

**08-10=0:** Output phase loss detection is disabled.

**08-10=1:** Output phase loss detection is enabled. Keypad shows "OPL Output Phase Loss" (OPL), when an output phase loss is detected and the inverter output is turned off and the fault contact is activated.

**Note:** The output phase loss detection is disabled when the output current is less than 10% of the inverter rated current.

<b>08-13</b>	<b>Selection of over-torque detection</b>
<b>Range</b>	<b>0:</b> Over-torque detection is disabled <b>1:</b> Start to detect when reaching the set frequency <b>2:</b> Start to detect when the operation is begun

<b>08-14</b>	<b>Selection of over-torque action</b>
<b>Range</b>	<b>0:</b> Deceleration to stop when over-torque is detected. <b>1:</b> Displays warning when over-torque is detected. Continue operation. <b>2:</b> Coast to stop when over-torque is detected

<b>08-15</b>	<b>Level of over-torque detection</b>
<b>Range</b>	0~300 %

<b>08-16</b>	<b>Time of over-torque detection</b>
<b>Range</b>	0.0~10.0 Sec

<b>08-17</b>	<b>Selection of low-torque detection</b>
<b>Range</b>	<b>0:</b> Low-torque detection is disabled <b>1:</b> Start to detect when reaching the set frequency <b>2:</b> Start to detect when the operation is begun

<b>08-18</b>	<b>Selection of low-torque action</b>
<b>Range</b>	<b>0:</b> Deceleration to stop when low-torque is detected <b>1:</b> Display warning when low-torque is detected. Go on operation <b>2:</b> Coast to stop when under-torque is detected



<b>08-19</b>	<b>Level of low-torque detection</b>
<b>Range</b>	0~300%

<b>08-20</b>	<b>Time of low-torque detection</b>
<b>Range</b>	0.0~10.0 Sec

The over torque detection function monitor the inverter output current or motor torque and can be used to detect increase in inverter current or motor torque (e.g. heavy load).

The low torque detection function monitor the inverter output current or motor torque and can be used to detect a decrease in inverter current or motor torque (e.g. belt break).

The torque detection levels (08-15, 08-19) are based on the inverter rated output current (100% = inverter rated output current) when operating the inverter in V/F control or V/F control + PG and motor output torque (100% = motor rated torque) when operating the inverter in SLV or SV control.

### Over-torque detection

Parameter 08-13 selects over-torque detection function. An over-torque condition is detected when the output current / torque rises above the level set in parameter 08-15 (Over-torque detection level) for the time specified in parameter 08-06 (Over-torque detection time).

**08-13=0:** Over-torque detection is disabled.

**08-13=1:** Over-torque detection is enabled when the output frequency reaches the set frequency.

**08-13=2:** Over-torque detection is enabled during running.

Parameter 08-14 selects the way the inverter acts when an over-torque condition is detected.

**08-14=0:** When an over-torque condition is detected the inverter displays an over-torque detection fault and the motor decelerates to a stop.

**08-14=1:** When an over-torque condition is detected the inverter displays an over-torque detection alarm and continues to run.

**08-14=2:** When an over-torque condition is detected the inverter displays an over-torque detection fault and the motor coasts to a stop.

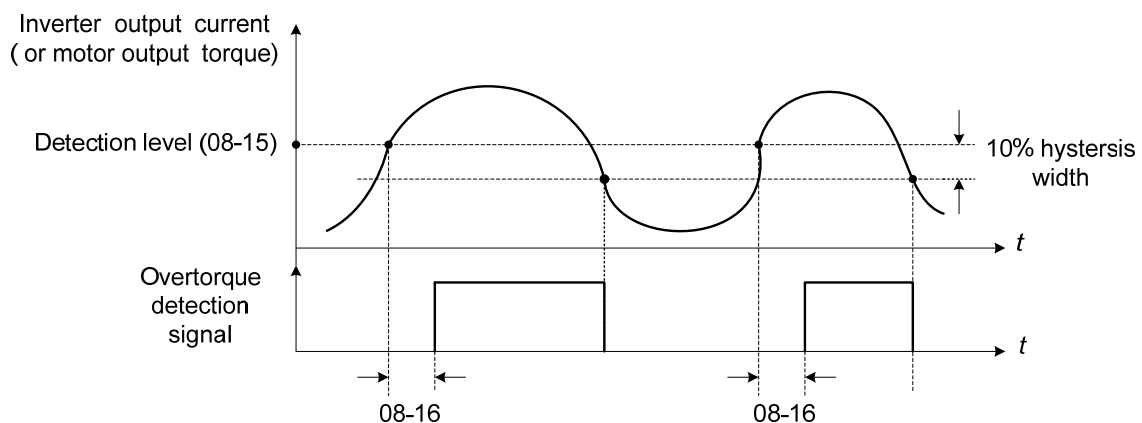

**Figure 4.4.74 Over-torque detection operation**

## Low-torque detection

Parameter 08-18 selects low-torque detection function. An low-torque condition is detected when the output current / torque falls below the level set in parameter 08-19 (low-torque detection level) for the time specified in parameter 08-20 (Low-torque detection time).

**08-17=0:** Low-torque detection is disabled.

**08-17=1:** Low-torque detection is enabled when the output frequency reaches the set frequency.

**08-17=2:** Low-torque detection is enabled during running.

Parameter 08-18 selects the way the inverter acts when an over-torque condition is detected.

**08-18=0:** When a low-torque condition is detected the inverter displays and low-torque detection fault and the motor decelerates to a stop.

**08-18=1:** When a low-torque condition is detected the inverter displays a low-torque detection alarm and continues to run.

**08-18=2:** When a low-torque condition is detected the inverter displays and low-torque detection fault and the motor coasts to a stop

. Setting Example of less torque detection:

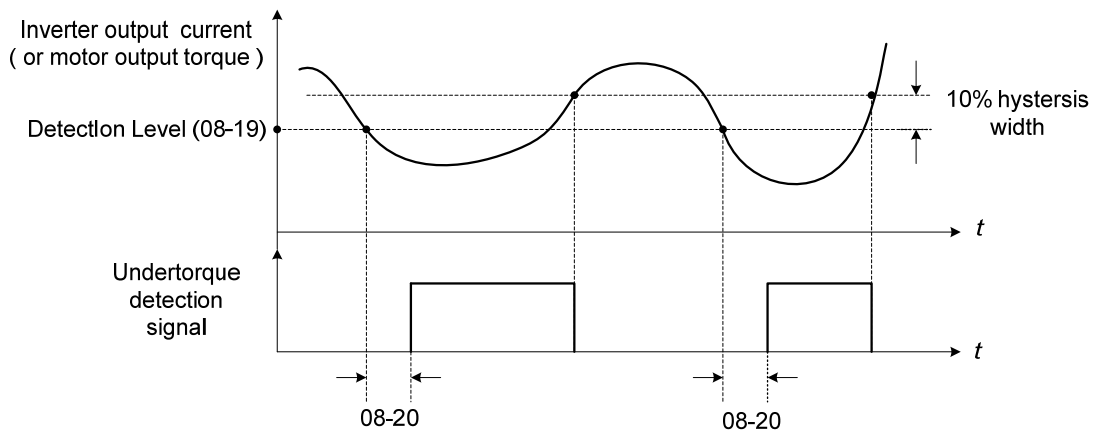

**Figure 4.4.75 Low torque detection operation**

Over and low torque detection condition can be output to the multi-function digital outputs (R1A-R1C, R2A-R2C) by setting parameters 03-11 to 03-12 to 12 or 25. Refer to figure 4.4.76 for more information.

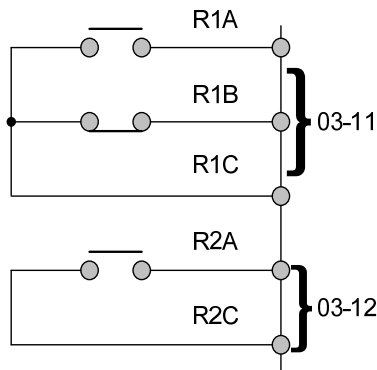

**Figure 4.4.76 Over-torque / low torque detection multi-function digital output terminal**

<b>08-23</b>	<b>Ground Fault (GF) selection</b>
<b>Range</b>	<b>0:</b> Disable <b>1:</b> Enable

**08-23=1:**

If the inverter leakage current is greater than 50% of inverter rated current and the ground fault function is enabled (08-23), the keypad will display a "GF Ground Fault" (GF), motor will coast to a stop and fault contact is activated.

<b>08-24</b>	<b>External fault operation selection</b>
<b>Range</b>	<b>0:</b> Deceleration to stop <b>1:</b> Coast to stop <b>2:</b> Continue operation

Select operation selection when an external fault occurs. Refer to the multi-function inputs on how to set up the inverter for an external fault input.

<b>08-25</b>	<b>Detection selection of external fault</b>
<b>Range</b>	<b>0:</b> Immediately detect when the power is supplied <b>1:</b> Start to detect during operation

**08-25=0:** When the inverter is supplied by power, detection external fault function will execute.

**08-25=1:** When the inverter is start to run, detection external fault function will execute.

<b>08-30</b>	<b>Run permissive function selection</b>
<b>Range</b>	<b>0:</b> Deceleration to stop <b>1:</b> Coast to stop

When 03-00~03-07=58, the inverter will stop by the set of 08-30

<b>08-37</b>	<b>Fan control function</b>
<b>Range</b>	<b>0:</b> Start in operation <b>1:</b> Permanent start <b>2:</b> Start in high temperature (except of the models of 2050, 4100 or the above)
<b>08-38</b>	<b>Delay time of fan off</b>
<b>Range</b>	0~600 sec

**08-37=0:** The inverter start to run and the fan will follow to run. If the inverter stop and the time is longer than the value of 08-38, the fan stop. If the temperature for heat sink is higher than the temperature of inside-detection and the inverter doesn't run, the fan will start run automatically.

**08-37=1:** The inverter is supplied by power, the fan start to run.

**08-37=2:** The temperature for heat sink is higher than the temperature of inside-detection, the fan start to run. After the temperature for heat sink is lower than the temperature of inside-detection and the time is over 08-38, the fan stop.

**Note:** There is no 08-37=2 for the models of 2050, 4100 or the above.

<b>08-35</b>	<b>Motor overheat fault selection</b>
<b>Range</b>	0: Disable 1: Deceleration to stop 2: Free run to top 3: Continue running
<b>08-36</b>	<b>PTC input filter time constant</b>
<b>Range</b>	0.00 ~ 5.00 sec
<b>08-39</b>	<b>Delay time of motor overheat protection</b>
<b>Range</b>	1~300 sec
<b>08-42</b>	<b>PTC protection level</b>
<b>Range</b>	0.1~10.0V
<b>08-43</b>	<b>PTC restart level</b>
<b>Range</b>	0.1~10.0V
<b>08-44</b>	<b>PTC warning level</b>
<b>Range</b>	0.1~10.0V

### Motor overheat fault selection

It execute motor overheat protection by the resistor (PTC) that built-in the motor.  
the resistor (PTC) is between AI2 and GND and a divided resistor R ,as the pic 4.3.65(b)

**08-35=0:** Motor overheats fault function is off.

**08-35=1:** When the motor is overheating, it decelerates to stop.

**08-35=2:** When the motor is overheating, it free runs to stop.

**08-35=3:** When the motor is overheating, it does not stop running until reach the value of 08-42.

**08-35=1、2:** When the temperature is getting higher for the motor and AI2 voltage level is higher than the value of 08-44, the display will show 『OH4 Motor Overheating』 and the motor will stop by 08-35=1、2.

**08-35=3:** When the temperature is getting higher for the motor and AI2 voltage level is higher than the value of 08-44, the display will show 『OH3 Motor Temp Warning』 but the motor continues running. But AI2 voltage level is higher than the value of 08-42 and the time reach to 08-39, the motor free runs to stop.

**08-35=1、2、3:** When the motor cools down and AI2 voltage level is lower the value of 08-43, 『OH4 Motor overheat』 will reset.

**Note:** The resistor (PTC) conform the British Standards Institution:

When Tr is 150 °C in Class F and is 180°C in Class H ◦

Tr- 5°C :  $RT \leq 550\Omega$  , put the value of RT in formula (1), the V value by calculation is the value of 08-43.

Tr+ 5°C :  $RT \geq 1330\Omega$  , put the value of RT in formula (1), the V value by calculation is the value of 08-44.

It gets reference value by using formula (1) even in the different spec of resistor (PTC).

$$V = \frac{1}{2} \times 10 \times \frac{R_{PTC} // 200}{R + (R_{PTC} // 200)} \quad \text{----- Formula (1)}$$

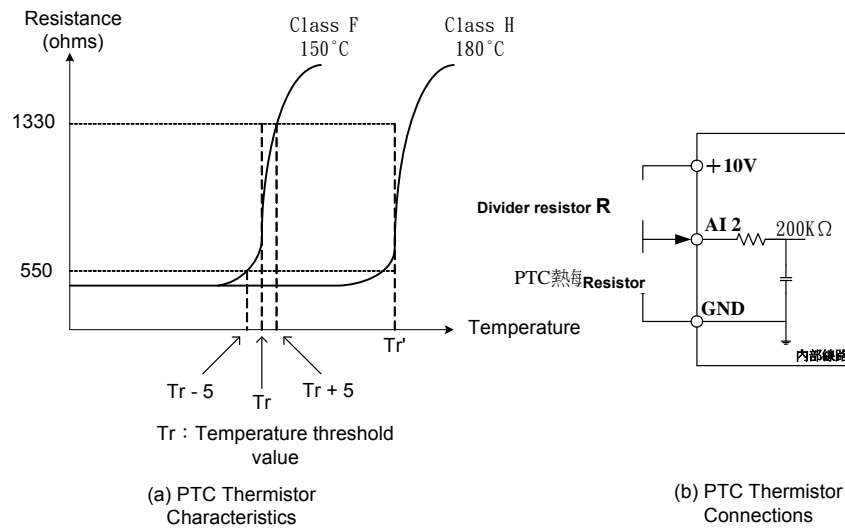

**Pic 4.3.65 (a) PTC Thermistor Characteristics (b) PTC Thermistor Connections**

<b>08-46</b>	<b>Temperature agree level</b>
<b>Range</b>	<b>【0 ~ 254】 °C</b>
<b>08-47</b>	<b>Temperature reset level</b>
<b>Range</b>	<b>【0 ~ 254】 °C</b>

Note: 08-47 maximum value will be limited by 08-46 set value

The inverter temperature agree and reset level selection

- **03-11** set to **【59】** :
- **08-46**: The inverter temperature is **> 08-46**, the relay operates.
- **08-47**: When the output current is **≤ 08-47**, the relay signal from **ON** to **OFF**.

Down time frequency diagram:

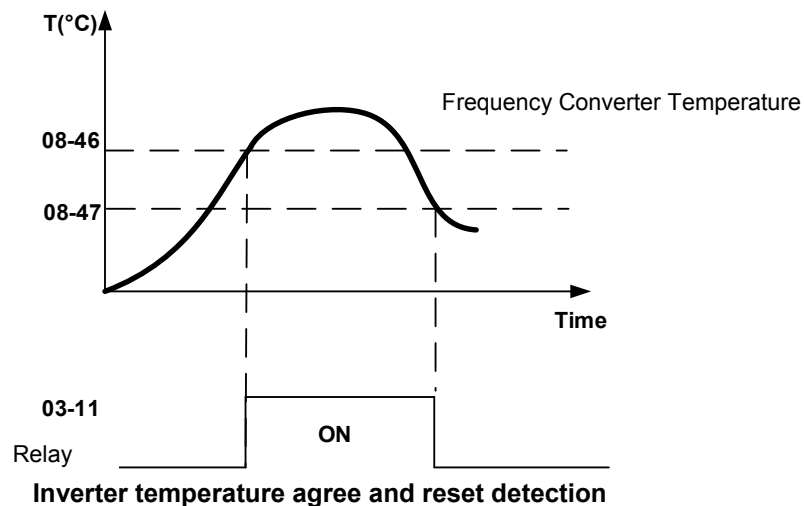

<b>08-48</b>	<b>Selection of Fire Mode</b>
<b>Range</b>	【0】 : Disable 【1】 : Enable
<b>08-49</b>	<b>Multi-Function Input Terminal Status of Fire Mode</b>
<b>Range</b>	【0】 : Reset after Power Off 【1】 : Reset after Terminal Removed
<b>08-50</b>	<b>Multi-Function Terminal Status of Fire Mode</b>
<b>Range</b>	【xxx0b】 : S6 A Contact 【xxx1b】 : S6 B Contact
<b>08-51</b>	<b>Motor Speed Setting Source of Fire Mode</b>
<b>Range</b>	【0】 : Fire Mode Speed (08-52) 【1】 : PID Control 【2】 : AI2
<b>08-52</b>	Fire Mode Motor Speed
<b>Range</b>	【0.00~100.00】 %
<b>08-59</b>	<b>Fire Mode Motor Direction</b>
<b>Range</b>	【0】 : Forward 【1】 : Reverse
<b>08-60</b>	<b>Fire Mode Password</b>
<b>Range</b>	【00000 ~ 65534】

- When 08-48=0, Fire Mode is disabled.  
When 08-48=1, Fire Mode is enabled.
- When fire mode is enabled, S6 will be defined to digital input of fire mode (03-0X=47).  
When fire mode is enabled, inverter will become to fire mode. No matter inverter is running or stopping, run and frequency command source will be covered by the setting of fire mode, keypad display will show “ FIRE ”, some of protect functions will be ignored, please refer the table 4.4.35, inverter will not stop.  
When fire mode (03-0X=47) and external overload (03-0X=69) function is triggered, the other digital inputs will be ignored, the parameters just can be read by communication or keypad display.
- When 08-49=0, please disconnect the power first, remove external trigger signal and then connect the power.
- When 08-49=1, no need to disconnect the power, inverter will become to normal mode, run and frequency will return to original setting.

Note: Only Version V1.30 and above will meet the above functions.

Table 4.4.35 These functions will be ignored when fire mode is triggered

0x2521H	Fault Description
4	OH1 (Heat sink over heat)
5	OL1 (Motor overload)
6	OL2 (Inverter overload)
7	OT (Over torque)
25	FB (PID feedback signal error)
26	Keypad Removed
28	CE (Communication error)
46	OH4 (Motor over heat)
49	MtrSw (DI Motor Switch Fault)
58	PF(Protection error)

**! Danger :**

Fire mode:

The drive will run at full speed either in forward or reverse direction and ignore all software protections until any one of the hardware protection is triggered or drive is damaged to achieve the requirement of smoke extraction and reduce the hazard to humans.

➤ Each bit of 08-50 presents an input:

08-50= 0 0 0 0 0 : Normal open  
           s6 1 : Normal close

Notes:

Please set 08-48=0 (fire mode disabled) before setting normal open or normal close contact.

Failure to comply may cause death or serious injury.

- When 08-51=0, motor speed setting will follow 08-52. If the value of 08-52 is 100%, inverter output frequency will follow the value of 01-02.
- When 08-51=1, motor speed setting will follow PID control; when fire mode is enabled, PID control will base on 10-47/10-48/10-49 (please refer the setting value of group 10)
- When 08-51=2, frequency reference will become to 4-20mA (default setting of 04-00)

**08-59: Fire Mode Motor Direction**

- When fire mode is enabled, motor direction will base on the setting of 08-59.

**08-60: Fire Mode Password**

- When fire mode is enabled, use can set password in parameter 08-60, please refer the process of parameter 13-07.
- In order to prevent the parameters of fire mode being modified, keypad display will just show the related parameters of fire mode when fire mode is enabled. (Parameter 08-48~08-60 will be read only).
- Parameter 08-60(password of fire mode) and 13-07(parameter password), only one parameter can be allowed to set at the same time.

<b>08-53</b>	<b>PID Detection Level of Fire Mode</b>
<b>Range</b>	<b>【0~100】 %</b>
<b>08-54</b>	<b>Delay Time of Fire Mode PID Loss</b>

<b>Range</b>	<b>【0.0~10.0】 Sec</b>
<b>08-55</b>	<b>PID Feedback Loss Detection Selection of Fire Mode</b>
<b>Range</b>	<b>【0】 : Keep Running</b> <b>【1】 : Fire Mode Speed(08-52)</b> <b>【2】 : Max. Output Frequency of Motor 1 (01-02)</b>

- When 08-51=1, PID feedback loss detection function will be opened automatically.
- When fire mode is enabled, if 08-51=1 and then PID feedback, inverter will be stopped after the setting value of 08-54.

**08-55: PID Feedback Loss Detection Selection of Fire Mode**

- When 08-55=0, output frequency will be fixed on current frequency.
- When 08-55=1, output frequency will be based on the setting value of parameter 08-52.
- When 08-55=2, output frequency will be based on the setting value of parameter 01-02.

When PID feedback value less than 08-53 and then longer than 08-54, inverter will keep running, but the frequency reference will be switched to 08-55, output frequency will not less than the setting value of 08-52.

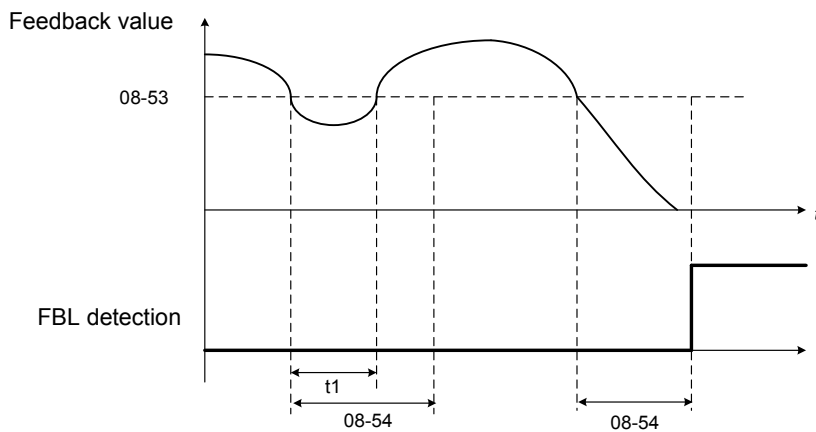

PID feedback loss detection

Notes:

If there is no any feedback signal and then feedback loss level also be set to 0%, feedback loss detection function will not be triggered.

<b>08-56</b>	<b>Detection Level of Fire Mode AI2 Signal</b>
<b>Range</b>	<b>【0~100】 %</b>
<b>08-57</b>	<b>Delay Time of Fire Mode AI2 Signal Loss</b>
<b>Range</b>	<b>【0.0~10.0】 Sec</b>
<b>08-58</b>	<b>Selection of Fire Mode AI2 Signal Loss</b>
<b>Range</b>	<b>【0】 : Keep Running</b> <b>【1】 : Fire Mode Speed(08-52)</b> <b>【2】 : Max. Output Frequency of Motor 1 (01-02)</b>

- When 08-51=2 (AI2), inverter will trigger AI2 feedback loss detection function automatically.
- Selection of Fire Mode AI2 Signal Loss (08-58) :
- When 08-58=0, output frequency will be fixed on current frequency.
  - When 08-58=1, output frequency will be based on the setting value of parameter 08-52.



➤ When 08-58=2, output frequency will be based on the setting value of parameter 01-02.

If AI2 signal is less than the setting value of 08-56 in 360ms, and the time longer than setting value of 08-57, the frequency reference will be considered to loss.

Analog signal will compare with the previous value at 360ms, if inverter ensure the frequency reference already loss, frequency reference will base on the value of 08-58.

Following is the description of the Frequency Loss Function:

When the inverter is in operation and the selected analog command source AI2 disappears, the command will operate according to the setting ratio of 08-58.

The following figure is the operating diagram of analog frequency instruction AI2 when the frequency Instruction is lost.

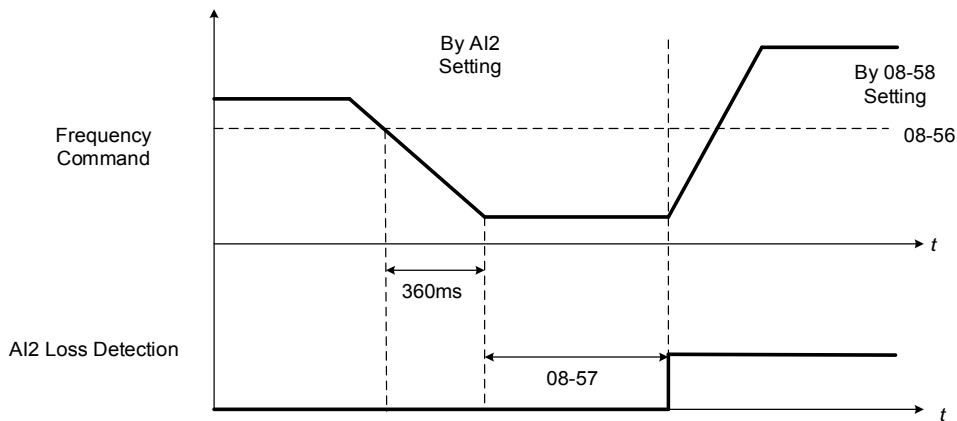

**Fig 4.3.77 AI2 frequency reference loss**

### 09-Communication Parameters

<b>09-00</b>	<b>INV Communication Station Address</b>
<b>Range</b>	1~31
<b>09-02</b>	<b>Baud rate setting (bps)</b>
<b>Range</b>	<b>0:</b> 1200 <b>1:</b> 2400 <b>2:</b> 4800 <b>3:</b> 9600 <b>4:</b> 19200 <b>5:</b> 38400
<b>09-03</b>	<b>Stop bit selection</b>
<b>Range</b>	<b>0:</b> 1 stop bit <b>1:</b> 2 stop bits
<b>09-04</b>	<b>Parity selection</b>
<b>Range</b>	<b>0:</b> No Parity <b>1:</b> Even bit <b>2:</b> Odd bit
<b>09-05</b>	<b>Communication Data Bit Selection</b>
<b>Range</b>	<b>0:</b> 8 Bit Data <b>1:</b> 7 Bit Data
<b>09-06</b>	<b>Communication error detection time</b>
<b>Range</b>	0.0~25.5 Sec
<b>09-07</b>	<b>Fault stop selection</b>
<b>Range</b>	<b>0:</b> Deceleration to stop based on deceleration time 1. <b>1:</b> Coast to stop when communication fault occurs. <b>2:</b> Deceleration to stop based on deceleration time 2 <b>3:</b> Keep operating when communication fault occurs.
<b>09-08</b>	<b>Comm. fault tolerance count</b>
<b>Range</b>	1~20
<b>09-09</b>	<b>Waiting time</b>
<b>Range</b>	5~65 msec

The Modbus communication port RJ45 (S+, S-) can be used to monitor, control, program and trouble-shoot the inverter.

Modbus communication can perform the following operations, independent of the frequency command selection (00-05) setting and Operation command selection (00-02) setting:

- Monitor inverter signals
- Read and write parameters.
- Reset fault
- Control multi-function inputs

### Modbus (RS-485) communication specification:

Items	Specification
Interface	RS-485
Communication type	Asynchronous (start - stop synchronization)
Communication parameters	Baud rate: 1200, 2400, 4800, 9600, 19200 and 38400 bps Data Length: 8 bits (Fixed) Parity: options of none, even and odd bit. For even and odd selection stop bit is fixed at 1 bit.
Communication protocol	Modbus RTU / ASCII
Number of inverters	Maximum 31 units

### Communication wiring and setup

- (1) Turn off power to the inverter.
- (2) Connect communication lines of the controller to the inverter (RJ45).
- (3) Turn power on.
- (4) Set the required communication parameters (09-00) via the keypad.
- (5) Turn off power to the inverter and wait until keypad is completely off.
- (6) Turn power on
- (7) Start communication between controller and inverter.

### Modbus (485) communication architecture

- (1) Modbus communication configuration uses a master controller (PC, PLC), communicating to a maximum of 31 inverters.
- (2) The master controller is directly connected to the inverter via the RS-485 interface. If the master controller has a RS-232, a converter must be installed to convert signals to RS-485 to connect the master controller to the inverter.
- (3) A maximum 31 inverters can be connected to a network, following the Modbus communication standard.

### Communication Parameters:

**09-00:** Inverter station addresses: Range 1-31

**09-02:** RS-485 communication baud rate setting

- = 0: 1200 bps (bits / second)
- = 1: 2400 bps
- = 2: 4800 bps
- = 3: 9600 bps
- = 4: 19200 bps
- = 5: 38400 bps

**09-03:** Stop bit selection

- = 0: 1 stop bit
- = 1: 2 stop bits

**09-04:** Parity selection of RS-485 communication

- = 0: No parity.
- = 1: even parity.
- = 2: odd parity.

**09-05:** Communication Data Bit Selection

- = 0: 8 bits data
- = 1: 7 bits data

**09-06:** RS-485 communication error detection time

**09-07:** Stop selection of RS-485 communication failure

- = 1: Deceleration to stop by deceleration time 00-15
- = 2: Coast to stop
- = 2: Deceleration to stop using the deceleration time of 00-26 (emergency stop time)
- = 3: Continue to operate (only shows a warning message, press the stop button to stop operation)

**09-08:** Comm. fault tolerance count

When the number of communication errors exceeds the value set in parameter 09-08 the inverter will display the comm. Fault alarm.

**09-09:** Wait time of inverter transmission (09-09).

Set the inverter response delay time. This is the time between the controller message and the start of the inverter response message. Refer to figure 4.4.78. Set the controller receive time-out to a greater value than the wait time parameter (09-09).

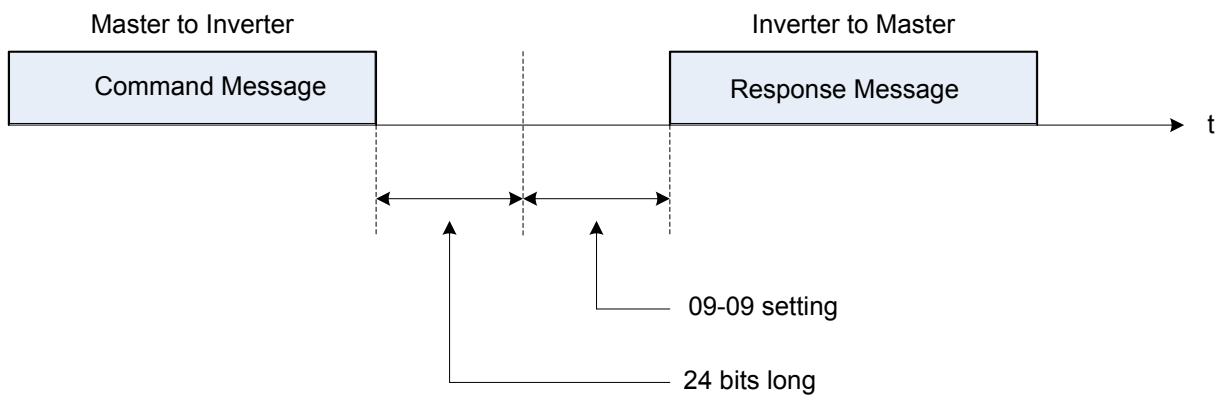

**Figure 4.4.78 Communication Message Timing**

## 10-PID Parameters

10-00	PID target value source setting
<b>Range</b>	<b>1:</b> AI1 given <b>2:</b> AI2 given <b>3:</b> Pulse given <b>4:</b> Use 10-02 setting <b>5:</b> Reserved <b>6:</b> Frequency Command (00-05)

### When 10-00=1 or 2,

Source of signal is proportional to be corresponding to PID target via analog input terminal.

For example:

0~10V is corresponding to 0~100% target value. When being given 2V, 20% target value is obtained.

### When 10-00=3,

PID target value is pulse input. The proportion of pulse input is set depending on the parameters of 03-30 (pulse input scales) ~ 03-34 (pulse input filter time).

For general purpose of PID setting, set 10-00=4 to set the PID target value.

### When 10-00=4

10-02(PID target value) is set at percentage and PID setting is at main screen monitor (12-38).

Maximum target value is set by parameter 10-33 (PID feedback maximum value), the decimals is determined by parameter 10-34 (PID decimal width), and the unit is set by parameter 10-35 (PID unit).

Ex:

Set 10-33 = 999, 10-34 = 1, 10-35 = 3, and set 10-02 to 10%

Then 9.9PSI is displayed at the main screen monitor (12-38) and can be modified at this monitor. Maximum value is 99.9 PSI (limited to the setting value of parameter 10-33).

### When 10-00=6

The current frequency command is proportional to be corresponding to PID target.

10-01	PID feedback value source setting
<b>Range</b>	<b>1:</b> AI1 given <b>2:</b> AI2 given <b>3:</b> PI given

**Note:** Parameter 10-00 and 10-01 cannot be set to the same source. If both parameters are set to the same source the keypad will show a SE05 alarm.

<b>10-02</b>	<b>PID target value</b>
<b>Range</b>	0.00~100.00 %

<b>10-03</b>	<b>PID control mode</b>
<b>Range</b>	<b>xxx0b</b> : PID disable <b>xxx1b</b> : PID enable <b>xx0xb</b> : PID positive characteristic <b>xx1xb</b> : PID negative characteristic <b>x0xxb</b> : PID error value of D control <b>x1xxb</b> : PID feedback value of D control <b>0xxxb</b> : PID output <b>1xxxb</b> : PID output + Frequency Command

PID target value source setting(10-00) / PID feedback value source setting(10-01)

Please confirm parameter 04-00 conform the need (0V~10 V or 4mA~20 mA) if AI2 as PID target or PID feedback. And switch SW2 (for standard H & C type) or SW4 (for enhanced E & G type) from control board to the input type (V or I), please refer to wiring diagram for more detail.

**When 10-03= xxx1b**: PID is enabled, LCD keypad will be switched automatically (16-00) and main screen monitoring displays PID target value (12-38). Sub-screen monitoring 1 (16-01) displays PID feedback value (12-39) and sub-screen monitoring 2 (16-02) displays frequency output (12-17). If PID is disabled, the keypad will switch automatically to frequency command setting as the main page.

**When 10-03= xx1xb**: PID output is reverse. PID output is chosen to reverse, and if PID input is negative, the output frequency of PID will gain. On the contrary, PID output is chosen to forward, and if PID input is minus, the output frequency of PID will decrease.

Refer to Fig. 4.4.78 & 4.4.79 when **10-03= x1xxb**: feedback value differential of PID control and **10-03= x0xxb**: basic PID control

**When 10-03= 0xxxb**: PID output, it corresponds 100% to the frequency of 01-02. **When 10-03= 1xxxb**: PID output + frequency command, it will cumulate the output percentage of frequency command, (corresponding to 01-02 main frequency command set by parameter 00-05/ 00-06) at the beginning of running and then start PID control.

<b>10-04</b>	<b>Feedback gain</b>
<b>Range</b>	0.01~10.00

<b>10-05</b>	<b>Proportional gain (P)</b>
<b>Range</b>	0.00~10.00

<b>10-06</b>	<b>Integral time (I)</b>
<b>Range</b>	0.0~100.0 Sec

<b>10-07</b>	<b>Differential time (D)</b>
<b>Range</b>	0.00~10.00 Sec

<b>10-09</b>	<b>PID bias</b>
<b>Range</b>	-100~100 %

<b>10-10</b>	<b>PID Primary delay time</b>
<b>Range</b>	0.00~10.00 %

<b>10-14</b>	<b>PID integral limit</b>
<b>Range</b>	0.0~100.0 %

<b>10-23</b>	<b>PID limit</b>
<b>Range</b>	0.00~100.0 %

<b>10-24</b>	<b>PID output gain</b>
<b>Range</b>	0.0~25.0

<b>10-25</b>	<b>PID reversal output selection</b>
<b>Range</b>	0: Do not allow the reversal output 1: Allow the reversal output

<b>10-26</b>	<b>PID target acceleration / deceleration time</b>
<b>Range</b>	0.0~25.5 Sec

### PID Adjustments

**Gain control:** The error signal (deviation) between the input command (set value) and the actual control value (feedback). This error signal or deviation is amplified by the proportional gain (P) to control the offset between the set value and the feedback value.

**Integral control:** The output of this control is the integral of the error signal (difference between set value and feedback value) and is used to minimize the offset signal that is left over from the gain control. When the integral time (I) is increased, the system response becomes slower.

**Differential control:** This control is the inverse from integral control and tries to guess the behavior of the error signal by multiplying the error with the differential time. The result is added to the PID input. Differential control slows down the PID controller response and may reduce system oscillation.

**Note:** Most applications that PID control (fan and pump) do not require differential control. Refer to Figure 4.4.79 for PID control operation

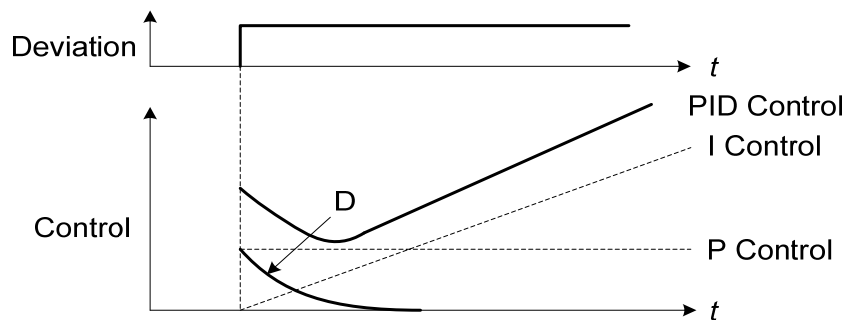

Figure 4.4.79 PID Control

## PID Control Type

The inverter offers two types of PID control:

### (a) PID control with differential feedback: (10-03 = x1xxb)

Make sure to adjust the PID parameters without causing system instability. Refer to Figure 4.4.80 for PID control for feedback value differential.

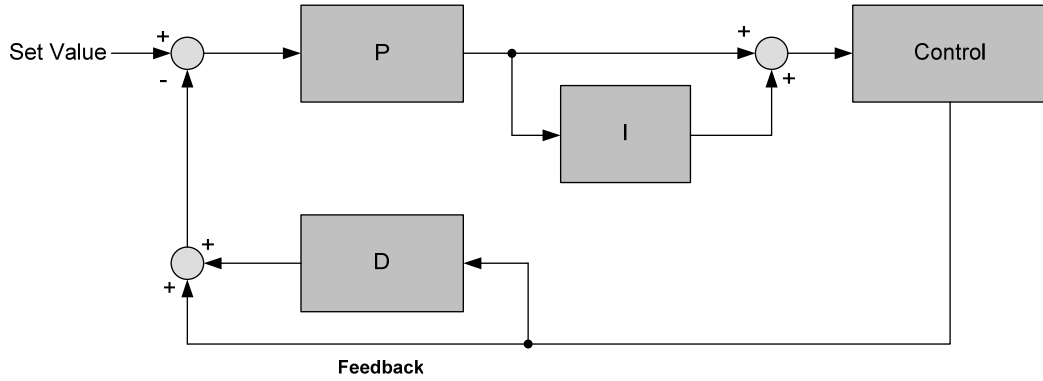

Figure 4.4.80 PID control for feedback differential value

### (b) Basic PID control: (10-03 = x0xxb)

This is the basic type of PID control. Refer to the figure 4.4.81.

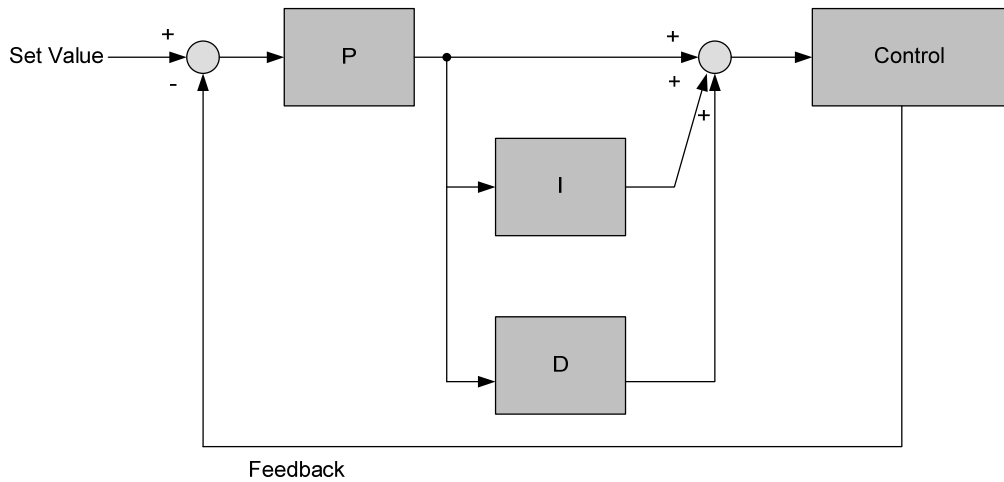

Figure 4.4.81 Basic PID control

## PID Setup

Enable PID control by setting parameter 10-03, PID target value (10-00) and PID feedback value (10-01).



(1) Select PID target value (10-00):

**10-00: PID target value**

- =1: analog AI1 given (default)
- =2: analog AI2 given
- =3: Pulse given
- =4: 10-02
- =6 frequency command (00-05)

(2) Select PID feedback value (10-01):

**10-01: PID feedback value**

- =1: Analog AI1 given
- =2: Analog AI2 given
- =3: Pulse given

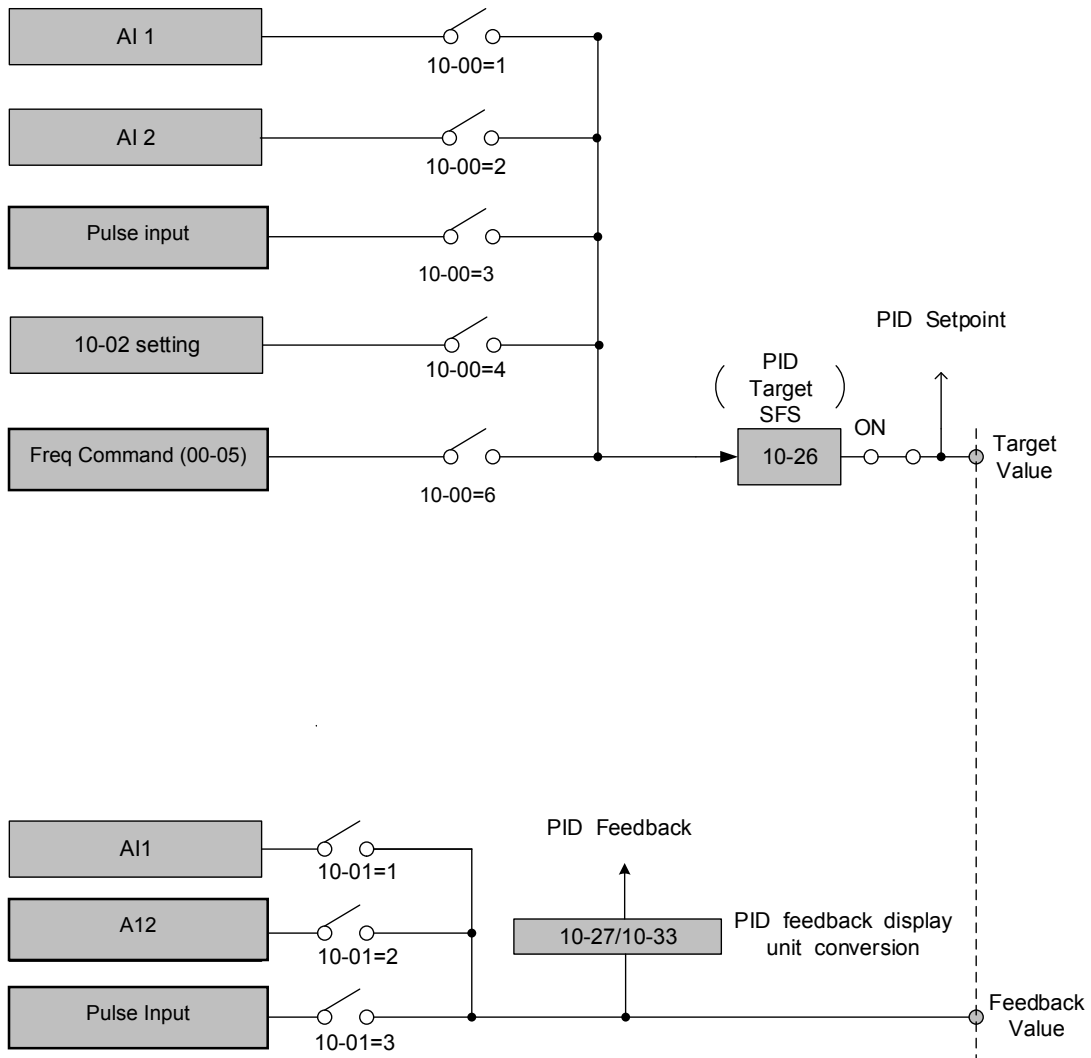

**Figure 4.4.82 PID input selection**

## PID Control Setting

PID control block diagram.

The following figure shows the PID control block diagram.

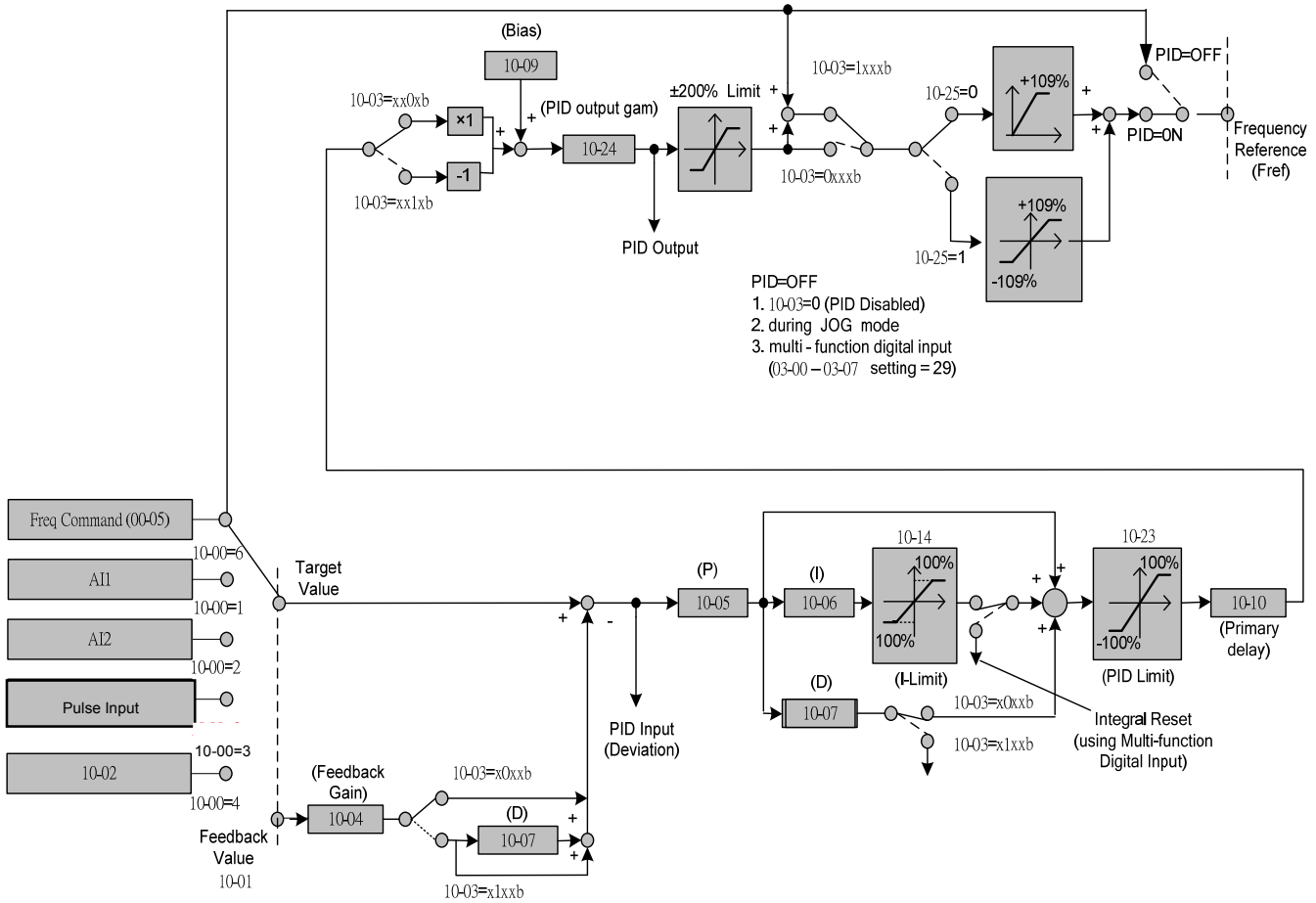

Figure 4.4.83 PID control block diagram

## PID Tuning

Use the following procedures to start PID control,

- (1) Enable PID control (set 10-03 to a value greater than "xx0b").
- (2) Increase the proportional gain (10-05) to the highest value possible without causing the system to become unstable.
- (3) Decrease the integral time (10-06) to the lowest value possible without causing the system to become unstable.
- (4) Increase the differential time (10-07) to the highest value possible without causing the system to become unstable.

The PID control serves to maintain a given process within certain limits whether it is pressure, flow etc. To do this the **feedback** signal is compared to the **set value** and the difference becomes the error signal for the PID control.

The PID control then responds by trying to minimize this error. The error is multiplied times the value of the **Proportional gain** set by parameter **10-05**. An increased gain value results in a larger error. However, in any system as the gain is increased there is a point that the system will become unstable (oscillate).

To correct this instability, the response time of the system may be **slowed** down by increasing the **Integral time** set by parameter **10-06**. However slowing the system down too much may be unsatisfactory for the process.

The end result is that these two parameters in conjunction with the acceleration time (01-14) and deceleration (**01-15**) times require to be adjusted to achieve optimum performance for a particular application.

PID output polarity can be selected with parameter 10-03 (setting = xx0xb: PID output forward, setting = xx1xb: PID output reversal). When PID output is chosen to reverse, and if PID input is negative, the output frequency of PID will gain. On the contrary, PID output is chosen to forward, and if PID input is minus, the output frequency of PID will decrease.

PID feedback value can be adjusted using parameter 10-04 (PID feedback gain) as well as with the analog input gain and bias for terminal AI1 or AI2.

**10-14: PID integral limit:** Used to limit the integral output to prevent motor stall or damage to the system in case of a rapid change in the feedback signal. Reduce the value of 10-14 to increase the inverter response.

**10-23: PID limit:** Used to limit the output of the PID control. Maximum output frequency is 100%.

**10-10: Primary delay time:** Low pass filter situated after the PID limit block that can be used to prevent PID output resonance. Increase the time constant to a value greater than the resonance frequency cycle and reduce time constant to increase the inverter response.

**10-09: PID bias:** Used to adjust the offset of the PID control. The offset value is added to the frequency reference as compensation. Use parameter 10-24 (PID output gain) to control the amount of compensation.

In case the PID control output value goes negative, parameter 10-25 (PID reversal output selection) can be used to reverse the motor direction.

**Note:** The PID output remains at zero when reverse operation is disabled.

**10-26: PID target SFS:** Sets the PID target value acceleration and deceleration ramp time. The PID target SFS can be disabled by setting the multi-function digital inputs 03-00 ~ 03-07 to 36 (PID target SFS is off). Reduce the acceleration / deceleration time in case load resonance or system instability is encountered.

## PID Fine Tuning

All PID control parameters are related to each other and require to be adjusted to the appropriate values. Therefore, the procedure achieving the minimum steady-state is shown as following:

- (1) Increase or decrease the proportion (P) gain until the system is stable using the smallest possible control change.
- (2) The integral (I) reduces the system stability which is similar to increasing the gain. Adjust the integral time so that the highest possible proportional gain value can be used without affecting the system stability. An increase in the integral time reduces system response.
- (3) Adjust the differential time if necessary to reduce overshoot on startup. The acceleration / deceleration time can also be used for the same purpose.

Fine-tuning PID control parameters:

- (1) Reduce overshoot

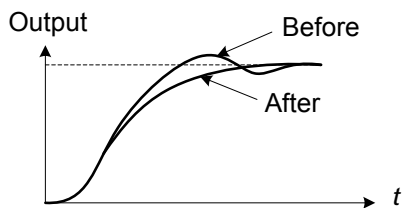

In case overshoot occurs, reduce the derivative time (D) and increase the integral time (I).

- (2) Stabilize PID control

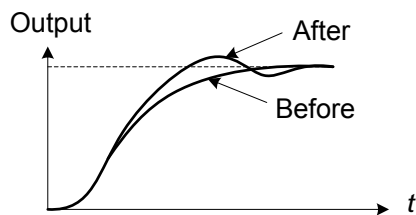

To quickly stabilize the PID control, reduce the integral time (I) and increase the differential time (D) in case overshoot occurs.

- (3) Reduce long-period oscillation

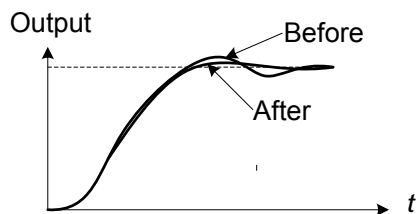

Adjust the integral time (I) in case of long-periodical system oscillation.

- (4) Reduce short-period oscillation

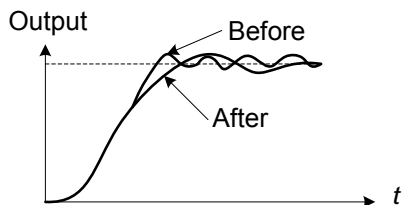

Adjusting the differential time (D) and proportional (P) gain when experiencing short-periodical oscillation.

<b>10-11</b>	<b>PID feedback loss detection selection</b>
<b>Range</b>	0: Disable 1: Warning 2: Fault
<b>10-12</b>	<b>PID feedback loss detection level</b>
<b>Range</b>	0~100 %
<b>10-13</b>	<b>PID feedback loss detection time</b>
<b>Range</b>	0.0~10.0 Sec

The PID control function provides closed-loop system control. In case PID feedback is lost, the inverter output frequency may be increase to the maximum output frequency.

It is recommended to enable to the PID feedback loss when the PID function is used.

### PID feedback loss detection

**10-11=0:** Disable

**10-11=1:** Warning

A feedback loss condition is detected when the PID feedback value falls below the value set in parameter 10-12 (PID feedback loss detection level) for the time set in parameter 10-13 (PID feedback loss detection time). PID feedback loss warning message "Pb" will be displayed on the keypad and the inverter will continue to operate.

**10-11=2:** Fault

A feedback loss condition is detected when the PID feedback value falls below the value set in parameter 10-12 (PID feedback loss detection level) for the time set in parameter 10-13 (PID feedback loss detection time). PID feedback loss fault message "Pb" will be displayed on the keypad, the inverter stops and the fault contact is activated.

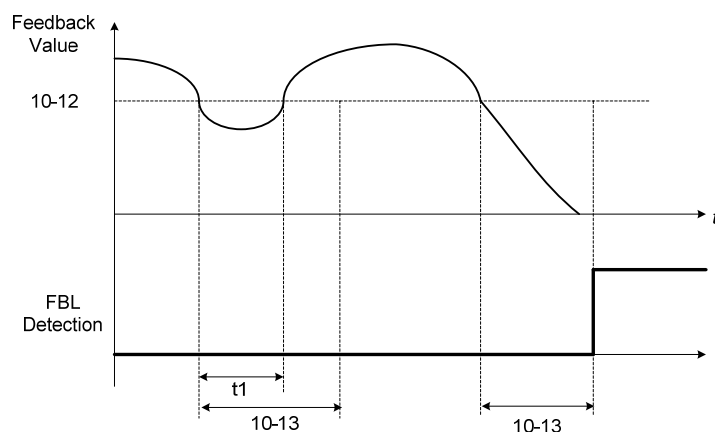

**Figure 4.4.84 PID feedback loss detection**

<b>10-17</b>	<b>Start frequency of PID sleep</b>
<b>Range</b>	0.00~599.00 Hz
<b>10-18</b>	<b>Delay time of PID sleep</b>
<b>Range</b>	0.0~255.5 Sec
<b>10-19</b>	<b>Frequency of PID wakeup</b>
<b>Range</b>	0.00~599.00 Hz
<b>10-20</b>	<b>Delay time of PID wakeup</b>
<b>Range</b>	0.0~255.5 Sec
<b>10-29</b>	<b>PID sleep selection</b>
<b>Range</b>	0: Disable 1: Enable 2: Set by DI
<b>10-40</b>	<b>Selection of PID Sleep Compensation Frequency</b>
<b>Range</b>	0: Disable 1: Enable

The PID Sleep function is used to stop the inverter when the PID output falls below the PID sleep level (10-17) for the time specified in the PID sleep delay time parameter (10-18).

The inverter wakes up from a sleep condition when the PID output (Reference frequency) rises above the PID wake-up frequency (10-19) for the time specified in the PID wake-up delay time (10-20).

Use parameter 10-29 to enable / disable PID sleep function.

**10-29 =0:** PID Sleep function is disabled.

**10-29 =1:** PID sleep operation is based on parameters of 10-17 and 10-18.

**10-29 =2:** PID sleep mode is enabled by multi-function digital input

Refer to figure 4.4.85 (a) and (b) for PID sleep / wakeup operation.

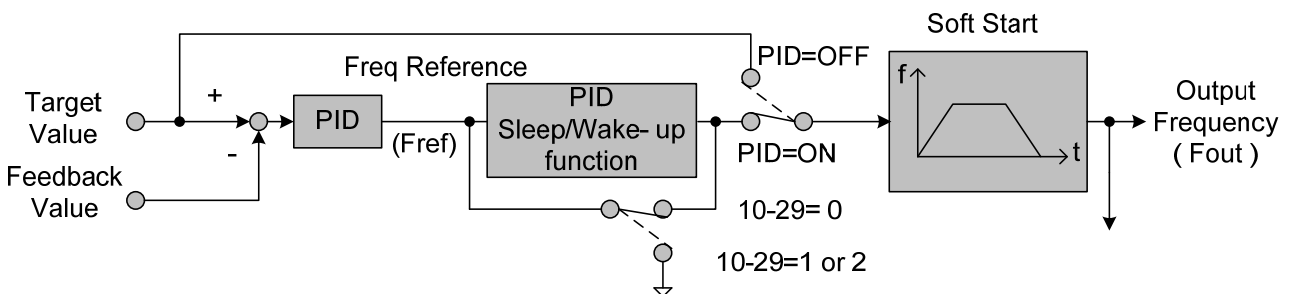

**Figure 4.4.85: (a) PID control block diagram**

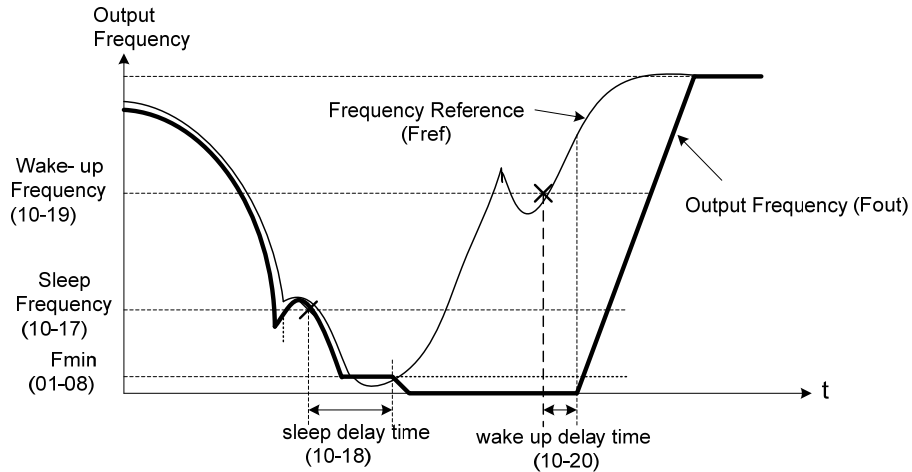

**Figure 4.4.85: (b) Timing diagram PID sleep / wakeup**

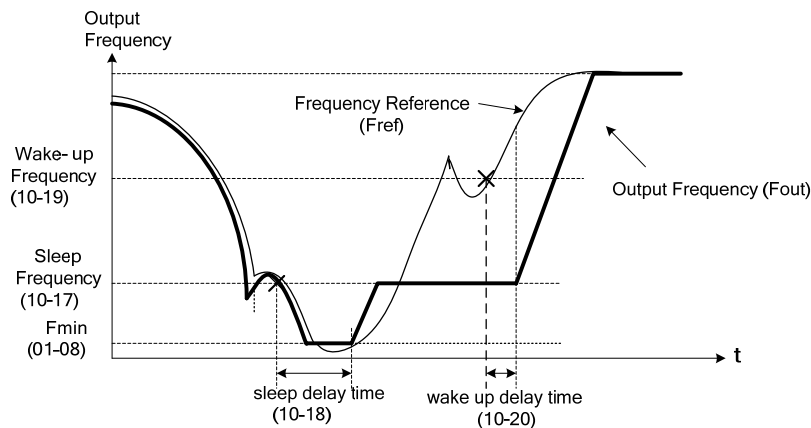

**Figure 4.4.85: (c) Timing diagram of PID sleep compensation frequency/ wakeup**

**Notes:**

**10-40=0, refer to Figure 4.4.85 (b)**

The PID sleep timer is enabled when the output frequency (Fout) falls below the PID sleep frequency (10-17). When the sleep timer reaches the set PID sleep delay time (10-18) the inverter will decelerate to a stop and enter the sleep mode.

**10-40=1, refer to Figure 4.4.85 (c)**

When output frequency (Fout) is lower than PID sleep frequency set by 10-17, Timer of PID sleep mode will run and the output frequency changes with the reference frequency (Fref) until it reaches the minimum output frequency (Fmin) set by 01-08. When the PID sleep delay time (10-18) is completed, the motor will run gradually to the PID sleep frequency set by 10-17.

**Note:** It should be used in the situation of being required the constant frequency.

While sleep mode is active and the motor has stopped, the internal PID control is still in operating. When the reference frequency increases and exceeds the wakeup frequency parameter 10-19 for the time specified in the wakeup delay time parameter 10-20, the inverter will restart and the output frequency will ramp up to the reference frequency.

**Example:**

-- When wakeup frequency < sleep frequency, inverter starts by the sleep frequency and sleeps depending on wakeup frequency.

-- When wakeup frequency > sleep frequency, inverter starts by the wakeup frequency and sleeps depending on sleep frequency.

Example: Sleep mode only have positive direction, if set 10-25 = 1 (Allow the reversal output), the sleep mode must be closed.

-- 10-00 and 10-01 can't set to the same source, if set the same values, the keypad will display " SE05 " PID selection error message.

-- When PID sleep selection is enabled or set by DI (10-29 = 1 or 2), and PID reversal output selection 10-25 = 1 (Allow the reversal output), the keypad will display " SE05 " PID selection error message.

-- When PID sleep selection is enabled or set by DI (10-29 = 1 or 2), and PID control mode 10-03 = 1xxx (PID output + Frequency Command, the keypad will display " SE05 " PID selection error message.

-- Use parameter 10-29 to enable or disable PID sleep function.

10-29 = 0: PID disable.

= 1: PID enable, operate by parameter 10-17 and 10-18.

= 2: PID set by DI.

<b>10-27</b>	<b>PID Feedback Display Bias</b>
<b>Range</b>	0~9999

**PID Feedback Display Scaling**

The PID feedback signal can be scaled to represent actual engineering units. Use parameter 10-33 to set the maximum value of PID feedback and parameter 10-27 to the feedback signal minimum.

**Example:**

Feedback signal is a pressure transducer (0-10V or 4-20mA ) with a range of 1.0 – 20.0 PSI  
 4mA (0V) = 1.0 PSI, 20mA (10V) = 20.0 PSI.

Set parameter 10-27 to 10 minimum of transducer range (0%).

Set parameter 10-33 to 200 maximum of transducer range (100%).

Refer to the figure 4.4.86 for displaying the unit conversion.

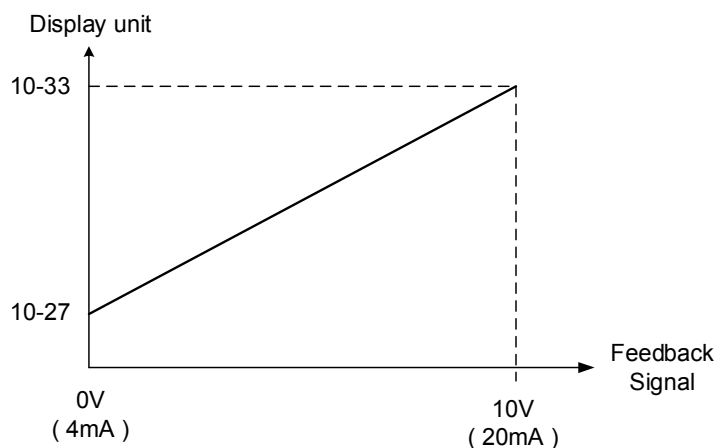

**Figure 4.4.86 Feedback signal scaling**



<b>10-30</b>	<b>Upper Limit of PID Target</b>
<b>Range</b>	0 ~ 100 %

<b>10-31</b>	<b>Lower Limit of PID Target</b>
<b>Range</b>	0 ~ 100 %

Target value of PID will be limited to the range of upper & lower limit of PID target.

<b>10-33</b>	<b>Maximum Value of PID Feedback</b>
<b>Range</b>	1~10000

When the maximum value of PID feedback is active, it will become 100% the corresponding value of 10-02.

<b>10-34</b>	<b>PID Decimal Width</b>
<b>Range</b>	0~4

PID decimal width is used for rounding up setting. For example: set 10-34=1, it displays XXX.X ; set 10-34=2, it displays XX.XX.

<b>10-35</b>	<b>PID Unit</b>
<b>Range</b>	0~24

PID unit is selected depending on user's needs.

Note: When user switches PID in LED keypad, 10-33 is required to be lower than 1000 and 10-34=1, or the keypad will show a SE05 alarm (PID setting error).

<b>10-39</b>	<b>Output Frequency Setting of PID Disconnection</b>
<b>Range</b>	00.00~599.00 Hz

When PID feedback disconnection is in alarm, frequency command output depends on the setting value of 10-39. If the warning is lifted, PID control is restored.

\* When the motor's maximum output frequency is over than 300Hz, the frequency resolution is 0.1Hz.

<b>10-08</b>	<b>A11 Frequency Limit</b>
<b>Range</b>	00.00~599.00 Hz
<b>10-15</b>	<b>PID Trim Mode</b>
<b>Range</b>	0~2
<b>10-16</b>	<b>PID Trim Scale</b>
<b>Range</b>	0~100

<b>10-41</b>	<b>PID Mode Switch</b>
<b>Range</b>	<b>【0】</b> : General PID <b>【1】</b> : D Type PID

Signal Given and Process:

When 10-41= 1 (D type PID), A510s can process the ratio conversion for external signal, and then the signal given value can correspond to the speed command.

The Signal given corresponds to the speed command mode:

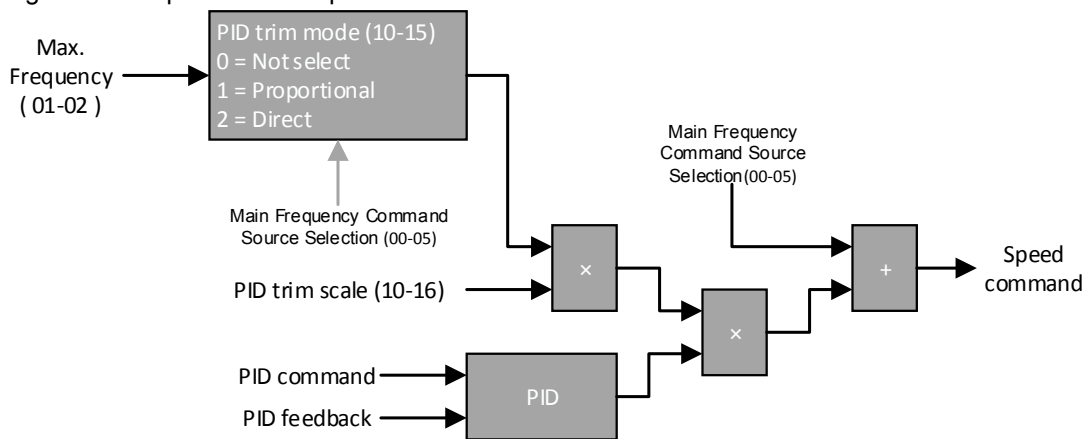

- Use the follow steps to start D type PID control:
  - (1) 10-03 (PID control mode) set to 1001b.
  - (2) 10-00 (PID target value source) set to 4 (10-02 given).
  - (3) 10-01 (PID feedback value source) set to 2 (AI2 given).
  - (4) 00-05 (Main frequency command source selection) set to 1 (External terminal: Analog 1).
  - (5) 10-29 PID sleep selection set to 0 (Disable).
- The maximum frequency limit is set by 10-08.
- 10-25 PID reversal output selection decide the output can or cannot reversal run.
- The first bit of 10-03 PID control mode decide to plus the frequency command.
- The response of PID control can be adjust 10-36 (Proportional gain 2), 10-37 (Integral Time 2) and 10-38 (Differential Time 2)
- 10-15 (PID trim mode) set to 1 (Proportional), use the multiple of 01-02 (Maximum output frequency of motor) and 01-12 (Base frequency of motor), then multiply the frequency of 00-05 (Main frequency command source selection), then multiply 10-16 (PID trim scale), the value can be used to modify the PID multiple.
- 10-15 (PID trim mode) set to 0 (Not select), use 01-02 (Maximum output frequency of motor) multiply 10-16 (PID trim scale), the value can be used to modify the PID multiple.

<b>10- 47</b>	<b>Proportioanl Gain 3 (P) of Fire Mode</b>
<b>Range</b>	<b>【 0.00~10.00 】</b>
<b>10- 48</b>	<b>Integral Time 3 (I) of Fire Mode</b>
<b>Range</b>	<b>【 0.0~100.0 】 Sec</b>
<b>10- 49</b>	<b>Differential Time 3 (D) of Fire Mode</b>
<b>Range</b>	<b>【 0.00~10.00 】 Sec</b>

➤ PID functions of ire mode, please refer to parameter group 08.

## 11-Auxiliary Parameters

11-00	Direction Lock Selection
<b>Range</b>	<b>0:</b> Allow forward and reverse rotation <b>1:</b> Only allow forward rotation <b>2:</b> Only allow reverse rotation

If motor operation direction is set to 1 or 2, the motor can only operate in that specific direction. Run commands in the opposite direction are not accepted.

Forward or reverse commands can be issued via the control terminals or keypad.

**Note:** The Direction Lock Selection can be used in fan and pump application where reverse rotation is prohibited.

11-01	Carrier frequency
<b>Range</b>	<b>【0】</b> : Carrier Output Frequency Tuning <b>【1~16】</b> : 1~16KHz

**Notes:**

- (1) Value 1 to 16 represents KHz.
- (2) When 11-01=0, the carrier frequency is modified by parameter 11-26~11-27 & 11-30~11-32.
- (3) For SLV and SV mode, the minimum value of 11-01 is 2 kHz, due to the sample rate, suggest to use 4 KHz, and the motor cable used within 100m.
- (4) Setting range is determined by the inverter rating (13-00) and HD/ND mode (00-27).
- (5) Refer to section 3 inverter derating based on carrier frequency.
- (6) A low carrier frequency increases motor noise but reduces motor losses and temperature.
- (7) A low carrier frequency decreases RFI, EMI interference and motor leakage current.

Refer to the carrier frequency Table 4.4.36.

**Table 4.4.36** Carrier frequency settings

Carrier Frequency	1KHz--6KHz	10KHz--16KHz
Motor noise	High -----	Low
Output current waveform (similar to sinusoidal wave)	Bad -----	Good ----- Bad
Noise interference	Low -----	High
Leakage current	Low -----	High
Heat loss	Low -----	High

If cable length between the inverter and the motor is too long, the high-frequency leakage current will cause an increase in inverter output current, which might affect peripheral devices. Adjust the carrier frequency to avoid this as shown in table 4.4.37.

**Table 4.4.37** Cable length and carrier frequency

Wire length	< 30 Meter (98ft)	up to 50 Meter (164 ft)	up to 100 Meter (328ft)	> 100 Meter* > 328ft
Carrier frequency (11-01 value)	Max. value 16KHz (11-01=16KHz)	Max. value 10KHz (11-01=10KHz)	Maxi. value 5KHz (11-01=5KHz)	Max. value 2KHz (11-01=2KHz)

**\*. If Cable is longer than 200m, the output dv/dt filter or output reactor is required.**

**Notes:**

- (1) Reduce the carrier frequency if the torque does not match the speed.
- (2) In V/F and V/F + PG control modes, set 11-01 to 0, the carrier frequency is determined by parameters 11-30 (Carrier frequency max. limit), 11-31 (Carrier frequency lower limit) and 11-32 (Carrier frequency proportional gain).

<b>11-02</b>	<b>Soft PWM Function Selection</b>
<b>Range</b>	<b>【0】</b> : Disable <b>【1】</b> : Soft PWM 1 enables <b>【2】</b> : Soft PWM 2 enables

**11-02=0:** Soft PWM control disables.

**11-02=1:** Soft PWM 1 control enables. Soft PWM control can improve the 'metal' noise produced by the motor, more comfortable for the human ear. At the same time, Soft PWM also limits RFI noise to a minimum level. The default setting of Soft PWM control is disabled. Soft PWM 1 cannot be set if carrier frequency set in 11-01 is higher than 8 kHz.

**11-02=2:** Soft PWM 2 control enables. User adjusts parameter 11-66 (2 Phase/3 Phase PWM Switch Frequency), 11-67 (Soft PWM 2 Frequency Range) and 11-68 (Soft PWM 2 Switch Frequency) by his/ her own feeling to noise.

<b>11-66</b>	<b>2 Phase/ 3 Phase PWM Switch Frequency</b>
<b>Range</b>	<b>【6.00~60.00】 Hz</b>

When the output frequency is higher than 11-66, the PWM mode will be switched.

<b>11-67</b>	<b>Soft PWM 2 Frequency Range</b>
<b>Range</b>	<b>【0~12000】</b>
<b>11-68</b>	<b>Soft PWM 2 Switch Frequency</b>
<b>Range</b>	<b>【6.00~60.00】</b>

When the output frequency is higher than 11-68, the noise detect function will be enabled, and according to 11-67 to modify the magnetic noise of motor.

**Note:**

- 1. When 11-02=2, estimator mode (22-26) and speed search mode selection (07-32) cannot be used at the same time.**
- 2. When 11-02=2, sum of 11-01 and 11-67 should be lower than the upper limit of carrier frequency. To avoid the error setting, please follow the rules listed as below.**

- If error occurs when setting 11-01, it means  $11-02=2$  and  $11-01 + 11-67 > \text{Upper limit of carrier frequency}$ , please reset 11-02 or 11-67.
- If error occurs when setting 11-67, it means  $11-02=2$  and  $11-01 + 11-67 > \text{Upper limit of carrier frequency}$ , please reset 11-02 or 11-01.
- When  $11-02=2$ , if error occurs when setting 11-01 or 11-67, it means  $11-01 + 11-67 > \text{Upper limit of carrier frequency}$ , please reset the parameter.
- If error occurs when setting  $11-02=2$ , it means  $11-01 + 11-67 > \text{Upper limit of carrier frequency}$ , please reset the parameter 11-01 or 11-67, then set  $11-02=2$ .

<b>11-03</b>	<b>Automatic carrier lowering selection</b>
<b>Range</b>	<b>0:</b> Disable <b>1:</b> Enable

If inverter detects the overheating, the carrier frequency will decrease automatically. Once this temperature returns to normal, the carrier frequency will automatically return to the set value of 11-01.

**11-03=0:** Automatic carrier frequency reduction during an overheat condition is disabled.  
Carrier frequency operation depends on the set value of 11-01.

**11-03=1:** Automatic carrier frequency reduction during an overheat condition is enabled.  
Carrier frequency automatically decreases to reduce the heat loss and avoid the inverter's trip so as to extend the period of use in inverter when the heat sink temperature is higher than the sett value.

<b>11-04</b>	<b>S curve time setting at the start of acceleration</b>
<b>11-05</b>	<b>S curve time setting at the end of acceleration</b>
<b>11-06</b>	<b>S curve time setting at the start of deceleration</b>
<b>11-07</b>	<b>S curve time setting at the end of deceleration</b>
<b>Range</b>	0.00~2.50 Sec

The S curve function for acceleration / deceleration is used to reduce mechanical impact caused by the load during momentary starting and stopping of the inverter. To use the S curve function set the time for acceleration start point (11-04), acceleration end point (11-05), deceleration start point (11-06) and deceleration end point (11-07). Refer to figure 4.4.87 for more information.

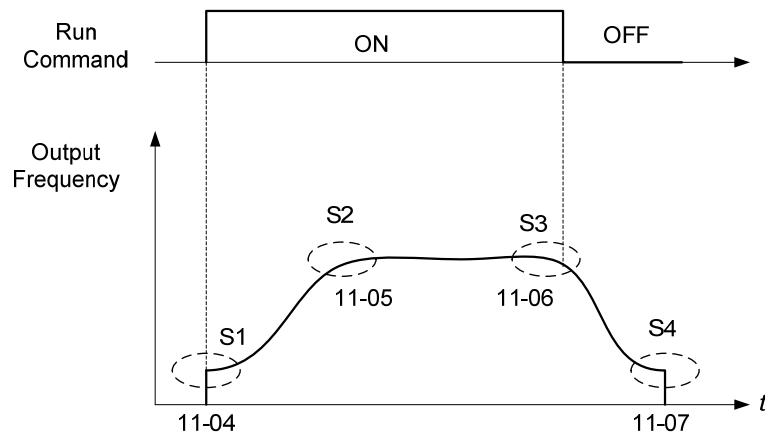

**Figure 4.4.87 S curve characteristic**

Total acceleration and deceleration time when the S curve is used:

$$\text{Accelerating time} = \text{Accelerating time 1 (or 2)} + \frac{(11-04) + (11-05)}{2}$$

$$\text{Deceleration time} = \text{Deceleration time 1 (or 2)} + \frac{(11-06) + (11-07)}{2}$$

<b>11-08</b>	<b>Jump frequency 1</b>
<b>11-09</b>	<b>Jump frequency 2</b>
<b>11-10</b>	<b>Jump frequency 3</b>
<b>Range</b>	0.0~599.0 Hz

<b>11-11</b>	<b>Jump frequency width</b>
<b>Range</b>	0.0~25.5 Hz

These parameters allow “jumping over” of certain frequencies that can cause unstable operation due to resonance within certain applications.

**Note:** Prohibit any operation within the jump frequency range. During acceleration and deceleration the frequency is continuous without skipping the jump frequency.

To enable jump frequency 1 – 3 (11-08 – 11-10) set the frequency to a value greater than 0.0 Hz.

Use the jump frequency width (11-11) to create a jump frequency range. Refer to figure 4.4.88.

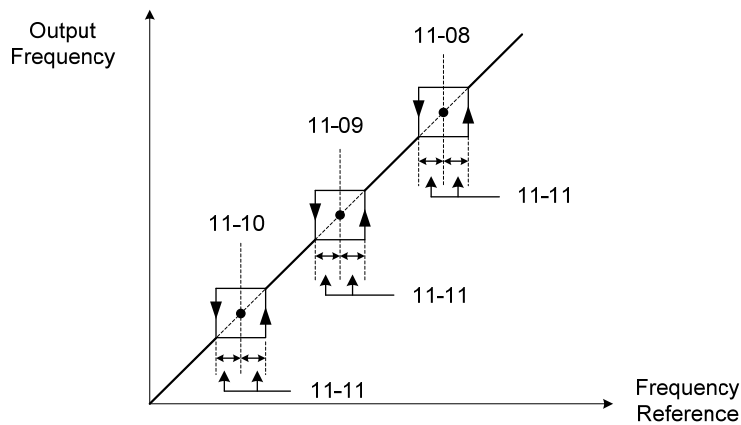
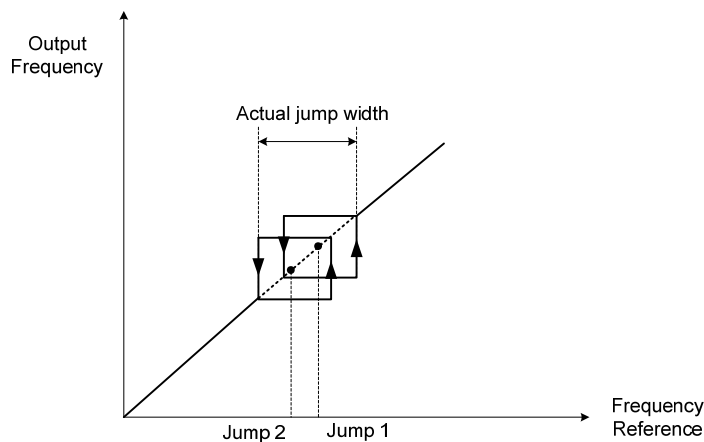

**Figure 4.4.88 Jump frequency operation**

#### Jump frequency via Analog Input.

Set parameter 04-05 (AI2 function selection) to 9 (frequency jump setting 4) to control the jump frequency via analog input AI2. Refer to Figure 4.4.48.

**Note:** When jump frequency overlap the sum of the overlapped jump frequencies will be used as the jump frequency range. Refer to figure 4.4.89.



**Figure 4.4.89 Jump frequency overlap**

<b>11-13</b>	<b>Automatic return time</b>
<b>Range</b>	0~120 sec

If the keypad is not pressed within the time specified in 16-06 (returning time of automatic back button), the keypad will automatically return to the mode screen.

When it is set to 0, the automatic return function is off. Press the back button to return to the previous directory.

<b>11-12</b>	<b>Manual energy saving gain</b>
<b>Range</b>	0~100 %

<b>11-18</b>	<b>Manual energy saving frequency</b>
<b>Range</b>	0.0~599.0 Hz

Manual energy savings reduces the output voltage for the purpose of saving energy.

To enable manual energy savings set one of the multi-function digital input (03-00 to 03-07) to 20 and activate the input or use parameter 11-18 to set the manual energy savings activation frequency.

When the output frequency rises above the value set in parameter 11-18 manual energy savings function is enabled. Setting parameter 11-18 manual energy savings frequency to 0.0 Hz disables the manual energy savings frequency activation function. Refer to figure 4.4.88 for more information.

**Note:** Only use manual energy savings functions in combination with light loads.

Manual energy saving gain (11-12) determines the output voltage of the inverter when manual energy savings is enabled. Output voltage is percentage gain times the V/F voltage.

Manual energy saving control uses the voltage recovery time (07-23) to change the output voltage

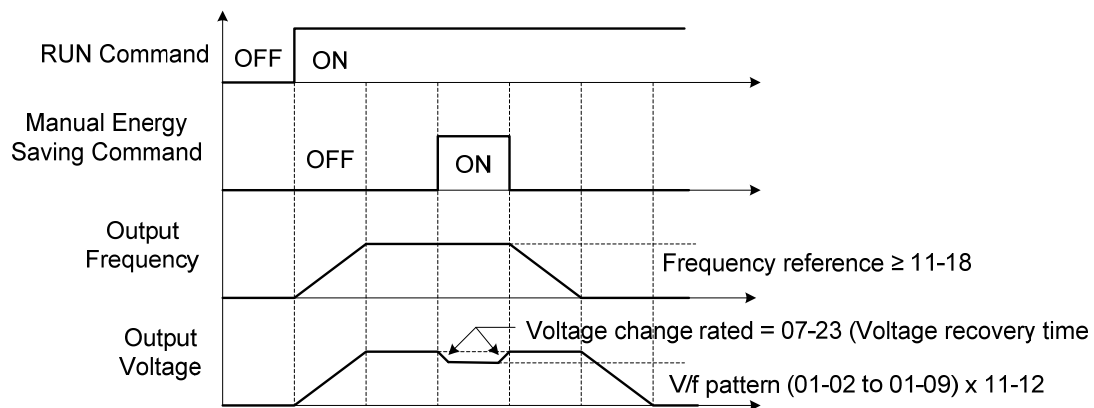

**Figure 4.4.90 Manual energy saving operation**

<b>11-19</b>	<b>Automatic energy saving function</b>
<b>Range</b>	0: Automatic energy saving is disabled 1: Automatic energy saving is enabled
<b>11-20</b>	<b>Filter time of automatic energy saving</b>
<b>Range</b>	0~200 msec
<b>11-21</b>	<b>Voltage upper limit of energy saving tuning</b>
<b>Range</b>	0~100%
<b>11-22</b>	<b>Adjustment time of automatic energy saving</b>
<b>Range</b>	0~5000 msec
<b>11-23</b>	<b>Detection level of automatic energy saving</b>
<b>Range</b>	0~100%
<b>11-24</b>	<b>Coefficient of automatic energy saving</b>
<b>Range</b>	0.00~655.34

In the V/F control mode the automatic energy saving (AES) function automatically adjusts the output voltage and reduces the output current of the inverter to optimize energy savings based on the load.

The output power changes proportional to the motor load. Energy savings is minimal when the load exceeds 70% of the output power and savings become greater when the load decreases.

The parameter of automatic energy saving function has been set at the factory before shipment. In general, it is no need to adjust. If the motor characteristic has significant difference from the TECO standard, please refer to the following commands for adjusting parameters:

#### **Enable Automatic Energy Savings Function**

- (1) To enable automatic energy saving function set 11-19 to 1.
- (2) Filter time of automatic energy saving (11-20)
- (3) Commissioning parameter of energy saving (11-21 to 11-22)

In AES mode, the optimum voltage value is calculated based on the load power requirement but is also affected by motor temperature and motor characteristic.

In certain applications the optimum AES voltage needs to be adjusted in order to achieve optimum energy savings. Use the following AES parameters for manual adjustment:

#### **11-21: Voltage limit value of AES commissioning operation**

Set the voltage upper limit during automatic energy saving. 100% corresponds to 230V or 460V or 575/690V depending on the inverter class used. Refer to the figure 4.4.91.



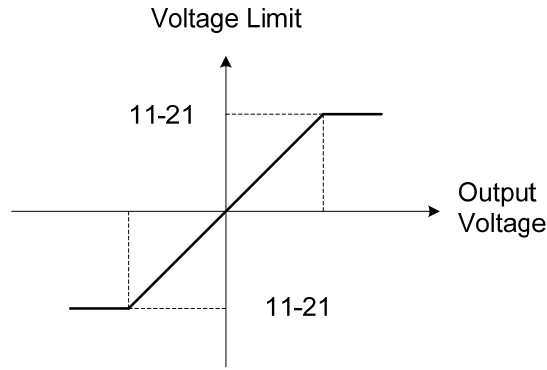

**Figure 4.4.91 Voltage limit value of commissioning operation**

**11-22:** Adjustment time of automatic energy saving

Sets sample time constant for measuring output power.

Reduce the value of 11-22 to increase response when the load changes.

**Note:** If the value of 11-22 is too low and the load is reduced the motor may become unstable.

**11-23:** Detection level of automatic energy saving

Set the automatic energy saving output power detection level.

**11-24:** Coefficient of automatic energy saving

The coefficient is used to tune the automatic energy saving. Adjust the coefficient while running the inverter on light load while monitoring the output power. A lower setting means lower output voltage.

**Notes:**

- If the coefficient is set to low the motor may stall.
- Coefficient default value is based on the inverter rating. Set parameter 13-00. If the motor power does not match the inverter rating.

<b>11-26</b>	<b>Carrier Output Frequency Tuning Upper Limit (%)</b>
<b>Range</b>	<b>10~100%</b>
<b>11-27</b>	<b>Carrier Output Frequency Tuning Lower Limit (%)</b>
<b>Range</b>	<b>2~100%</b>

If 11-01=0, when the carrier frequency is adjusted with the output frequency, in addition to the carrier frequency upper and lower limits for 11-30~32 to adjust with the frequency, the specific output frequency range can be adjusted through 11-26~27, and the carrier frequency can be adjusted with the output frequency; if the limit is exceeded, no carrier frequency adjustment is performed.

<b>11-29</b>	<b>Auto De-rating Selection</b>
<b>Range</b>	<b>0: Disable 1: Enable</b>

The automatic de-rating function automatically reduces the output frequency by 30% of the nominal motor speed when the inverter detects an overheat condition (heatsink).

Automatic de-rating function depends on the automatic carrier frequency reduction selection (11-03).

If automatic carrier frequency reduction is disabled (11-03=0), the output frequency is reduced by 30% of the nominal motor speed when an overheat condition is detected.

If automatic carrier frequency reduction is enabled (11-03=1), the output frequency is reduced by 30% of the nominal motor speed when the carrier frequency is at its minimum setting.

**11-29=0:** Auto de-rating selection disabled, carrier frequency is based on 11-01 or 11-03.

**11-29=1:** Auto de-rating selection is enabled.

<b>11-30</b>	<b>Variable Carrier Frequency Upper Limit</b>
<b>Range</b>	2~16 KHz

<b>11-31</b>	<b>Variable Carrier Frequency Lower Limit</b>
<b>Range</b>	1~16 KHz

<b>11-32</b>	<b>Variable Carrier Frequency Proportional Gain</b>
<b>Range</b>	00~99

Carrier frequency method depends on the selected control mode.

Control Mode	Variable Carrier Frequency (11-01 = 0)	Fixed Carrier Frequency (11-01 = 2-16 kHz)
V/F and V/F + PG	Available	Available
SLV and SV	Not available	Available

Variable carrier frequency can be adjust with parameter 11-30 ~ 11-32.

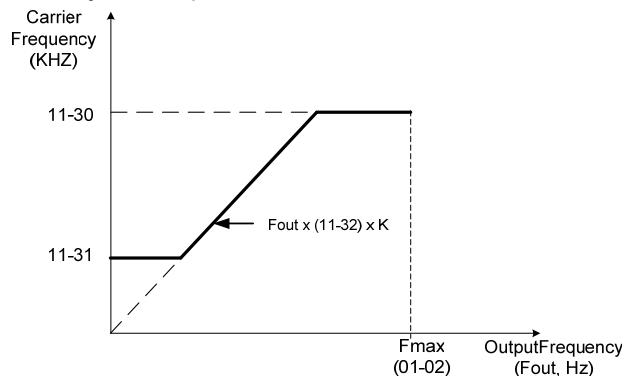

K is a coefficient; the value of K is based on the following based on the upper carrier frequency:

K=1: when 11-30 < 5 KHz

K=2: when 10 KHz > 11-30 ≥ 5 KHz

K=3: when 11-30 ≥ 10KHz

**Notes:**

- In V/F and V/F + PG control mode if the speed and torque are constant, the variable carrier frequency mode (11-01=0) can be selected to reduce the carrier frequency based on output frequency.
- If the carrier frequency proportional gain (11-32) > 6 and 11-30 < 11-31, error message "SE01" out of range will appear on the keypad.
- If the lower limit (11-31) is set higher than the upper limit (11-30), the lower limit will be ignored and the carrier frequency will be set at the upper limit (11-30).
- In fixed carrier frequency mode (11-01 = 2-16) parameters 11-30, 11-31 and 11-32 are not used.
- In SLV and SV control mode, the upper limit of the carrier frequency is fixed at 11-30.

<b>11-28</b>	<b>Frequency Gain of Over Voltage Prevention 2</b>
<b>Range</b>	1~200%
<b>11-33</b>	<b>DC Voltage Filter Rise Amount</b>
<b>Range</b>	0.1~10.0 V
<b>11-34</b>	<b>DC Voltage Filter Fall Amount</b>
<b>Range</b>	0.1~1.00 V
<b>11-35</b>	<b>DC Voltage Filter Deadband Level</b>
<b>Range</b>	0.0~99.0 V
<b>11-36</b>	<b>Frequency gain of OV prevention</b>
<b>Range</b>	0.000~1.000
<b>11-37</b>	<b>Frequency limit of OV prevention</b>
<b>Range</b>	0.00~599.00 Hz
<b>11-38</b>	<b>Deceleration start voltage of OV prevention</b>
<b>Range</b>	200V: 200~400 V : 400V: 400~800 V 575V: 500~1000V 690V: 600~1200V
<b>11-39</b>	<b>Deceleration end voltage of OV prevention</b>
<b>Range</b>	200V: 300~400 V 400V: 600~800 V 575V: 500~1000V 690V: 600~1200V
<b>11-40</b>	<b>OV prevention selection</b>
<b>Range</b>	<b>0:</b> Disable <b>1:</b> OV prevention Mode 1 <b>2:</b> OV prevention Mode 2 <b>3:</b> OV Prevention Mode 3

Overvoltage suppression is used for the application of likely causing to energy recharge.

Example: there are two situations causing excessive energy to recharge the inverter in stamping application

- (1) When cam clutch is not engaged, the motor will accelerate and start flywheel. When motor decelerates, the rotation speed will higher than motor speed owing to the large flywheel's inertia and then recharge the inverter.
- (2) When cam clutch is engaged, the motor will start flywheel and compress the spring. When the highest point of the cam moves beyond its center, the spring will release the power to the flywheel and excessive energy output recharge the inverter.

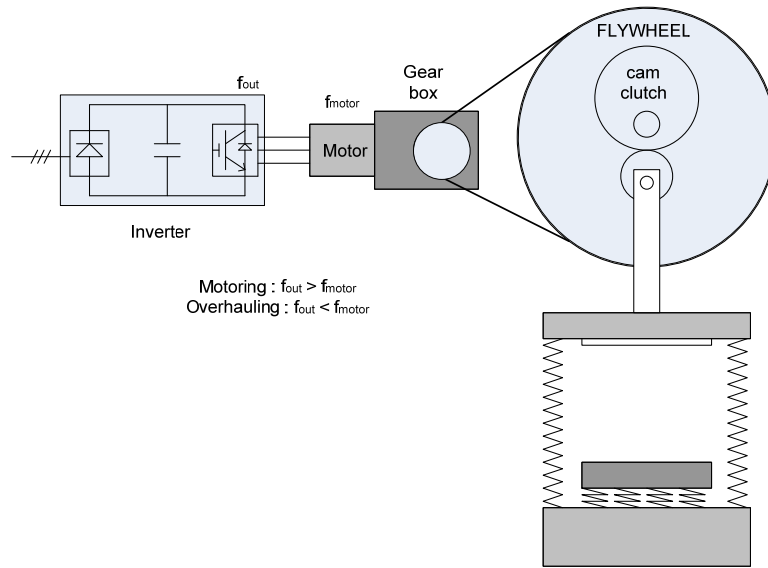

**Figure 4.4.92 Stamping Operation**

Over-voltage prevention (OVP) function monitors the DC-bus voltage and adjusts the speed reference, acceleration and deceleration rate, to prevent the inverter from tripping on an overvoltage.

When the speed reference is reduced, the motor will start to decelerate. When the inverter is operating at a fixed output frequency and excessive regenerative energy back to the inverter is detected the inverter will accelerate the motor in order to reduce the DC-bus voltage. Refer to figure 4.4.93.

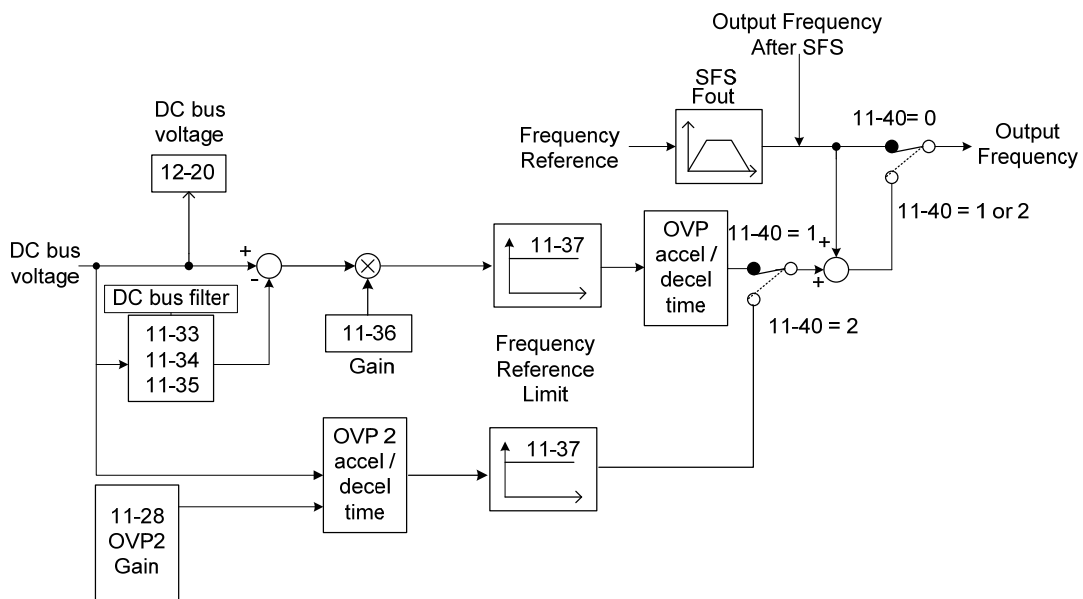

**Figure 4.4.93 OVP operation**

**When 11-40=1: OV prevention Mode 1**

1) DC voltage filter is used to provide a stable reference value for determining the change in DC voltage change during regenerative operation.

- Adjust the DC voltage filtering increase rate parameter 11-33 (DC Voltage Filter Rise Amount). When the DC voltage exceeds 11-33 +11-35 (DC Voltage Filter Deadband Level), the output of the filter will increase.
- Adjust the DC voltage filtering decrease rate parameter 11-34 (DC Voltage Filter Fall Amount). When the DC voltage exceeds 11-33 +11-35 (DC Voltage Filter Deadband Level), the output of the filter will decrease.
- Monitor the DC voltage filter output by 12-20 (DC voltage filter value).
- Set the DC voltage filter decrease rate (11-34) to a greater value than the value of the DC voltage filtering increase rate (11-33).

2) When the inverter is operation at a fixed output frequency, the OVP function will monitor the DC-bus voltage to detect regenerative operation.

In case of a regenerative condition the inverter calculates the delta DC bus voltage value and multiplies the value with parameter 11-36, the result is added to the frequency reference accelerating the motor to prevent on an overvoltage condition.

When the regenerative energy decreases, the inverter output frequency will return to the actual frequency reference. Deceleration rate is based on the DC voltage, as shown in Figure 4.4.94.

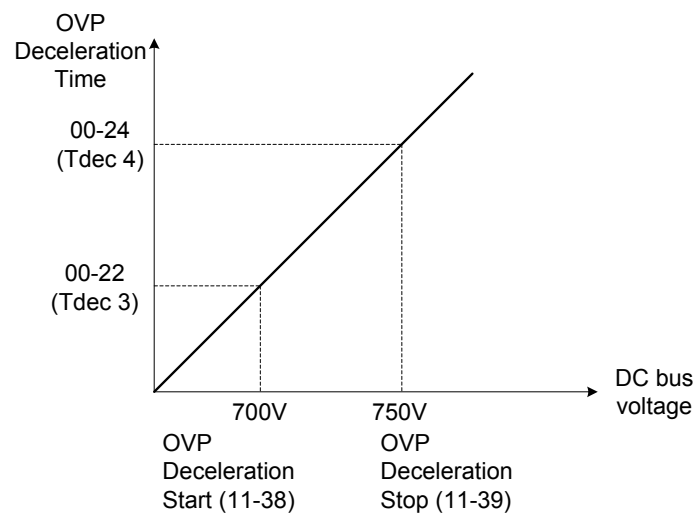

**Figure 4.4.94 OVP deceleration time**

3) When the inverter is stopped, the deceleration rate can be set with parameter 00-15 (Tdec1). In case the DC voltage is too high, the inverter will decelerate based on the OVP deceleration time as shown in Figure 4.4.93.

- Set DC-bus voltage in parameter 11-38 (start voltage of OVP deceleration) and set OVP deceleration rate in 00-22 (Tdec3).
- When the DC voltage reaches this level, it is necessary to decelerate rapidly in order to prevent the delta DC voltage of becoming too large.

- When DC voltage reaches the setting of 11-39 (stop voltage of OVP deceleration), it will decelerate based on the set value of 00-24 (Tdec4)
  - Deceleration rate is linear based on the slope defined by the start point (11-38) and end point (11-39).
- 4). Enable the OVP function with parameter 11-40 set to 1 or 2. The following parameter default values will be changed when the OVP function is enabled:

00-14(Tacc1)= 5.0 Sec(the frequency reference acceleration rate when DC voltage is too high.)  
 00-22(Tdec3)= 20.0 Sec(low setting point of OVP deceleration rate).  
 00-24(Tdec4)= 100.0 Sec(high setting point of OVP deceleration rate).

**Note:** S curve should be disabled when using the OVP function (11-04~11-07=0.0sec).

**When 11-40=2:** OV prevention Mode 2

The process of OV prevention mode 2 is the same as that of OV prevention mode 1 but it strengthens more the part of DC BUS over the deceleration stop voltage of OV prevention (11-39) in Fig.4.4.92. It can accelerate frequency compensation to avoid OV protection by increasing frequency gain of OV prevention 2 (11-28).

**When 11-40=3:** OV prevention Mode 3

T=The inverter raise the output frequency temporarily to avoid OV, the output frequency wont higher than the value of 01-02 (Maximum Output Frequency of Motor 1).Please adjust the value of 01-02 according to application. If it still occur OV in 11-40=3, please raise the value of 11-64 in 0.1 unit.

<b>11- 64</b>	<b>Acceleration Speed Gain Adjustment</b>
<b>Range</b>	0.1~10.0

<b>11- 65</b>	<b>Target Main Circuit Voltage</b>
<b>Range</b>	200V: 200V~400V 400V: 400V~800V 575V: 520V~1040V 690V: 624V~1248V

It will influence the speed and current if the value of 11-64 is too high.  
 11-65 is the target voltage of overvoltage prevention mode 3, and it is required to suppress this voltage level as much as possible.

<b>11- 41</b>	<b>Reference frequency loss detection</b>
<b>Range</b>	<b>0:</b> when reference frequency disappears, the deceleration will stop. <b>1:</b> when reference frequency disappears, continue to operate according to the proportion of reference frequency x 11-42.

<b>11- 42</b>	<b>Reference frequency loss level</b>
<b>Range</b>	0.0~100.0 %

A Reference frequency loss is detected when the frequency command falls 90% within 360ms.

The action performed when a reference loss is detected is set with parameter 11-41.

**11-41=0:** Inverter will decelerate to a stop when a reference loss is detected.

**11-41=1:** Inverter will continue to operate; reference frequency is the value of Maximum Output Frequency of Motor 1 x the level set in parameter 11-42.

The inverter will return to normal operation when:

- (1) The reference frequency is restored while running and the reference level exceeds 80% of the master frequency command.
- (2) Stop command is issued.

**Notes:**

- Reference frequency loss level (11-42) is corresponding to the maximum output frequency of Motor 1 (01-02).
- Reference frequency loss level is used in the analog signal (1: AI1 or 7: AI2) from the selection of main frequency source (00-05).

Refer to the following Fig. 4.4.95 for the operation diagram of multi-function digital output (03-11~03-12) when the analog frequency command is in the loss of frequency command.

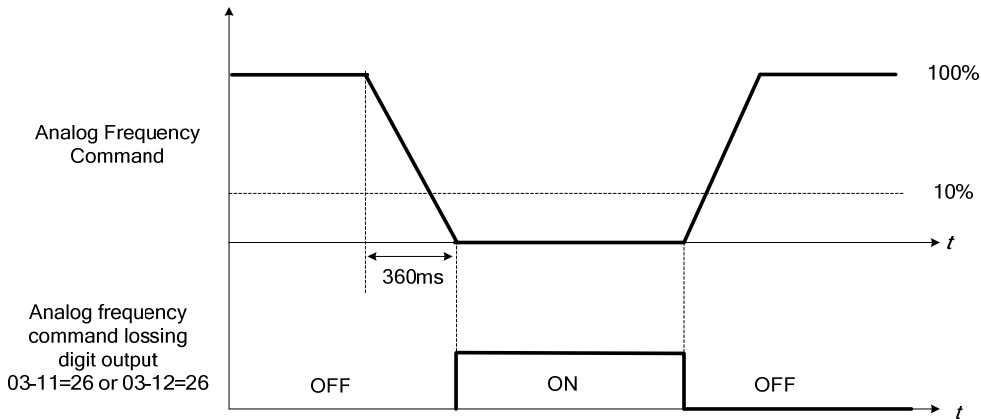

**Figure 4.4.95 Operation in reference frequency loss**

<b>11-43</b>	<b>Hold frequency at start</b>
<b>Range</b>	0.0~599.0 Hz
<b>11-44</b>	<b>Frequency hold time at start</b>
<b>Range</b>	0.0~10.0 Sec
<b>11-45</b>	<b>Hold frequency at stop</b>
<b>Range</b>	0.0~599.0 Hz
<b>11-46</b>	<b>Frequency hold time at stop</b>
<b>Range</b>	0.0~10.0 Sec

The hold function is used to temporarily hold the reference frequency in order to prevent stalling the motor or preventing an over current condition during starting or stopping due to load conditions.

During start the inverter will operate at the hold frequency at start for the time specified in the parameter 11-44 in order to establish the magnetic flux.

**Note:** The acceleration of deceleration time does not include the start and stop hold time. Refer to the figure 4.4.96.

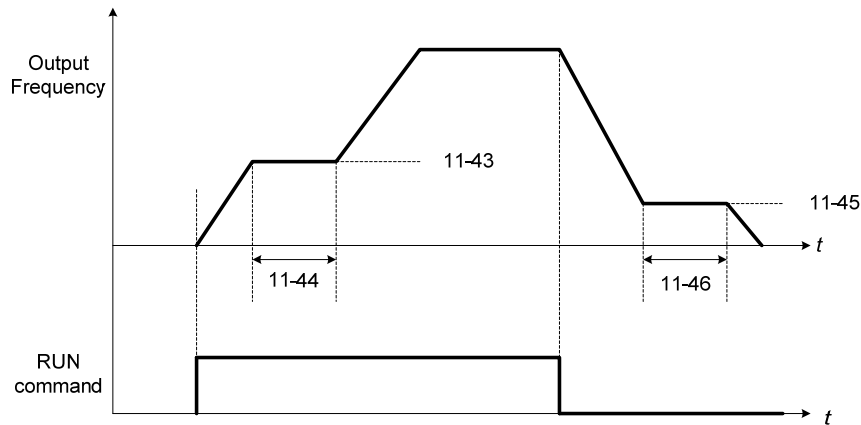

**Figure 4.4.96 Reserved function**

When the inverter is in stop mode, this function can also be used to prevent wind milling. In addition, it can be used for the purpose of braking using the motor to consume the braking energy resulting in a better controlled stop. Refer to the DC brake parameter 07-16 for DC braking during start.

**Notes:**

- The hold function at start is inactive when the hold frequency at start (11-43) is set to a value less than Fmin (01-08).
- The hold function at stop is inactive when the hold frequency at stop (11-45) is set to a value less than Fmin (01-08).

<b>11- 47</b>	<b>KEB Deceleration time</b>
<b>Range</b>	0.0~25.5 Sec

<b>11- 48</b>	<b>KEB detection level</b>
<b>Range</b>	200V: 190~210 V 400V: 380~420 V 575V: 540~570 V 690V: 540~684 V

KEB function can be used to keep the inverter from tripping on a under voltage condition due to a momentary power-loss. To enable the KEB function set parameter 11-47 to a value greater than 0.0 sec.

Upon detection of a power-loss the inverter uses the KEB deceleration time (11-47) to decelerate the motor and using the regenerative energy from the motor to maintain the DC-bus at a nominal level.

**11-48: KEB detection level**

If the DC-bus voltage falls below the value set in 11-48, the KEB is activated and the inverter starts decelerating according to the value set in 11-47.

To accelerate back to the original output frequency one of the digital inputs (03-00 to 03-07) set for 48 (KEB acceleration) has to be activated and the DC voltage has to rise above 11-48 + delta V (Delta V = +10V for 230V series, Delta V = +20 V for 460V Series, Delta V = +26 V for 575V Series, Delta V = +30 V for 690V Series).

Refer to the example in Figure 4.4.97.



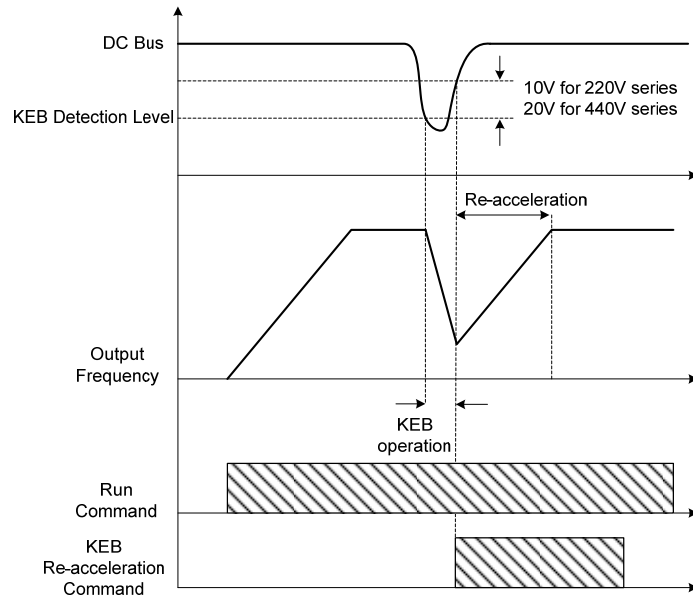
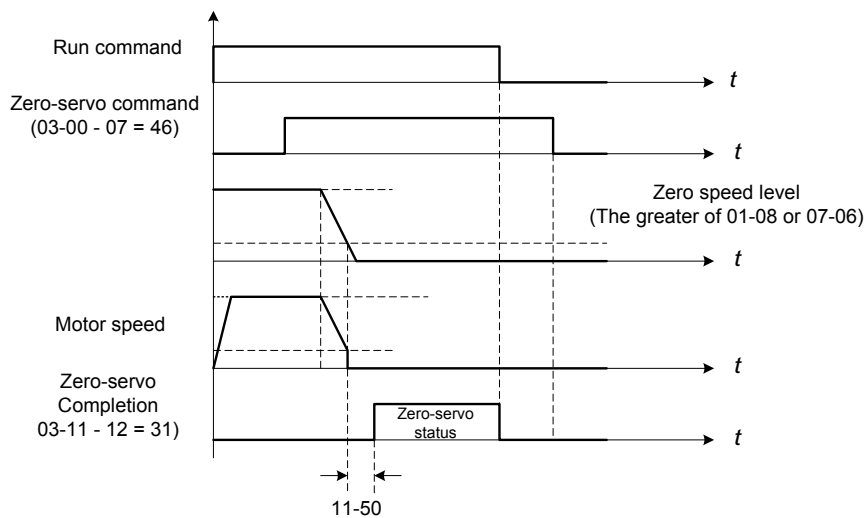

**Figure 4.4.97 KEB operation**

<b>11- 49</b>	<b>Zero-servo gain</b>
<b>Range</b>	0.01~5.00
<b>11- 50</b>	<b>Zero-servo count</b>
<b>Range</b>	0~4096
<b>11- 51</b>	<b>Braking selection of zero-speed</b>
<b>Range</b>	0: Zero-speed DC braking is disabled 1: Zero-speed DC braking is enabled

When the motor is stopped, the zero-servo function is used to maintain the motor shaft position in SV control mode.

Refer to the figure 4.4.98 for zero servo operation.



**Figure 4.4.98 Zero servo operation**

- Use one of multi-function digital inputs (03-00 to 03-07) set to 46 to execute the zero-servo command.
- If the frequency reference is lower than the zero speed level (the larger of 01-08 or 07-06 (DC braking start frequency)), zero servo operation is active (zero servo start position) and the motor shaft will remain in the same position even if the analog reference signal level is greater than 0.
- Deactivating multi-function input set for zero-servo, deactivates the zero-servo operation.
- Use multi-function digital outputs (03-11, 03-12 = 31) for zero-servo completed indication.
- Zero-servo count 11-50 is used when one of multi-function digital outputs is set to 31 (zero-servo completed).
- Zero-servo completion is enabled when the motor shaft position count falls within the zero-servo starting position  $\pm$  servo counts set in parameter 11-50.
- Zero-servo or normal operation command is active when zero-servo completion signal is turned off.

#### **11-49: Zero-servo gain setting**

Use the zero-servo gain parameter 11-49 to adjust the holding torque in zero-servo operation. If the set value is increased, the holding torque will increase but instability may occur.

When 11-49 is set to 1, if 1 circle of position error occurs, 1 rated motor speed will occur.

Do not use the zero-servo function at 100% of the inverter rated current as this may cause the inverter to overheat (OH1). Zero-servo may permanently be used to maintain 50 – 60% of the inverter rated current. Increase inverter rating if more is required.

#### **11-50: Zero-servo count**

Zero servo count is used to specify the zero-servo position offset from the zero-servo start position used for zero-servo completion.

#### **11-51: Operation selection of zero-speed braking**

In V/F control mode, the DC braking operation (without PG feedback) can be used to the motor shaft. Set 11-51 to select zero-speed braking operation to 1 to enable this function.

To use DC braking operation set parameter 00-02 (operation command selection) to 1 and parameter 00-05 (frequency reference selection) to 1, the operation command and frequency reference are now set for external control. When the frequency reference is 0V (or less than 4mA), and the operation command is turned on, the zero-speed 'DC' braking operation is activated and holding torque is generated using DC braking.

Refer to Figure 4.3.99 for more information on zero-speed DC braking operation.

**Note:** DC braking 07-07 is limited to 20% of the inverter rated current.

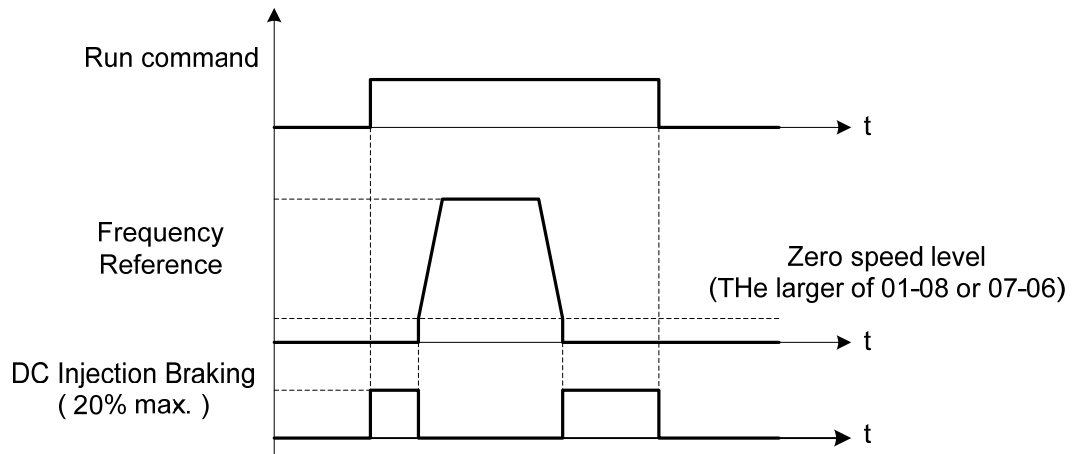
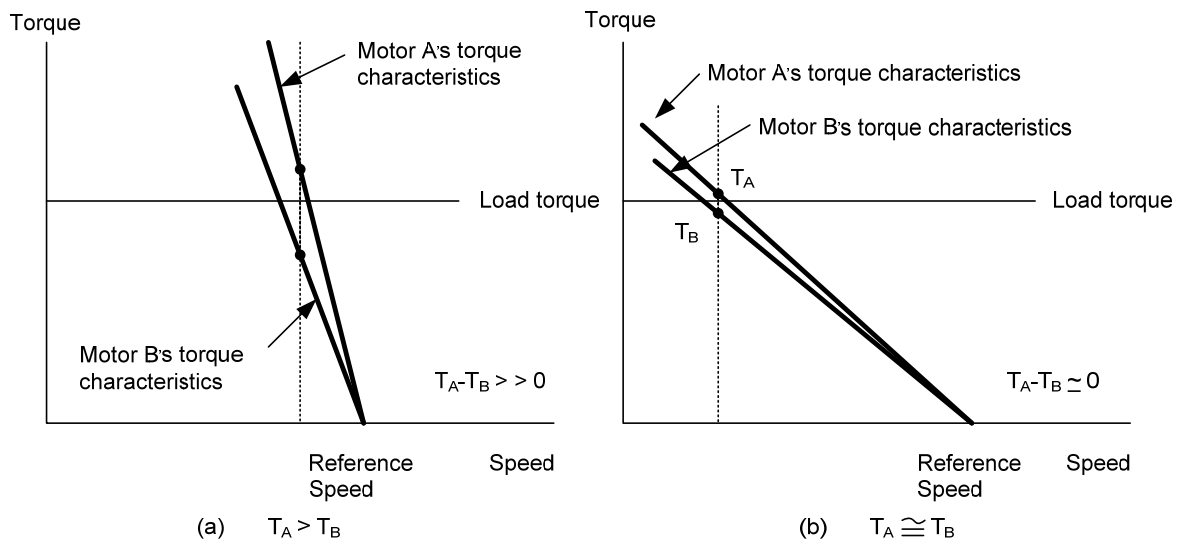

Figure 4.4.99 Zero-speed braking operation

<b>11-52</b>	<b>Droop control level</b>
<b>Range</b>	0.0~100.0%
<b>11-53</b>	<b>Droop control delay</b>
<b>Range</b>	0.01~2.00 Sec
<b>11- 76</b>	<b>Droop frequency level 1</b>
<b>Range</b>	【0.00~599.00】 Hz
<b>11- 77</b>	<b>Droop frequency level 2</b>
<b>Range</b>	【0.00~599.00】 Hz
<b>11- 78</b>	<b>Droop torque offset value</b>
<b>Range</b>	【0.00~100.00】 %

Droop control is used for load balancing when using two standard AC motors to drive the load in applications such as cranes and conveyors. When droop control is active the inverter reduces the speed when the torque reference rises and increases the speed when the torque reference drops.

- (a) Load balancing using the standard AC motors.  
The load torque of motor A,  $T_A >$  The load torque of motor B , $T_B$ .
- (b) Load balancing using high slippage AC motors.  
The load torque of motor A , $T_A$  is very close to the load torque of motor B , $T_B$ .



- Droop function can be used to approximate the characteristic of a high slippage motor. Set 11-52 to the percentage of the speed reduction that amounts to 100% of motor torque based on the maximum frequency (01-02).
- Droop function is disabled when 11-52 is set to 0.0%.

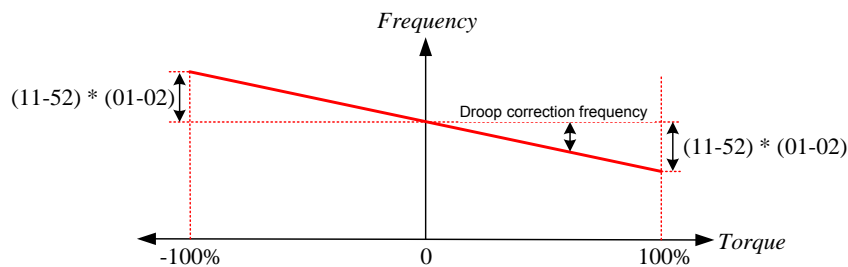

### 11-53: Droop control delay

This setting is used adjust the response speed of the droop function. Increase value in case of current oscillation.

Parameter 11-76 and 11-77 can be used to set the Droop Function starting operations when reaching the set frequency, the Speed Gain Adjustment Curve is shown in the Figure below.

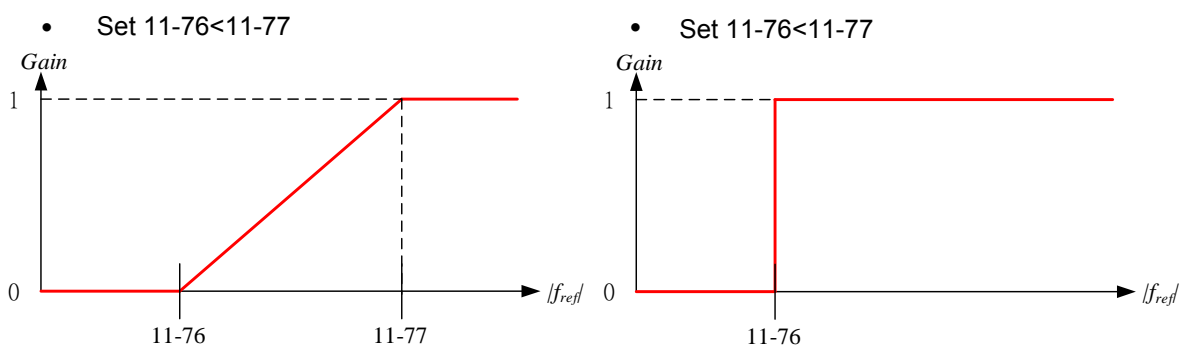

Parameter 11-78 can be used to set the Droop Function starting operations when reaching the set Torque Offset Value, the Torque Command Adjustment Curve is shown in the Figure below.

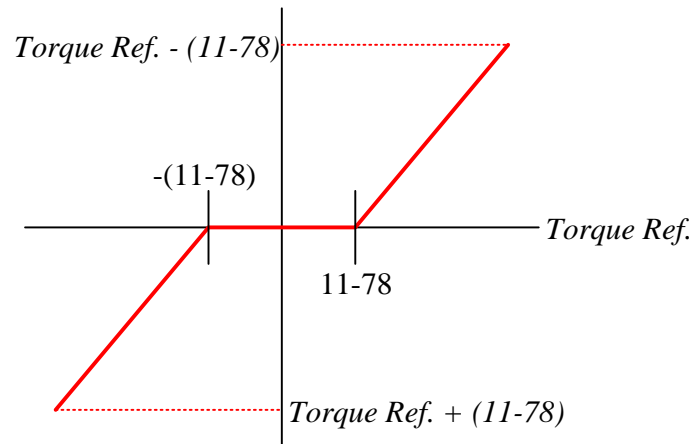

<b>11-54</b>	<b>Output KWHr initialization</b>
<b>Range</b>	<b>0:</b> Do not clear output KWHr <b>1:</b> Clear output KWHr

Reset kW-hour meter 12-67 (Accumulative Energy (kWHr)) and 12-68 (Accumulative Energy (MWHr)).

<b>11-55</b>	<b>STOP key selection</b>
<b>Range</b>	<b>0:</b> Stop key is disabled when the operation command is not provided by operator. <b>1:</b> Stop key is enabled when the operation command is not provided by operator.

**11-55= 0:** Stop button disabled when operation command is set for terminals (00-02=1) or communication (00-02=3).

**11-55= 1:** Stop button enabled

<b>11-56</b>	<b>UP/DOWN selection</b>
<b>Range</b>	<b>0:</b> UP/DOWN reference frequency adjustment with ENTER key. <b>1:</b> UP/DOWN reference frequency adjustment without ENTER key.

**11-56= 0:** Changing the reference frequency on the keypad in UP/DOWN control requires the ENTER button to be pressed for the inverter to accept the modified reference frequency.

**11-56= 1:** Changing the reference frequency on the keypad in UP/DOWN control immediately changes the reference frequency and there for the output frequency.

**Note:** The reference frequency can be changed (up or down) via the keypad or by setting one of multi-functional digital input terminals (03-00, 03-07) to 8 and 9. Refer to instructions of (03-00 - 03-07 = 8 or 9).

<b>11- 58</b>	<b>Record reference frequency</b>
<b>Range</b>	<b>0:</b> Disable <b>1:</b> Enable

This function is enabled only when one of multi-function digital input terminals (03-00 to 03-07) is set to 11 (Inhibit ACC / DEC command).

**11-58= 0:** When ACC / DEC inhibition command is enabled, the motor will stop accelerate or decelerate, and the frequency at the moment will be used as frequency command. If ACC / DEC inhibition command is disabled or stop command enabled, the frequency command will set to original frequency. Besides, when stop command enabled, or the power is cut off and reset. The frequency will be set to 0 Hz

Note: If ACC / DEC inhibition command is enabled before running, it will display STP0 after running, due to there is no reference frequency record.

**11-58= 1:** When ACC / DEC inhibition command is enabled, the output frequency will be recorded and to be used as frequency command. When it switches to stop or the power is cut off and reset, the ACC / DEC inhibition command is still enabled, the frequency command is still recorded and the frequency command is set to the frequency that was recorded.

Please refer to the following figure.

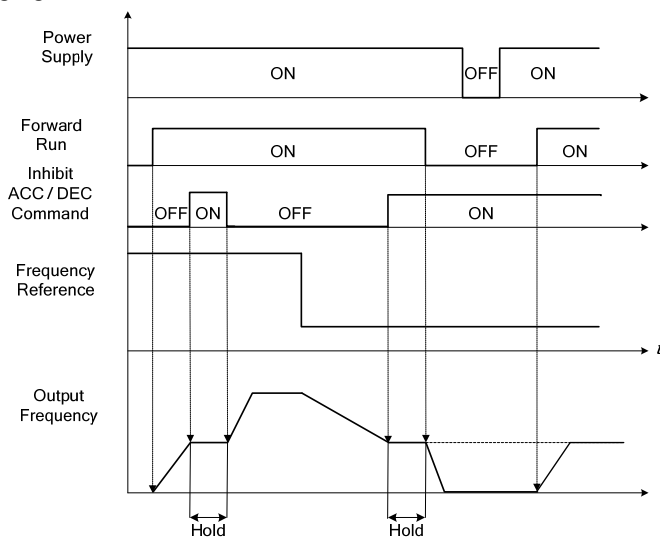

<b>11- 59</b>	<b>Gain of Preventing Oscillation</b>
<b>Range</b>	0.00~2.50

It is used to adjust preventing oscillation function.

If the oscillation in driving motor occurs at normal duty, it is required to increase the setting value gradually in the unit of 0.01.

<b>11- 60</b>	<b>Upper Limit of Preventing Oscillation</b>
<b>Range</b>	0~100 %

It is required to limit the preventing oscillation upper limit within the setting value.

<b>11- 61</b>	<b>Time Parameter of Preventing Oscillation</b>
<b>Range</b>	0~100

Adjust the response of oscillation function. (Time parameter of adjust preventing oscillation function delay.)

<b>11- 62</b>	<b>Selection of Preventing Oscillation</b>
<b>Range</b>	0: Mode 1 1: Mode 2 2: Mode 3

When 11-62=0 and 1: Mode 1 and 2, the response to preventing oscillation is slower.

When 11-62=2: Mode 3, the response to preventing oscillation is faster.

<b>11- 63</b>	<b>Strong Magnetic Selection</b>
<b>Range</b>	0: Disable 1: Enable

11-63=0: It has no function of flux-strengthening, the no-load current of high speed and low speed are the same.

11-63=1: It has function of flux-strengthening, the torque of low speed is higher, but the no-load current is also higher, it is suitable for big load in low speed.

<b>11- 69</b>	<b>Gain of Preventing Oscillation 3</b>
<b>Range</b>	0.00~200.00 %

Adjust the response of Gain of Preventing Oscillation 3

If occur vibration with motor in ND mode, please increase by 0.01 unit to set.

<b>11- 70</b>	<b>Upper Limit of Preventing Oscillation 3</b>
<b>Range</b>	0.01~100.00 %

It is required to limit the preventing oscillation 3 upper limit within the setting value.

<b>11- 71</b>	<b>Time Parameter of Preventing Oscillation 3</b>
<b>Range</b>	0~30000 ms

Adjust the response of oscillation 3 function. (Time parameter of adjust preventing oscillation function delay.)

<b>11- 72</b>	<b>Gain of Preventing Oscillation for switch frequency 1</b>
<b>Range</b>	0.01~300.00 Hz
<b>11- 73</b>	<b>Gain of Preventing Oscillation for switch frequency 2</b>
<b>Range</b>	0.01~300.00 Hz

Refer to the following for the setting of 11-72 and 11-73.

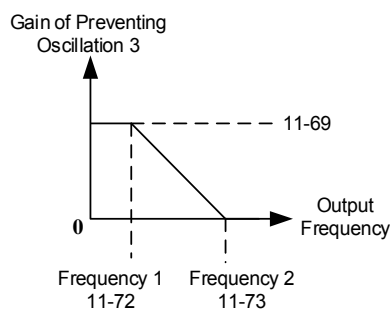

<b>11- 79</b>	<b>LOC/REM Keypad Button Selection</b>
<b>Range</b>	0: Forward / Reverse control 1: Local / Remote control

The user can set the function of the LOC/ROM button according to the requirement.

11-79=0: Forward and reverse control, can be to set the direction of rotation.

11-79=1: Local and remote control, can switch the panel/external control directly, adjust with external control logic parameters.

<b>11- 80</b>	<b>Local / Remote Selection Mode</b>
<b>Range</b>	0: Allow Switching Directly 1: Switching Prohibited at Running 2: Stop after Switching

The user switches the local / remote mode according to the requirement, in order to protect the personnel and the machine, the user can restrict the local/remote switching through the protection level between each mode to ensure the safety of the switching process.

<b>11- 81</b>	<b>OVP4 Level (%)</b>
<b>Range</b>	100~200%
<b>11- 82</b>	<b>OVP4 gain</b>
<b>Range</b>	0~256

The OVP mode is mainly used to suppress the recharge voltage generated during deceleration, which causes the driver to exceed the protection limit and generate an OV fault signal.

The way of consuming and recovering the voltage in OVP mode 4 is to return the energy to the motor side as a virtual work, thereby venting the voltage to ensure that the drive can operate normally during the rapid deceleration process, but please note that this method is to recharge the energy to the motor side, it will affect the service life of the motor. Therefore, when this mode is turned on, it is necessary to evaluate whether it is suitable for the occasion.



## 12-Monitoring Parameters

12-00	Display screen selection (LED)
<b>Range</b>	<p><b>Highest bit =&gt; 0 0 0 0 0 &lt;= lowest bit</b></p> <p>The value range of each bit is 0~7 from the highest bit to the lowest bit,</p> <p><b>0:</b> No display  <b>1:</b> Output current  <b>2:</b> Output voltage  <b>3:</b> DC bus voltage  <b>4:</b> Heatsink temperature  <b>5:</b> PID feedback  <b>6:</b> AI1 value  <b>7:</b> AI2 value</p>

**Note:** The highest bit is used for power-up monitor. The 4 least significant bits can be used to customize the display sequence see chapter 4.1.3.

A510s 220V 50HP and higher models and 440V 100HP and higher models, does not support heatsink temperature display function.

12-01	PID feedback display mode (LED)
<b>Range</b>	<p><b>0:</b> Display the feedback value in integer (xxx)</p> <p><b>1:</b> Display the feedback value with one place after the decimal point (xx.x)</p> <p><b>2:</b> Display the feedback value (x.xx) with two places after the decimal point</p>

12-02	PID feedback display unit setting (LED)
<b>Range</b>	<p><b>0:</b> xxxxx (no unit)</p> <p><b>1:</b> xxxPb (pressure)</p> <p><b>2:</b> xxxFL (flow)</p>

When 12-00=xxx5, LED preset screen will display PID feedback. Parameter 12-01 will refer to the value of 10-33 and display five-digit XXX.XX.

For example,

When 10-33=9999, preset screen of 12-01=0 will display 99, 12-01=1 will display 99.9, and 12-01=2 will display 99.99.

If setting of 12-02 is also referred, 12-01=1 and 12-02=1 will display five-digit 99.9Pb; 12-01=2 and 12-02=2 will display 9.99FL and decimal 9 will be hidden.

12-03	Line Speed Display (LED)
<b>Range</b>	<b>【0~60000】 RPM</b>
12-04	Line Speed Display Mode (LED)
<b>Range</b>	<p><b>【0】 : Display Inverter Output Frequency</b></p> <p><b>【1】 : Line Speed Display at Integer.(xxxxx)</b></p> <p><b>【2】 : Line Speed Display at One Decimal Place. (xxxx.x)</b></p> <p><b>【3】 : Line Speed Display at Two Decimal Places. (xxx.xx)</b></p> <p><b>【4】 : Line Speed Display at Three Decimal Places. (xx.xxx)</b></p>

12-04≠0, Inverter displays the line speed at stop, operation or the modification of frequency.

12-03 is set to the maximum line speed and corresponds to the maximum output frequency.

For example, if the line speed display of 12-03 is 1800, the keypad display is 900 when frequency output is 30Hz.

<b>12-05</b>	<b>Status display of digital input terminal (LED / LCD)</b>
<b>Range</b>	Read-only

Terminals S1-S8 are represented using two segments of each digit. Segment turns on when input is active. The bottom segments of each of the first three digits are used to represent the digital outputs (R1, R2, DO1). Segments turn on when output is active.

**Example1:** S1~S8, R1, R2 and DO1 are ON

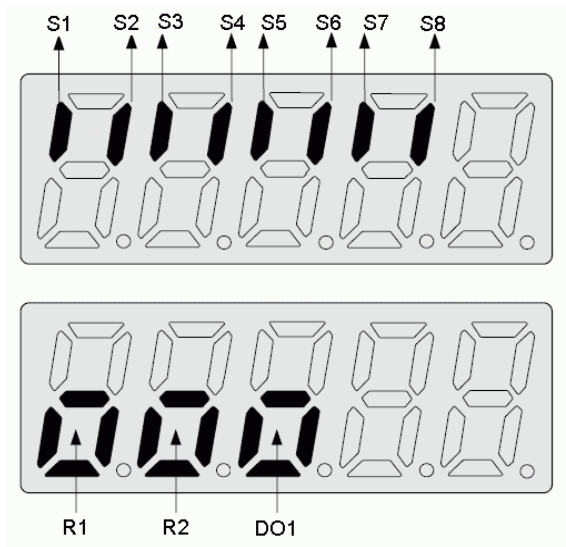

**Example2:** S1~S8, R1, R2 and DO1 are OFF

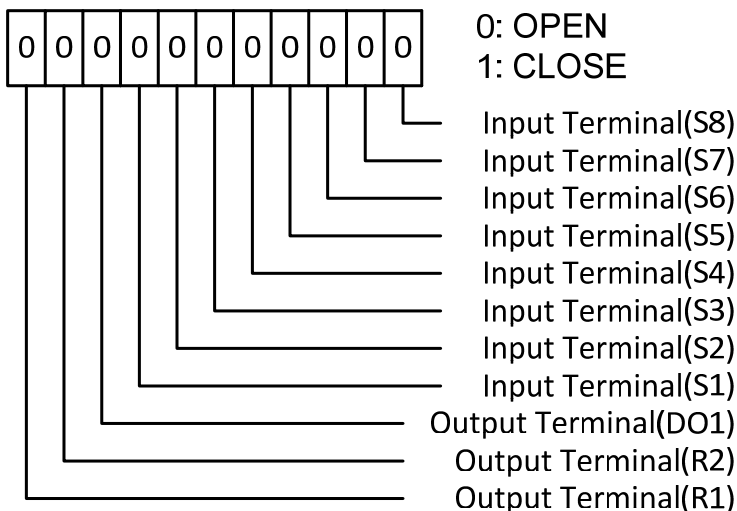

**Note:** Refer to section 4.3 for monitors 12-11~12-64.

**Monitoring parameter 12-34:** Only for JN5-PG-L, JN5-PG-O, JN5-PG-PM optional card and manual pulse generator (MPG) function.

**Monitoring parameter 12-66:** Encoder Angle

Encoder PG pulse (20-27) is set to correct connection with the encoder wiring. Make the motor rotate forwardly at non-run state and the angle will accumulate to 360° at two times; if make the motor rotate reversely, the angle will regress to 360° at two times.

**Monitoring parameter 12-67:** Cumulative Energy (KWHr) & **12-68:** Cumulative Energy (MWHr)

Initialization of Cumulative Energy of 11-54 can clear these monitoring parameters.

**Monitoring parameter 12-38:** PID setting & **12-39:** PID Feedback

Refer to the setting of 10-33~10-35.

**Monitoring parameter 12-76:** No-Load Voltage Output

It is required to be with the descriptions of parameter 02-09 (excitation current of motor 1) and parameter 17-09 (motor excitation current).

**Monitoring parameter 12-78:** Z-Phase Bias Value

It is required to be with the parameter 21-43 (Offset Angle).

**Monitoring parameter 12-79:** Pulse Input Percentage

Refer to parameter 03-30 (Selection of pulse input)

Note: It can perform run command when viewing monitoring parameters (12-05~12-82).

### 13-Maintenance Parameters

<b>13-00</b>	<b>Inverter Capacity Selection</b>
<b>Range</b>	----

Inverter model:	13- 00 display	Inverter model:	13- 00 display
A510-2001-XXX	201	A510-4001-XXX	401
A510-2002-XXX	202	A510-4002-XXX	402
A510-2003-XXX	203	A510-4003-XXX	403
A510-2005-XXX	205	A510-4005-XXX	405
A510-2008-XXX	208	A510-4008-XXX	408
A510-2010-XXX	210	A510-4010-XXX	410
A510-2015-XXX	215	A510-4015-XXX	415
A510-2020-XXX	220	A510-4020-XXX	420
A510-2025-XXX	225	A510-4025-XXX	425
A510-2030-XXX	230	A510-4030-XXX	430
A510-2040-XXX	240	A510-4040-XXX	440
A510-2050-XXX	250	A510-4050-XXX	450
A510-2060-XXX	260	A510-4060-XXX	460
A510-2075-XXX	275	A510-4075-XXX	475
A510-2100-XXX	2100	A510-4100-XXX	4100
A510-2125-XXX	2125	A510-4125-XXX	4125
A510-2150-XXX	2150	A510-4150-XXX	4150
		A510-4175-XXX	4175
		A510-4215-XXX	4215
		A510-4270-XXX	4270
		A510-4300-XXX	4300
		A510-4375-XXX	4375
		A510-4425-XXX	4425

<b>13-01</b>	<b>Software version</b>
<b>Range</b>	----

<b>13-02</b>	<b>Clear Cumulative Operation Hours</b>
<b>Range</b>	<b>0:</b> Disable to Clear Cumulative Operation Hours <b>1:</b> Clear Cumulative Operation Hours

<b>13- 03</b>	<b>Cumulative operation hours 1</b>
<b>Range</b>	0~23 hours

<b>13- 04</b>	<b>Cumulative operation hours 2</b>
<b>Range</b>	0~65534 days

When 13-02=1, time set of 13-03/ 13-04 will be deleted.

<b>13-05</b>	<b>Selection of cumulative operation time</b>
<b>Range</b>	<b>0:</b> Accumulative operation time while power on <b>1:</b> Accumulative operation time when it is operating.

**13-05= 0:** Inverter logs the time while the inverter is powered-up.

**13-05= 1:** Inverter logs the time when the inverter is running.

<b>13-06</b>	<b>Parameters lock</b>
<b>Range</b>	<b>0:</b> Parameters are read-only except 13-06 and main frequency <b>1:</b> Only User Defined Parameters <b>2:</b> All parameters are writable

When 13-06=0, only parameter 13-06 and frequency command parameter in main screen can be set but other parameters are read-only.

When 13-06=1, only user parameters (00-41~00-56) are enabled. Please refer to the instruction of parameters 00-41~00-56.

Note: it is only enabled in LCD keypad.

When 13-06=2, all parameters are writable except for the read-only parameters.

Note:

Main frequency setting is 12-16. The value is equal to frequency setting of speed-stage 0 (05-01) in LCD keypad. LED Main Frequency can be set in the main frequency display

<b>13-07</b>	<b>Parameter Lock Key Code</b>
<b>Range</b>	<b>【00000~65534】</b>

- When parameter lock key code is enabled (13-07>0), all parameter except main frequency can't be modified. Only unlock the key code, modify the parameters is allowable.
- Setting parameter lock key number example:

Step 1

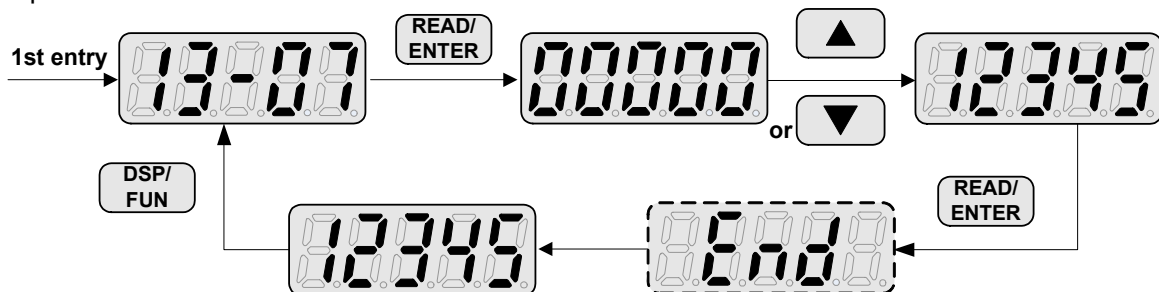

Step 2:

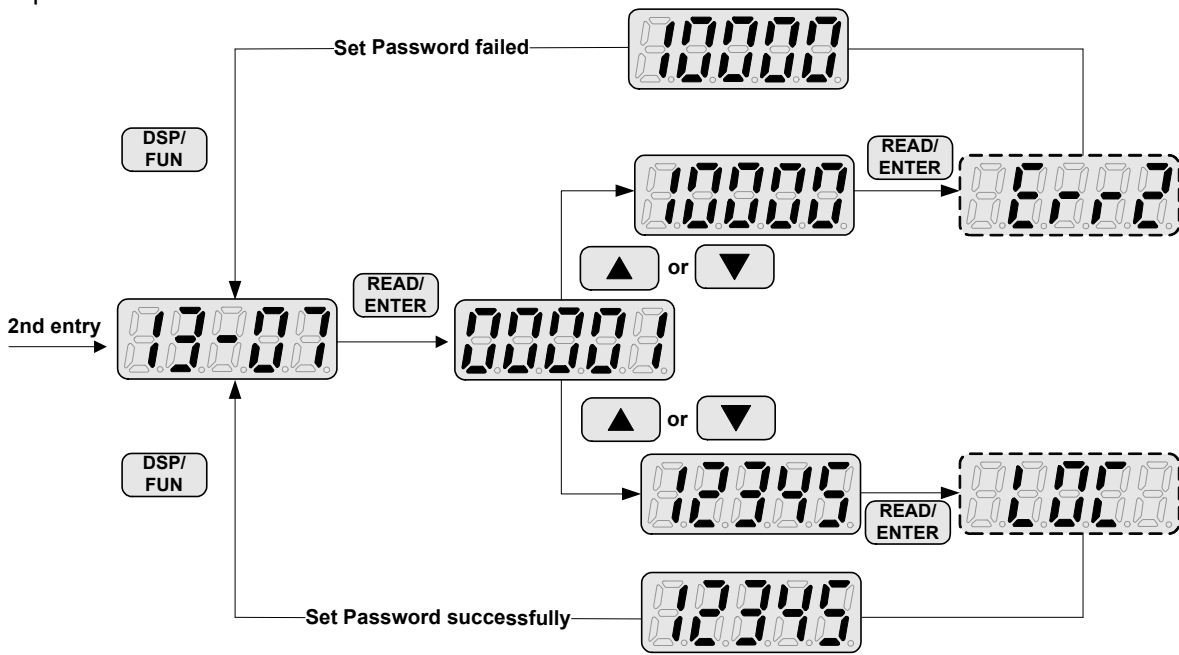

Lifting lock key code (password):

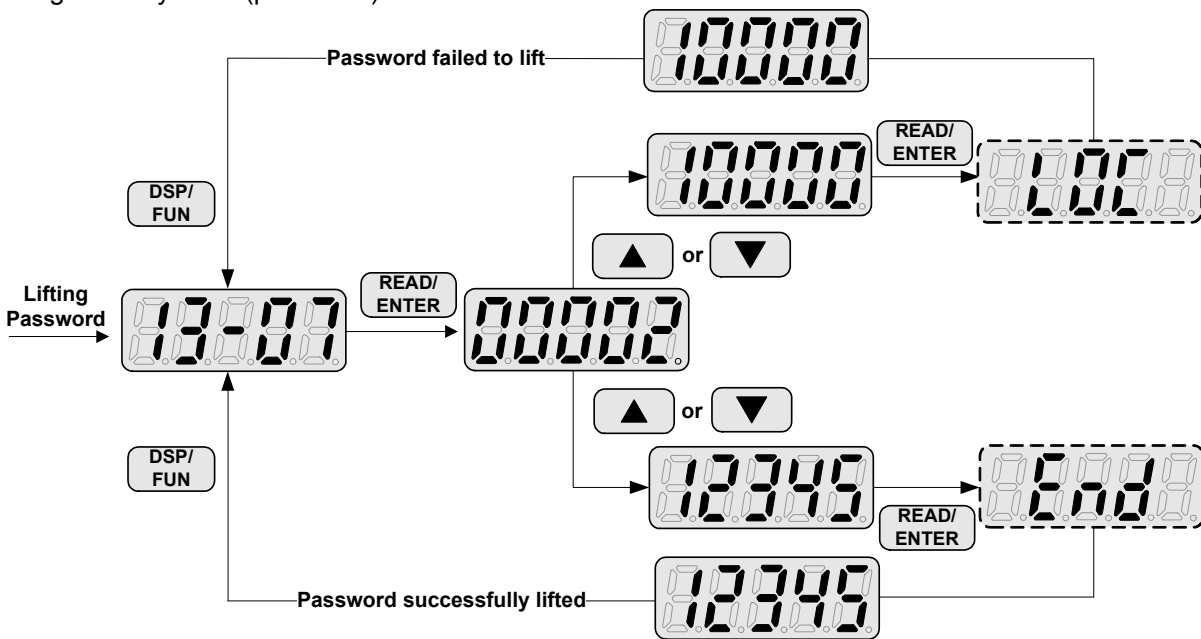

13-08	Restore factory setting / Initialize
<b>Range</b>	<p><b>0</b> : No initialization</p> <p><b>2</b> : 2 wire initialization (60Hz)(220V/440V/690V)</p> <p><b>3</b> : 3 wire initialization (60Hz)(220V/440V/690V)</p> <p><b>4</b> : 2 wire initialization (50Hz)(230V/415V)</p> <p><b>5</b> : 3 wire initialization (50Hz)(230V/415V)</p> <p><b>6</b> : 2 wire initialization (50Hz)(200V/380V/575V)</p> <p><b>7</b> : 3 wire initialization (50Hz)(200V/380V/575V)</p> <p><b>8</b> : PLC initialization</p> <p><b>9</b> : 2 wire Initialization (60Hz)(230V/460V)</p> <p><b>10</b> : 3 wire Initialization (60Hz)(230V/460V)</p> <p><b>11</b> : 2 wire Initialization (60Hz)(230V/400V)</p> <p><b>12</b> : 3 wire Initialization (60Hz)(230V/400V)</p> <p><b>13</b> : 2 wire Initialization (50Hz)(230V/400V)</p> <p><b>14</b> : 3 wire Initialization (50Hz)(230V/400V)</p> <p><b>15</b> : 2 wire Initialization (50Hz)(220V/380V)</p> <p><b>16</b> : 3 wire Initialization (50Hz)(220V/380V)</p>

Use parameter 13-08 to initialize the inverter to factory default. It is recommended to write down the modified parameters before initializing the inverter. After initialization, the value of 13-08 will return to zero automatically.

**13-08=2:** 2-wire initialization (60Hz) (220V/440V/690V)

Multi-function digital input terminal S1 controls forward operation / stop command, and S2 controls reverse operation / stop command. Refer to Figure 4.4.1. Inverter input voltage (01-14) is automatically set to 220V (200V class) or 440V (400V class) or 690V (660V class).

When 01-00V/Curve= F, 01-02 will automatically set to 60Hz.

**13-08=3:** 3-wire initialization (60Hz) (220V/440V/690V)

Multi-function digital input terminal S7 controls the forward / reverse direction, and terminals S1 and S2 are set for 3-wire start operation and stop command. Refer to Figure 4.4.2 and Figure 4.4.3 for 3-wire type operation mode. Inverter input voltage (01-14) is automatically set to 220V (200V class) or 440V (400V class) or 690V (660V class).

When 01-00V/Curve= F, 01-02 will automatically set to 60Hz.

**13-08=4:** 2-wire initialization (50Hz) (230V/415V)

Multi-function digital input terminal S1 controls forward operation / stop command, and S2 controls reverse operation / stop command. Refer to Figure 4.4.1. Inverter input voltage (01-14) is automatically set to 230V (200V class) or 415V (400V class).

When 01-00V/Curve= F, 01-02 will automatically set to 50Hz.

**13-08=5:** 3-wire initialization (50Hz) (230V/415V)

Multi-function digital input terminal S5 controls the forward / reverse direction, and terminals S1 and S2 are set for 3-wire start operation and stop command. Inverter input voltage (01-14) is automatically set to 230V (200V class) or 415V (400V class).

When 01-00V/Curve= F, 01-02 will automatically set to 50Hz.

**13-08=6:** 2-wire initialization (50Hz) (200V/380V/575V)

Multi-function digital input terminal S1 controls forward operation / stop command, and S2 controls reverse operation / stop command. Refer to Figure 4.4.1. Inverter input voltage (01-14) is automatically set to 200V (200V class) or 380V (400V class) or 575V (660V class).

When 01-00V/Curve= F, 01-02 will automatically set to 50Hz.

**13-08=7:** 3-wire initialization (50Hz) (200V/380V/575V)

Multi-function digital input terminal S5 controls the forward / reverse direction, and terminals S1 and S2 are set for 3-wire start operation and stop command. Inverter input voltage (01-14) is automatically set to 200V (200V class) or 380V (400V class) or 575V (660V class).

When 01-00V/Curve= F, 01-02 will automatically set to 50Hz.

**13-08=8:** PLC initialization

Clear built-in PLC ladder logic and related values.

**13-08=9:** 2 wire Initialization (60Hz) (230V/460V)

Multi-function digital input terminal S1 controls forward operation / stop command, and S2 controls reverse operation / stop command. Refer to Figure 4.4.1. Inverter input voltage (01-14) is automatically set to 230V (200V class) or 460V (400V class).

When 01-00V/Curve= F, 01-02 will automatically set to 60Hz.

**13-08=10:** 3 wire Initialization (60Hz) (230/460V)

Multi-function digital input terminal S7 controls the forward / reverse direction, and terminals S1 and S2 are set for 3-wire start operation and stop command. Refer to Figure 4.4.2 and Figure 4.4.3 for 3-wire type operation mode. Inverter input voltage (01-14) is automatically set to 230V (200V class) or 460V (400V class).

When 01-00V/Curve= F, 01-02 will automatically set to 60Hz.

**13-08=11:** 2 wire Initialization (60Hz) (230/400V)

Multi-function digital input terminal S1 controls forward operation / stop command, and S2 controls reverse operation / stop command. Refer to Figure 4.4.1. Inverter input voltage (01-14) is automatically set to 230V (200V class) or 400V (400V class).

When 01-00V/Curve= F, 01-02 will automatically set to 60Hz.

**13-08=12:** 3 wire Initialization (60Hz) (230/400V)

Multi-function digital input terminal S7 controls the forward / reverse direction, and terminals S1 and S2 are set for 3-wire start operation and stop command. Refer to Figure 4.4.2 and Figure 4.4.3 for 3-wire type operation mode. Inverter input voltage (01-14) is automatically set to 230V (200V class) or 400V (400V class).

When 01-00V/Curve= F, 01-02 will automatically set to 60Hz.

**13-08=13:** 2 wire Initialization (50Hz) (230/400V)



Multi-function digital input terminal S1 controls forward operation / stop command, and S2 controls reverse operation / stop command. Refer to Figure 4.4.1. Inverter input voltage (01-14) is automatically set to 230V (200V class) or 400V (400V class).

When 01-00V/Curve= F, 01-02 will automatically set to 50Hz.

**13-08=14: 3 wire Initialization (50Hz) (230/400V)**

Multi-function digital input terminal S7 controls the forward / reverse direction, and terminals S1 and S2 are set for 3-wire start operation and stop command. Refer to Figure 4.4.2 and Figure 4.4.3 for 3-wire type operation mode. Inverter input voltage (01-14) is automatically set to 230V (200V class) or 400V (400V class).

When 01-00V/Curve= F, 01-02 will automatically set to 50Hz.

**13-08=15: 2 wire initialization (220V/380V, 50Hz)**

Multi-function digital input terminal S1 controls forward operation / stop command, and S2 controls reverse operation / stop command. Refer to Fig.4.4.1. The input voltage (01-14) will be set to 220V (200V class) or 380V (400V class) automatically and when 01-00 (V/F curve) is set to F, the maximum frequency of 01-12 will be set to 50Hz automatically.

**13-08=16: 3 wire initialization (220V/380V, 50Hz)**

Multi-function digital input terminal S7 controls the forward / reverse direction, and terminals S1 and S2 are set for 3-wire start operation and stop command. Refer to Figure 4.4.2 and Figure 4.4.3 for 3-wire type operation mode. The input voltage (01-14) will be set to 220V (200V class) or 380V (400V class) automatically and when 01-00 (V/F curve) is set to F, the maximum frequency of 01-12 will be set to 50Hz automatically.

Parameters don't be influenced by restore factory setting / Initialize (13-08)

No.	Parameters
00-00	Control Mode Selection
00-04	Language
00-27	HD/ND Mode Selection ***
01-00	V/F Curve Selection
01-26	V/F Curve Selection of Motor 2
13-00	Inverter Capacity Selection
13-03	Cumulative Operation Hours 1
13-04	Cumulative Operation Hours 2
13-05	Selection of Cumulative Operation Time

<b>13-09</b>	<b>Fault history clearance function</b>
<b>Range</b>	<b>0:</b> Do not clear fault history <b>1:</b> Clear fault history

**13-09=1:** Clears inverter fault history.

Note: parameters 12-11~12-15/12-45~12-64 are cleared as well.

<b>13-10</b>	<b>Parameter Password Function 2</b>
<b>Range</b>	0 ~ 9999

<b>13-11</b>	<b>C/B CPLD Ver.</b>
<b>Range</b>	0.00~9.99

This parameter displays the CPLD software version on the control board. It is only displayed on the control board with CPLD.

<b>13-12</b>	<b>PG Card Id</b>
<b>Range</b>	0~255

This parameter displays the ID of option card on the control board. It is only displayed coupled with the option card.

- 【0】** : none
- 【1】** : PG-L
- 【2】** : PG-O
- 【3】** : PG-PM
- 【4】** : PG-PMS
- 【5】** : PG-PMR

<b>13-13</b>	<b>PG Card Ver.</b>
<b>Range</b>	0.00~9.99

This parameter displays the CPLD software version of the option card on the control board. It is only displayed coupled with the option card.

<b>13-14</b>	<b>Fault Storage Selections</b>
<b>Range</b>	<b>0:</b> Fault Messages of Auto Restart are not saved. <b>1:</b> Fault Messages of Auto Restart are saved.

**13-14=0,**

The fault messages are not saved in the fault history (12-46~12-49 & 13-21~13-50) in the process of restart when the auto reset function is active.

**13-14=1,**

The fault messages are saved in the fault history (12-46~12-49 & 13-21~13-50) in the process of restart when the auto reset function is active.

**Note:** Parameters 13-21~13-50 are 30 Fault History: When it detect fault, inverter will store to fault history. If the fault occurs again, parameter 13-21 will change to parameter 13-22.

**14-PLC Parameters**

14-00	T1 set value 1
14-01	T1 set value 2 (mode 7)
14-02	T2 set value 1
14-03	T2 set value 2 (mode 7)
14-04	T3 set value 1
14-05	T3 set value 2 (mode 7)
14-06	T4 set value 1
14-07	T4 set value 2 (mode 7)
14-08	T5 set value 1
14-09	T5 set value 2 (mode 7)
14-10	T6 set value 1
14-11	T6 set value 2 (mode 7)
14-12	T7 set value 1
14-13	T7 set value 2 (mode 7)
14-14	T8 set value 1
14-15	T8 set value 2 (mode 7)
<b>Range</b>	0~9999

14-16	C1 set value
14-17	C2 set value
14-18	C3 set value
14-19	C4 set value
14-20	C5 set value
14-21	C6 set value
14-22	C7 set value
14-23	C8 set value
<b>Range</b>	0~65535

14-24	AS1 set value 1
14-25	AS1 set value 2
14-26	AS1 set value 3
14-27	AS2 set value 1
14-28	AS2 set value 2
14-29	AS2 set value 3
14-30	AS3 set value 1
14-31	AS3 set value 2
14-32	AS3 set value 3
14-33	AS4 set value 1
14-34	AS4 set value 2
14-35	AS4 set value 3
<b>Range</b>	0~65535

14-36	MD1 set value 1
14-37	MD1 set value 2
14-38	MD1 set value 3
14-39	MD2 set value 1
14-40	MD2 set value 2
14-41	MD2 set value 3
14-42	MD3 set value 1
14-43	MD3 set value 2
14-44	MD3 set value 3
14-45	MD4 set value 1
14-46	MD4 set value 2
14-47	MD4 set value 3
<b>Range</b>	0~65535

Please refer to section 4.5 for built-in PLC function

### 15-PLC Monitoring Parameters

15-00	T1 current value 1
15-01	T1 current value 2 (mode 7)
15-02	T2 current value 1
15-03	T2 current value 2 (mode 7)
15-04	T3 current value 1
15-05	T3 current value 2 (mode 7)
15-06	T4 current value 1
15-07	T4 current value 2 (mode 7)
15-08	T5 current value 1
15-09	T5 current value 2 (mode 7)
15-10	T6 current value 1
15-11	T6 current value 2 (mode 7)
15-12	T7 current value 1
15-13	T7 current value 2 (mode 7)
15-14	T8 current value 1
15-15	T8 current value 2 (mode 7)
<b>Range</b>	0~9999

15-16	C1 current value
15-17	C2 current value
15-18	C3 current value
15-19	C4 current value
15-20	C5 current value
15-21	C6 current value
15-22	C7 current value
15-23	C8 current value
<b>Range</b>	0~65535

15-24	AS1 current value
15-25	AS2 current value
15-26	AS3 current value
15-27	AS4 current value
15-28	MD1 current value
15-29	MD2 current value
15-30	MD3 current value
15-31	MD4 current value
15-32	TD current value
<b>Range</b>	0~65535

<b>16-LCD Function group</b>	
------------------------------	--

<b>16-00</b>	<b>Main screen monitoring</b>
<b>Range</b>	5~82

<b>16-01</b>	<b>Sub-screen monitoring 1</b>
<b>Range</b>	5~82

<b>16-02</b>	<b>Sub-screen monitoring 2</b>
<b>Range</b>	5~82

At power-up the inverter shows two monitor section on the display, main monitor section and the sub-screen monitor section (smaller font).

Choose the monitor signal to be displayed as the main-screen monitor screen in parameter 16-00, and the monitor signals to be displayed on the sub-screen monitor in parameters 16-01 and 16-02, similar to monitor parameters 12-5 ~ 12-82.

<b>16-03</b>	<b>Display unit</b>
<b>Range</b>	<b>0:</b> Frequency display unit is Hz (Resolution is 0.01Hz) <b>1:</b> Frequency display unit is % (Resolution is 0.01%) <b>2:</b> Frequency display unit is rpm. <b>3~39:</b> Reserved <b>40~9999:</b> 100% is XXXX with no decimals (integer only) <b>10001~19999:</b> 100% is XXX.X with 1 decimal <b>20001~29999:</b> 100% is XX.XX with 2 decimals <b>30001~39999:</b> 100% is X.XXX with 3 decimals

<b>16-04</b>	<b>Engineering unit</b>
<b>Range</b>	<b>0:</b> No Unit <b>1:</b> FPM <b>2:</b> CFM <b>3:</b> PSI <b>4:</b> GPH <b>5:</b> GPM <b>6:</b> IN <b>7:</b> FT <b>8:</b> /s <b>9:</b> /m <b>10:</b> /h <b>11:</b> °F <b>12:</b> inW <b>13:</b> HP <b>14:</b> m/s <b>15:</b> MPM <b>16:</b> CMM <b>17:</b> W <b>18:</b> KW <b>19:</b> m <b>20:</b> °C <b>21:</b> RPM <b>22:</b> Bar <b>23:</b> Pa <b>24:</b> Kpa <b>25:</b> PRS <b>26:</b> SPM

(1). Display unit of digital operator (16-03)

Set the units of the following items to be displayed, the frequency reference (05-01, 00-18, 06-01~06-15) and the monitoring frequency 12-16, 12-17 (Output frequency)

(2). Display unit of engineering (16-04).

When 16-03 = 00040-39999, engineering units are enabled. The displayed set range and the frequency range of unit (05-01, 06-01~06-15) as well as the monitoring frequency (12-16, 12-17) are changed by parameters 16-04 and 16-03.

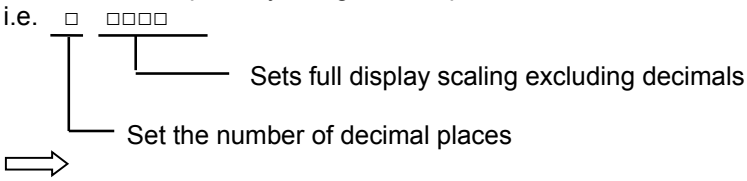
16-03	Set / displayed contents			
0	0.01 Hz			
1	0.01 % (maximum output frequency 01-02=100%)			
2	Frequency display unit is rpm			
3 - 39	Reserved			
00040 - 39999	Set the decimal point by using the fifth place. i.e. $\square \square \square \square$  ⇒ <b>00040 - 09999:</b> $\square \square \square \square$ (Integer only e.g. 1000 ) <b>10001 - 19999:</b> $\square \square \square . \square$ (1 decimal place e.g. 10.0) <b>20001 - 29999:</b> $\square \square . \square \square$ (2 decimal places, e.g. 10.00) <b>30001 - 39999:</b> $\square . \square \square \square$ (3 decimal places, e.g. 10.000) <example>			
	16-03	Display	Display unit	
	00040 – 09999	$\square \square \square \square$	use 16-04 setting	<b>Example:</b> 100 % speed is 0200 > set 16-03=00200 (from 05-01, 06-01 to 06-15, set range from 0040 to 9999). > set 16-04=0 (no unit)
	10001 – 19999	$\square \square \square . \square$		<b>Example:</b> 100 % speed is 200.0 CFM > set 16-03=12000 (05-01, 06-01 to 06-15, set range from 0000 to 9999). > set 16-04=2 (CFM) > 60% speed will be displayed as 120.0 CFM
	20001 – 29999	$\square \square . \square \square$		<b>Example:</b> 100 % speed is 65.00°C > set 16-03=26500 (05-01, 06-01 to 06-15, set range from 0000 to 9999) > set 16-04=20 (°C) > 60% of speed is displayed as 39.00 °C
30001 – 39999	$\square . \square \square \square$	<b>Example:</b> 100 % speed is 2.555 m/s > set 16-03=32555 > set 16-04=14 (m/s) > 60% speed is displayed as 1.533 m/s		

<b>16-05</b>	<b>LCD backlight</b>
<b>Range</b>	0~7

Adjust the screen contrast of the digital operator. If it is set to 0, the screen backlight is turned off.

<b>16-07</b>	<b>Copy function selection</b>
<b>Range</b>	0: Do not copy parameter 1: Read inverter parameters and save to the keypad 2: Write the keypad parameters to inverter 3: Compare parameters of inverter and keypad

<b>16-08</b>	<b>Selection of allowing reading</b>
<b>Range</b>	0: Do not allow to read inverter parameters and save to the keypad 1: Allow to read inverter parameters and save to the keypad

LCD digital operator with built-in memory (EEPROM) can be used to store and retrieve parameters:

- (1) Read: Save inverter parameters to the digital operator (INV → OP).
- (2) Write: Write the parameters from the digital operator to the inverter and save (OP → INV).
- (3) Verify: Compare the inverter parameters against the parameters in the digital operator.

**16-07=0:** No action

**16-07=1:** Read (all parameters are copied from the inverter to the keypad).

**16-07=2:** Write (all parameter are copied from the keypad to the inverter).

**16-07=3:** Verify (Compare the set value of the inverter to the parameter of the digital operator).

Set 16-08 = 0, to prevent the saved parameter data stored in the digital operator from accidentally being overwritten.

When parameter 16-08=0 and the read operation is executed (16-07=1) a warning message of "RDP Read Prohibited" will be displayed on the keypad and the read operation is cancelled.

Refer to the following steps for copy function operation.

For the write-in operation requires the following items to match.

- (1) Inverter type
- (2) Inverter rated capacity and voltage

**Note:**

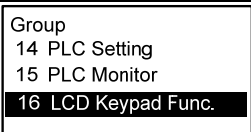
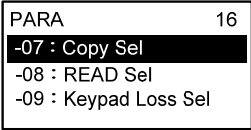
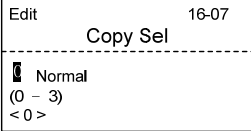
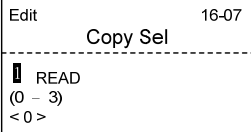
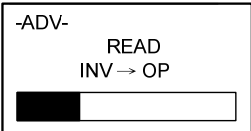
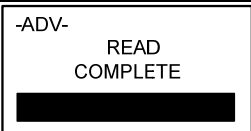
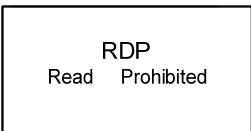
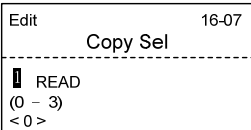

1. Inverter in V1.20 version or the above will support the data in older version written in newer version. If the version switch is completed, the power supply is restarted.
2. Data copy is not limited by parameter 00-00 (control mode selection) in the inverter in V1.20 version or the above.

■ **READ: Copy inverter parameters to the keypad**



Steps	Keypad (English)	Description
1		Select the copy function group (16) from the group menu.
2		Press the Read / Enter key and select parameter (16-07) copy sel.
3		Press the Read / Enter key to display the data setting / read screen (LCD display is inversed).
4		Change the set value to 1 (read) by using the up arrow key.
5		<ul style="list-style-type: none"> <li>• Use Read / Enter key to enable the read operation, the display is shown as the left.</li> <li>• The bottom of LCD display will show a bar to indicate the read progress.</li> </ul>
6		"READ COMPLETE" will be displayed on the keypad when reading was successful.
		<ul style="list-style-type: none"> <li>• The error message of "RDP Read Prohibited" may occur on the keypad when reading parameters from the inverter is prohibited.</li> <li>• If the error is displayed, press any key to remove the error message and go back to parameter 16-07.</li> </ul>
7		When DSP/FUN key is pressed, the display returns to parameter 16-07.

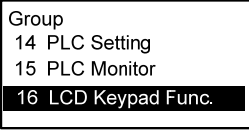
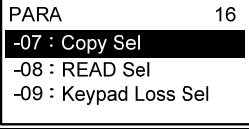
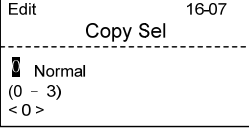
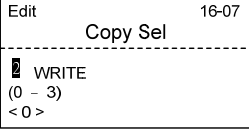
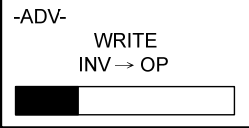

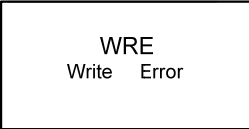
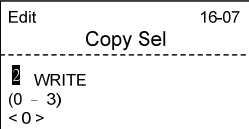
■ **WRITE: Copy Keypad parameters to the Inverter**

Steps	LCD Display (English)	Description
1		Select the copy function group (16) from the group menu.
2		Press the Read / Enter key and select parameter (16-07) copy sel.
3		Press the Read / Enter key to display the data setting / read screen (LCD display is inversed).
4		Change the set value to 2 (write) by using the up arrow key.
5		<ul style="list-style-type: none"> <li>• Use Read / Enter key to enable the read operation, the display is shown as the left.</li> <li>• The bottom of LCD display will show a bar to indicate the read progress.</li> </ul>
6		<p>“WRITE COMPLETE” will be displayed on the keypad when writing was successful.            . Until the subsequent display of "Syslnit", please power off and restart.</p>
		<ul style="list-style-type: none"> <li>• The error message of “WRE Write Error ” may occur on the keypad when writing parameters to the inverter is prohibited.</li> <li>• If the error is displayed, press any key to remove the error message and go back to parameter 16-07.</li> </ul>
7		When DSP/FUN key is pressed, the display returns to parameter 16-07.

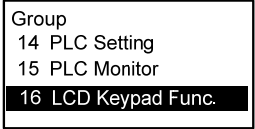
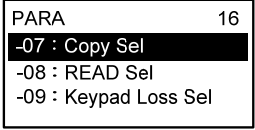
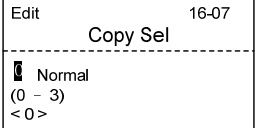
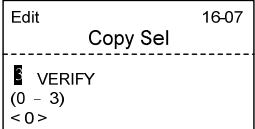
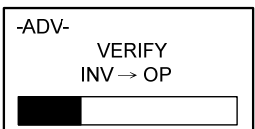
■ **Verify: Compare Inverter Parameters against Keypad Parameters**

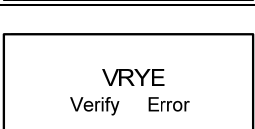
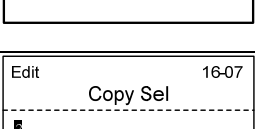
Steps	LCD Display (English)	Description
1		Select the copy function group (16) from the group menu.
2		Press the Read / Enter key and select parameter (16-07) copy sel.
3		Press the Read / Enter key to display the data setting / read screen (LCD display is inverted).
4		Change the set value to 3 (verify) by using the up arrow key.
5		<ul style="list-style-type: none"> <li>• Use Read / Enter key to enable the read operation, the display is shown as the left.</li> <li>• The bottom of LCD display will show a bar to indicate the read progress.</li> </ul>
6		"VERIFY COMPLETE" will be displayed on the keypad when writing was successful.
		<ul style="list-style-type: none"> <li>• The error message of "VRYE Verify Error " may occur on the keypad when writing parameters to the inverter is prohibited.</li> <li>• If the error is displayed, press any key to remove the error message and go back to parameter 16-07.</li> </ul>
7		When DSP/FUN key is pressed, the display returns to parameter 16-07.

16-09	Selection of keypad removed (LCD)
Range	<b>0:</b> Keep operating when LCD keypad is removed. <b>1:</b> Display fault when LCD keypad is removed.

**16-09=0:** Continue operating when keypad is removed.

**16-09=1:** Trip inverter when keypad is removed while operating in local mode.

<b>16- 10</b>	<b>RTC Time Display Setting</b>
<b>Range</b>	<b>【0】 : Hide</b> <b>【1】 : Display</b>
<b>16- 11</b>	<b>RTC Date Setting</b>
<b>Range</b>	<b>【12.01.01 ~ 99.12.31】</b>
<b>16- 12</b>	<b>RTC Time Setting</b>
<b>Range</b>	<b>【00:00 ~ 23:59】</b>

Set the internal clock before using the function of Real Time Clock (RTC).

RTC date setting is determined by parameter 16-11 and RTC time setting is determined by parameter 16-12.

RTC is displayed in the top of the keypad and refer to Fig.4.4.85 for the selection of RTC time display (16-10) is set to 1.

Monitor	00:00
Freq Ref	12-16 = 000.00 Hz
	12-17 = 000.00 Hz
	12-18 = 0000.0A

**Figure 4.4.85 RTC Time Display (Example)**

**Notes:**

- RTC is not enabled if keypad does not connect with the inverter.
- The counting time continues running regardless of the function being hide or display in the parameter 16-10 (RTC Time Display Setting).

Users can apply the parameters 12-72 and 12-73 to monitor the specific RTC date and time.

RTC has the following characteristics:

- Four times a day
- Four weeks
- Timer offset function (preset time)
- Timer enables via multi-function digital input
- Selection for constant time and speed
- Timer enables multi-function digital output

16- 13	RTC Timer Function
Range	<b>【0】</b> : Disable <b>【1】</b> : Enable <b>【2】</b> : Set by DI
16- 14	P1 Start Time
16- 15	P1 Stop Time
16- 18	P2 Start Time
16- 19	P2 Stop Time
16- 22	P3 Start Time
16- 23	P3 Stop Time
16- 26	P4 Start Time
16- 27	P4 Stop Time
Range	<b>【00:00 ~ 23:59】</b>
16- 16	P1 Start Date
16- 17	P1 Stop Date
16-20	P2 Start Date
16- 21	P2 Stop Date
16- 24	P3 Start Date
16- 25	P3 Stop Date
16- 28	P4 Start Date
16- 29	P4 Stop Date
Range	<b>【1】</b> : Mon <b>【2】</b> : Tue <b>【3】</b> : Wed <b>【4】</b> : Thu <b>【5】</b> : Fri <b>【6】</b> : Sat <b>【7】</b> : Sun
16- 30	Selection of RTC Offset
Range	<b>【0】</b> : Disable <b>【1】</b> : Enable <b>【2】</b> : Set by DI
16- 31	RTC Offset Time Setting
Range	<b>【00:00 ~ 23:59】</b>
16- 32	Source of Timer 1
16- 33	Source of Timer 2
16- 34	Source of Timer 3
16- 35	Source of Timer 4
Range	<b>【0~31】</b> : Refer to Table 4.4.13
16- 36	Selection of RTC Speed
Range	<b>【0】</b> : Off <b>【1】</b> : By Timer 1 <b>【2】</b> : By Timer 2 <b>【3】</b> : By Timer 3

	<b>【4】 : By Timer 4</b> <b>【5】 : By Timer 1+2</b>
<b>16- 37</b>	<b>Selection of RTC Rotation Direction</b>
<b>Range</b>	<b>【xxx0 B】 : RTC Run1 Forward Rotation</b> <b>【xxx1 B】 : RTC Run1 Reverse Rotation</b> <b>【xx0x B】 : RTC Run2 Forward Rotation</b> <b>【xx1x B】 : RTC Run2 Reverse Rotation</b> <b>【x0xx B】 : RTC Run3 Forward Rotation</b> <b>【x1xx B】 : RTC Run3 Reverse Rotation</b> <b>【0xxx B】 : RTC Run4 Forward Rotation</b> <b>【1xxx B】 : RTC Run4 Reverse Rotation</b>

Source of timer can be selected to link multiple time periods and one time period can be set to multiple timers.

Timer is set by the following steps:

① **Start the timer:**

Timer starts via the setting of RTC timer function (16-13).

② **Set the time period:**

Set the start & stop time and date. If the setting of start time is equal to that of stop time, timing period is off.

③ **The timer is enabled:**

Arrange time period to the specific timer (16-32~16-35).

④ **Link to parameters:**

The timer can be linked to the relay output. One relay output can be only linked to one timer( ex. 03-11, 03-12 and 03-39, 16-36).

**Note:** If the stop time is set to 12:00, Motor start to stop from 12:01.

Refer to Fig.4.4.86 for RTC structure.

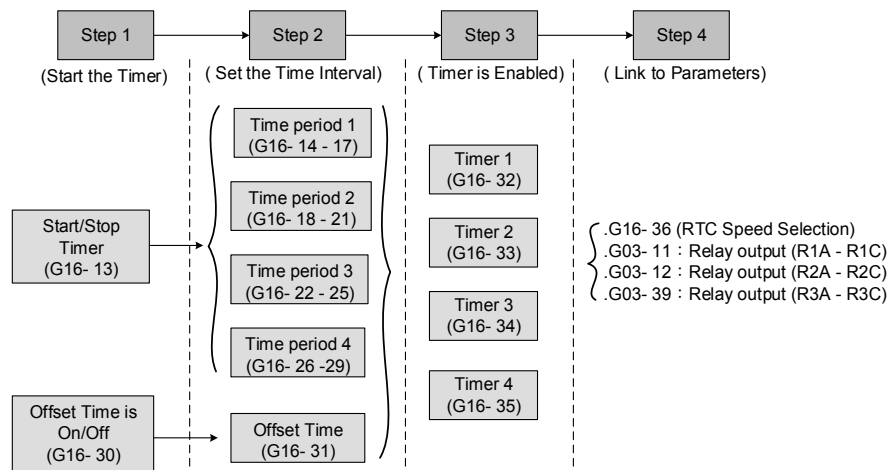

**Figure 4.4.86 RTC structure**

Refer to the following Table 4.4.13 for the selection of timer operation cycle.

**Table 4.4.13 Arrange time period to the timer function**

16-32 ~ 16-35	O	P4	P3	P2	P1	Timer Function	Display
0	0	0	0	0	0	Without the selection of timer	None
1	0	0	0	0	1	Time Period 1	P1
2	0	0	0	1	0	Time Period 2	P2
3	0	0	0	1	1	Time Period 1 and 2	P1+P2
4	0	0	1	0	0	Time Period 3	P3
5	0	0	1	0	1	Time Period 1 and 3	P1+P3
6	0	0	1	1	0	Time Period 2 and 3	P2+P3
7	0	0	1	1	1	Time Period 1 , 2 and 3	P1+P2+P3
8	0	1	0	0	0	Time Period 4	P4
9	0	1	0	0	1	Time Period 1 and 4	P1+P4
10	0	1	0	1	0	Time Period 2 and 4	P2+P4
11	0	1	0	1	1	Time Period 1 , 2 and 4	P1+P2+P4
12	0	1	1	0	0	Time Period 3 and 4	P3+P4
13	0	1	1	0	1	Time Period 1 , 3 and 4	P1+P3+P4
14	0	1	1	1	0	Time Period 2 , 3 and 4	P2+P3+P4
15	0	1	1	1	1	Time Period 1 , 2 , 3 and 4	P1+P2+P3+P4
16	1	0	0	0	0	Offset selection	Offset (O)
17	1	0	0	0	1	Offset and time period 1	O+P1
18	1	0	0	1	0	Offset and time period 2	O+P2
19	1	0	0	1	1	Offset and time period 1 and 2	O+P1+P2
20	1	0	1	0	0	Offset and time period 3	O+P3
21	1	0	1	0	1	Offset and time period 1 and 3	O+P1+P3
22	1	0	1	1	0	Offset and time period 2 and 3	O+P2+P3
23	1	0	1	1	1	Offset and time period 1 , 2 and 3	O+P1+P2+P3
24	1	1	0	0	0	Offset and time period 4	O+P4
25	1	1	0	0	1	Offset and time period 1 and 4	O+P1+P4
26	1	1	0	1	0	Offset and time period 2 and 4	O+P2+P4
27	1	1	0	1	1	Offset and time period 1 , 2 and 4	O+P1+P2+P4
28	1	1	1	0	0	Offset and time period 3 and 4	O+P3+P4
29	1	1	1	0	1	Offset and time period 1 , 3 and 4	O+P1+P3+P4
30	1	1	1	1	0	Offset and time period 2 , 3 and 4	O+P2+P3+P4
31	1	1	1	1	1	Offset and time period 1 , 2 , 3 and 4	O+P1+P2+P3+P4

Reference frequency and motor rotation direction are controlled by RTC function.

**16-36=0:** RTC speed selection is disabled.

**16-36=1:** Timer 1 is enabled.

Reference frequency = Frequency Setting of Speed-Stage 0 (05-01)

**16-36=2:** Timer 2 is enabled.

Reference frequency = Frequency Setting of Speed-Stage 0 (05-01)

**16-36=3:** Timer 3 is enabled.

Reference frequency = Frequency Setting of Speed-Stage 0 (05-01)

**16-36=4:** Timer 4 is enabled.

Reference frequency = Frequency Setting of Speed-Stage 0 (05-01)

**16-36=5:** Timer 1 and 2 are enabled.

Reference frequency is enabled by the simultaneous operation of timer 1 and 2.

**Notes:**

- The inverter runs via the start of the specific timer without the influence of other timers.
- The selection of RTC speed setting (16-36) is affected by the action of time period 1 to 4 (P1~P4) which is corresponding to the selection of RTC rotation direction (16-37).

For example:

When the selection of RTC speed is set to 5 (by timer 1+2), source of run command (00-02) and source of frequency command (00-05) are required to set to RTC. Thus, reference frequency is controlled by RTC timer 1 and 2 and the inverter continues running.

Refer to Table 4.4.14 for the control of reference frequency.

**Note:** Selection of RTC Rotation Direction (16-37) is limited by the Motor Direction Lock Selection(11-00).

**Note:** The offset 16-37 running direction will select by the direction of the timer 1

**Table 4.4.14 Reference frequency is determined by timer 1 and 2**

Timer 1	Timer 2	Main Frequency Command Source Selection (00-05)	Source of frequency setting	Selection of rotation direction
0	0	6(RTC)	Set by frequency setting of speed-stage 0 (05-01)	By RTC 1 (16-37)
1	0	6(RTC)	Set by frequency setting of speed-stage 1 (05-02)	By RTC 2 (16-37)
0	1	6(RTC)	Set by frequency setting of speed-stage 2 (05-03)	By RTC 3 (16-37)
1	1	6(RTC)	Set by frequency setting of speed-stage 3 (05-04)	By RTC 4 (16-37)

RTC function can not run normally when:

- When multi-function terminal (03-00~03-05) is set to the fire mode.
- When KEB function is enabled
  - Source of main frequency of RTC function is according to Table 4.4.14 and also can refer to main and alternative frequency command modes (00-07).
  - If main run command source selection (00-02) is set to 0~3 (0: keypad, 1: external terminal, 2: communication control, 3: PLC), refer to Table 4.4.15 for the relationship between main run command and RTC timer status.

**Table 4.4.15 Relationship between main run command and RTC timer status**

Main run command 00-02	RTC timer x status	Inverter status
0~3	0	Inverter can not run (without run command)
0~3	1	Inverter can not run (without run command)
4	0	Inverter can not run (RTC timer is disabled)
4	1	Inverter runs and rotates depending on the function of 16-37.

Take an example for RTC timer connecting with different parameters:

The work time on Monday is 6:00 AM to 10:00 PM.

The work time on Tuesday to Friday is 8:00 AM to 8:00 PM.

The work time on Saturday is 8:00 AM to 6:00 PM.

The work time on Sunday is 8:00 AM to 12:00 PM.

Motor runs on weekdays (Mon. to Fri.) at speed 1 and on weekends at speed 2.

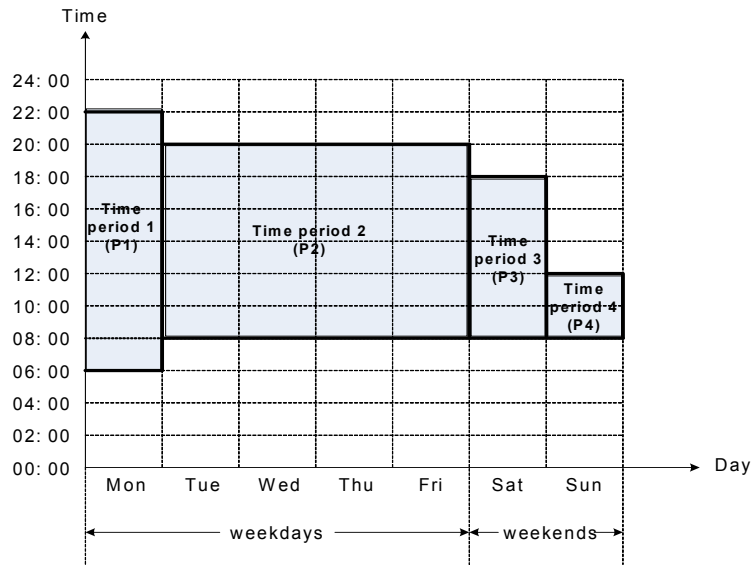

Figure 4.4.87 RTC timer (example)

- ① **Start up the timer in the parameter group 16** (Set the internal time first to enable this function).  
Set the correct date and time in the parameters 16-11 and 16-12 and set parameter 16-13 to 1(enable RTC timer function).
- ② **Set time period 1 (P1)**  
Start time 1: 16-14 = 06:00:00 (6:00 AM)  
Stop time 1: 16-15 = 22:00:00 (10:00 PM)  
Start date 1: 16-16 = 1 (Monday)  
Stop date 1: 16-17 = 1 (Monday)
- ③ **Set time period 2 (P2)**  
Start time 2: 16-18 = 08:00:00 (8:00 AM)  
Stop time 2: 16-19 = 20:00:00 (8:00 PM)  
Start date 2: 16-20 = 2 (Tuesday)  
Stop date 2: 16-21 = 5 (Friday)
- ④ **Set time period 3 (P3)**  
Start time 3: 16-22 = 08:00:00 (8:00 AM)  
Stop time 3: 16-23 = 18:00:00 (6:00 PM)  
Start date 3: 16-24 = 6 (Saturday)  
Stop date 3: 16-25 = 6 (Saturday)
- ⑤ **Set time period 4 (P4)**  
Start time 4: 16-26 = 08:00:00 (8:00 AM)  
Stop time 4: 16-27 = 12:00:00 (12:00 AM)  
Start date 4: 16-28 = 7 (Sunday)  
Stop date 4: 16-29 = 7 (Sunday)



⑥ **Timer 1 is enabled to set all the time periods (P1, P2, P3, P4)**

16-32 = 15: Source of timer 1 = P1 + P2 + P3 + P4)

⑦ **Selection of RTC speed is determined by timer 1**

16-36 = 1: Timer 1 is enabled.

Frequency setting is speed-stage 0 (05-01).

Rotation direction (16-37) is set to 0000b.

Then, the rotation direction of time period 1~4 (P1~P4) is corresponding to the setting of 16-37.

⑧ **Choose two constant speeds (speed 1 & speed 2)**

16-36 = 5: Timer 1+2 is enabled.

When timer 1 is enabled, frequency setting is speed-stage 1; while timer 2 is enabled, frequency setting is speed-stage 2.

Rotation direction (16-37) is set to 0000b.

Then, when timer 1 and timer 2 are active, direction of motor rotation is forward rotation.

**Note:** Select RTC offset (16-30) and set RTC offset time (16-31) to enable the offset time. Inverter runs depending on the arranging time period to timer function. Refer to the following Fig.4.4.88.

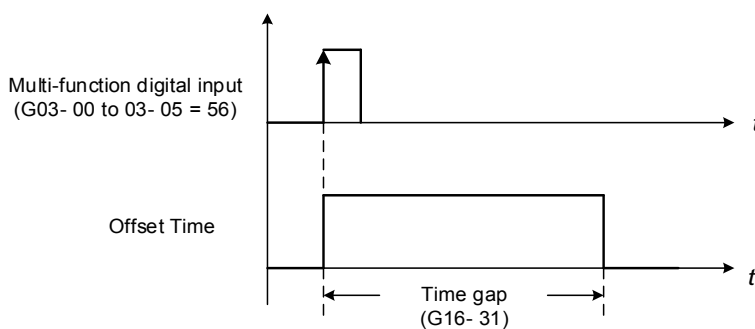

**Figure 4.4.88 Operation of offset time**

For example:

**Inverter runs at the time period exclusive P1:**

When 16-36=1 (selection of RTC speed is set to timer 1) and 16-32=17 (offset + P1), RTC offset (16-30) is set by DI and the offset time is set via 16-31. Switch on DI and RTC will immediately start up.

If the source of timer is set to 15 (P1+P2+P3+P4), press “STOP” key at the time period 1 (P1). Normally, RTC will start automatically at the next time period (P2) but it can also start via the setting of 16-30 to 2 (set by DI). Inverter re-runs when switching on DI and RTC will immediately start up.

**Notes:**

If press “STOP” key at the time period and inverter can re-run at this time, user can:

- Set the selection of RTC offset (16-30) to 2 (set by DI) and set DI to 56 (RTC Offset Enable).
- Switch the selection of RTC offset (16-30) to be enabled.

**Note:**

RTC Accuracy:

Temperature	Deviation
+25°C(77°F)	+/-3 sec./ day
-20 / +50 °C (-4/ 122°F)	+/-6 sec./ day

### 17-Automatic Tuning Parameters

<b>17-00</b>	<b>Mode selection of automatic tuning</b>
<b>Range</b>	<b>0:</b> Rotational auto-tuning <b>1:</b> Static auto-tuning <b>2:</b> Stator resistance measurement <b>3:</b> Reserved <b>4:</b> Loop tuning <b>5:</b> Rotational Auto-tuning Combination (Item: 4+2+0) <b>6:</b> Static Auto-tuning Combination (Item: 4+2+1)

<b>17-01</b>	<b>Motor rated output power</b>
<b>Range</b>	0.00~600.00 kW

<b>17-02</b>	<b>Motor rated current</b>
<b>Range</b>	For VF, VF+PG modes, 10%~200% of the inverter rated current For SLV, SV modes, 25%~200% of the inverter rated current.

<b>17-03</b>	<b>Motor rated voltage</b>
<b>Range</b>	200V: 50.0~240.0 V 400V: 100.0~480.0 V 575V: 150.0~670.0 V 690V: 180.0~804.0 V

<b>17-04</b>	<b>Motor rated frequency</b>
<b>Range</b>	4.8~599.0 Hz

<b>17-05</b>	<b>Motor rated speed</b>
<b>Range</b>	0~24000 rpm

<b>17-06</b>	<b>Pole number of motor</b>
<b>Range</b>	2~16 pole

<b>17-07</b>	<b>Number of PG pulse</b>
<b>Range</b>	0~60000 PPR

If auto tune is not executed, or not completed successfully, value of 17-07 will be overwritten by 20-27 automatically

If auto tune is done successfully, 20-27 will be overwritten by 17-07.

<b>17-08</b>	<b>Motor no-load voltage</b>
<b>Range</b>	200V: 50~240 V 400V: 100~480 V 575V: 420~600 V 690V: 504~720 V

<b>17-09</b>	<b>Motor excitation current</b>
<b>Range</b>	15~70% motor rated current

<b>17-10</b>	<b>Automatic tuning start</b>
<b>Range</b>	<b>0:</b> Disable <b>1:</b> Enable

<b>17-11</b>	<b>Error history of automatic tuning</b>
<b>Range</b>	<b>0:</b> No error <b>1:</b> Motor data error <b>2:</b> Stator resistance tuning error <b>3:</b> Leakage induction tuning error <b>4:</b> Rotor resistance tuning error <b>5:</b> Mutual induction tuning error <b>6:</b> Encoder error <b>7:</b> DT Error <b>8:</b> Motor's acceleration error <b>9:</b> Warning

**Notes:**

- Values are for 200V class, double the values for 400V class.
- In HD mode (00-27=0) the range is 0.0 to 400.0 Hz, 0.0 to 120.0Hz in for ND mode (00-27=1) and 0.0 to 599.0Hz is high frequency mode.

**Auto-tuning**

Based on the motor nameplate set the motor rated output power (17-01), motor output rated current (17-02), motor rated voltage (17-03), motor rated frequency (17-04), motor rated speed (17-05) and number of motor poles (17-06) to perform an auto-tune.

■ Automatic tuning mode selection (17-00)

Rotational auto-tuning (17-00=0) provide higher quality for motors.

After executing Rotational auto-tuning (17-00), Excitation current of motor 1 (02-09)、Core saturation coefficient 1 of motor 1(02-10)、Core saturation coefficient 2 of motor 1 and Core saturation coefficient 3 of motor 1 (02-12) will renew the value.

Static auto-tuning (17-00=1) won't rotate the motor while auto-tuning.

After executing Static auto-tuning (17-00=1), Proportion of motor leakage inductance (02-33) and Motor slip (02-34) will renew the value.

Stator resistance measurement (17-00=2) provide for long motor leads

After executing Stator resistance measurement (17-00=2), Resistance between wires of motor 1(02-15) will renew the value.

Loop tuning (17-00=4) provide great response of current circuit, it can improve frequency bandwidth of current and torque.

Rotation Auto-tuning Combination (17-00=5) is the auto-tuning for three in one, including Loop tuning (17-00=4)、Stator resistance measurement (17-00=2) and Rotational auto-tuning (17-00=0).

Static Auto-tune Combination (17-00=6) is the auto-tuning for three in one, including Loop tuning (17-00=4)、Stator resistance measurement (17-00=2) and Static auto-tuning (17-00=1)

- Motor rated output power (17-01)  
Set by inverter capacity (13-00)
- Motor rated current (17-02)  
Set by inverter capacity (13-00)  
Set the range to 10 %~120 % of the inverter rated current.

- Motor rated voltage (17-03)
- Motor rated frequency (17-04)
- Motor rated speed (17-05)

When tuning a special motor (e.g. constant power motor, high-speed spindle motor), with a motor rated voltage or rated motor frequency that is lower than a standard AC motor, it is necessary to confirm the motor nameplate information or the motor test report.

Prevent the inverter output voltage from saturation when the motor rated voltage is higher than the inverter input voltage (see Example 1).

**Example 1:** Motor rated voltage (440V/60Hz) is higher than the inverter input voltage (380V/50 Hz).

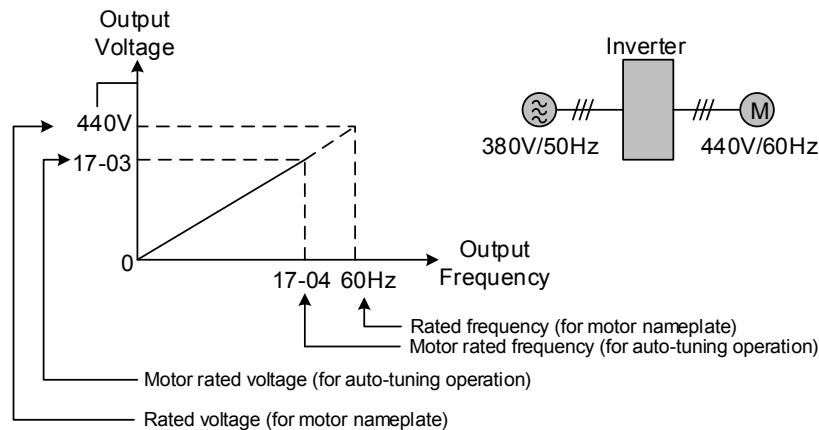

**Figure 4.4.104 Rated voltage and frequency settings**

- Step 1: Set auto-tuning (17-00), and set motor rated output power (17-01) and the motor rated current (17-02) by label of the motor.
- Step 2: Set the value of motor rated voltage (17-03) =440V by label of the motor.
- Step 3: Set the value of motor rated frequency (17-04) =60Hz
- Step 4: Set the value of motor rated speed (17-05) 、 pole number of motor (17-06) and PG pulse number (17-07). Beware that PG pulse number (17-07) only used in SV and V/F+PG mode.
- Step 5: Set the value of motor no-load voltage (17-08) =360V, the set value for torque control is 20V lower than input voltage.
- Step6: Execute auto-tuning. Set auto-tuning (17-10=1) and enter to standby screen. Enter RUN command to start auto-tuning. The value of selection of PG rotation direction (20-28) adjusts automatically with PG card when auto-tuning. The value of motor rated frequency (17-04) adjusts automatically to the same as the value of base frequency of motor 1.If the value of maximum output frequency of motor 1(01-02) is different form base frequency of motor 1 (01-12), the system will adjust the value of maximum output frequency of motor 1(01-02) the same as base frequency of motor 1 (01-12) automatically.

When the inverter input voltage (or frequency) is higher than the motor rated voltage (or frequency), set the motor rated voltage (17-03) and the motor rated frequency (17-04) to the rated frequency on the motor nameplate.

**Example 2:** The inverter input voltage and frequency (460V/50Hz) are higher than the motor rated voltage and frequency (380V/33Hz), set 17-03 to 380V (rated motor voltage) and 17-04 to 33Hz (motor rated frequency).

- Number of poles (17-06)  
Set the motor pole number with its range is 2, 4, 6 and 8 poles

- Number of PG pulse (17-07)  
Set the pulse number of each cycle. If the control mode is SV mode and the V / F + PG mode, the encoder must be installed on the motor shaft and there is no reduction gear ratio.
- Motor no-load voltage (17-08)
  - a) Motor no-load voltage is mainly used in SV or SLV mode, set to value 10~50V lower than the input voltage to ensure good torque performance at the motor rated frequency.
  - b) Set to 85 ~ 95% of the motor rated voltage. In general, the no-load voltage can be closer to the motor rated voltage for larger motors, but cannot exceed the motor rated voltage.
  - c) The motor no-load voltage can be set to a value greater than the actual input voltage. In this case, the motor can only operate under relatively low frequency. If the motor operates at the rated frequency an over voltage condition may occur.
  - d) The higher the motor power is, the higher the no-load voltage is.
  - e) A smaller no-load voltage will reduce the no-load current.
  - f) When load is applied the magnetic flux is weakened and the motor current increases.
  - g) A higher no-load voltage results in a higher the no-load current.
  - h) When load is applied the magnetic flux weakens and the motor current increases. Increasing the magnetic flux generates back EMF and results in poor torque control.
- Motor excitation current (17-09)
  - a) Motor excitation current is used for rotational auto-tune.
  - b) Set motor excitation current to 33% of the motor rated current. Refer to parameter 02-09 for test running.
  - c) Only the static-type or stator resistance measurement auto-tune (17-00=1 or 1700=2) can be set.
  - d) It is required to refer to the monitoring parameter 12-76 for adjusting the motor excitation current (17-09).  
When the excitation current change, parameter 12-76 is also affected so it should be adjusted to the setting no-load voltage (17-08).
- Automatic tuning start (17-10)  
Set parameter 17-10 to 1 and press ENTER the inverter will display "Atrdy" for Auto-tune ready. Next press RUN to start the auto-tune procedure. During auto-tune the keypad will display "Atune" for Auto-tune in progress. When the motor is successfully tuned, the keypad shows "AtEnd".
- Error history of automatic tuning (17-11)  
If auto-tuning fails the keypad will display the "AtErr" message and the auto-tune cause is shown in parameter 17-11. Refer to section 5 for troubleshooting and possible automatic tuning error causes.

**Note:** The motor tuning error history (17-11) shows the tuning result of the last auto-tune. No error is displayed when auto-tune is aborted or when the last auto-tune was successful.

Perform the "Stator resistance measurement" (17-00=2) auto-tune if the inverter/motor leads are longer than 167ft (50m).

For the best performance in vector control perform the rotary-type automatic tune (17-00 = 0) first (using short motor leads between the inverter and motor) and a "Stator resistance measurement" (17-00=2) next.

If a rotary auto-tune (17-00=0) cannot be performed, manually enter the mutual induction (02-18), excitation current (02-09), core saturation compensation factor 1-3 (02-11 - 02-13).

Perform the "Stator resistance measurement" (17-00=2) in V/F control when inverter/motor leads are longer than 167ft (50m).

<b>17-12</b>	<b>Proportion of Motor Leakage Inductance</b>
<b>Range</b>	0.1~15.0 %

Only the stator resistance auto tune (17-00=2) can be set.

The static non-rotational type and rotational type auto tune will automatically measure the proportion of motor leakage inductance so this parameter is not active.

It is set the value to 4%. Refer to parameter 02-33 for test run to adjust.

<b>17-13</b>	<b>Motor Slip Frequency</b>
<b>Range</b>	0.10~20.00 Hz

Only the stator resistance auto tune (17-00=2) can be set.

The static non-rotational type and rotational type auto tune will automatically measure the proportion of motor leakage inductance so this parameter is not active.

Refer to parameter 02-34 for counting the setting value.

<b>17-14</b>	<b>Rotational Auto-tuning</b>
<b>Range</b>	<b>【0】</b> : VF type rotational auto-tuning <b>【1】</b> : Vector type rotational auto-tuning

It can be set (17-14) only if Rotational auto-tuning (17-00=0) or Rotational Auto-tuning Combination (17-00=5). VF type rotational auto-tuning (17-14=0) applies the standard IM motor that won't shake without loading for V/F mode. This function is highly applicable,

Vector type rotational auto-tuning (17-14=1) applies the special IM motor that will shake without loading for V/F mode. This function applies for high speed motor. Vector type rotational auto-tuning (17-14=1) measures no-loading current of motor by inner current vector method. It avoid the problem appears oscillating current easily in V/F mode.

If execute VF type rotational auto-tuning (17-14=0) unsuccessfully, try Vector type rotational auto-tuning (17-14=1) again.

### 18-Slip Compensation Parameters

<b>18-00</b>	<b>Slip compensation gain at low speed</b>
<b>Range</b>	0.00~2.50
<b>18-01</b>	<b>Slip compensation gain at high speed</b>
<b>Range</b>	-1.00~1.00
<b>18-02</b>	<b>Slip compensation limit</b>
<b>Range</b>	0~250%
<b>18-03</b>	<b>Slip compensation filter</b>
<b>Range</b>	0.0~10.0 Sec
<b>18-04</b>	<b>Regenerating slip compensation selection</b>
<b>Range</b>	0: Disable 1: Enable
<b>18-05</b>	<b>FOC delay time</b>
<b>Range</b>	1~1000 msec
<b>18-06</b>	<b>FOC gain</b>
<b>Range</b>	0.00~2.00

Slip compensation automatically adjusts the output frequency based on the motor load to improve the speed accuracy of the motor mainly in V/F mode.

The slip compensation function compensates for the motor slip to match the actual motor speed to the reference frequency.

#### Slip compensation adjustment in V/F mode

##### 18-00: Slip compensation gain at low speed

The adjustment of slip compensation gain at low speed follows the below procedure:

1. Set the rated slip and the motor no-load current (02-00).
2. Set the slip compensation (18-00) to 1.0 (factory default setting is 0.0 in V / F control mode)
3. For the operation with a load attached, measure the speed and adjust the slip gain (18-00) accordingly (increase in steps of 0.1).
  - If the motor speed is lower than frequency reference, increase the value of 18-00.
  - If the motor speed is higher than frequency reference, decrease the value of 18-00.

When the output current is greater than the no-load current (02-00), the slip compensation is enabled and the output frequency increases from  $f_1$  to  $f_2$ . Refer to Figure 4.4.100., the slip compensation value is calculated as follows:

$$\text{Slip Compensation Value} = \text{Motor rated slip frequency} \times \frac{[\text{Output current (12-18)} - \text{no-load current of Motor 1 (02-00)}]}{[\text{Rated current of Motor 1(02-01)} - \text{no-load current of Motor 1 (02-00)}]}$$

$$\text{Motor Rated Slip Frequency (f)} = \frac{(\text{Motor no-load synchronous speed} - \text{Motor full load rated speed})(N) \times \text{Motor Poles (P)}}{120}$$

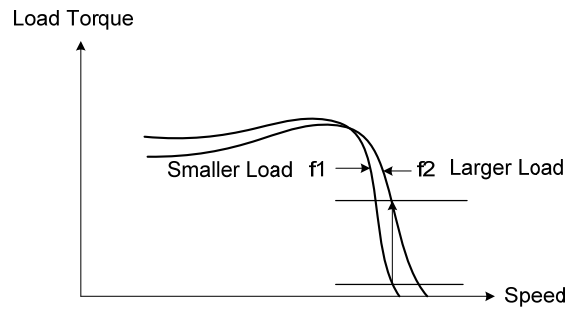

**Figure 4.4.105 Slip compensation output frequency**

**18-02: Slip compensation limit**

Sets slip compensation limit in constant torque and the constant power operation (figure 4.4.106). If 18-02 is 0%, the slip compensation limit is disabled.

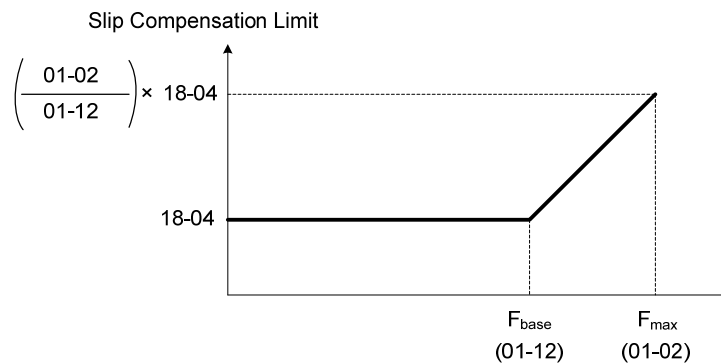

**Figure 4.4.106 Slip compensation limit**

When the slip compensation gain 18-00 at low speed is adjusted, and the actual motor speed is still lower than the reference frequency, the motor may be limited by the slip compensation limit.

**Note:** Make sure that the slip compensation limit 18-02 does not exceed the maximum allowed system limit.

**18-03: Slip compensation filter**

Set slip compensation filter time in V/F mode

**18-04: Regenerating slip compensation selection**

The selections to enable or disable the slip compensation function during regeneration.

To enable slip compensation during regeneration caused by deceleration (SLV mode), set 18-04 to 1 in case speed accuracy is required. When the slip compensation function is used regenerative energy might increase temporarily (18-04= 1) therefore a braking module might be required.



## SLV mode adjustment

### 18-00: Slip compensation gain

- Slip compensation can be used to control the full range speed accuracy under load condition.
- If the speed is lower than 2 Hz and the motor speed decreases, increase the value of 18-00.
- If the speed is lower than 2 Hz and the motor speed increases, reduce the value of 18-00.

Slip compensation gain uses a single value for the whole speed range. As a result the slip compensation accuracy at low speed is high but slight inaccuracies might occur at high speeds.

Adjust parameter 18-02 together with the compensation value or continue to adjust 18-00 if the speed accuracy at higher speed is not acceptable. Please note adjusting these parameters might impact the accuracy at lower speeds.

The impact of 18-00 on the torque and the speed are shown in figure 4.4.107.

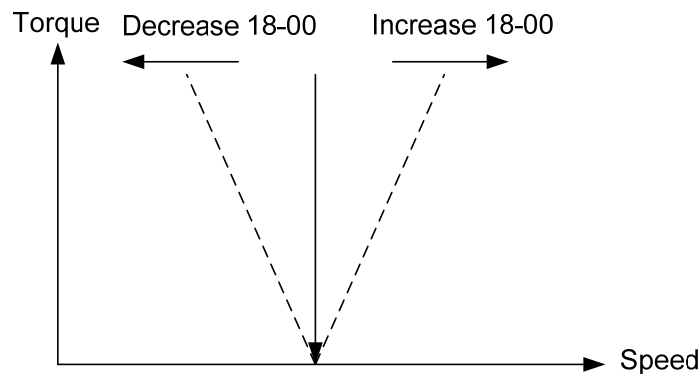

Figure 4.4.107 18-00 Effect on the torque and speed

### 18-01: Slip compensation gain at high speed

It is not required to adjust the Slip compensation gain at high speed if the motor is loaded. After adjusting parameter 18-00 it is recommended to increase the reference frequency and check the motor speed. In case of a speed error increase the value of 18-01 to adjust the compensation. Increase the motor rated frequency (01-12 base frequency) and increase the value of 18-01 to reduce the speed error. If the speed accuracy becomes worse due to an increase in motor temperature it is recommended to use a combination of 18-00 and 18-01 for adjustment.

Compared to 18-00, 18-01 serves as a variable gain for the full speed range. Parameter 18-01 determines the slip compensation at the motor rated speed and is calculated follows:

$$\text{Slip Compensation Gain} = (\text{Slip Compensation Gain at low speed} + \text{Slip Compensation Gain at high speed}) \times \frac{\text{Reference Frequency}}{\text{Motor rated frequency (01-12)}}$$

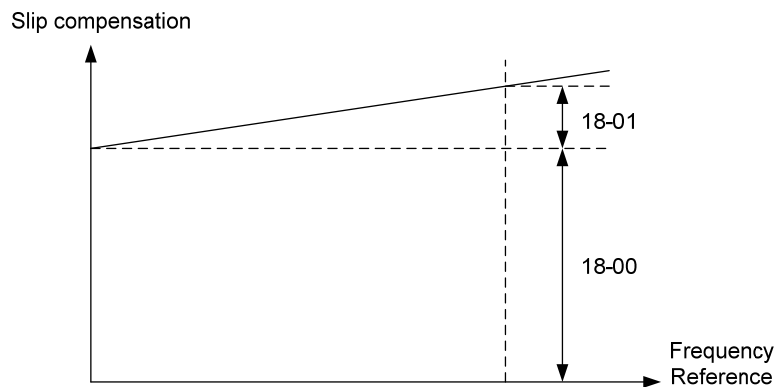

**Figure 4.4.108 18-00/18-01 Slip compensation gain versus frequency reference**

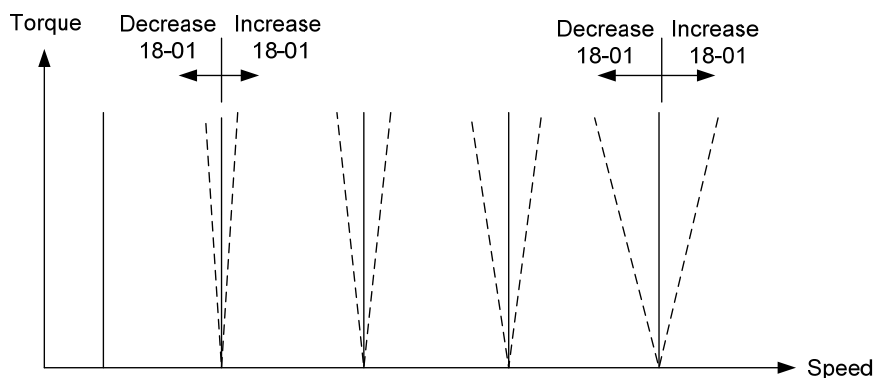

**Figure 4.4.109 18-01 Effect on torque speed curve**

**18-05:** FOC (Flux Orient Control) delay time

In the SLV mode, the slip compensation of the magnetic flux depends on the torque current and excitation current. If the motor load rises above 100% while running at the motor rated frequency, the motor voltage and resistance drops sharply, which may cause the inverter output to saturate and current jitter occur. The magnetic flux slip compensation will independently control the torque current and the excitation current to prevent current jitter. For slow speed or fixed speed operation, 18-05 may be increased. For fast operation adjust 18-06.

**18-06:** Slip compensation gain

If the motor is jittering at the rated frequency under full load, the value of 18-06 may gradually be reduced to zero to reduce current jitter.

**SLV2 mode adjustment**

Default value of parameter 18-00 is 0.0. ( when 18-00 = 0.0, slip compensation function is off.)

Adjustment of slip compensation gain (18-00) is the following:

- a) Correctly set the rated slip and no-load current (02-00).
- b) Set slip compensation gain (18-00).
- c) Run under load. Measure the speed and adjust slip compensation gain (18-00) with the unit of 0.1.

**Notes:**

- If the motor speed is lower than the target speed, increase the setting value of low-speed slip compensation gain (18-00).
- If the motor speed is higher than the target speed, reduce the setting value of low-speed slip compensation gain (18-00).

19–Wobble Frequency Parameters	
<b>19-00</b>	<b>Center frequency of wobble frequency</b>
<b>Range</b>	5.00~100.00%
<b>19-01</b>	<b>Amplitude of wobble frequency</b>
<b>Range</b>	0.1~20.0%
<b>19-03</b>	<b>Jump time of wobble frequency</b>
<b>Range</b>	0~50 msec
<b>19-04</b>	<b>Wobble frequency cycle time</b>
<b>Range</b>	0.0~1000.0 Sec
<b>19-05</b>	<b>Wobble frequency ratio</b>
<b>Range</b>	0.1~10.0 msec
<b>19-06</b>	<b>Upper offset amplitude of wobble frequency</b>
<b>Range</b>	0.0~20.0 %
<b>19-07</b>	<b>Lower offset amplitude of wobble frequency</b>
<b>Range</b>	0.0~20.0 %

Wobble operation can be used in V/F and V/F+PG control mode to modulate the output frequency around the reference frequency for use in winding application to create an evenly wound roll.

Refer to the figure 4.4.110 for the wobble operation and the related parameter settings.

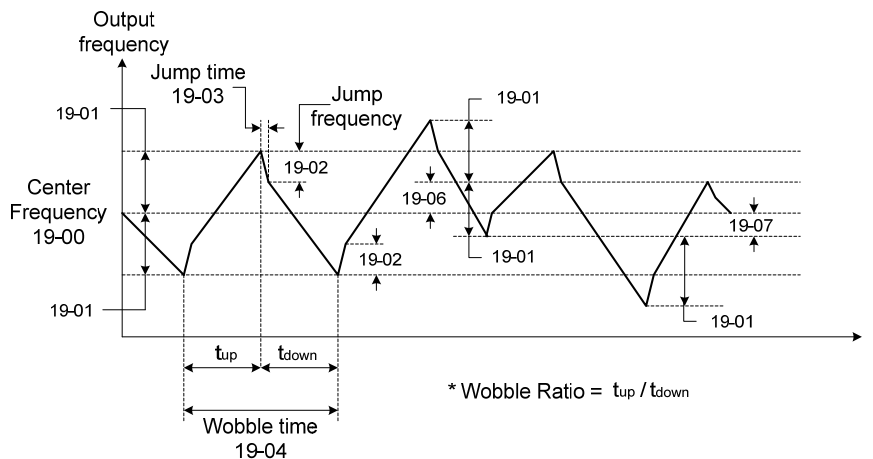

**Figure 4.4.110 Wobble operation and the related parameter setting**

In wobble operation, one of multifunction digital inputs (03-00 to 03-07) is set to 37 (wobble operation) and the run command is active. When the wobble operation is ready, the inverter output frequency reaches the center frequency (19-00). The acceleration time to the center frequency is the original pre-set acceleration time (Tacc 1 to Tacc 4). When the wobble operation is closed or the run command is removed, the deceleration time used is the original pre-set deceleration time (Tdec 1 to Tdec4).

In wobble operation, the inverter operates uses the in the wobble time (19-04,  $t_{up} + t_{down}$ ) and wobble frequency (19-05,  $t_{up} / t_{down}$ ).

Set multi-function digital output terminals (R1A-R1C, R2A-R2C) to output wobble operation (in acceleration) by setting from 03-11 to 03-12 to 20 or 21.

Refer to the figure 4.4.111 for the wobble ON / OFF control.

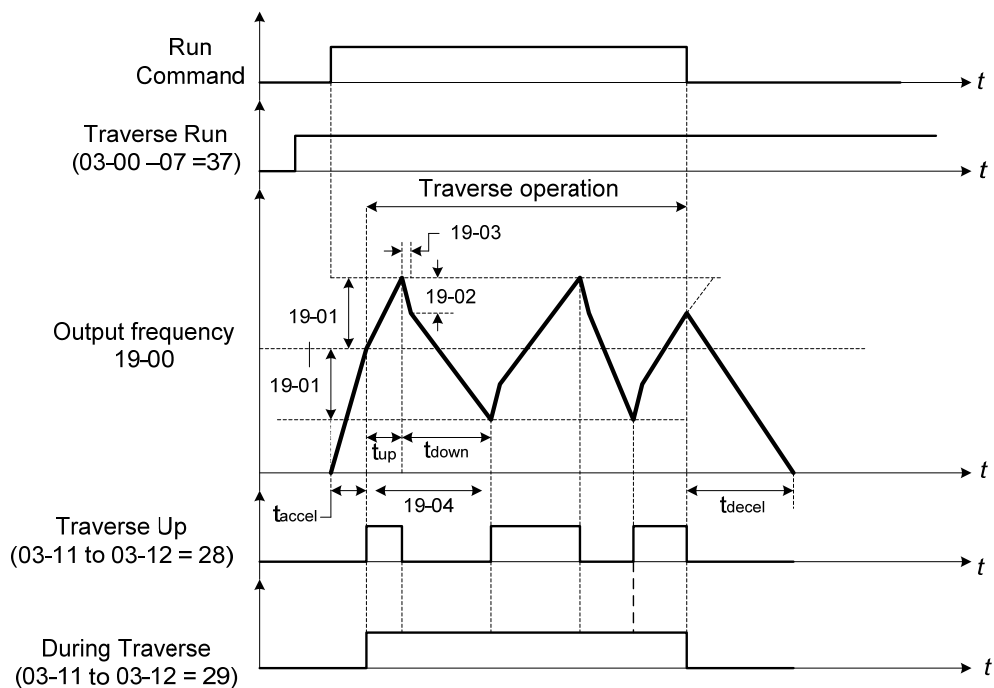

**Figure 4.4.111 ON/OFF control of wobble**

In wobble operation, the center frequency can be controlled by one of multi-function digital inputs.

The wobble upper and lower deviation command (03-00 to 07 = 38) and the wobble lower deviation command (03-00 to 07 = 39) cannot be active at the same time, this will result in the inverter operating at the original center frequency (19 - 00). Refer to Figure 4.4.112.

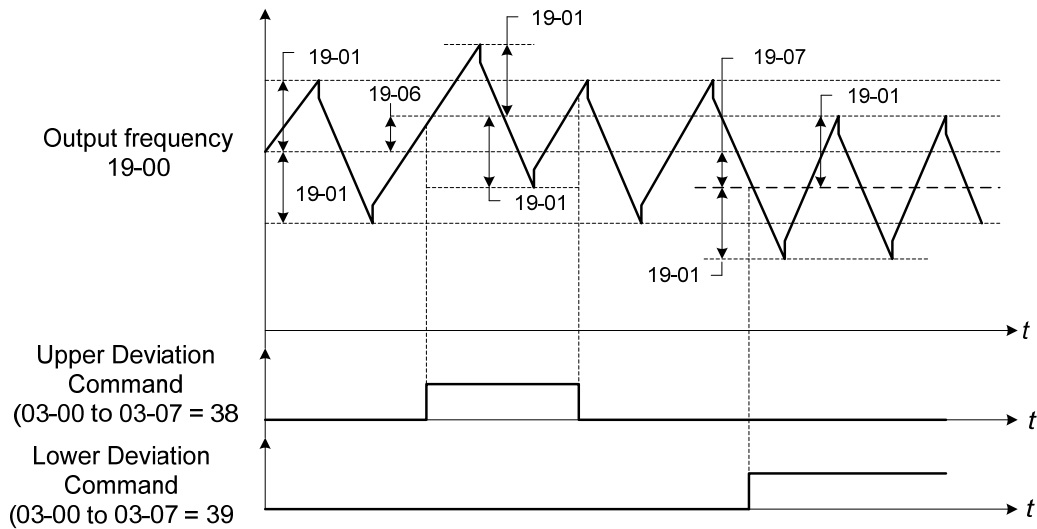

**Figure 4.4.112 Upper/Lower offset operation**

The wobble operation can be used during acceleration and deceleration when the stall prevention function is idle.

Select the appropriate inverter size to match the system requirement.

The wobble operation frequency range is determined by the upper limit and lower limit of the inverter frequency. If (center frequency + amplitude) is greater than the upper frequency limit, the output frequency is limited to the upper frequency limit; if (center frequency - Amplitude) is less than the lower frequency limit the output frequency is limited to the lower frequency limit.

### 20-Speed Control Parameters

<b>20-00</b>	<b>ASR gain 1</b>
<b>Range</b>	0.00~250.00
<b>20-01</b>	<b>ASR integral time 1</b>
<b>Range</b>	0.001~10.000 Sec
<b>20-02</b>	<b>ASR gain 2</b>
<b>Range</b>	0.00~250.00
<b>20-03</b>	<b>ASR integral time 2</b>
<b>Range</b>	0.001~10.000 Sec
<b>20-04</b>	<b>ASR integral time limit</b>
<b>Range</b>	0~300 %
<b>20-05</b>	<b>ASR positive limit</b>
<b>Range</b>	0.1 ~ 10 %
<b>20-06</b>	<b>ASR negative limit</b>
<b>Range</b>	0.1 ~ 10 %
<b>20-07</b>	<b>Selection of acceleration and deceleration of P/PI</b>
<b>Range</b>	<p><b>0:</b> PI speed control will be enabled only in constant speed. For the speed acceleration and deceleration, only use P control.</p> <p><b>1:</b> Speed control is enabled either in acceleration or deceleration.</p>
<b>20-08</b>	<b>ASR delay time</b>
<b>Range</b>	0.000~0.500 Sec
<b>20-09</b>	<b>Speed Observer Proportional(P) Gain1</b>
<b>Range</b>	0.00~2.55
<b>20-10</b>	<b>Speed Observer Integral(I) Time 1</b>
<b>Range</b>	0.01~10.00 Sec
<b>20-11</b>	<b>Speed Observer Proportional(P) Gain2</b>
<b>Range</b>	0.00~2.55
<b>20-12</b>	<b>Speed Observer Integral(I) Time 2</b>
<b>Range</b>	0.01~10.00 Sec
<b>20-13</b>	<b>Low-pass filter Time constant of speed feedback 1</b>
<b>Range</b>	1~1000 msec
<b>20-14</b>	<b>Low-pass filter Time constant of speed feedback 2</b>
<b>Range</b>	1~1000 msec

<b>20-15</b>	<b>ASR gain change frequency 1</b>
<b>Range</b>	0.0~599.0 Hz
<b>20-16</b>	<b>ASR gain change frequency 2</b>
<b>Range</b>	0.0~599.0 Hz
<b>20-17</b>	<b>Torque compensation gain at low speed</b>
<b>Range</b>	0.00~2.50
<b>20-18</b>	<b>Torque compensation gain at high speed</b>
<b>Range</b>	-10~10%
<b>20-33</b>	<b>Detection Level at Constant Speed</b>
<b>Range</b>	0.1~5.0 %

Parameter 20-33 is used when 20-07 is set to 0 and frequency command source is set to analog input mode. Analog input signal, owing to the noise, will cause the system to determine the operation does not reach the constant speed so the problem may occur. Thus, adjust parameter 20-33 to avoid this situation occurring..

The following figure an overview of the automatic speed regulator (ASR) block.

**V/F + PG control mode:**

The ASR function adjusts the output frequency to control the motor speed to minimize the difference between the frequency reference and actual motor speed.

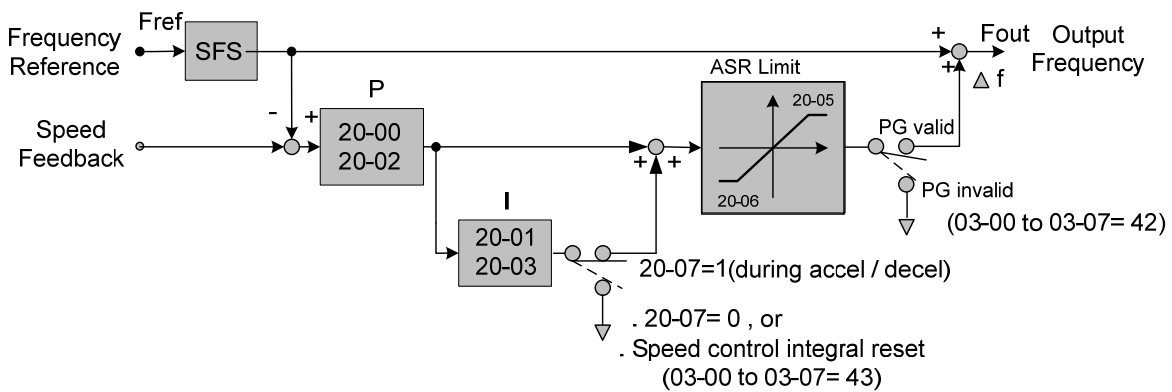

**Figure 4.4.113 ASR block diagram (V/F + PG)**

If one of the multi-function input (03-00 to 03-07) is set to 42 (PG is disabled), the input can be used to enable or disable the speed control loop system (ASR).

**SLV control mode:**

The ASR function adjusts the output frequency to control the motor speed to minimize the difference between the frequency reference and actual motor speed.

The ASR controller in SLV mode uses a speed estimator to estimate the motor speed. In order to reduce speed feedback interference, a low-pass filter and speed feedback compensator can be enabled.

The ASR integrator output can be disabled or limited. The ASR output is passed through a low-pass filter.

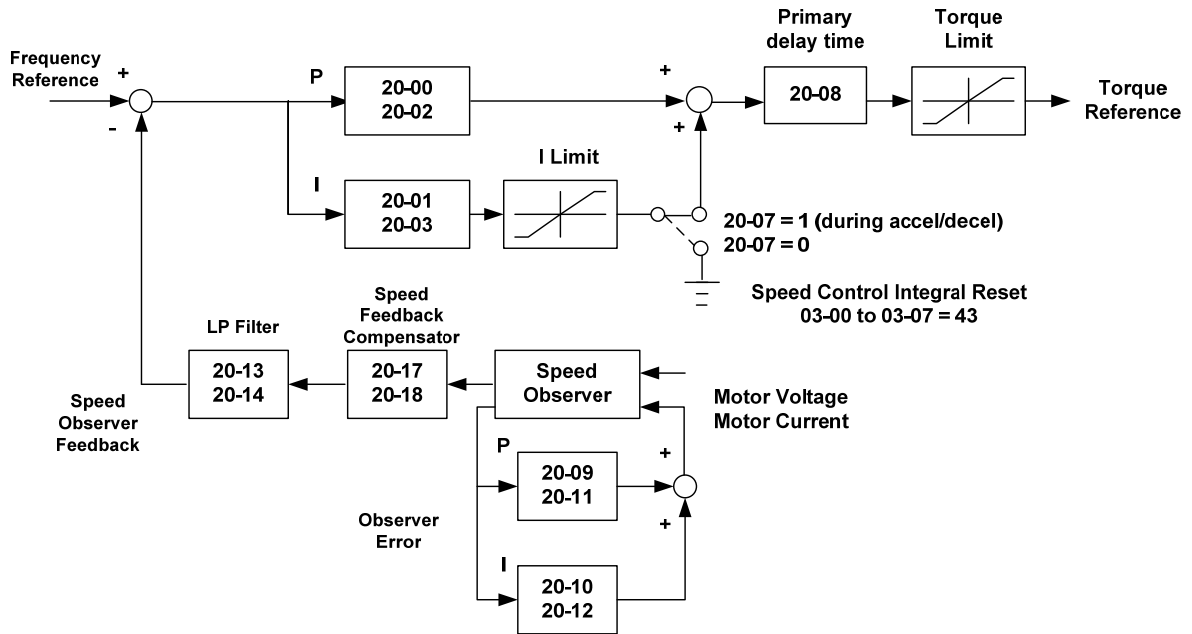

**Figure 4.4.114 ASR block diagram (SLV mode)**



**SV control mode and PMSV mode:**

The ASR function adjusts the output frequency to control the motor speed to minimize the difference between the frequency reference and actual motor speed.

The ASR controller in SLV mode uses a speed estimator to estimate the motor speed. In order to reduce speed feedback signal interference, a low-pass filter and speed feedback compensator can be enabled.

The ASR integrator output can be disabled or limited. The ASR output is passed through a low-pass filter.

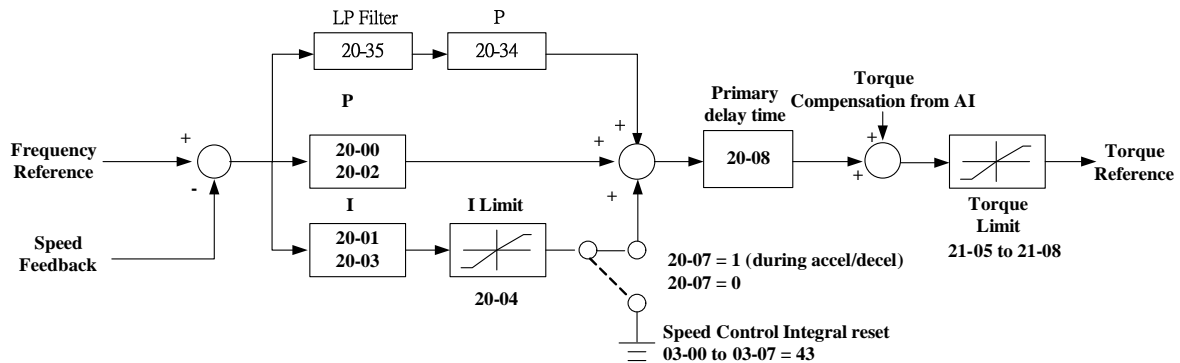

**Figure 4.4.115 Speed control block diagram (SV & PMSV mode)**

**ASR setting in V/F +PG control mode**

In V/F+PG mode, set the proportional (P) gain and integral (I) time at the minimum output frequency (20-02 and 20-03) and maximum output frequency (20-00 and 20-01). Refer to the figure 4.4.116.

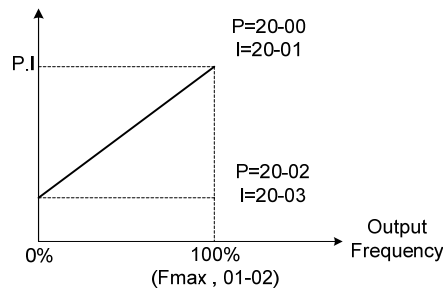

**Figure 4.4.116 ASR gain setting (V/F+PG)**

**Tuning the speed control ASR gain:**

a) ASR gain tuning at minimum output frequency

1. Operate the motor at the lowest output frequency.
2. Increase the ASR proportional gain 2 (20-02) as much as possible without causing instability.
3. Decrease the ASR integral time 2(20-03) as much as possible without causing instability.
4. Check that the output current is less than 50% of the inverter rated current.

If the output current is more than 50% of the inverter rated current, decrease 20-02 and increase 20-03.

b) ASR gain tuning at maximum output frequency

1. Operate the motor at the highest output frequency (Fmax).
2. Increase the ASR proportional gain 1 (20-00) as much as possible without causing instability.
3. Decrease the ASR integral time 1(20-01) as much as possible without causing instability.

c) The gain tuning of acceleration / deceleration integral control (20-07)

1. To enable during acceleration / deceleration operation set 20-07 = 1 (enabled), the integral control is enabled.
2. Integral control enables the motor speed to reach its target speed as soon as possible, but it may result in over or undershoot, as shown in Figure 4.4.114 & 4.4.115.
3. When one of multi-function digital inputs (03-00 to 03-07) is set to 43 (speed control integral reset), the input can be used to switch between P control and PI control of the speed control loop system (ASR). When the multi-function digital input is on, only P control is active and the integral is reset.
  - a. If the speed overshoot occurs, reduce 20-00 system (ASR proportional gain) and increase the 20-01 system (ASR integral time 1).
  - b. If the desired speed is not reached, reduce 20-02 system (ASR proportional gain 2) and increase 20-03 (ASR integral time 2).
  - c. If you cannot eliminate the speed over or undershoot using the gain tuning described above, decrease the ASR + / - limit (20-05 / 20-06), to decrease the reference frequency compensation ( $\Delta f$ ) limit. Since 20-05/20-06 cannot be changed during running, it is necessary to stop the inverter first and then decrease the ASR + / - limit.
4. See figure 4.4.117, observe the motor speed waveform and tune the gain at the same time.

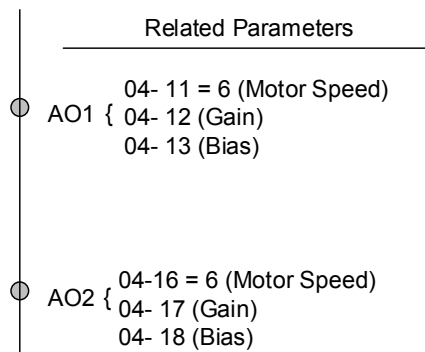

**Figure 4.4.117 Analog output setting**

d) ASR+/-limit (20-05, 20-06)

ASR +/-limit is ASR frequency compensation limit and is set as a percentage of the maximum frequency output 01-02.

**Note:** If the frequency limit is set too low, the actual motor speed may not reach the target speed.

### ASR setting (SV/SLV/PMSV control mode)

In SLV mode the ASR gain is divided into a high-speed and low-speed section. The speed controller has a high-speed gain 20-00/20-01 and a low-speed gain 20-02/20-03 that can be set independently.

- a) The high/low switch frequency can be set with parameter 20-15 and 20-16. Similar to the ASR gain, the speed estimator has a high-speed gain 20-09/20-10 and a low-speed gain 20-11/20-12.
- b) The speed estimator has a low-pass filter to reduce the speed feedback interference, parameter 20-13 and 20-14 are active at high speed as well as low speed. The switch between the high-speed and the low-speed is set by parameter 20-15 and 20-16.
- c) 20-17 sets the low-speed compensation gain of the speed feedback.
- d) 20-18 sets the high-speed compensation gain of the speed feedback.
- e) When the frequency reference is rises above the value set in 20-16, the ASR gain used is set by parameters 20-00 and 20-01.
- f) When the frequency reference falls below the value set in 20-15, the ASR gain used is set by parameters 20-02 and 20-03.
- g) Gain time constant is adjusted linearly when the speed command falls within the range of 20-15 to 20-16, for a smooth operation.

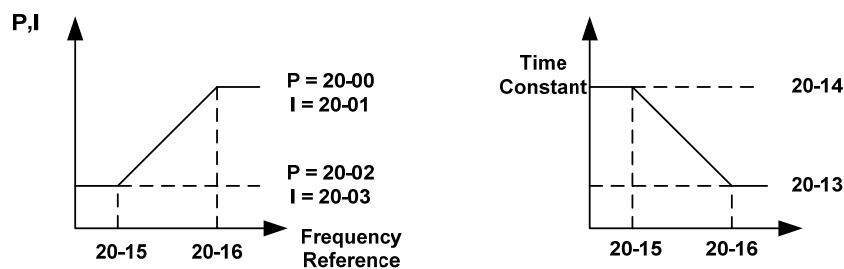

Figure 4.4.118 ASR gain setting (SLV mode)

### SV and PMSV gain setting

In SV and PMSV mode the ASR gain is divided into a high-speed and low-speed section. The speed controller has a high-speed gain 20-00/20-01 and a low-speed gain 20-02/20-03 that can be set independently.

### Tune the speed control gain

During ASR gain tuning, the multi-function analog output (AO1 and AO2 terminal) can be used to monitor the output frequency and motor speed (as shown in figure 4.4.113). Use parameters 20-00 ~ 20-03 for full speed range gain tuning in SV and PMSV mode.

- a) Complete the parameter tuning in normal operation.
- b) Increase ASR proportional gain 1 (20-00), ASR proportional gain 2 (20-02), carefully monitor system stability.

Use parameter 20-00 and 20-02 to adjust the speed response for each cycle. Tuning the settings of 20-00, 20-02 can increase system response, but may cause system instability. See figure 4.4.119.

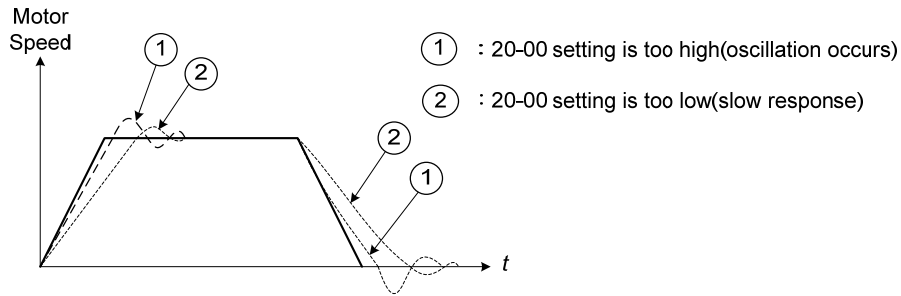

**Figure 4.4.119 System response of ASR proportion gain**

- a) Reduce ASR integral time 1(20-01), ASR integral time 2 (20-02) and carefully monitor system stability.
1. A long integral time will result in poor system response.
  2. If the integral time setting is too short, the system may become unstable Refer to the following figure.

While tuning ASR P and I gain the system may overshoot and an over voltage condition can occur. A braking unit (braking resistor) can be used to avoid an over voltage condition.

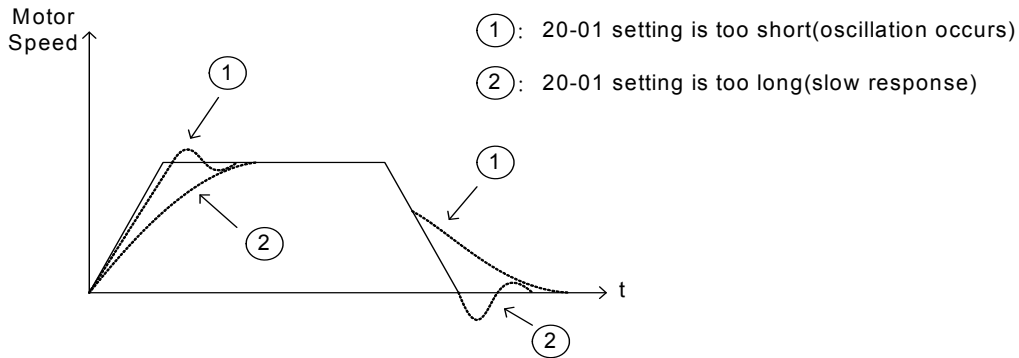

**Figure 4.4.120 The response of ASR integral time**

**SLV mode gain tuning (20-00~20-03, 20-09~20-18) and SLV2 mode gain tuning (20-15, 20-16)**

Tune the low-speed ASR P and I gain 20-02 ~ 20-03, make sure the reference frequency is below the value of parameter 20-15. P gain and integral time tuning is the same as for parameter 20-00 and 20-01 in SV mode.

Tune the high-speed ASR PI gain 20-00~20-01, make sure the reference frequency is above parameter 20-16 value. P gain and integral time tuning is the same as for parameter 20-00 and 20-01 under SV mode.

Both low-speed ASR gain and the high-speed gain can be set to the same values and only require to be adjusted in case of system instability.

In case tuning of the ASR P and I gain 20-00~20-03 does not improve the system response, reduce the low-pass filter time constant 20-13~20-14 to increase the bandwidth of the feedback system and re-tune the ASR gain.

- Tune low-speed low-pass filter time constant 20-14, make sure the reference frequency is below parameter 20-15 value
- Tune high-speed low-pass filter time constant 20-13 at frequency reference, make sure the reference frequency is above parameter 20-16 value.
- Increasing the low-pass filter time constant can limit the bandwidth of the speed feedback system and may

reduce the system response. Increasing the low-pass time reduces the speed feedback signal interference but may result in sluggish system response when the load suddenly changes. Adjust the low-pass filter time if the load stays fairly constant during normal operation. The low bandwidth of the speed feedback must be supported by the low gain of ASR to ensure stable operation.

- Decreasing the low-pass filter time constant may increase the bandwidth of the speed feedback and the system response. Decreasing the low-pass time may increase the speed feedback interference resulting in system instability when the load suddenly changes. Decreasing the low-pass filter time is a quick system response is required for rapidly changing loads. The high bandwidth of the speed feedback allows for a relative high ASR gain.
- In case tuning 20-00 ~ 20-03 and the low-pass filter time constant 20-13 do not improve the system response time, tuning the PI gain 20-09 ~ 20-12 of the speed estimator may be required.
- Setting a high gain for the speed estimator (high proportion (P) gain and small integral (I) time) increases the bandwidth of the speed feedback, but may cause speed feedback interference resulting in system instability.
- Setting a low gain for the speed estimator (small proportion (P) gain and high integral (I) time) decreases the bandwidth of the speed feedback, may improve speed feedback interference resulting in a more stable system.
- The default values for the ASR can be used in most applications, no adjustment is required. Adjusting the low-pass filter time and speed estimator gains requires a good understanding of the overall system. If a high-speed system response in combination with stable operation is required consider using SLV or SV control mode.
- Parameter 20-15 sets the gain switch frequency at low-speed and parameter 20-16 sets the gain switch frequency at high-speed.
- Operating at a speed below 20-15 will result in a larger excitation current for low-speed operation accuracy. When the frequency reference rises above 20-16, the inverter will output the rated excitation current at the no-load voltage (02-19).
- For general purpose applications parameter 20-15 should be set to a value of 5 ~ 50% of the motor base frequency.
- If this value is too high, the inverter output may saturate. Parameter 20-16 should be set to a value of 4Hz or more above the value of 20-08.
- When experiencing speed jitter at high speed and stable operation during mid-range speed while operating a heavy load (>100%), it is recommended to reduce the no-load voltage (02-19) or tune the FOC parameters (18-05 ~ 18-06).
- Parameter 20-17 and 20-18 are for compensating speed feedback at low speed and high speed.

- Use parameter 20-17 to adjust the torque compensation gain for the low speed range. By tuning 20-17 an offset is added to the torque-speed curve. Increase 20-17 when the no-load speed is lower than the frequency reference. Decrease 20-17 when the no-load speed is higher than the frequency reference. The effect on the torque-speed curve from 20-17 is shown as the following figure:

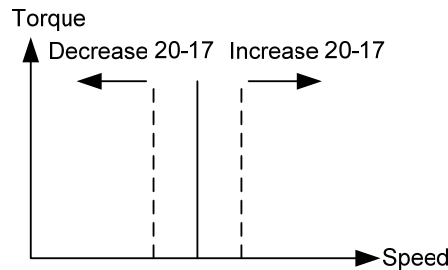

**Figure 4.4.121 Effect on the torque-speed curve from 20-17**

- Use parameter 20-18 to adjust the torque compensation gain for middle to high speed range. For most general purpose applications it is not necessary to adjust the 20-18. By tuning 20-18 an offset is added to the torque-speed curve. Increase 20-18 when the no-load speed is lower than the frequency reference. Decrease 20-18 when the no-load speed is higher than the frequency reference. The effect on the torque-speed curve from 20-18 is shown as the following figure 4.4.122.

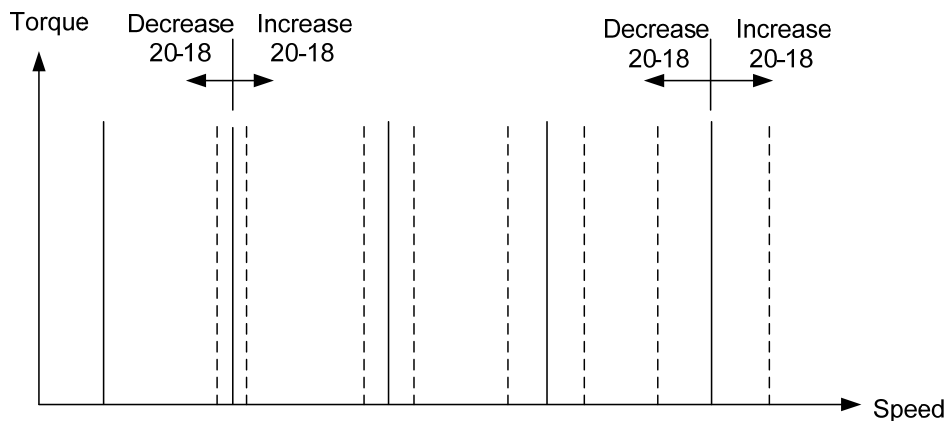

**Figure 4.4.122 Effect on the torque-speed curve from 20-17**

- ①. ASR main delay time (20-08).
  - a) Does not required to be adjusted for general purpose applications
  - b) When the set value of 20-08 is set high, the speed response will and therefore system response will decrease improving system stability.
- ②. ASR integral limit (20-04)
  - a) Setting a small value may prevent system response when the load suddenly changes.

<b>20-19</b>	<b>Overspeed (OS) selection</b>
<b>Range</b>	0: Deceleration to stop 1: Coast to stop 2: Continue to operate
<b>20-20</b>	<b>Overspeed (OS) detection level</b>
<b>Range</b>	0~120 %
<b>20-21</b>	<b>Overspeed (OS) detection time</b>
<b>Range</b>	0.0~2.0 sec
<b>20-22</b>	<b>Speed deviation (DEV) selection</b>
<b>Range</b>	0: Deceleration to stop 1: Coast to stop 2: Continue to operate
<b>20-23</b>	<b>Speed deviation (DEV) detection level</b>
<b>Range</b>	0~50 %
<b>20-24</b>	<b>Speed deviation (DEV) detection time</b>
<b>Range</b>	0.0~10.0 sec
<b>20-25</b>	<b>Selection of PG Open</b>
<b>Range</b>	0: Deceleration to stop 1: Coast to stop 2: Continue to operate
<b>20-26</b>	<b>Detection time of PG Open</b>
<b>Range</b>	0.0~10.0 Sec
<b>20-27</b>	<b>PG pulse number</b>
<b>Range</b>	0~60000 ppr
<b>20-28</b>	<b>Selection of PG rotation direction</b>
<b>Range</b>	0: Forward as counter -clockwise rotation 1: Forward as clockwise rotation
<b>20-29</b>	<b>PG pulse dividing ratio</b>
<b>Range</b>	001~132
<b>20-30</b>	<b>PG gear ratio 1</b>
<b>Range</b>	1~1000
<b>20-31</b>	<b>PG gear ratio 2</b>
<b>Range</b>	1~1000

- PG card is required (JN5-PG-O/JN5-PG-L/JN5-PG-PM)  
PG pulse divider ratio can be set parameter 20-29.

■ PG feedback setting

(1) Over speed operation setting (20-19 to 20-21)

- a) When the motor speed exceeds the tuning limit, an error is detected.  
If the motor speed feedback exceeds the value of 20-20 (overspeed detection level) for the time specified in 20-12 (over speed detection delay time) an over-speed (OS) condition is detected.
- b) Overspeed detection selection (20-19) specifies the stop method for the inverter in case of an overspeed condition.

(2) PG Speed deviation setting (20-22 to 20-24)

- a) When the speed deviation (difference between the set speed and the actual motor speed) exceeds the tuning limit, an error is detected.
- b) If the speed deviation is greater than the value of 20-23 (deviation detection level) for the time specified in 20-24 (deviation detection delay time), a speed deviation (DEV) is detected.
- c) Speed deviation is based on the reference frequency  $\pm$  speed deviation width, parameter 20-23.
- d) Speed deviation detection selection (20-22) specifies the stop method for the inverter in case of a speed deviation condition.

(3) PG detection setting (20-25 to 20-26)

- a) When the inverter no longer received pulses fro, the PG feedback for the time specified in 20-26 a PG open condition is detected.
- b) PG open detection selection (20-25) specifies the stop method for the inverter in case of a PG open condition.

Refer to figure 4.4.123 for the PG fault detection block diagram.

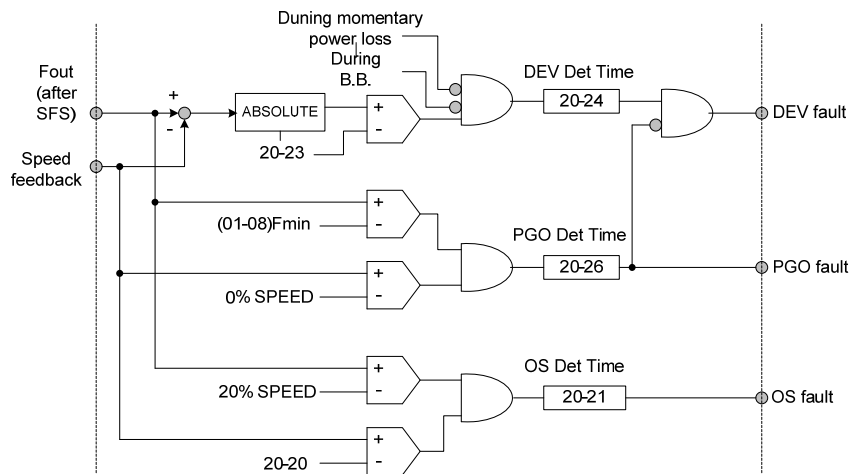

**Figure 4.4.123 Logic diagram PG feedback failure detection**

(4) Set PG pulse (20-27)

- a) Set PG of pulse number of the encoder for phase A or phase B for each cycle
- b) If a gearbox is used between the motor and PG the gear ratio can be set with parameter 20-30 and 20-31.

(5) PG rotation direction (20-28)

Parameter is used to set the motor direction and PG direction. Make sure phase A or phase B is leading for motor forward direction operation.



**20-28=0:** Forward operation, phase A is leading (phase B is leading for reversal operation).

**20-28=1:** Forward operation, phase B is leading (phase A is leading for reversal operation).

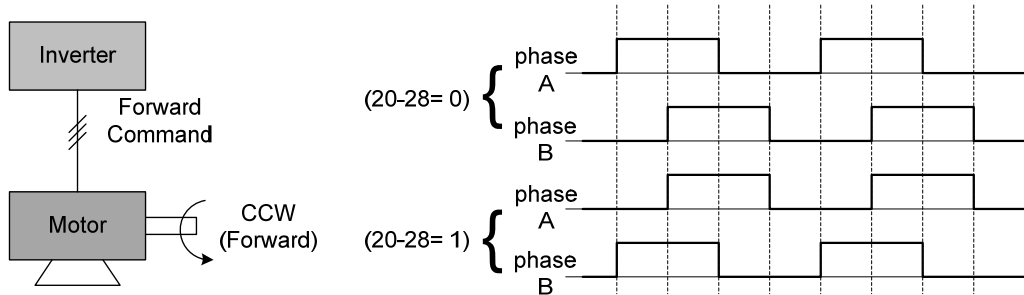

**Figure 4.4.124 PG and motor rotation direction**

Motor direction is determined as below:

Forward: The motor direction is counter-clockwise when inverter runs in forward direction (see figure 4.4.125.)

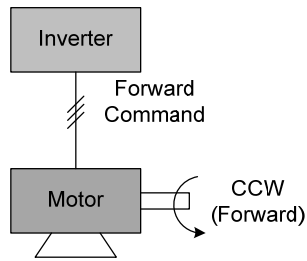

**Figure 4.4.125 Motor operation direction**

Forward: The motor direction is clockwise when inverter runs in forward direction (see figure 4.4.126.)

Refer to the below figure 4.4.126 for PG feedback pulses.

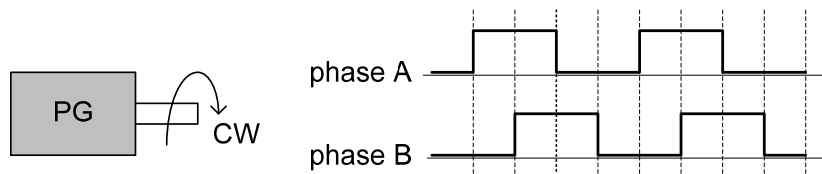

**Figure 4.4.126 PG operation direction**

(6) PG pulse dividing ratio (20-29)

Set the pulse divider ratio between the PG input and PG output.

The left most digit (3<sup>rd</sup>) represent the numerator and the last to represent the denominator.

Ratio is calculated as follows:

$$20-29 = \square \square \square, = \underline{n} \underline{kk}$$

Range n: 0 to 1

Range k: 1 to 32

$$\text{Ratio} = (1+n)/k$$

**Examples:**

20-29=001 → n=0, k=1, proportion = (1+0)/1=1

20-29=032 → n=0, k=32, proportion = (1+0)/32=1/32

20-29=132 → n=1, k=32, proportion = (1+1)/32=1/16

(7) Gear ratio of PG and motor (20-30, 20-31).

Gear ratio specifies when a gearbox is connected between the PG and the motor

- a) Set the gear ratio of the load side parameter 20-31.
- b) Set the gear ratio of the motor side parameter 20-30.

Motor speed is calculated as follows:

$$\text{Motor Speed(RPM)} = \frac{\text{No. of input pulses from PG} \times 60}{\text{PG pulses (20-27)}} \times \frac{\text{No. of PG gear teeth 2 (20-31)}}{\text{No. of PG gear teeth 1 (20-30)}}$$

**Note:** The response speed in V / F + PG mode is less than that of SV mode.

<b>20-32</b>	<b>Special encoder selection</b>
<b>Range</b>	0: None 1: Resolver

Select encoder type. Power to the inverter needs to be cycled for changes to take effect.

Note: Resolver card doesn't support position mode.

<b>20-34</b>	<b>Compensation Gain of Derating</b>
<b>Range</b>	0~25600

This gain effect is the same as ASR proportional gain (20-00, 20-02). And if this parameter is coupled with low-pass filter time constant (20-35), it can avoid oscillation.

It is suggested that the setting value of parameter 20-34 is 30~50.

<b>20-35</b>	<b>Compensation Time of Derating</b>
<b>Range</b>	0~30000 mSec

This time constant is used for suppressing the oscillation produced by 20-34. But too large compensation time constant will cause slower output response and then is unfavorable for turned compensation.

It is suggested that the setting value of parameter 20-35 is 50~100ms..

Refer to Fig.4.4.113 and Fig. 4.4.114. Torque compensation function of derating can reduce the characteristics of ASR turning around under shock load.

<b>20-43</b>	<b>MPG speed magnification calculation</b>
<b>Range</b>	1 ~ 500
<b>20-44</b>	<b>MPG speed command limit</b>
<b>Range</b>	0.1 ~ 30.0 Hz

In manual pulse generator (MPG) mode, the speed calculated by the MPG Input is multiplied by the parameter (20-43) speed multiplier, and is limited by the parameter (20-44) speed command, to perform speed command upper limit.

21-Torque And Position Control Parameters	
<b>21-00</b>	<b>Torque control selection</b>
<b>Range</b>	0: Speed control 1: Torque control
<b>21-01</b>	<b>Filter time of torque reference</b>
<b>Range</b>	0~1000 msec
<b>21-02</b>	<b>Speed limit selection</b>
<b>Range</b>	0: according AI input 1: according to the set value of 21-03 2: Input by the Communication Address (2502H)
<b>21-03</b>	<b>Speed limit value</b>
<b>Range</b>	-120~120 %
<b>21-04</b>	<b>Speed limit bias</b>
<b>Range</b>	0~120 %

**21-00:** Torque control selection  
Select between speed control and torque control in SV mode.

**21-00= 0:** Speed control (20-00, 20-09), ASR setting  
**21-00= 1:** Torque control (21-01 to 4), torque control setting

A multi-function digital input terminal (03-00 to 03-08) set to 44 (speed / torque control switching) can be used to switch between speed and torque mode externally. When the input terminal is active torque control is selected otherwise speed control is selected.

Refer to figure 4.4.114 for the speed control architecture and figure 4.4.127 for torque control architecture.

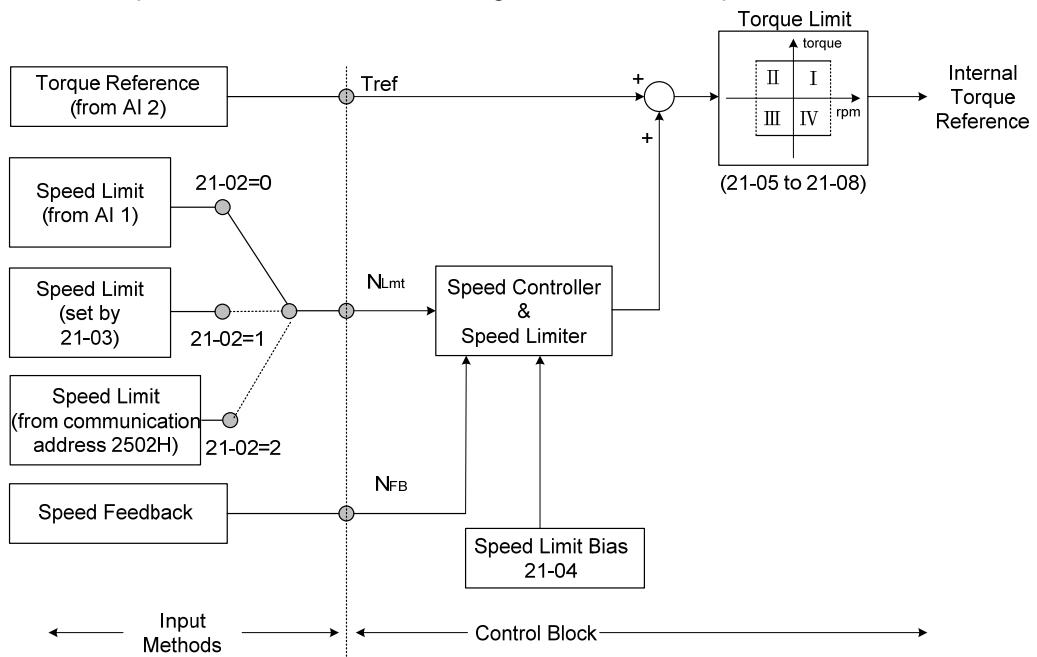

Figure 4.4.127 Block figure of the torque control

## Torque Control

The torque reference command (Tref) uses analog input AI2 (04-05=15)

**Note:** Torque reference command cannot be set via the keypad.

Multi-function analog input (AI2) can be used for torque reference (04-05=15) (torque) or torque compensation level (04-05=16).

The direction (torque output) of the motor depends on the polarity of the analog input signal (AI2) instead of the direction of the run command.

Analog input AI2: Positive voltage forward torque reference (Motor direction counter clockwise).

Analog input AI2: Negative voltage reverse torque reference (Motor direction clockwise).

To switch to a negative torque reference set one of the multi-function digital input (03-00 to 03-07) to 45 (negative torque command), and activate the digital input terminal (Motor direction clockwise).

**Table 4.4.41 Torque input method**

Input	Input terminal	Parameter setting	Description
Voltage input (0 - 10V)	AI2	04-00=0,2	Terminal AI2 signal level: 0 - 10V
	Selection "V"	04-05=15	AI2 used as for torque reference
Current input (4 - 20mA)	AI2	04-00=1,3	Terminal AI2 signal level: 4 - 20mA
	Selection "I"	04-05=15	AI2 used as for torque reference

### 21-01: Torque filter time

Time constant used to reduce the torque signal interference and adjust the torque response. Increase filter time in case the system becomes unstable.

### 21-02/21-03: Speed limit input setting

Limits the motor speed while operating in torque control. When the external torque reference and the system load are out of balance the speed limit may be used to prevent the motor from damaging the system.

The speed limit can be set via the digital inputs or using an analog input signal to set the speed limit level. Refer to the table 4.4.17 for the speed limit input method.

**Table 4.4.42 Speed limit input method**

Input method		Input terminal	Related parameter setting	Description
1	Voltage input (-10V – 10V)	AI1	21-02=0	Analog input (AI1 or AI2) as speed limit
			00-05=1	Analog input (AI1 or AI2 is set by 04-05 ) as reference frequency input
			04-00=2,3	Terminal AI1 signal level : -10V - 10V (if the speed limit is plus value, set 04-00=0, 1)
	Voltage input (10V - 10V)	AI2 (Selection = "V")	21-02=0	Analog input (AI1 or AI2) as speed limit
			00-05=1	Analog input (AI1 or AI2 is set by 04-05 ) as reference frequency input
			04-00=0,2	Terminal AI2 signal level : 0V - 10V
			04-05=12	AI2 will be added to terminal AI1 as speed limit value
	Current input (4 - 20mA)	AI2 (Selection = "I")	21-02=0	Analog input (AI1 or AI2) as speed limit
			00-05=1	Analog input (AI1 or AI2 is set by 04-05 ) as reference frequency input
			04-00=1,3	Terminal AI2 signal level : 4 – 20mA
			04-05=12	AI2 will be added to terminal AI1 as speed limit value
	2	Parameter 21-03 setting	—	21-02=1
21-03				Set speed limit
3	Communication Input (2502H)	S+ & S-	21-02=2	Communication is used to be the speed limit.

The rotation direction in speed control depends on the speed limit signal:

- Positive voltage: Forward, speed limit (21-03 + 21-04).
- Reverse speed limit is zero or reversal direction (-21-04).
- Negative voltage: Reverse, speed limit (-21-03-21-04).
- Forward, speed limit is zero or forward direction (21-04).

If the speed limit bias is set to 0, the motor speed will be limited to 0 when the rotation direction of the motor and the speed limit are in reverse.

**Example:** The speed limit analog signal is a positive voltage and the motor is in forward operation, then the effective speed range in torque control is from 0 to the analog speed limit value.

#### **21-04:** Speed limit bias setting

Speed limit bias (21-04) is used to adjust the boundaries of the speed limit. The speed limit bias (21-04) can be used to set the same limit value in forward and reversal direction and is set as a percentage of the maximum output frequency (01-02).

**Example 1:** Set 30% speed limit in forward and reverse direction.

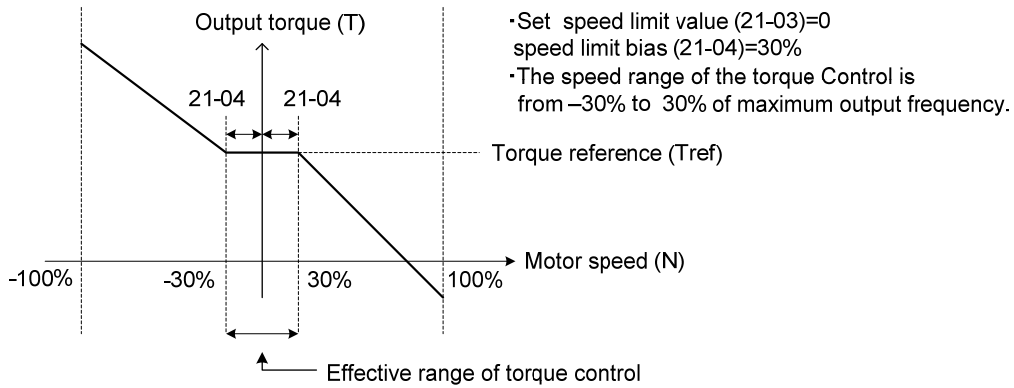
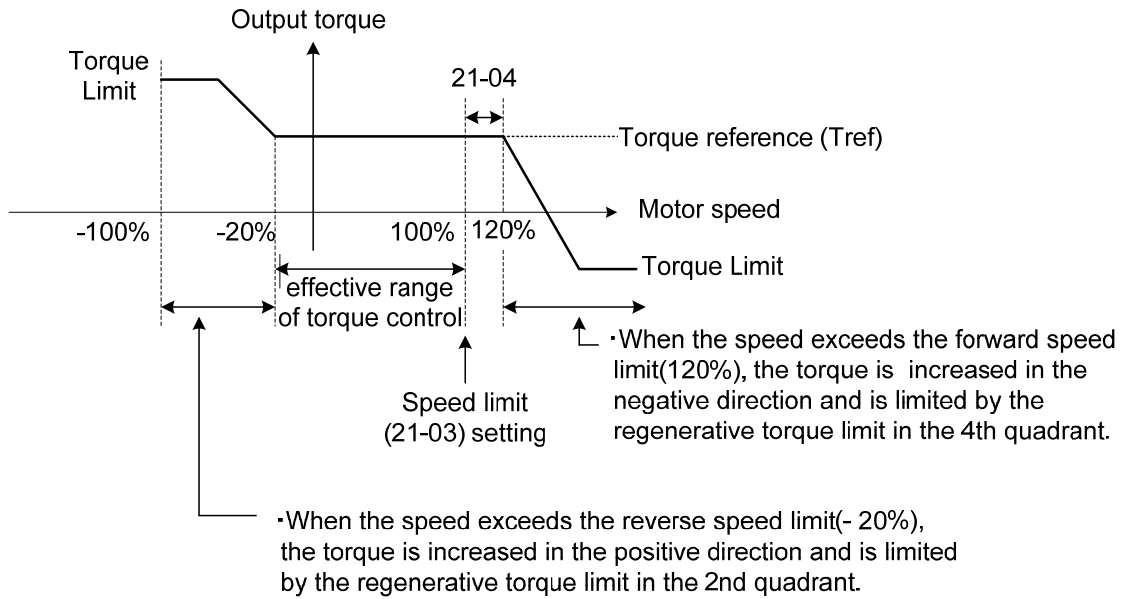

**Figure 4.4.128 Speed limit setting**

**Example 2:**

- Settings: 1. Speed limit value (21-03) =100% (positive speed limit)  
 2. Speed limit bias (21-04) = 20%

The speed range in torque control is from -20% (21-04) to 120% (21-03+21-04)



**Figure 4.4.129 Speed limit setting (Example 2)**

**Example:** Torque limit and speed limit operation:

In this example the torque limit and speed limit are used in a winding and unwind operation.

**Winding operation**

The line speed (N) and motor torque (T) are in the same direction of the motor. Refer to Figure 4.4.130

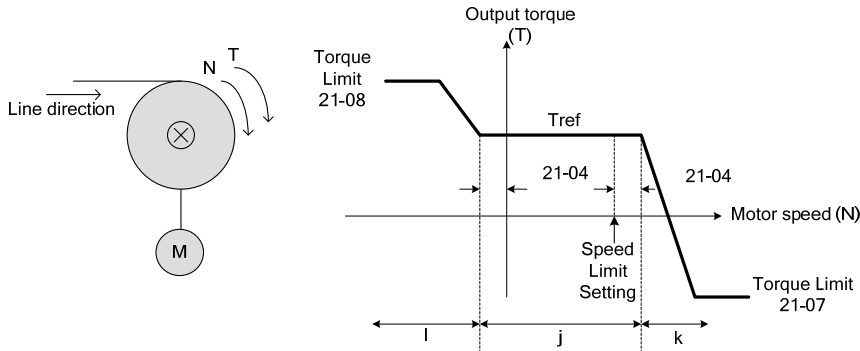
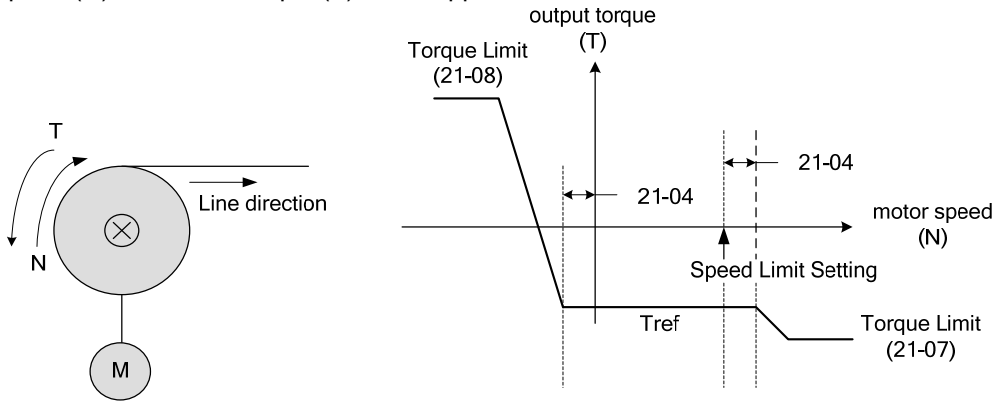

**Figure 4.4.130 Winding operation**

- ①. Speed limit bias (-21-04) > Motor Speed > speed limit bias (+21-04) → torque based on Tref.
- ②. Motor speed (N) > speed limit bias +21-04 → speed limit will output negative torque to prevent the increase of motor speed.
- ③. Motor speed (N) < -21-04 → speed limit will output a forward torque to prevent an increase of speed.

**Unwinding operation**

The line speed (N) and motor torque (T) are in opposite direction



**Figure 4.4.131 Unwind operation**

The relationship among Tref (torque reference), NLmt (speed limit) and N (motor speed) is shown below when used in winding operation and roll-out operation.

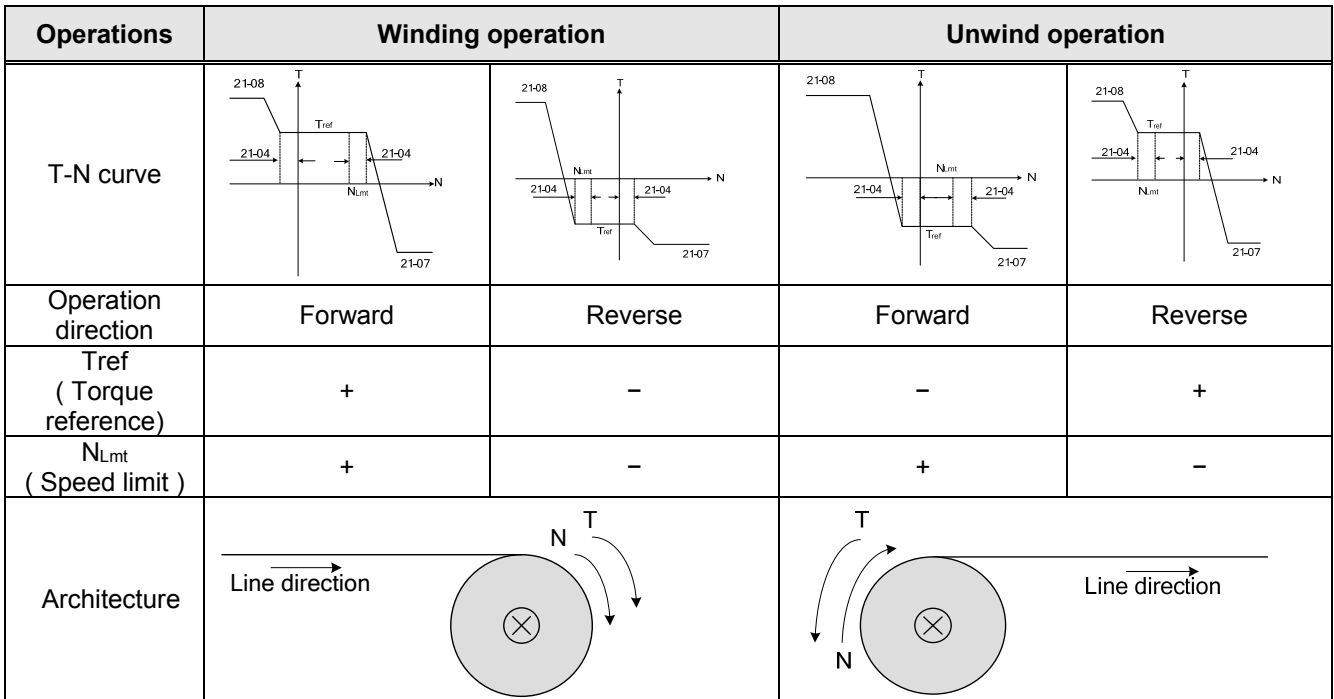

Figure 4.4.132 Winding and roll-out operations

### Torque compensation

Torque compensation is used to compensate for torque loss due to mechanical damage or other losses. Multi-function analog input AI2 can be used for torque compensation (04-05 = 16, 04-07/08 Gain/ Bias).

Set the appropriate signal level for the torque compensation. The torque compensation direction is based on the analog signal polarity, not by the direction of the run command.

When Tcomp is fixed at a positive voltage (or current) results in a positive torque compensation (the rotation of motor shaft is counterclockwise).



<b>21-05</b>	<b>Positive torque limit</b>
<b>Range</b>	0~300 %
<b>21-06</b>	<b>Negative torque limit</b>
<b>Range</b>	0~300 %
<b>21-07</b>	<b>Forward regenerating torque limit</b>
<b>Range</b>	0~300 %
<b>21-08</b>	<b>Reversal regenerating torque limit</b>
<b>Range</b>	0~300 %

Use the torque limit function to limit the torque applied to the load, or limit the regenerative torque.

In speed control the torque limit function has a higher priority than the motor speed control and compensation. This might result in extended acceleration, deceleration times and a reduction in motor speed.

Torque limit can be set in two ways:

- Use torque limit parameters (21-05 to 21-08) to set a fixed torque limit.
- Set the torque limit by using the multi-function analog input (AI2).

There are four torque limits that can be set separately, one for each quadrant:

- (I) Positive torque limit in forward direction (21-05 positive torque limit)
- (II) Positive torque limit of reverse direction (21-06 negative torque limit)
- (III) Negative torque limit in reverse direction (21-07 forward regenerating torque limit)
- (IV) Negative torque limit in forward direction (21-08 reversal regenerating torque limit)

Refer to Figure 4.4.133.

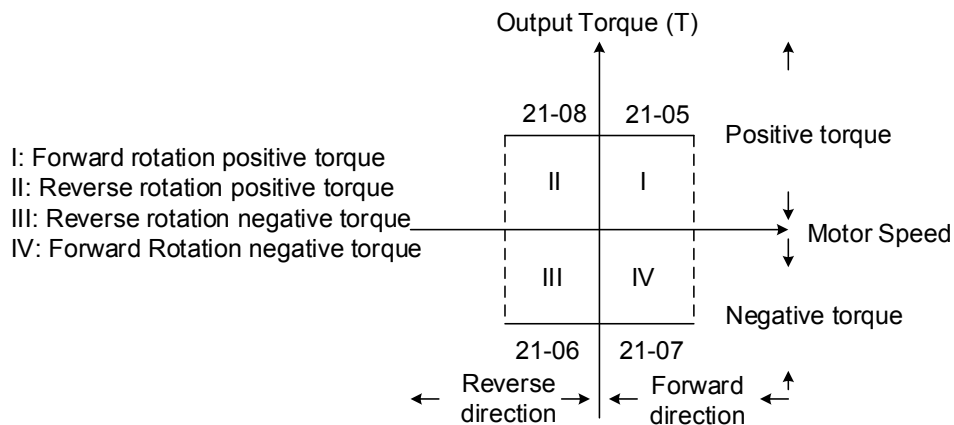

**Figure 4.4.133 Torque limit setting**

Torque limit setting by using multi-function analog input AI2 (04-05)

**Table 4.4.43 Torque limit analog input**

04-05 (AI2)	Function
11	Positive torque limit
12	Negative torque limit
13	Regenerative torque limit (for both forward and reversal directions).
14	Positive/negative torque limit (positive and negative detection torque limit )

Set the analog input terminal (AI2) signal level (04-00), gain (04-07) and bias (04-08)

The default setting for the analog input AI2 is 0 -10V representing 0 – 100% of the motor rated torque).

Figure 4.4.129 shows the relationship between the output torque and the torque limit.

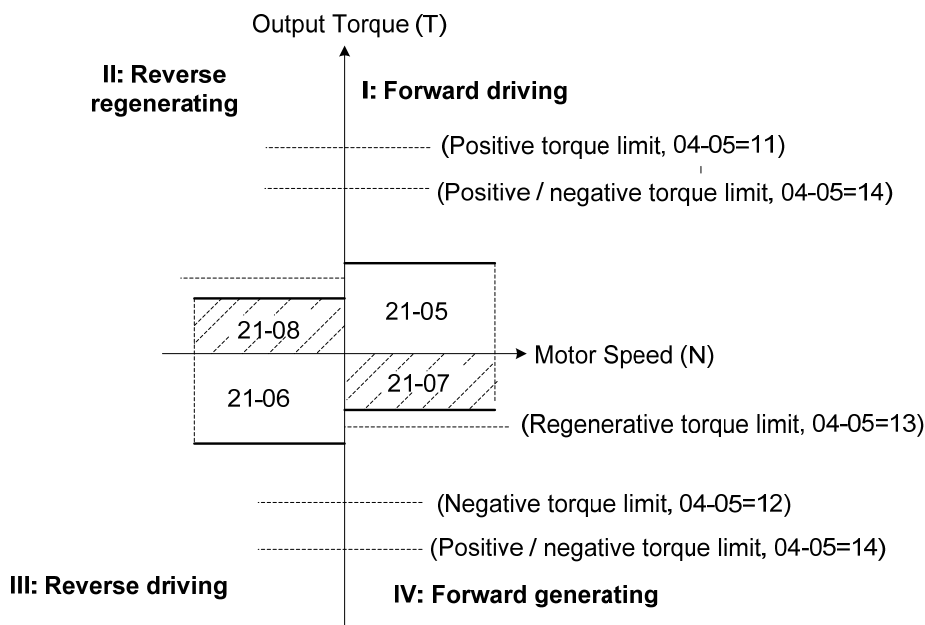

**Figure 4.4.134 Analog input torque limit (AI2)**

When the analog input is set to positive torque limit (value = 11) the torque limit is active in the third and fourth quadrant.in the reverse direction (regenerative torque in the second quadrant).

When the analog input is set to negative torque limit (value = 12) the torque limit is active in the third and fourth quadrant.

When the analog input is set to regenerative torque limit (value = 13) the torque limit is active in the second and fourth quadrant can be controlled.

When the analog input is set to positive/negative torque limit (value = 14) the torque limit is active in all four quadrants.

When the analog input is at maximum (10V or 20mA), the torque limit is 100% of the motor rated torque. In order to increase the torque limit above 100% the analog input gain (04-07) has to set to a value greater than 100%. For example: 200.0% of the gain will result in the torque limit of 200% of motor rated torque at 10V (20mA) analog input level.

<b>21-09</b>	<b>Maximum frequency of position control</b>
<b>Range</b>	0.1~100 Hz
<b>21-10</b>	<b>The command of rotation cycle number of section 0</b>
<b>Range</b>	-9999~9999
<b>21-11</b>	<b>The command of the pulse number of section 0</b>
<b>Range</b>	-9999~9999
<b>21-12</b>	<b>The command of rotation cycle number of section 1</b>
<b>Range</b>	-9999~9999
<b>21-13</b>	<b>The command of the pulse number of section 1</b>
<b>Range</b>	-9999~9999
<b>21-14</b>	<b>The command of rotation cycle number of section 2</b>
<b>Range</b>	-9999~9999
<b>21-15</b>	<b>The command of the pulse number of section 2</b>
<b>Range</b>	-9999~9999
<b>21-16</b>	<b>The command of rotation cycle number of section 3</b>
<b>Range</b>	-9999~9999
<b>21-17</b>	<b>The command of the pulse number of section 3</b>
<b>Range</b>	-9999~9999
<b>21-18</b>	<b>The command of rotation cycle number of section 4</b>
<b>Range</b>	-9999~9999
<b>21-19</b>	<b>The command of the pulse number of section 4</b>
<b>Range</b>	-9999~9999
<b>21-20</b>	<b>The command of rotation cycle number of section 5</b>
<b>Range</b>	-9999~9999
<b>21-21</b>	<b>The command of the pulse number of section 5</b>
<b>Range</b>	-9999~9999
<b>21-22</b>	<b>The command of rotation cycle number of section 6</b>
<b>Range</b>	-9999~9999
<b>21-23</b>	<b>The command of the pulse number of section 6</b>
<b>Range</b>	-9999~9999
<b>21-24</b>	<b>The command of rotation cycle number of section 7</b>
<b>Range</b>	-9999~9999
<b>21-25</b>	<b>The command of the pulse number of section 7</b>
<b>Range</b>	-9999~9999

<b>21-26</b>	<b>The command of rotation cycle number of section 8</b>
<b>Range</b>	-9999~9999
<b>21-27</b>	<b>The command of the pulse number of section 8</b>
<b>Range</b>	-9999~9999
<b>21-28</b>	<b>The command of rotation cycle number of section 9</b>
<b>Range</b>	-9999~9999
<b>21-29</b>	<b>The command of the pulse number of section 9</b>
<b>Range</b>	-9999~9999
<b>21-30</b>	<b>The command of rotation cycle number of section 10</b>
<b>Range</b>	-9999~9999
<b>21-31</b>	<b>The command of the pulse number of section 10</b>
<b>Range</b>	-9999~9999
<b>21-32</b>	<b>The command of rotation cycle number of section 11</b>
<b>Range</b>	-9999~9999
<b>21-33</b>	<b>The command of the pulse number of section 11</b>
<b>Range</b>	-9999~9999
<b>21-34</b>	<b>The command of rotation cycle number of section 12</b>
<b>Range</b>	-9999~9999
<b>21-35</b>	<b>The command of the pulse number of section 12</b>
<b>Range</b>	-9999~9999
<b>21-36</b>	<b>The command of rotation cycle number of section 13</b>
<b>Range</b>	-9999~9999
<b>21-37</b>	<b>The command of the pulse number of section 13</b>
<b>Range</b>	-9999~9999
<b>21-38</b>	<b>The command of rotation cycle number of section 14</b>
<b>Range</b>	-9999~9999
<b>21-39</b>	<b>The command of the pulse number of section 14</b>
<b>Range</b>	-9999~9999
<b>21-40</b>	<b>The command of rotation cycle number of section 15</b>
<b>Range</b>	-9999~9999
<b>21-41</b>	<b>The command of the pulse number of section 15</b>
<b>Range</b>	-9999~9999
<b>21-42</b>	<b>Pos. Mode Selection</b>
<b>Range</b>	0: Switch to position mode when output frequency < 01-08. 1: Z Phase Locked Function
<b>21-43</b>	<b>Offset Angle</b>
<b>Range</b>	0 ~9999 Pulse

**21-09 Maximum frequency for position control**

Maximum output frequency when moving to the next position. The position control function uses acceleration time 1 (00-14).

Maximum output frequency when moving to the next position. The position control function uses deceleration time 1 (00-15).

In the SV control mode, multi-function digital input terminals (03-00 to 03-07) can be used to select the position. See table 4.4.44.

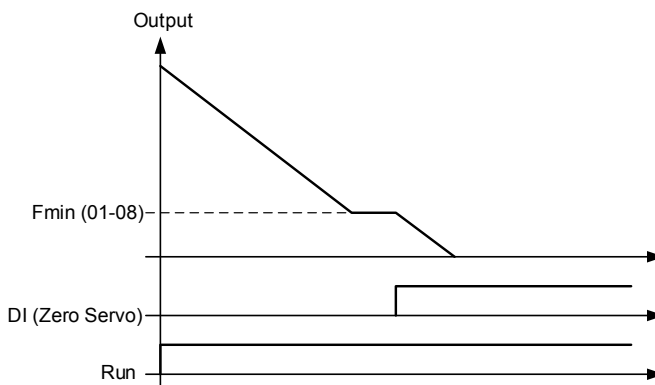

**Figure 4.4.135 Zero-servo positioning**

**Table 4.4.44 Multi-position positioning function setting**

Digital Input setting 03-00~03-07	Function
02	Multi-speed/position setting command 1
03	Multi-speed/position setting command 2
04	Multi-speed/position setting command 3
05	Multi-speed/position setting command 4
46	Zero-Servo command
51	Select between speed control and position control
52	Position command enable

**Zero-servo positioning function (Zero-Servo):**

When the output frequency falls below Fmin and the zero-servo input is active, the position is locked in and the inverter enters zero-servo positioning mode (Zero-Servo). Positioning command PosRef is origin, as shown in figure 4.4.135.

Refer to parameter 11-49 and 11-50 for zero-servo gain and zero-servo count and parameter 20-02 and 20-03 to setup the speed regulator function.

**Multi-position function (MultiPosRef):**

Parameter 21-42 is set to 0 and the speed is lower than the lowest frequency so the inverter will enter into the position mode. If input multi-speed and multi-position command switch (DI is set to 51) in the zero-servo mode,

multi-speed command 1~4 is transformed to multi-position command 1~4 and the origin of zero-servo mode has 17-section position. Refer to Fig.4.4.131.

**Spindle Positioning Function** (Z-phase locked function)

Parameter 21-42 is set to 1 and the speed is lower than the lowest frequency so the inverter will enter into the position mode when Z-phase signal appears. The origin is positioned in z phase signal and the setting value of parameter 21-43. It can be also coupled with multi-position function.

Z phase bias value of monitoring parameter 12-78 will display the bias between Z phase and the current position.

User can rotate the motor at one cycle depending on the rotation direction. Z phase bias value of parameter 12-78 is the differential value between steering position Z point after capturing the position of Z point. Make the value of 12-78 input the offset angle of parameter 21-43 after the position is confirmed. Then the origin is positioned at Z phase signal + the setting value of parameter 21-43.

**Note:** If the motor is just at power on and does not pass the Z point, parameter 12-78 will display 9999.

**Position control:**

- Activate Run command (RUN)
- Activate Zero-Servo command (Zero-Srvo)
- Activate Position enable command (MultiPosEn)
- Select a position with the multi-function digital inputs (PosRef)

Refer to figure 4.4.136.

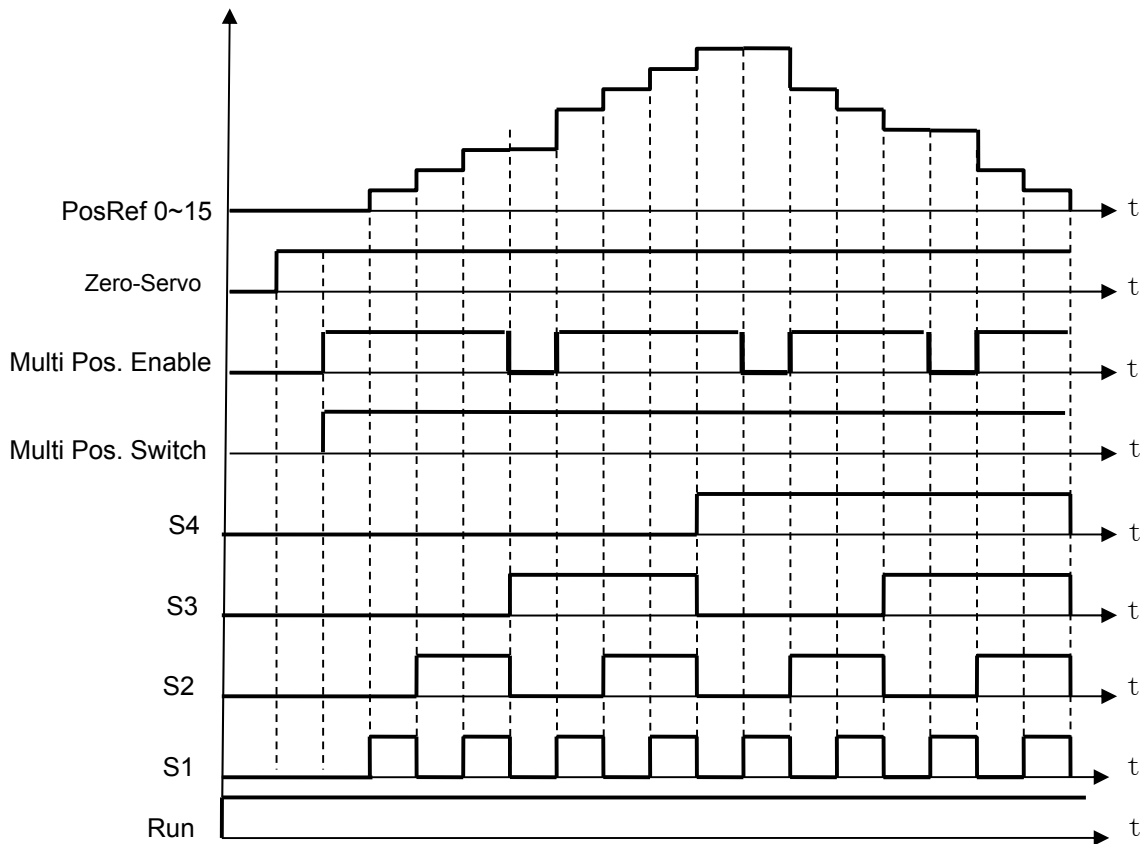
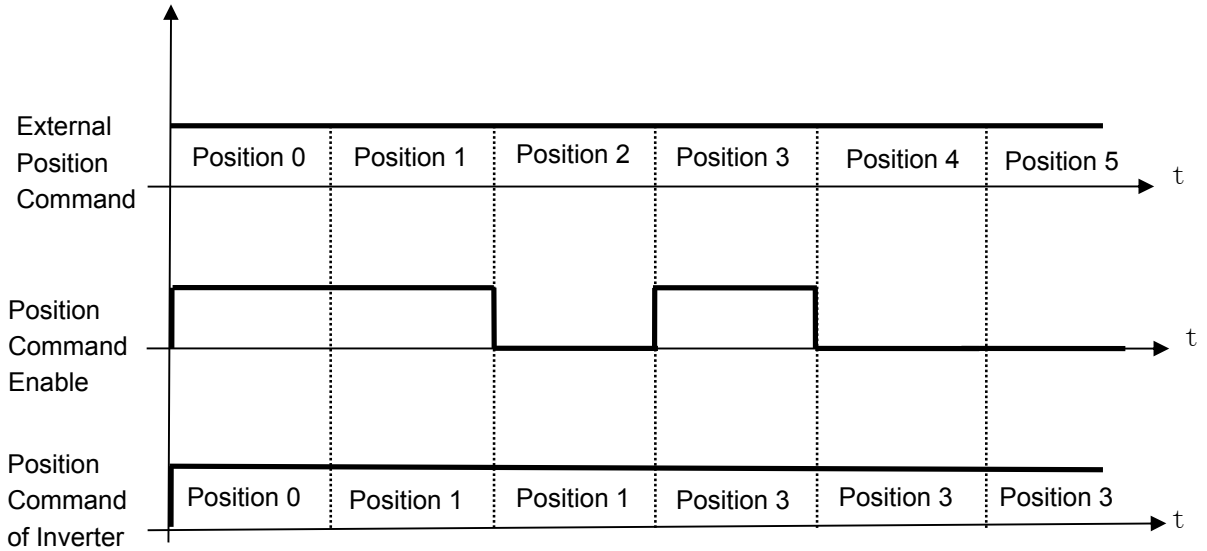

**Figure 4.4.136 Multi-positioning logic diagram**

Refer to parameter 20-28 to set PG motor direction.

A position is defined by the number of rotations plus the number of pulses.

When multi-position function is used, position command enable (Multi Pos. Enable, DI is set to 52) is required to be ON so the inverter can receive the external position command. Refer to Fig. 4.4.137.



**Fig. 4.4.137 Position Enable Diagram**

Multi-position mode is the absolute type. If the first section is at 100 pulse and make the motor rotate at more than 100 pulse, then the second section is required to set at 200 pulse. Refer to Fig. 4.4.138.

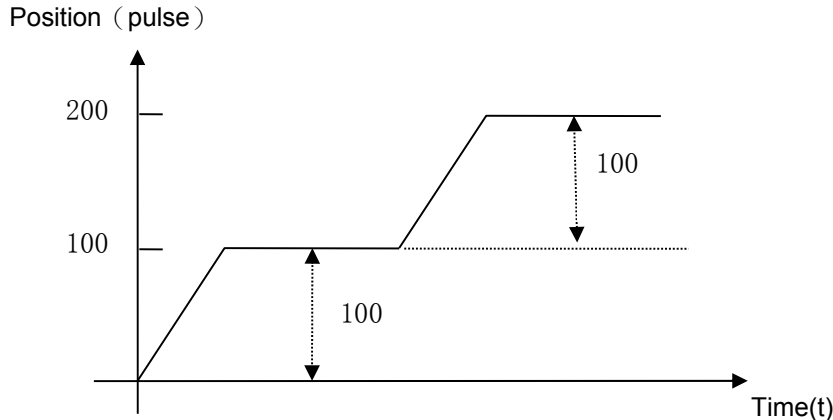

**Figure 4.4.138 the absolute type diagram**

Position setting ( 21-10~21-41 ) :

$$\text{Motor Position Setting of N section} = \text{Rotation Cycles Command of N section} \times \text{PG Pulse (20-27)} + \text{Pulse Command of N section}$$

**Example: 2 Positions**

Motor encoder is 1024 PPR.

Position 1: Rotate motor shaft in forward direction 180 degrees, set rotation cycle to 0 and pulse number to 512 (1/2 x 1024). Positive number indicated forward direction.

Position 2: Rotate motor shaft 1reverse 270 degrees (-768 pulses), set rotation cycle to 0 and pulse number to -768 (- 3/4 x 1024). Negative number indicated forward direction.

22- PM Motor Parameters	
<b>22-00</b>	<b>PM motor rated power</b>
<b>Range</b>	0.00~600.00 Kw
<b>22-01</b>	<b>PM motor rated voltage</b>
<b>Range</b>	200V: 【50 ~ 240】 V 400V: 【100 ~ 480】 V
<b>22-02</b>	<b>PM motor rated current</b>
<b>Range</b>	25%~200% inverter's rated current
<b>22-03</b>	<b>PM motor's pole number</b>
<b>Range</b>	2~96 Poles
<b>22-04</b>	<b>PM Motor's rated rotation speed</b>
<b>Range</b>	6~60000 rpm
<b>22-05</b>	<b>PM motor's maximum rotation speed</b>
<b>Range</b>	6~60000 rpm
<b>22-06</b>	<b>PM motor rated frequency</b>
<b>Range</b>	4.8~599.0 Hz
<b>22-07</b>	<b>PM type selection</b>
<b>Range</b>	【0】 SPM 【1】 IPM

The PM parameter group can be restored to factory default by initializing the inverter (13-08).

1. PM motor rated power (22-00); PM motor rated voltage (22-01); PM motor rated current (22-02)  
Setting the motor nameplate value.
2. PM motor pole number (22-03); PM motor rated rotation speed (22-04); PM motor rated frequency (22-06)  
Setting the motor nameplate value. For the PM motor rated rotation speed (22-04) and the PM motor rated frequency (22-06), just set one of the two and the program will automatically calculate the other. When setting the PM motor rated rotation speed (22-04), the PM motor's maximum rotation speed (22-05) will synchronize and update to the same setting. When using the flux-weakening function, the PM motor's maximum rotation speed (22-05) setting value must be revised. The formula is as follows:

$$(\text{PM Motor rated rotation speed}) N = \frac{120 \times f \text{ (PM Motor rated frequency)}}{P \text{ (PM Motor pole number)}}$$



3. PM motor's maximum rotation speed (22-05)

When using the flux-weakening function, the PM motor's maximum rotation speed (22-05) must be set higher than the PM motor's rated rotation speed (22-04).

4. PM type selection (22-07)

When using the SPM motor, the recommended setting is 0. Related adjustable parameters are the speed estimated gain (22-30) and the speed estimated filter value (22-31).

When using the IPM motor, the recommended setting is 1. Related adjustable parameters are the speed estimated gain (22-34) and the speed estimated filter value (22-35).

<b>22-08</b>	<b>PM Encoder Type</b>
<b>Range</b>	<b>0:</b> TAMAGAWA Non Wire-Saving Encoder <b>1:</b> TAMAGAWA Wire-Saving Encoder <b>2:</b> SUMTAK Wire-Saving Encoder <b>3:</b> General Incremental Encoder <b>4:</b> Sine Wave

<b>22-10</b>	<b>PM SLV Start Current</b>
<b>Range</b>	20% ~ 200% Motor Rated Current

<b>22-11</b>	<b>I/F Mode Start Frequency Switching Point</b>
<b>Range</b>	【 10 ~ 100 】 %

<b>22-14</b>	<b>Armature Resistance of PM Motor</b>
<b>Range</b>	0.001 ~ 30.000 Ω

<b>22-15</b>	<b>D-axis Inductance of PM Motor</b>
<b>Range</b>	0.01 ~ 300.00 mH

<b>22-16</b>	<b>Q-axis Inductance of PM Motor</b>
<b>Range</b>	0.01 ~ 300.00 mH

<b>22-17</b>	<b>PM No-Load Voltage</b>
<b>Range</b>	200V: 【 0 ~ 250 】 V 400V: 【 0 ~ 500 】 V

<b>22-18</b>	<b>Flux-weakening Current Command Restriction</b>
<b>Range</b>	0 ~ 120 %

<b>22-20</b>	<b>Offset angle of the magnetic pole and PG origin</b>
<b>Range</b>	0~360 deg

<b>22-21</b>	<b>PM motor tuning</b>
<b>Range</b>	<b>0:</b> PM Motor Tuning is not Active <b>1:</b> Parameter Auto-tuning (for PMSLV Tuning) <b>2:</b> Magnetic Pole Alignment and Loop Adjustment (for PMSV Tuning) <b>3:</b> <a href="#">Rotation Auto-tuning</a>

<b>22-22</b>	<b>Fault history of PM motor tuning</b>
<b>Range</b>	<b>0:</b> No error <b>1:</b> Static magnetic alignment fault.

	<b>2:</b> Without PG option card <b>3:</b> Rotation pole alignment is forced to stop <b>4:</b> Error of Encoder Feedback Direction. <b>5:</b> Loop adjustment is time out <b>6:</b> Encoder error <b>7:</b> Other errors of motor tuning <b>8:</b> Current abnormality occurs when aligning rotation magnetic pole <b>9:</b> Current abnormality occurs while loop adjustment <b>10:</b> Reserved <b>11:</b> Stator Resistance Measurement Timeout
--	---

<b>22-25</b>	<b>Detection Mode Selection of Initial Magnetic Pole</b>
<b>Range</b>	<b>0:</b> Upon the angle before stopping <b>1:</b> Mode 1 <b>2:</b> Mode 2 <b>3:</b> Mode 3
<b>22-26</b>	<b>High speed control ratio enable (For PMSLV)</b>
<b>Range</b>	<b>0:</b> Low Speed Open Loop Control <b>1:</b> Low Speed High Frequency Control <b>2:</b> Full Closed Loop Control
<b>22-27</b>	<b>Voltage Command of Mode 2</b>
<b>Range</b>	<b>【5 ~ 120】</b> % (22-25=2 or 22-26=1 is enabled)
<b>22-28</b>	<b>Divider Ratio of Mode 2</b>
<b>Range</b>	<b>【0~8】</b> (22-25=2 or 22-26=1 is enabled)
<b>22-29</b>	<b>Flux-weakening Voltage Command Restriction</b>
<b>Range</b>	<b>【80 ~ 110】</b> % (related to parameter 22-18)

### 22-08: PM Encoder Type

After PM encoder type is adjusted, the inverter is required to reconnect to renew the system.

If user does not need the specified encoder types, select mode 3 to avoid error occurring. When mode 3 is selected, start mode is the strong magnetic and the current is about 100% setting value of the rated current (22-02) at start. Magnetic pole search is according to parameter 22-25 or start upon the angle before stopping.

If 22-25=0, inverter at the first start after power failure drives the motor in 0 degree since the angle of motor last stop does not exist and vibration may occur at start-up.

Sine wave card is for Heidenhain ERN 1387, ECN 1313 and ECN413

#### Note:

1. Sine wave card doesn't support position mode.
2. If PG card and PM encoder is not matched, SE07 fault will occur.
3. If PM encoder type (22-08) is reset, it is required to reconnect and then perform PM motor tuning (22-21). Find the offset angle of the magnetic pole again. If the above actions are not performed, SE08 fault will occur.

### 22-10: PM SLV Start Current

Set torque current at start and the unit is the percentage of motor rated current.

### 22-11: I/F Mode Start Frequency Switching Point

This function is for the switching point from open-loop to close-loop in PMSLV mode. The unit is percentage for rated speed of motor. It recommends that over 5% for 400V and over 10% for 200V.

### 22-14: Armature Resistance of PM Motor

Set resistor for each phase of the motor in unit of 0.001Ω. It is set automatically when the motor auto-tunes (22-21).

**Note:** Do not be confused with line-to-line resistance.

#### **22-15: D-axis Inductance of PM Motor**

Set motor's D-axis inductance in unit of 0.001mH. It is set automatically when the motor auto-tunes (22-21).

#### **22-16: Q-axis Inductance of PM Motor**

Set motor's Q-axis Inductance in unit of 0.001mH. It is set automatically when the motor auto-tunes (22-21).

#### **22-18: Flux-weakening Current Command Restriction**

1. When the MTPA's selected (22-32) setting is 0, the setting parameter's (22-05) maximum motor rotation speed is higher than the parameter's (22-04) motor rated rotation speed. This will automatically activate the flux-weakening control. Set this parameter to restrict the maximum flux-weakening capability. The unit is the motor's rated current percentage.
2. When the MTPA's (22-32) selected setting is 2 or 3, and the output voltage is too high, the flux-weakening voltage command restriction setting value must be raised.

#### **22-20: Offset Angle of the Magnetic Pole and PG Origin**

Magnetic pole alignment offset value is stored in this parameter after tuning.

#### **22-21: PM Motor Tuning**

##### **WARNING!**

Sudden start: The inverter and motor may start unexpectedly during Auto-Tuning, which could result in death or serious injury. Make sure the area surrounding of the motor and load are clear before proceeding with Auto-Tuning.

##### **WARNING! Electric Shock Hazard**

High voltage is supplied to the motor when performing an auto-tune, even when the motor is stopped, which could result in death or serious injury. Do not touch the motor when performing magnetic pole realignment until the auto-tuning procedure is completed.

##### **WARNING! Holding Brake**

Do not perform a magnetic pole realignment auto-tuning procedure when the motor is connected to a brake this may result in incorrect motor data calculation.

Disconnect the motor and the load and confirm that the motor can freely run.

1. Before selecting PM motor tuning, enter the motor data (22-00) - (22-06) according to the motor nameplate and the number of encoder pulses (20-27).
2.
  - a) Use parameter 22-21 to select tuning mode. If 00-00=4 (PMSV), please set 22-21=2 to tuning. If 00-00=5 (PMSLV), please set 22-21=1 to tuning.
  - b) When 00-00 set to 4 (PMSV), if the motor pole number (22-03) is unknown, please set 22-21=2. If PM

encoder type (22-08) set to 4 (Sine wave, ECN1313, ECN413 and ERN1387) or specific encoder (20-32) set to 1 (Resolver) and the motor pole number (22-03) is known, please set 22-21=1 (Parameter auto-tune), then set to 3 (Magnetic pole alignment), the tuning time can be reduced.

Note 1: If encoder type (22-08) set to 0 ~ 3, and set 22-21=3, PM Tune Error03 will be display.

Note 2: If 22-21 set to 2 or 3 to motor tuning, and PM Tune Error04 happens, PG rotation direction (20-28) will be change automatically, please do motor tuning again by same items. If the same error happen again, please re-wire the feedback or motor phase sequence, then do motor tuning again.

- c) Next press the enter key to go to the PM motor tuning screen. The keypad will display the message of "IPrdy" (Ready to Tune).
- d) Press run to start the PM motor tuning. The keypad will display the "IPtun" message during auto-tune.
- e) If the motor is successfully tuned, the message of "IPEnd " will be displayed. If auto-tune is aborted with the stop key, the operator will display the message of " IPbrd "(PM motor tuning aborted).

#### **Notes:**

1. Perform a magnetic pole alignment auto-tune before adjusting the speed loop.
2. It is not required to perform a magnetic pole alignment auto-tune each time the inverter is powered up.

#### **22-22: Fault History of PM Motor Tuning**

If PM motor tuning has failed, the "IPErr" message is shown on the keypad (PM motor tuning failure). Refer to section 10 for the possible error causes and trouble shooting.

PM motor tuning fault history (22-22) only stores the result of the last auto-tune performed .If auto-tuning was successful or aborted, no error will be displayed.

#### **22-25: Detection Mode Selection of Initial Magnetic Pole**

Select the motor activation's rotor position detection method

Method 0: Do not detect rotor position, start by directly using the angle when the motor was previously stopped

Method 1: Use input pulse signal to detect rotor position.

Method 2: Use input continuous variable frequency signal to detect rotor position.

[Method 3: Input voltage pulse signal](#)

#### **22-26: High speed control ratio enable**

- It is suggested to set 22-26=0 when SPM motor is used. Inverter starts in I/f mode and the relevant adjustable parameters are 22-10 & 22-11.
- It is suggested to set 22-26=1 when IPM motor is used and speed control mode is performed by the speed control ratio 1:50. Inverter will input the continuously variable frequency signal to motor and the relevant adjustable parameters are 22-27 & 22-28.
- [When it is set to 2, both IPM motors and SPM motors can be used, and the relevant adjustable parameters are 22-42 to 22-45.](#)

#### **22-27: Voltage Command of Mode 2**

When 22-25=2 or setting of parameter 22-26 is enabled, input of the voltage amplitude setting for the continuously variable frequency signal will influence the motor jittering. When the motor starts and the rotor jitter occurs, it is required to increase the voltage amplitude to ensure the accuracy of detection angle.

**Note:** When the voltage value is set too high, overcurrent error may occur.

## 22-28: Divider Ratio of Mode 2

When 22-25=2 or setting of parameter 22-26 is enabled, the input of continuous signal frequency depends on the parameter (11-01) carrier setting. If the carrier setting is higher, it is required to appropriately increase the divider ratio so as to reduce the input of continuous signal frequency and ensure the accuracy of detection angle.

## 22-29: Flux-weakening Voltage Command Restriction

It is set for preventing the saturation of the output voltage. Inverter performs flux-weakening control by the percentage of input power supply voltage as the limit of output voltage command. If flux-weakening current command restriction (22-18) is set too low, inverter output voltage may exceed the voltage command limit.

<b>22-30</b>	<b>SPM Speed Estimation Gain</b>
<b>Range</b>	<b>【1 ~ 150】 %</b>
<b>22-31</b>	<b>SPM Speed Estimation Filter Value</b>
<b>Range</b>	<b>【1 ~ 2000】 Hz</b>
<b>22-32</b>	<b>MTPA Selection</b>
<b>Range</b>	<b>【0】 : Disabled 【1】 : Mode 1 【2】 : Mode 2 【3】 : Mode 3</b>
<b>22-33</b>	<b>MTPA Gain</b>
<b>Range</b>	<b>【0 ~ 400】 %</b>
<b>22-34</b>	<b>IPM Estimator Gain</b>
<b>Range</b>	<b>【1 ~ 180】 %</b>
<b>22-36</b>	<b>PM Motor Type Selection</b>
<b>Range</b>	0: Normal PM motor 1: DVEN Motor
<b>22-37</b>	<b>PM Motor Horse Power &amp; RPM</b>
<b>Range</b>	1: 0.75KW 1800RPM 4: 1.5KW 1800RPM 7: 2.2KW 1800RPM 10: 3.7KW 1800RPM 13: 5.5KW 1800RPM 16: 7.5KW 1800RPM 19: 11KW 1800RPM 22: 15KW 1800RPM 25: 18.5KW 1800RPM 28: 22KW 1800RPM

### 22-30: Speed Estimated Gain

### 22-31: Speed Estimated Filter Value

When Estimator Mode 22-26 set to 0, adjust the speed response performance, the higher the setting value, the faster the motor reacts, however, if the setting value is too high, the control object will generate vibrations and become unstable, also, if the setting value is lower, the speed deviation will increase. Please adjust to the appropriate setting value according to the field equipment.

### 22-32: MTPA Selection

- 0: MTPA invalid
- 1: Distribute D-Q-axis current command according to the torque command.
- 2: Distribute D-Q-axis current command according to the torque command and restrict output voltage (12-19) to below the motor's rated voltage (22-01).
- 3: Distribute D-Q-axis current command according to the torque command and control the output voltage (12-19) to around the motor's rated voltage (22-01).

### 22-33: MTPA Gain

When the default value is 200%, revising the PM motor's D-axis inductance (22-15) or Q-axis inductance (22-16) (such as completing the PM motor adjustment or directly changing the inductance value) will re-calculate the MTPA Gain (22-33).

### 22-34: IPM Estimator Gain

When the estimator mode (22-26) setting is 1, the estimator gain is the multiple of the bandwidth. The larger the setting value, the faster the motor response. However, if the value is too high, the control item will exhibit vibration and become unstable. The smaller the setting value, the greater the speed deviation. Please adjust the appropriate setting value according to the site equipment.

### 22-36: PM Motor Type Selection

### 22-37: PM Motor Horse Power & RPM

Use (22-36) to choose general PM motor or DVEN motor. After selecting, you can match the parameter PM motor horsepower and RPM (23-37), select the corresponding horsepower number, you can build the motor parameters without auto-tuning, if you choose general motor later, auto-tuning is required.

<b>22-38</b>	<b>Open and closed loop switching point frequency width (%)</b>
<b>Range</b>	<b>【1.0~40】%</b>
<b>22-39</b>	<b>Preliminary DC injection time</b>
<b>Range</b>	<b>【0.00~20.0】s</b>
<b>22-40</b>	<b>High frequency angle finding time</b>
<b>Range</b>	<b>【0.01~1.00】s</b>
<b>22-41</b>	<b>PM stop method</b>
<b>Range</b>	0: Decelerate or stop below 22-11 and brake directly 1: Decelerate or stop below 22-11 and open loop stop
<b>22-42</b>	<b>Fully closed loop control gain Ka</b>
<b>Range</b>	<b>【64~8192】</b>
<b>22-43</b>	<b>Fully closed loop control gain Kb</b>
<b>Range</b>	<b>【64~8192】</b>
<b>22-44</b>	<b>Fully closed loop control gain speed low pass filter</b>
<b>Range</b>	<b>【1~256】</b>
<b>22-45</b>	<b>Fully closed loop control magnetic flux</b>
<b>Range</b>	<b>【0.01~10.00】</b>

### 22-38: Open and closed loop switching point frequency width (%)

Mainly when 22-26 = 0, open-loop control, when the (22-11) I/F mode start frequency switching point is exceeded, the open-loop switch to the closed-loop control process, through the adjustment of the switching weight ratio, the switching process can be effectively suppressed the current stability may be caused by different applications,

which enables better effects and protection in control operation.

#### **22-39: Preliminary DC injection time**

When the PM motor starts, it will first estimate the angle and then run in the PMSLV mode. When this parameter is set, when the angle estimation is completed, the DC injection method will first be used to draw the motor to the angle before running, which can effectively achieve start-up stability.

#### **22-40: High frequency angle finding time**

When 22-25=2, due to the PM motor angle estimation through the high frequency method during startup, high frequency sound may be generated. In order to effectively suppress the high-frequency sound, users can use this parameter to set the high frequency angle finding time according to their needs. Set to reduce the high frequency sound generation by shortening the angle finding time when the high frequency angle search can be run normally.

#### **22-41: PM stop method**

In PMSLV mode, when the speed is lower than 22-11, the system will use the 22-41 parameter mode to perform different deceleration modes. When 22-41=0, the deceleration/stop is lower than 22-11 and the DC brake mode will stop. ; When 22-41=1, open loop stop when deceleration/stop is lower than 22-11. Users can choose between the modes according to their needs to achieve better operation control.

#### **22-42: Fully closed loop control gain Ka**

#### **22-43: Fully closed loop control gain Kb**

#### **22-44: Fully closed loop control gain speed low pass filter**

#### **22-45: Fully closed loop control magnetic flux**

Used with 22-26 = 2 full closed loop control, and full closed loop control is mainly used for control below the low speed control ratio to achieve PMSLV full-field full closed loop control, and then applied to different low-speed occasions, through adjustment and estimation the gain of parameters 22-42~45 of the device to achieves the stability of PMSLV low speed ratio control.

## 4.5 Built-in PLC Function



The PLC ladder logic can be created and downloaded using the TECO drive link software.



### 4.5.1 Basic Command





							NO / NC
Inputs					I	i	I1~I8 / i1~i8
Outputs	Q	Q	Q	Q	Q	q	Q1~Q2 / q1~q2
Auxiliary command	M	M	M	M	M	m	M1~MF / m1~mF
Special registers							V1~V7
Counter function	C				C	c	C1~C8 / c1~c8
Timer function	T				T	t	T1~T8 / t1~t8
Analog comparison function	G				G	g	G1~G8 / g1~g8
Operation control function	F				F	f	F1~F8 / f1~f8
summation and subtraction function	AS						AS1~4
Multiplication and division function	MD						MD1~4

#### Description of registers

V1: Set frequency	Range: 0.1~599.0Hz
V2: Operation frequency	Range: 0.1~599.0Hz
V3: AI1 input value	Range: 0~1000
V4: AI2 input value	Range: 0~1000
V5: Keypad input value	Range: 0~1000
V6: Operation current	Range: 0.1~999.9A
V7: Torque value	Range: 0.1~200.0%
V8: PID Target Value	Range: 0.1~599.0Hz

Command	Upper Differential	Lower Differential	Other command symbol
Differential command	D	d	
SET command			
RESET command			
P command			P

Open circuit		
Short circuit		

Connection symbol	Definition
	Connect components on the left and right side
	Connects components on the left , right and top side
	Connects components on the left , right , top and bottom side
	Connects components on the left , right and bottom side



## 4.5.2 Basic Command Function

### © D (d) command function

Example 1: I1-D —[ Q1

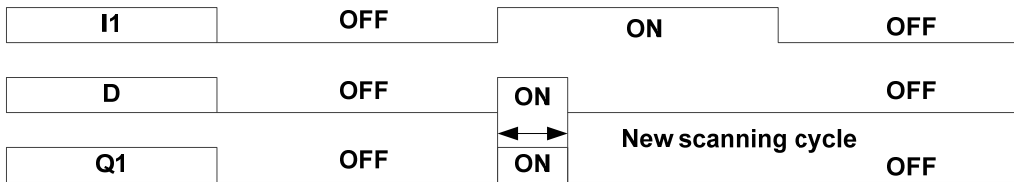

Example 2: i1-d —[ Q1

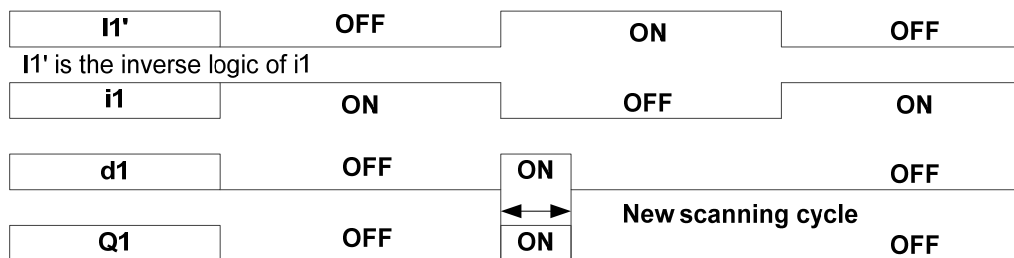

### © NORMAL( -[ ) output

I1—[Q1

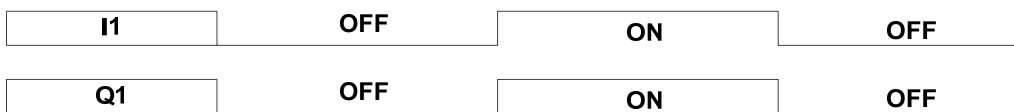

### © SET ( ^ ) output

I1— ^ Q1

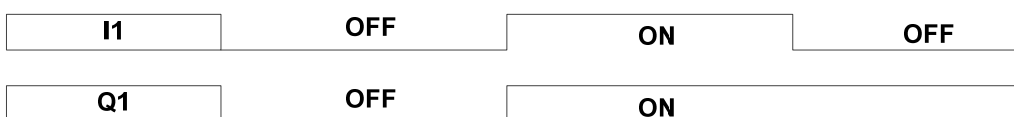

### © RESET ( v ) output

I1— v Q1

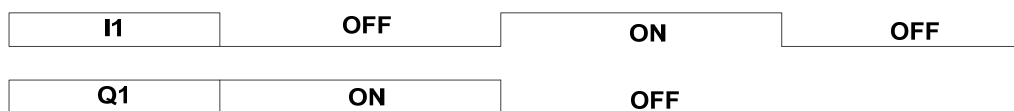

### © P output

i1—PQ1

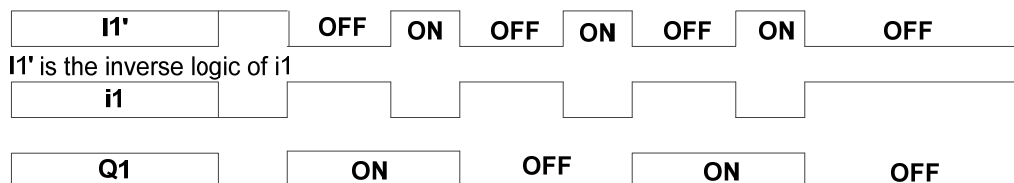

### 4.5.3 Application Functions

#### 1: Counter Function

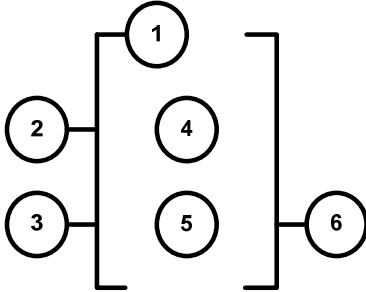

Symbol	Description
①	Counter mode (1 ~ 4)
②	UP/Down counting modes can be set by (I1 ~ f8). OFF: Count up (0, 1, 2, 3...) ON: Count down (...3,2,1,0)
③	Use (I1~f8) to reset counting value ON: Internal count value is reset and counter output ⑥ is OFF OFF: Internal counter value retained
④	Internal counter value
⑤	Counter compare value (AS1~AS4,MD1~MD4,T1~T8,C1~C8,V1~V7,constant)
⑥	Counter output (C1 to C8, there are a total of 8 counters)

#### Counter modes:

Mode 1: Counter value is locked to the set value. The value will not be retained when the power is cut off.

Mode 2: Counter value is not locked. The value will not be retained when the power is cut off.

Mode 3: Counter value is locked. The value will be retained when the power is cut off.

Mode 4: Counter value is not locked. The value will be retained when the power is cut off.

#### Counter mode 1

##### Example:

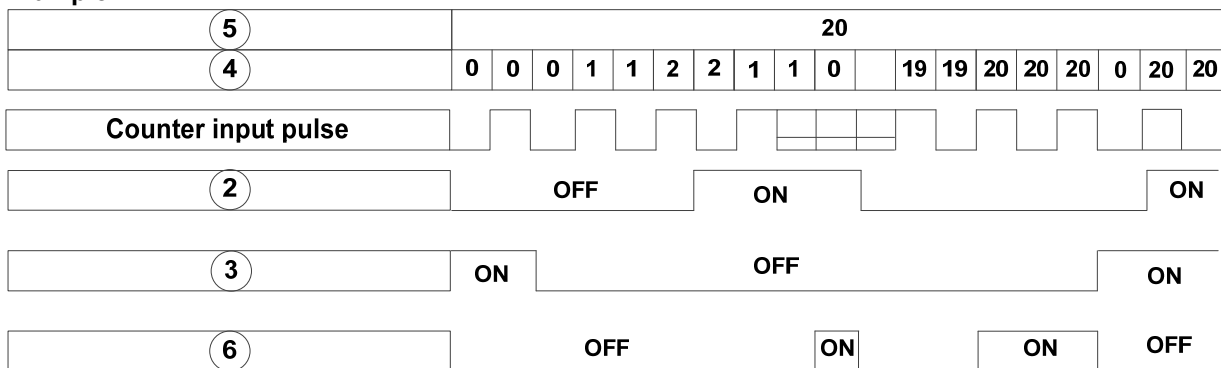

**Input from ladder program**

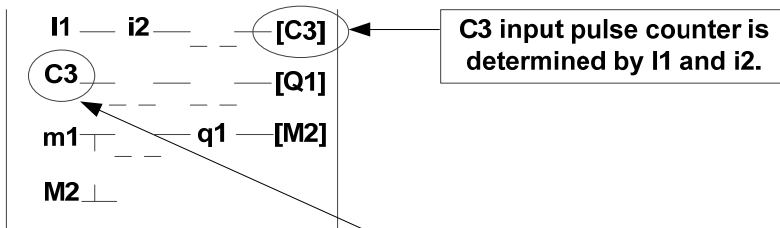

**Input from the function program**

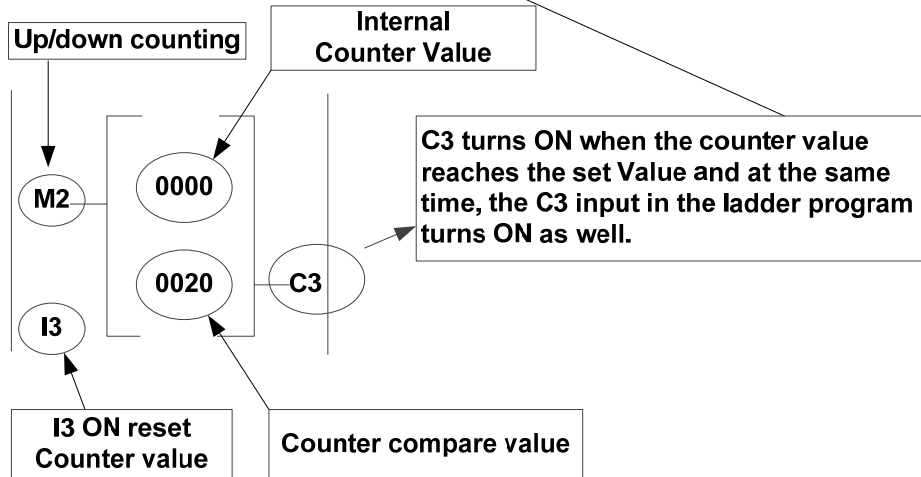

**Counter mode 2**

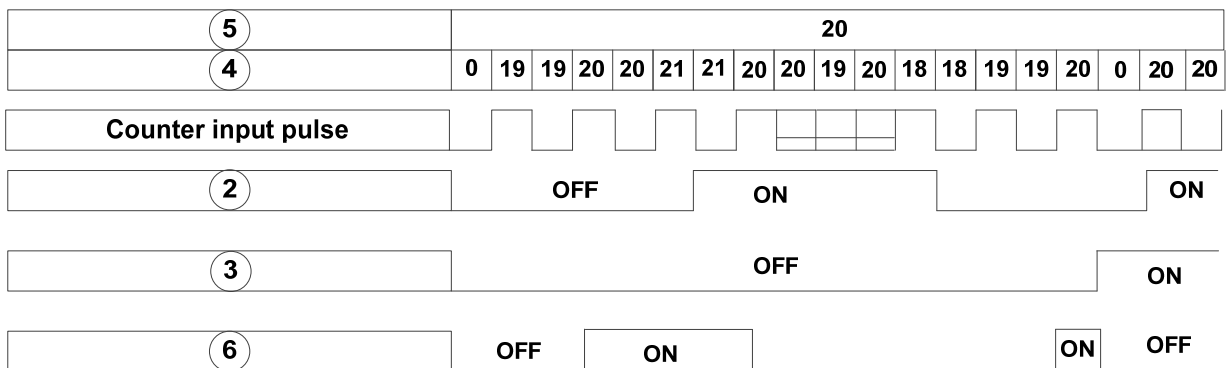

**Note:** In this mode the internal counter may increase past the counter compare value, unlike mode 1 where the internal counter value is limited to the counter compare value.

(1) Counter mode 3 is similar to the counter mode 1, with the exception that the counter value is saved when the drive is powered down and reloaded at power up.

(2) Counter mode 4 is similar to the counter mode 2, with the exception that the counter value is saved when the drive is powered down and reloaded at power up.

5		20												
4	Mode 1 & 2	1	1	2	2					0	1	1	2	2
4	Mode 3 & 4	1	1	2	2	3				3	4	4	5	5

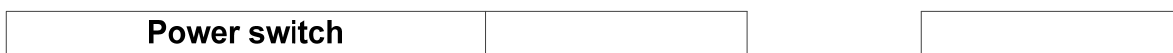

## 2: Timer Function

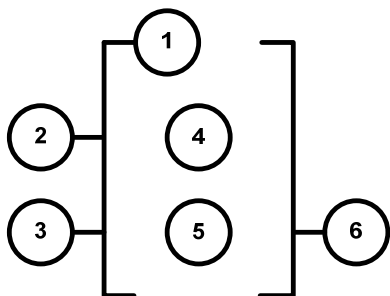

Symbol	Description
①	Timer mode (0-7)
②	Timing unit: 1: 0.0~999.9 second
	2: 0~9999 second
	3: 0~9999 minute
③	Use (I1~I8) to reset timing value
	ON: Internal timing value is reset and timer output ⑥ is OFF
	OFF: Internal timer stays running
④	Internal timer value
⑤	Timer set value (AS1~AS4, MD1~MD4, T1~T8, C1~C8, V1~V8, constant)
⑥	Timer output (T1 to T8, there are a total of 8 timers)

### Timer mode description:

#### (1) Timer mode 0 (ON-RTC mode)

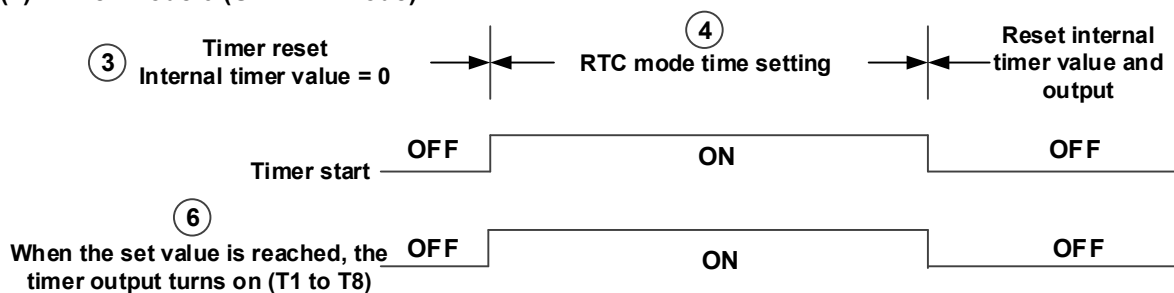

#### (2) Timer mode 1 (ON-delay Timer mode 1)

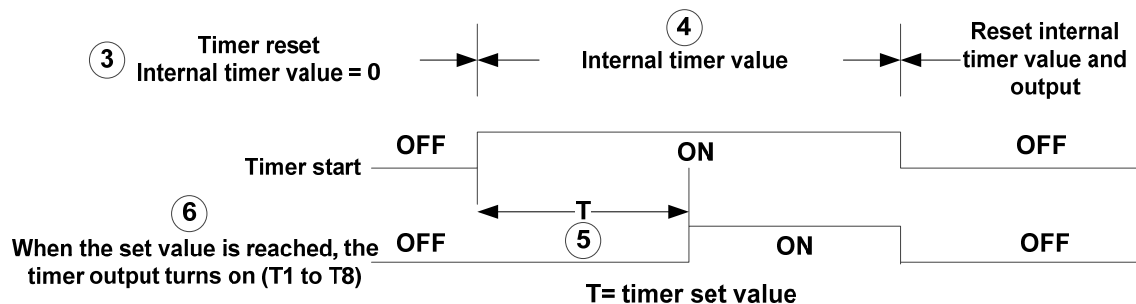

**Example:**

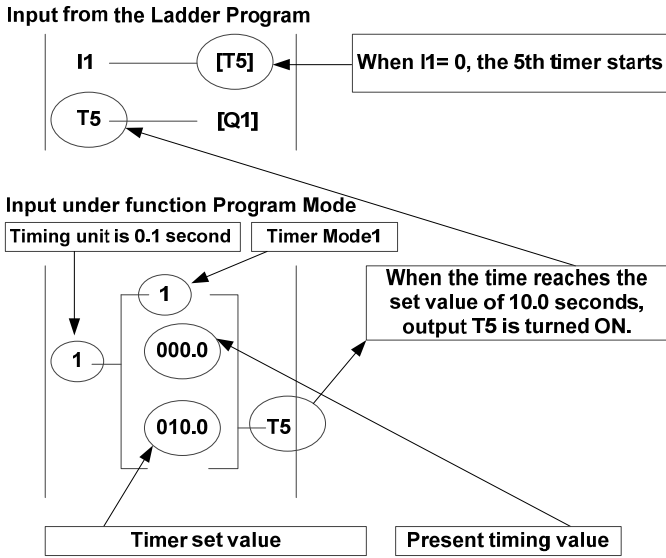

**(3) Timer mode 2 (ON-delay Timer mode 2)**

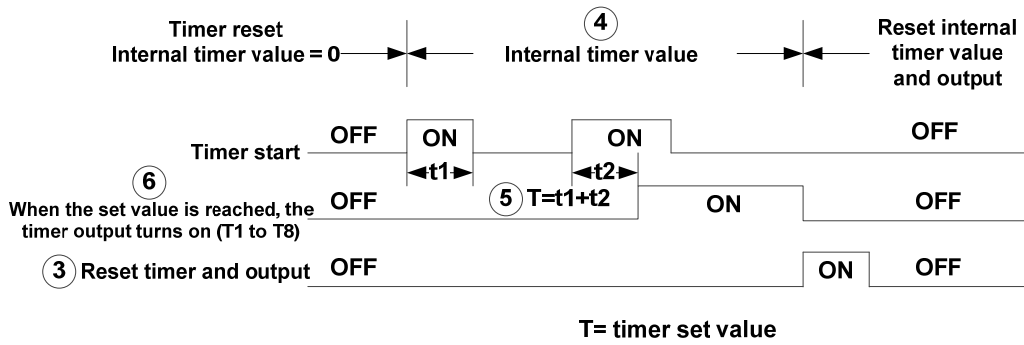

**(4) Timer mode 3 (OFF-delay Timer mode 1)**

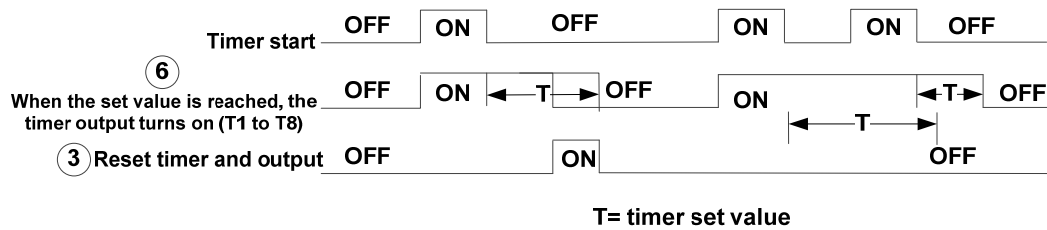
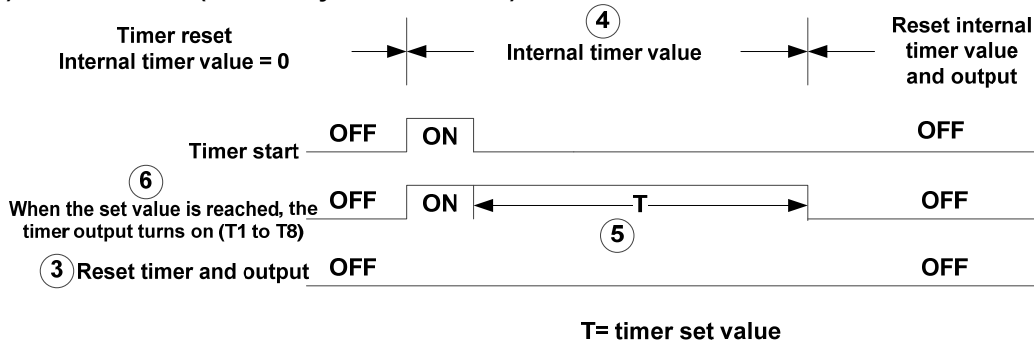

**(5) Timer mode 4 (OFF-delay Timer mode 2)**

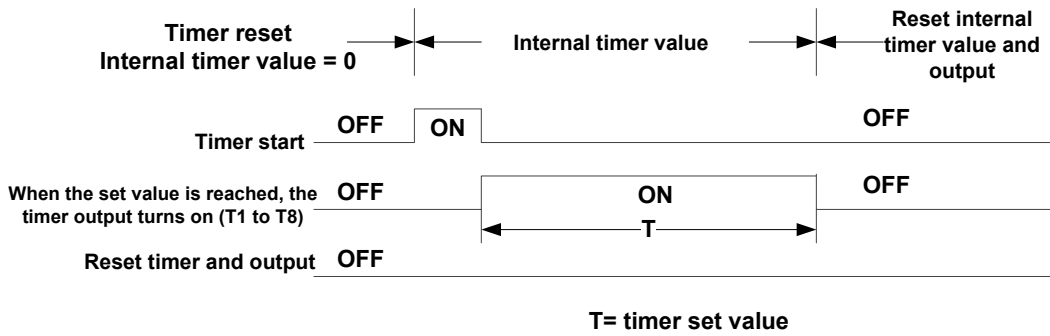

**(6) Timer mode 5 (FLASH Timer mode 1)**

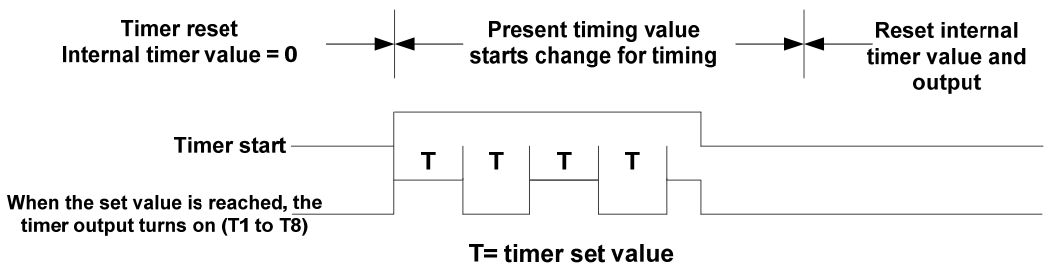

**(7) Timer mode 6 (FLASH Timer mode 2)**

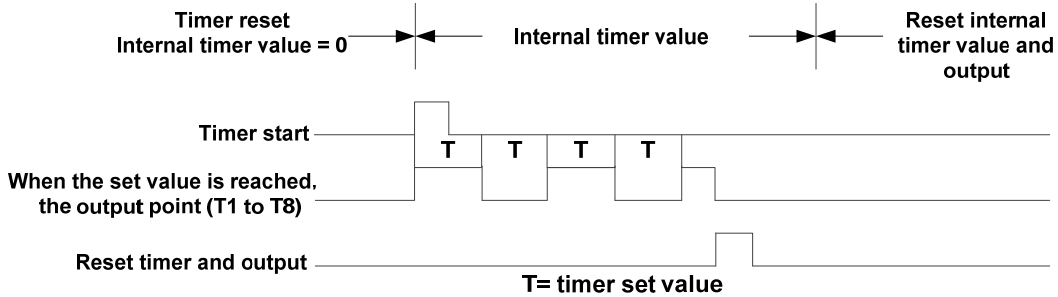

**(8) Timer mode 7 (FLASH Timer mode 3)**

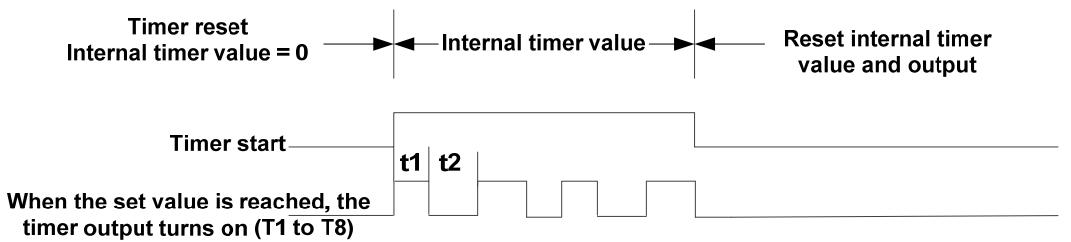

### 3: Analog comparator function

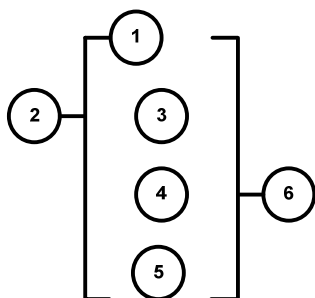

Symbol	Description
①	Analog comparator mode (1~3)
②	Input comparison value selection (AS1~AS4,MD1~MD4,T1~T8,C1~C8,V1~V8)
③	Current analog input value
④	Set the reference comparison value (Upper limit) (AS1~AS4,MD1~MD4,T1~T8,C1~C8,V1~V8, constant )
⑤	Set the reference comparison value (lower limit) (AS1~AS4,MD1~MD4,T1~T8,C1~C8,V1~V8, constant )
⑥	Comparator output (G1 to G8, there are a total of 8 comparators)

#### The description of analog comparison mode:

- (1) Analog comparison mode 1 (③ ≤ ⑤, ⑥ ON)
- (2) Analog comparison mode 2 (③ ≥ ④, ⑥ ON)
- (3) Analog comparison mode 3 (⑤ ≤ ③ ≤ ④, ⑥ ON)

#### Input comparison value selection (V1~V7)

- (1) Input comparison value selection = V1: Set frequency
- (2) Input comparison value selection = V2: Operation frequency
- (3) Input comparison value selection = V3: AI1 input value
- (4) Input comparison value selection = V4: AI2 input value
- (5) Input comparison value selection = V5: Keypad input value
- (6) Input comparison value selection = V6: Operation current
- (7) Input comparison value selection = V7: Torque value
- (8) Input comparison value selection = V8: PID Target Value



#### 4: Operation control function

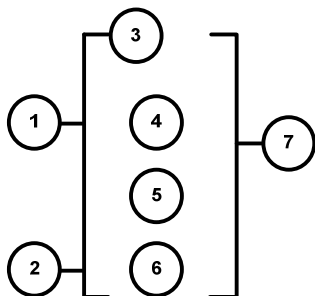

Symbol	Description
①	Forward /Reversal control can be set by ( I1~f8 ) OFF: Forward(FWD) ON: Reversal(REV)
②	Speed terminal control can be set by ( I1~f8 ) OFF: Operation based on ③ set frequency ON: Operation based on frequency of speed ④
③	Set frequency (can be constant or V3、 V4、 V5 · V8 )
④	Speed frequency (can be constant or V3、 V4、 V5 · V8)
⑤	Acceleration time (ACC Time)
⑥	Deceleration time (DEC Time)
⑦	Operation command output (F1 to F8, there are a total of 8 operation control functions)

#### Example:

##### Input from the Ladder Program

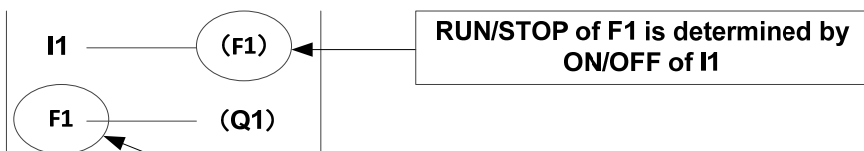

##### Input from Function Program

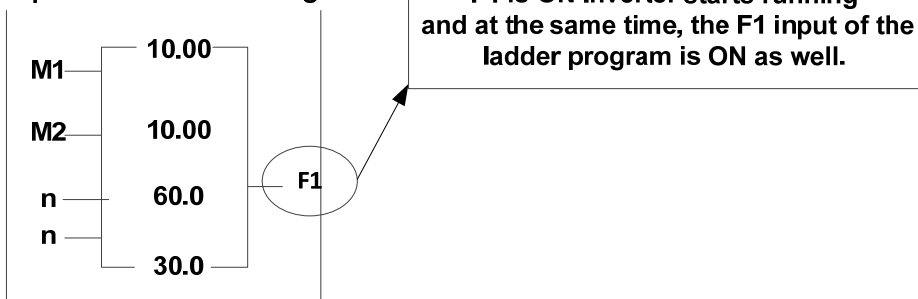

## 5: Summation and subtraction functions

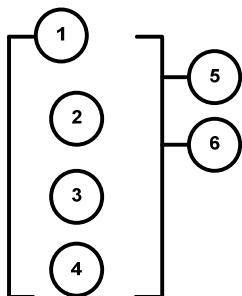

RESULT (calculation result) = V1+ V2- V3

Symbol	Description
①	Calculation result : RESULT
②	Addend V1(AS1~AS4,MD1~MD4,T1~T8,C1~C8,V1~V8, constant )
③	Addend V2(AS1~AS4,MD1~MD4,T1~T8,C1~C8,V1~V8, constant )
④	Subtrahend V3(AS1~AS4,MD1~MD4,T1~T8,C1~C8,V1~V8, constant )
⑤	Coil output of error signal (M1~MF)
⑥	Addition and subtraction modes number (AS1~AS4)

## 6: Multiplication and division modes

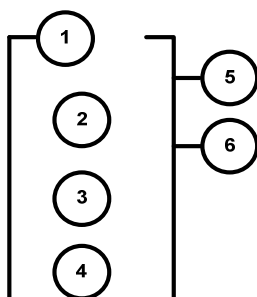

RESULT (calculation result) =V1\*V2/V3

Symbol	Description
①	Calculation result : RESULT
②	Multiplier V1(AS1~AS4,MD1~MD4,T1~T8,C1~C8,V1~V8, constant )
③	Multiplier V2(AS1~AS4,MD1~MD4,T1~T8,C1~C8,V1~V8, constant )
④	Divisor V3(AS1~AS4,MD1~MD4,T1~T8,C1~C8,V1~V8, constant )
⑤	Coil output of error signal (M1~MF)
⑥	Multiplication and division modes number (MD1~ MD4)

## 4.6 Modbus Protocol Descriptions

### 4.6.1 Communication Connection and Data Frame

The inverter can communicate with a PC or PLC via RS485 or RS232 using the Modbus RTU or Modbus ACSII protocol. The maximum frame length is 80 bytes.

#### Network Connection

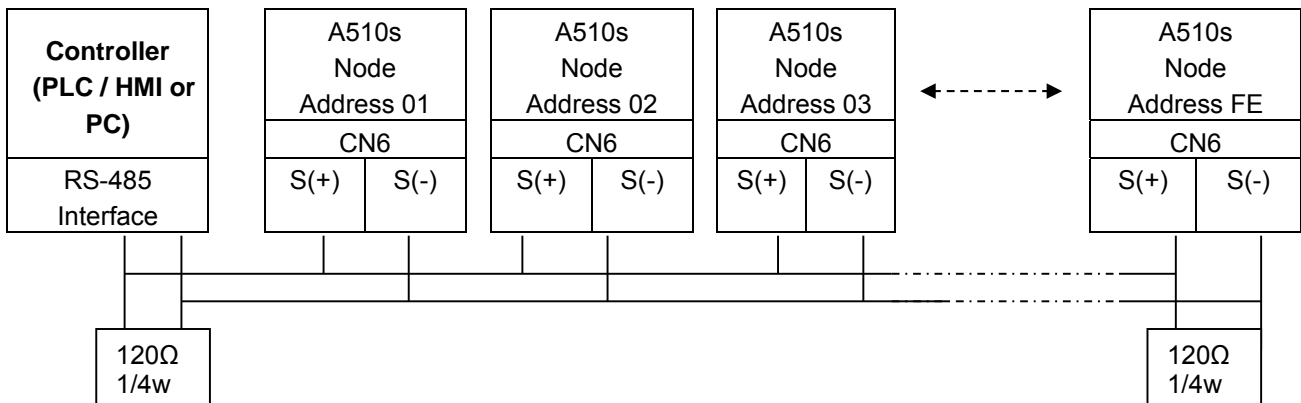

**\*\* Terminate the communications line with a (120 ohm, 1/4 watt) resistor at both ends.**

**CN6 Pin out**

PIN	Signal	PIN	Signal
1	RS-485 S+ signal	5	Tx signal
2	RS-485 S- signal	6	RS-485 S- signal
3	RS-485 S+ signal	7	VCC of isolated 5V power supply
4	Rx signal	8	GND of isolated 5V power supply

For RS-485 communication use pin 1 or pin 3 for S (+) and pin 2 or pin 6 for S (-)

## Data Format Frame

### Data Frame for ASCII Mode

STX(3AH)	Start Bit = 3AH
Node Address Hi	Communication Address(Station):
Node Address Lo	
Function Hi	Function Code (command):
Function Lo	
Command Start Address	Command Start byte:
Command Start Address	
Command Start Address	
Command Start Address	
Data length	The length of the command:
Data length	
Data length	
Data length	
LRC Check Hi	LRC Check Code:
LRC Check Lo	
END Hi	End Byte:
END Lo	

### Data Frame for RTU Mode

Master (PLC etc.) sends request to follower (inverter), and the follower sends a response to the master (PC, PLC). The data received is illustrated here.

The data length varies depending on the command (Function).

Node Address
Function Code
DATA
CRC CHECK
Signal Interval

\*\* The inverter response time is 10ms.

### Node Address

00H: Broadcast to all the drivers

01H: to the No. 01 inverter

0FH: to the No.15 inverter

10H: to the No.16 inverter and so on....., max to No.31 (1FH)

## Function Code

03H: Read the register contents

06H: Write a WORD to register

08H: Loop test

10H: Write several data to register (complex number register write)

## Checksum Calculation

### LRC

ex. NODE ADDRESS	01H
FUNCTION	03H
COMMAND	01H
	00H
+ DATA LENGTH	0AH
-----	
	0FH ----- 2's complement
Checksum	F1H
CS (H)	46H (ASCII)
CS (L) =	31H (ASCII)

### CRC

CRC Check: CRC code covers the content from node address to DATA. Please calculate it according to the following methods.

- (1) Load a 16-bit register with FFFF hex (all 1's). Call this CRC register.
- (2) Exclusive OR the first 8-bit byte of the message, the low-order byte of the 16-bit CRC register, putting the result in the CRC register.
- (3) Shift the CRC register one bit to the right (toward the LSB), Zero-filling the MSB, Extract and examines the LSB.
- (4) (If the LSB was 0): Repeat Steps (3) (another shift)  
(If the LSB was 1): Exclusive OR the CRC register with the polynomial value A001 hex (1010 0000 0000 0001), putting the result in CRC register.
- (5) Repeat Steps (3) and (4) until 8 shifts been performed. When this is done, a complete 8-bit byte will be processed.
- (6) Repeat Steps (2) through (5) for next 8-bit byte of the message, Continue doing this until all bytes have been processed. The final content in the CRC register is the CRC value. When sending the CRC value, the Low-order byte should be sent firstly, then the High-order byte. For example, CRC value: 1241 Hex, the high-order byte should be set to 41hex and low-order byte 12hex.

**CRC calculate program (C language):**

```

UWORD ch_sum (UBYTE long, UBYTE *rxdbuf )
{
    BYTE i = 0;
    UWORD wkg = 0xFFFF;
    while ( long-- ) {
        wkg ^= rxdbuf++;
        for ( i = 0 ; i < 8; i++ ) {
            if ( wkg & 0x0001 ) {
                wkg = ( wkg >> 1 ) ^ 0xa001;
            }
            else {
                wkg = wkg >> 1;
            }
        }
    }
    return( wkg );
}

```

ASCII Mode	
STX	‘:’
Address	‘0’
	‘1’
Function	‘8’
	‘6’
Exception code	‘5’
	‘1’
LRC Check	‘2’
	‘8’
END	‘CR’
	‘LF’

RTU Mode		
Node Address		02H
Function		83H
Exception code		52H
CRC-16	High	C0H
	Low	CDH

During a communication error the drive will response with an Exception Code and send a message back to the main system consisting of a Function Code that is “ANDED (and 80h)” with 80 Hex.

Exception code	Content
01	Function code error
02	Register number error
03	DATA setting error
04	Register number is over 32

## 4.6.2 Register and Data Format

### Command Data (Read / Write)

Register No.	Bit	Content
2500H	Reserved	
2501H	0	Operation Command 1 : Run 0 : Stop
	1	Reverse Command 1 : Reverse 0 : Forward
	2	External Fault 1 : Fault
	3	Fault Reset 1 : Reset
	4	Reserved
	5	Reserved
	6	Multi-function Comm S1 1 : "ON"
	7	Multi-function Comm S2 1 : "ON"
	8	Multi-function Comm S3 1 : "ON"
	9	Multi-function Comm S4 1 : "ON"
	A	Multi-function Comm S5 1 : "ON"
	B	Multi-function Comm S6 1 : "ON"
	C	Multi-function Comm S7 1 : "ON"
	D	Multi-function Comm S8 1 : "ON"
E	Inverter mode 1 : "ON"	
F	Torque Command set by Communication 1 : "ON"	
2502H	*Frequency Command (Unit: 0.01Hz)	
2503H	Torque Command (+/-8192 corresponding to the rated torque +/-100%)	
2504H	Speed limit (+/- 120 corresponding +/-120%)	
2505H	AO1 (0.00V ~ 10.00V)	
2506H	AO2 (0 ~ 1000): Voltage (corresponding to 0.00~10.00V); Current ( corresponding to 4mA~20mA)	
2507H	DO	
2508H	Reserved	
2509H	Reserved	
250AH	Reserved	
250BH	Reserved	
250CH	Reserved	
250DH	Reserved	
250EH	Reserved	
250FH	Reserved	
2510H	G12-00 H-WORD	
2511H	G12-00 L-WORD	

**Note:** Write in zero for Not used BIT, do not write in data for the reserved register.

**\*\* If the maximum output frequency of motor is over 300HZ, the frequency resolution is changed to 0.1Hz**

**Monitor Data (Read-only)**

Register No.	Bit	Content		
2520H	0	Operation	1 : Run      0 : Stop	
	1	Direction	1 : Reverse    0 : Forward	
	2	Inverter ready	1 : ready      0 : unready	
	3	Fault	1 : Abnormal	
	4	Warning	1 : "ON"	
	5	Zero Speed	1 : "ON"	
	6	Is440V	1 : "ON"	
	7	Frequency Agree	1 : "ON"	
	8	Set Frequency Agree	1 : "ON"	
	9	Frequency Detection 1	1 : "ON"	
	A	Frequency Detection 2	1 : "ON"	
	B	Under Voltage	1 : "ON"	
	C	Baseblock	1 : "ON"	
	D	Freq Ref. not from Comm.	1 : "ON"	
	E	Seq. not from Comm.	1 : "ON"	
	F	Over Torque	1 : "ON"	
2521H	0		30	
	1	UV	31	
	2	OC	32	
	3	OV	33	
	4	OH1	34	
	5	OL1	35	
	6	OL2	36	
	7	OT	37	
	8	UT	38	CF07
	9	SC	39	
	10	Ground OC	40	
	11	Fuse broken	41	OLDOP
	12	Input Phase Loss	42	
	13	Output Phase Loss	43	
	14	PG Overspeed	44	
	15	PG Open	45	
	16	PG Speed Deviation	46	
	17	External Fault 01	47	SS1
	18	External Fault 02	48	CF20
	19	External Fault 03	49	RUN
	20	External Fault 04	50	OCA
	21	External Fault 05	51	OCD
	22	External Fault 06	52	OCC
	23	External Fault 07	53	CF08
	24	External Fault 08	54	
	25	FB	55	PF (Protection Fault)
	26	OPR	56	TOL (External Overload)
	27		57	



		28	CE			58			
		29	STO			59			
		30	Over Torque 2			61			
2522H	DI State	0	Terminal S1						
		1	Terminal S2						
		2	Terminal S3						
		3	Terminal S4						
		4	Terminal S5						
		5	Terminal S6						
		6	Terminal S7						
		7	Terminal S8						
		8	Reserved						
		9	Reserved						
		A	Reserved						
		B	Reserved						
		C	Reserved						
		D	Reserved						
		E	Reserved						
F	Reserved								
2523H		Frequency command (0.01Hz)							
2524H		Output frequency (0.01Hz)							
2525H		Reserved							
2526H		DC voltage command (0.1V)							
2527H		Output current (0.1A)							
2528H	Warning Description	0	No alarm	20	EF4	40	EF	60	Reserved
		1	OV	21	EF5	41	Reserved	61	RETRY
		2	UV	22	EF6	42	Reserved	62	SE07
		3	OL2	23	EF7	43	RDP	63	SE08
		4	OH2	24	EF8	44	Reserved	64	Reserved
		5	Reserved	25	Reserved	45	OL1	65	OH1
		6	OT	26	CLB	46	HP_ER	66	FIRE
		7	Reserved	27	Reserved	47	SE10	67	ES
		8	Reserved	28	CT	48	保留	68	STP1
		9	UT	29	USP	49	BB1	69	BDERR
		10	OS	30	RDE	50	BB2	70	EPERR
		11	PGO	31	WRE	51	BB3	71	ADCER
		12	DEV	32	FB	52	BB4	72	Reserved
		13	CE	33	VRYE	53	BB5	73	STP0
		14	CALL	34	SE01	54	BB6	74	ENC
		15	Reserved	35	SE02	55	BB7	75	STP2
		16	EF0	36	SE03	56	BB8	76	RUNER
		17	EF1	37	Reserved	57	Reserved	77	LOC
		18	EF2	38	SE05	58	Reserved		
19	EF3	39	HPERR	59	Reserved				
2529H		Digital Output State							
252AH		AO1 (0.00V ~ 10.00V)							

252BH		AO2 (0 ~ 1000): Voltage (corresponding to 0.00~10.00V); Current (corresponding to 4mA~20mA)
252CH		Analog Input 1 (0.1%)
252DH		Analog Input 2 (0.1%)
252EH		Reserved
252FH		L510(s)/ E510(s)/ A510(s)/ F510 Check

**Note:** Write in zero for Not used BIT, do not write in data for the reserved register.

\* If the maximum output frequency of motor is over 300HZ, the frequency resolution is changed to 0.1Hz

## Read Holding Register [03H]

Read consecutive holding registers. The address of the first holding register is specified in the protocol  
 Example: Read frequency command from the inverter with node address 1.

### ASCII Mode

#### Command Message

3AH	STX
30H	Node Address
31H	
30H	Function
33H	
30H	Starting Register
31H	
32H	
33H	
30H	Number of Registers
30H	
30H	
31H	
?	LRC CHECK
?	
0DH	END
0AH	

#### Response Message (Normal)

3AH	STX
30H	Node Address
31H	
30H	Function
33H	
30H	Data Length
32H	
31H	Initial Save Register
37H	
37H	
30H	
?	LRC CHECK
?	
0DH	END
0AH	

#### Response Message (Error)

3AH	STX
30H	Node Address
31H	
38H	Function
33H	
30H	Exception code
34H	
34H	LRC CHECK
30H	
0DH	END
0AH	

### RTU Mode

#### Command Message

Node Address	01 H	
Function	03H	
Starting Register	High	0CH
	Low	10H
Number of Registers	High	00H
	Low	01H
CRC-16	High	86H
	Low	9FH

#### Response Message (Normal)

Node Address	01H	
Function	03H	
Data Length	02H	
Initial Save Register	High	17H
	Low	70H
CRC-16	High	B6H
	Low	50H

#### Response Message (Error)

Node Address	01H	
Function	83H	
Exception code	04H	
CRC-16	High	40H
	Low	F3H

### Loop back test [08H]

Check the communication between the master and the follower (inverter). The data used can be arbitrary.

### ASCII Mode

#### Command Message

3AH	STX
30H	Node Address
31H	
30H	Function
38H	
30H	Test Code
30H	
30H	
30H	
41H	DATA
35H	
33H	
37H	
31H	LRC CHECK
42H	
0DH	END
0AH	

#### Response Message (Normal)

3AH	STX
30H	Node Address
31H	
30H	Function
38H	
30H	Test Code
30H	
30H	
30H	
41H	DATA
35H	
33H	
37H	
31H	LRC CHECK
42H	
0DH	END
0AH	

#### Response Message (Error)

3AH	STX
30H	Node Address
31H	
38H	Function
38H	
30H	Exception code
33H	
30H	LRC CHECK
36H	
0DH	END
0AH	

### RTU Mode

#### Command Message

Node Address	01 H	
Function	08H	
Test Code	High	00H
	Low	00H
DATA	High	A5H
	Low	37H
CRC-16	High	DAH
	Low	8DH

#### Response Message (Normal)

Node Address	01H	
Function	08H	
Test Code	High	00H
	Low	00H
DATA	High	A5H
	Low	37H
CRC-16	High	DAH
	Low	8DH

#### Response Message (Error)

Node Address	01H	
Function	88H	
Exception code	03H	
CRC-16	High	06H
	Low	01H

### Write Single Holding Register [06H]

Write single holding register. The register address of the holding register is specified in the message.

**Example:** Write a 60.00Hz frequency command to node address 1.

#### ASCII Mode

##### Command Message

3AH	STX
30H	Node Address
31H	
30H	Function
36H	
32H	Starting Register
35H	
30H	
32H	
31H	DATA
37H	
37H	
30H	
34H	LRC CHECK
42H	
0DH	END
0AH	

##### Response Message (Normal)

3AH	STX
30H	Node Address
31H	
30H	Function
36H	
32H	Starting Register
35H	
30H	
32H	
31H	DATA
37H	
37H	
30H	
34H	LRC CHECK
42H	
0DH	END
0AH	

##### Response Message (Error)

3AH	STX
30H	Node Address
31H	
38H	Function
36H	
30H	Exception code
33H	
30H	LRC CHECK
32H	
0DH	END
0AH	

#### RTU Mode

##### Command Message

Node Address	01 H	
Function	06H	
Start No	High	25H
	Low	02H
DATA	High	17H
	Low	70H
CRC-16	High	2DH
	Low	12H

##### Response Message (Normal)

Node Address	01H	
Function	06H	
Start No	High	25H
	Low	02H
DATA	High	17H
	Low	70H
CRC-16	High	2DH
	Low	12H

##### Response Message (Error)

Node Address	01H	
Function	86H	
Exception code	03H	
CRC-16	High	02H
	Low	61H

## Write Multiple Holding Register [10H]

Write multiple holding registers. The address of the first holding register is specified in the message.

**Example:** Write a 60.00Hz frequency command to node address 1 and enable FWD run command.

### ASCII Mode

#### Command Message

3AH	STX
30H	Node Address
31H	
31H	Function
30H	
30H	Starting Register
31H	
30H	
31H	
30H	Number of Registers
30H	
30H	
32H	
30H	Number of Bytes*
34H	
30H	DATA 1
30H	
30H	
31H	
31H	DATA 2
37H	
37H	
30H	
33H	LRC CHECK
42H	
0DH	END
0AH	

#### Response Message (Normal)

3AH	STX
30H	Node Address
31H	
31H	Function
30H	
32H	Starting Register
35H	
30H	
31H	
30H	Number of Registers
30H	
30H	
32H	
43H	LRC CHECK
37H	
0DH	END
0AH	

#### Response Message (Error)

3AH	STX
30H	Node Address
31H	
39H	Function
30H	
30H	Exception code
33H	
30H	LRC CHECK
43H	
0DH	END
0AH	

\* Number of bytes is register amount x 2

## RTU Mode

### Command Message

Node Address		01H
Function		10H
Starting Register	High	25H
	Low	01H
Number of Registers	High	00H
	Low	02H
Number of Bytes*		04H
DATA 1	High	00H
	Low	01H
DATA 2	High	17H
	Low	70H
CRC-16	High	60H
	Low	27H

### Response Message (Normal)

Node Address		01H
Function		10H
Starting Register	High	25H
	Low	01H
Number of Registers	High	00H
	Low	02H
CRC-16	High	1BH
	Low	04H

### Response Message (Error)

Node Address		01H
Function		90H
Exception code		03H
CRC-16	High	0CH
	Low	01H

\* Data amount is register amount x 2

### 4.6.3 Parameter Data

Function	Register No	Function	Register No	Function	Register No
<b>Group 0</b>		<b>Group 0</b>		<b>Group 1</b>	
0 – 00	0000H	0 – 43	002BH	1 – 00	0100H
0 – 01	0001H	0 – 44	002CH	1 – 01	0101H
0 – 02	0002H	0 – 45	002DH	1 – 02	0102H
0 – 03	0003H	0 – 46	002EH	1 – 03	0103H
0 – 04	0004H	0 – 47	002FH	1 – 04	0104H
0 – 05	0005H	0 – 48	0030H	1 – 05	0105H
0 – 06	0006H	0 – 49	0031H	1 – 06	0106H
0 – 07	0007H	0 – 50	0032H	1 – 07	0107H
0 – 08	0008H	0 – 51	0033H	1 – 08	0108H
0 – 09	0009H	0 – 52	0034H	1 – 09	0109H
0 – 10	000AH	0 – 53	0035H	1 – 10	010AH
0 – 11	000BH	0 – 54	0036H	1 – 11	010BH
0 – 12	000CH	0 – 55	0037H	1 – 12	010CH
0 – 13	000DH	0 – 56	0038H	1 – 13	010DH
0 – 14	000EH	0 – 57	0039H	1 – 14	010EH
0 – 15	000FH			1 – 15	010FH
0 – 16	0010H			1 – 16	0110H
0 – 17	0011H			1 – 17	0111H
0 – 18	0012H			1 – 18	0112H
0 – 19	0013H			1 – 19	0113H
0 – 20	0014H			1 – 20	0114H
0 – 21	0015H			1 – 21	0115H
0 – 22	0016H			1 – 22	0116H
0 – 23	0017H			1 – 23	0117H
0 – 24	0018H			1 – 24	0118H
0 – 25	0019H			1 – 25	0119H
0 – 26	001AH			1 – 26	011AH
0 – 27	001BH				
0 – 28	001CH				
0 – 29	001DH				
0 – 30	001EH				
0 – 31	001FH				
0 – 32	0020H				
0 – 33	0021H				
0 – 34	0022H				
0 – 35	0023H				
0 – 36	0024H				
0 – 37	0025H				
0 – 38	0026H				
0 – 39	0027H				
0 – 40	0028H				
0 – 41	0029H				
0 – 42	002AH				



Function	Register No	Function	Register No	Function	Register No	Function	Register No
<b>Group 2</b>		<b>Group 3</b>		<b>Group 3</b>		<b>Group 4</b>	
2 – 00	0200H	3 – 00	0300H	3 – 43	032BH	4 – 00	0400H
2 – 01	0201H	3 – 01	0301H	3 – 44	032CH	4 – 01	0401H
2 – 02	0202H	3 – 02	0302H	3 – 45	032DH	4 – 02	0402H
2 – 03	0203H	3 – 03	0303H	3 – 46	032EH	4 – 03	0403H
2 – 04	0204H	3 – 04	0304H	3 – 47	032FH	4 – 04	0404H
2 – 05	0205H	3 – 05	0305H	3 – 48	0330H	4 – 05	0405H
2 – 06	0206H	3 – 06	0306H	3 – 49	0331H	4 – 06	0406H
2 – 07	0207H	3 – 07	0307H	3 – 50	0332H	4 – 07	0407H
2 – 08	0208H	3 – 08	0308H	3 – 51	0333H	4 – 08	0408H
2 – 09	0209H	3 – 09	0309H	3 – 52	0334H	4 – 09	0409H
2 – 10	020AH	3 – 10	030AH	3 – 53	0335H	4 – 10	040AH
2 – 11	020BH	3 – 11	030BH			4 – 11	040BH
2 – 12	020CH	3 – 12	030CH			4 – 12	040CH
2 – 13	020DH	3 – 13	030DH			4 – 13	040DH
2 – 14	020EH	3 – 14	030EH			4 – 14	040EH
2 – 15	020FH	3 – 15	030FH			4 – 15	040FH
2 – 16	0210H	3 – 16	0310H			4 – 16	0410H
2 – 17	0211H	3 – 17	0311H			4 – 17	0411H
2 – 18	0212H	3 – 18	0312H			4 – 18	0412H
2 – 19	0213H	3 – 19	0313H			4 – 19	0413H
2 – 20	0214H	3 – 20	0314H			4 – 20	0414H
2 – 21	0215H	3 – 21	0315H				
2 – 22	0216H	3 – 22	0316H				
2 – 23	0217H	3 – 23	0317H				
2 – 24	0218H	3 – 24	0318H				
2 – 25	0219H	3 – 25	0319H				
2 – 26	021AH	3 – 26	031AH				
2 – 27	021BH	3 – 27	031BH				
2 – 28	021CH	3 – 28	031CH				
2 – 29	021DH	3 – 29	031DH				
2 – 30	021EH	3 – 30	031EH				
2 – 31	021FH	3 – 31	031FH				
2 – 32	0220H	3 – 32	0320H				
2 – 33	0221H	3 – 33	0321H				
2 – 34	0222H	3 – 34	0322H				
2 – 35	0223H	3 – 35	0323H				
2 – 36	0224H	3 – 36	0324H				
2 – 37	0225H	3 – 37	0325H				
		3 – 38	0326H				
		3 – 39	0327H				
		3 – 40	0328H				
		3 – 41	0329H				
		3 – 42	032AH				

Function	Register No	Function	Register No	Function	Register No	Function	Register No
<b>Group 5</b>		<b>Group 5</b>		<b>Group 6</b>		<b>Group 6</b>	
5 – 00	0500H	5 – 33	0521H	6 – 00	0600H	6 – 33	0621H
5 – 01	0501H	5 – 34	0522H	6 – 01	0601H	6 – 34	0622H
5 – 02	0502H	5 – 35	0523H	6 – 02	0602H	6 – 35	0623H
5 – 03	0503H	5 – 36	0524H	6 – 03	0603H	6 – 36	0624H
5 – 04	0504H	5 – 37	0525H	6 – 04	0604H	6 – 37	0625H
5 – 05	0505H	5 – 38	0526H	6 – 05	0605H	6 – 38	0626H
5 – 06	0506H	5 – 39	0527H	6 – 06	0606H	6 – 39	0627H
5 – 07	0507H	5 – 40	0528H	6 – 07	0607H	6 – 40	0628H
5 – 08	0508H	5 – 41	0529H	6 – 08	0608H	6 – 41	0629H
5 – 09	0509H	5 – 42	052AH	6 – 09	0609H	6 – 42	062AH
5 – 10	050AH	5 – 43	052BH	6 – 10	060AH	6 – 43	062BH
5 – 11	050BH	5 – 44	052CH	6 – 11	060BH	6 – 44	062CH
5 – 12	050CH	5 – 45	052DH	6 – 12	060CH	6 – 45	062DH
5 – 13	050DH	5 – 46	052EH	6 – 13	060DH	6 – 46	062EH
5 – 14	050EH	5 – 47	052FH	6 – 14	060EH	6 – 47	062FH
5 – 15	050FH	5 – 48	0530H	6 – 15	060FH		
5 – 16	0510H			6 – 16	0610H		
5 – 17	0511H			6 – 17	0611H		
5 – 18	0512H			6 – 18	0612H		
5 – 19	0513H			6 – 19	0613H		
5 – 20	0514H			6 – 20	0614H		
5 – 21	0515H			6 – 21	0615H		
5 – 22	0516H			6 – 22	0616H		
5 – 23	0517H			6 – 23	0617H		
5 – 24	0518H			6 – 24	0618H		
5 – 25	0519H			6 – 25	0619H		
5 – 26	051AH			6 – 26	061AH		
5 – 27	051BH			6 – 27	061BH		
5 – 28	051CH			6 – 28	061CH		
5 – 29	051DH			6 – 29	061DH		
5 – 30	051EH			6 – 30	061EH		
5 – 31	051FH			6 – 31	061FH		
5 – 32	0520H			6 – 32	0620H		

Function	Register No	Function	Register No	Function	Register No	Function	Register No
<b>Group 7</b>		<b>Group 7</b>		<b>Group 8</b>		<b>Group 8</b>	
7 – 00	0700H	7 – 41	0729H	8 – 00	0800H	8 – 41	0829H
7 – 01	0701H	7 – 42	072AH	8 – 01	0801H	8 – 42	082AH
7 – 02	0702H	7 – 43	072BH	8 – 02	0802H	8 – 43	082BH
7 – 03	0703H	7 – 44	072CH	8 – 03	0803H	8 – 44	082CH
7 – 04	0704H	7 – 45	072DH	8 – 04	0804H	8 – 45	082DH
7 – 05	0705H	7 – 46	072EH	8 – 05	0805H	8 – 46	082EH
7 – 06	0706H			8 – 06	0806H	8 – 47	082FH
7 – 07	0707H			8 – 07	0807H	8 – 48	0830H
7 – 08	0708H			8 – 08	0808H	8 – 49	0831H
7 – 09	0709H			8 – 09	0809H	8 – 50	0832H
7 – 10	070AH			8 – 10	080AH	8 – 51	0833H
7 – 11	070BH			8 – 11	080BH	8 – 52	0834H
7 – 12	070CH			8 – 12	080CH	8 – 53	0835H
7 – 13	070DH			8 – 13	080DH	8 – 54	0836H
7 – 14	070EH			8 – 14	080EH	8 – 55	0837H
7 – 15	070FH			8 – 15	080FH	8 – 56	0838H
7 – 16	0710H			8 – 16	0810H	8 – 57	0839H
7 – 17	0711H			8 – 17	0811H	8 – 58	083AH
7 – 18	0712H			8 – 18	0812H	8 – 59	083BH
7 – 19	0713H			8 – 19	0813H	8 – 60	083CH
7 – 20	0714H			8 – 20	0814H		
7 – 21	0715H			8 – 21	0815H		
7 – 22	0716H			8 – 22	0816H		
7 – 23	0717H			8 – 23	0817H		
7 – 24	0718H			8 – 24	0818H		
7 – 25	0719H			8 – 25	0819H		
7 – 26	071AH			8 – 26	081AH		
7 – 27	071BH			8 – 27	081BH		
7 – 28	071CH			8 – 28	081CH		
7 – 29	071DH			8 – 29	081DH		
7 – 30	071EH			8 – 30	081EH		
7 – 31	071FH			8 – 31	081FH		
7 – 32	0720H			8 – 32	0820H		
7 – 33	0721H			8 – 33	0821H		
7 – 34	0722H			8 – 34	0822H		
7 – 35	0723H			8 – 35	0823H		
7 – 36	0724H			8 – 36	0824H		
7 – 37	0725H			8 – 37	0825H		
7 – 38	0726H			8 – 38	0826H		
7 – 39	0727H			8 – 39	0827H		
7 – 40	0728H			8 – 40	0828H		

Function	Register No	Function	Register No	Function	Register No	Function	Register No
<b>Group 9</b>		<b>Group 10</b>		<b>Group 10</b>		<b>Group 11</b>	
9 – 00	0900H	10 – 00	0A00H	10 – 44	0A2CH	11 – 00	0B00H
9 – 01	0901H	10 – 01	0A01H	10 – 45	0A2DH	11 – 01	0B01H
9 – 02	0902H	10 – 02	0A02H	10 – 46	0A2EH	11 – 02	0B02H
9 – 03	0903H	10 – 03	0A03H	10 – 47	0A2FH	11 – 03	0B03H
9 – 04	0904H	10 – 04	0A04H	10 – 48	0A30H	11 – 04	0B04H
9 – 05	0905H	10 – 05	0A05H	10 – 49	0A31H	11 – 05	0B05H
9 – 06	0906H	10 – 06	0A06H			11 – 06	0B06H
9 – 07	0907H	10 – 07	0A07H			11 – 07	0B07H
9 – 08	0908H	10 – 08	0A08H			11 – 08	0B08H
9 – 09	0909H	10 – 09	0A09H			11 – 09	0B09H
		10 – 10	0A0AH			11 – 10	0B0AH
		10 – 11	0A0BH			11 – 11	0B0BH
		10 – 12	0A0CH			11 – 12	0B0CH
		10 – 13	0A0DH			11 – 13	0B0DH
		10 – 14	0A0EH			11 – 14	0B0EH
		10 – 15	0A0FH			11 – 15	0B0FH
		10 – 16	0A10H			11 – 16	0B10H
		10 – 17	0A11H			11 – 17	0B11H
		10 – 18	0A12H			11 – 18	0B12H
		10 – 19	0A13H			11 – 19	0B13H
		10 – 20	0A14H			11 – 20	0B14H
		10 – 21	0A15H			11 – 21	0B15H
		10 – 22	0A16H			11 – 22	0B16H
		10 – 23	0A17H			11 – 23	0B17H
		10 – 24	0A18H			11 – 24	0B18H
		10 – 25	0A19H			11 – 25	0B19H
		10 – 26	0A1AH			11 – 26	0B1AH
		10 – 27	0A1BH			11 – 27	0B1BH
		10 – 28	0A1CH			11 – 28	0B1CH
		10 – 29	0A1DH			11 – 29	0B1DH
		10 – 30	0A1EH			11 – 30	0B1EH
		10 – 31	0A1FH			11 – 31	0B1FH
		10 – 32	0A20H			11 – 32	0B20H
		10 – 33	0A21H			11 – 33	0B21H
		10 – 34	0A22H			11 – 34	0B22H
		10 – 35	0A23H			11 – 35	0B23H
		10 – 36	0A24H			11 – 36	0B24H
		10 – 37	0A25H			11 – 37	0B25H
		10 – 38	0A26H			11 – 38	0B26H
		10 – 39	0A27H			11 – 39	0B27H
		10 – 40	0A28H			11 – 40	0B28H
		10 – 41	0A29H			11 – 41	0B29H
		10 – 42	0A2AH			11 – 42	0B2AH
		10 – 43	0A2BH			11 – 43	0B2BH

Function	Register No	Function	Register No	Function	Register No
<b>Group 11</b>		<b>Group 12</b>		<b>Group 12</b>	
11 – 44	0B2CH	12 – 00	High WORD: 2510H Low WORD: 2511H	12 – 35	0C23H
11 – 45	0B2DH	12 – 01	0C01H	12 – 36	0C24H
11 – 46	0B2EH	12 – 02	0C02H	12 – 37	0C25H
11 – 47	0B2FH	12 – 03	0C03H	12 – 38	0C26H
11 – 48	0B30H	12 – 04	0C04H	12 – 39	0C27H
11 – 49	0B31H	12 – 05	0C05H	12 – 40	0C28H
11 – 50	0B32H	12 – 06	0C06H	12 – 41	0C29H
11 – 51	0B33H	12 – 07	0C07H	12 – 42	0C2AH
11 – 52	0B34H	12 – 08	0C08H	12 – 43	0C2BH
11 – 53	0B35H	12 – 09	0C09H	12 – 44	0C2CH
11 – 54	0B36H	12 – 10	0C0AH	12 – 45	0C2DH
11 – 55	0B37H	12 – 11	0C0BH	12 – 46	0C2EH
11 – 56	0B38H	12 – 12	0C0CH	12 – 47	0C2FH
11 – 57	0B39H	12 – 13	0C0DH	12 – 48	0C30H
11 – 58	0B3AH	12 – 14	0C0EH	12 – 49	0C31H
11 – 59	0B3BH	12 – 15	0C0FH	12 – 50	0C32H
11 – 60	0B3CH	12 – 16	0C10H	12 – 51	0C33H
11 – 61	0B3DH	12 – 17	0C11H	12 – 52	0C34H
11 – 62	0B3EH	12 – 18	0C12H	12 – 53	0C35H
11 – 63	0B3FH	12 – 19	0C13H	12 – 54	0C36H
11 – 64	0B40H	12 – 20	0C14H	12 – 55	0C37H
11 – 65	0B41H	12 – 21	0C15H	12 – 56	0C38H
11 – 66	0B42H	12 – 22	0C16H	12 – 57	0C39H
11 – 67	0B43H	12 – 23	0C17H	12 – 58	0C3AH
11 – 68	0B44H	12 – 24	0C18H	12 – 59	0C3BH
11 – 69	0B45H	12 – 25	0C19H	12 – 60	0C3CH
11 – 70	0B46H	12 – 26	0C1AH	12 – 61	0C3DH
11 – 71	0B47H	12 – 27	0C1BH	12 – 62	0C3EH
11 – 72	0B48H	12 – 28	0C1CH	12 – 63	0C3FH
11 – 73	0B49H	12 – 29	0C1DH	12 – 64	0C40H
11 – 74	0B4AH	12 – 30	0C1EH	12 – 65	0C41H
11 – 75	0B4BH	12 – 31	0C1FH	12 – 66	0C42H
11 – 76	0B4CH	12 – 32	0C20H	12 – 67	0C43H
11 – 77	0B4DH	12 – 33	0C21H	12 – 68	0C44H
11 – 78	0B4EH	12 – 34	0C22H	12 – 69	0C45H

Function	Register No	Function	Register No	Function	Register No	Function	Register No
<b>Group 12</b>		<b>Group 13</b>		<b>Group 13</b>		<b>Group 14</b>	
12 – 70	0C46H	13 – 00	0D00H	13 – 35	0D23H	14 – 00	0E00H
12 – 71	0C47H	13 – 01	0D01H	13 – 36	0D24H	14 – 01	0E01H
12 – 72	0C48H	13 – 02	0D02H	13 – 37	0D25H	14 – 02	0E02H
12 – 73	0C49H	13 – 03	0D03H	13 – 38	0D26H	14 – 03	0E03H
12 – 74	0C4AH	13 – 04	0D04H	13 – 39	0D27H	14 – 04	0E04H
12 – 75	0C4BH	13 – 05	0D05H	13 – 40	0D28H	14 – 05	0E05H
12 – 76	0C4CH	13 – 06	0D06H	13 – 41	0D29H	14 – 06	0E06H
12 – 77	0C4DH	13 – 07	0D07H	13 – 42	0D2AH	14 – 07	0E07H
12 – 78	0C4EH	13 – 08	0D08H	13 – 43	0D2BH	14 – 08	0E08H
12 – 79	0C4FH	13 – 09	0D09H	13 – 44	0D2CH	14 – 09	0E09H
12 – 80	0C50H	13 – 10	0D0AH	13 – 45	0D2DH	14 – 10	0E0AH
12 – 81	0C51H	13 – 11	0D0BH	13 – 46	0D2EH	14 – 11	0E0BH
12 – 82	0C52H	13 – 12	0D0CH	13 – 47	0D2FH	14 – 12	0E0CH
		13 – 13	0D0DH	13 – 48	0D30H	14 – 13	0E0DH
		13 – 14	0D0EH	13 – 49	0D31H	14 – 14	0E0EH
		13 – 15	0D0FH	13 – 50	0D32H	14 – 15	0E0FH
		13 – 16	0D10H	13 – 46	0D2EH	14 – 16	0E10H
		13 – 17	0D11H	13 – 47	0D2FH	14 – 17	0E11H
		13 – 18	0D12H	13 – 48	0D30H	14 – 18	0E12H
		13 – 19	0D13H	13 – 49	0D31H	14 – 19	0E13H
		13 – 20	0D14H	13 – 50	0D32H	14 – 20	0E14H
		13 – 21	0D15H			14 – 21	0E15H
		13 – 22	0D16H			14 – 22	0E16H
		13 – 23	0D17H			14 – 23	0E17H
		13 – 24	0D18H			14 – 24	0E18H
		13 – 25	0D19H			14 – 25	0E19H
		13 – 26	0D1AH			14 – 26	0E1AH
		13 – 27	0D1BH			14 – 27	0E1BH
		13 – 28	0D1CH			14 – 28	0E1CH
		13 – 29	0D1DH			14 – 29	0E1DH
		13 – 30	0D1EH			14 – 30	0E1EH
		13 – 31	0D1FH			14 – 31	0E1FH
		13 – 32	0D20H			14 – 32	0E20H
		13 – 33	0D21H			14 – 33	0E21H
		13 – 34	0D22H			14 – 34	0E22H

Function	Register No	Function	Register No	Function	Register No
<b>Group 14</b>		<b>Group 15</b>		<b>Group 16</b>	
14 – 35	0E23H	15 – 00	0F00H	16 – 00	1000H
14 – 36	0E24H	15 – 01	0F01H	16 – 01	1001H
14 – 37	0E25H	15 – 02	0F02H	16 – 02	1002H
14 – 38	0E26H	15 – 03	0F03H	16 – 03	1003H
14 – 39	0E27H	15 – 04	0F04H	16 – 04	1004H
14 – 40	0E28H	15 – 05	0F05H	16 – 05	1005H
14 – 41	0E29H	15 – 06	0F06H	16 – 06	1006H
14 – 42	0E2AH	15 – 07	0F07H	16 – 07	1007H
14 – 43	0E2BH	15 – 08	0F08H	16 – 08	1008H
14 – 44	0E2CH	15 – 09	0F09H	16 – 09	1009H
14 – 45	0E2DH	15 – 10	0F0AH		
14 – 46	0E2EH	15 – 11	0F0BH		
14 – 47	0E2FH	15 – 12	0F0CH		
		15 – 13	0F0DH		
		15 – 14	0F0EH		
		15 – 15	0F0FH		
		15 – 16	0F10H		
		15 – 17	0F11H		
		15 – 18	0F12H		
		15 – 19	0F13H		
		15 – 20	0F14H		
		15 – 21	0F15H		
		15 – 22	0F16H		
		15 – 23	0F17H		
		15 – 24	0F18H		
		15 – 25	0F19H		
		15 – 26	0F1AH		
		15 – 27	0F1BH		
		15 – 28	0F1CH		
		15 – 29	0F1DH		
		15 – 30	0F1EH		
		15 – 31	0F1FH		
		15 – 32	0F20H		

<b>Function</b>	<b>Register No</b>	<b>Function</b>	<b>Register No</b>	<b>Function</b>	<b>Register No</b>
<b>Group 17</b>		<b>Group 18</b>		<b>Group 19</b>	
17 – 00	1100H	18 – 00	1200H	19 – 00	1300H
17 – 01	1101H	18 – 01	1201H	19 – 01	1301H
17 – 02	1102H	18 – 02	1202H	19 – 02	1302H
17 – 03	1103H	18 – 03	1203H	19 – 03	1303H
17 – 04	1104H	18 – 04	1204H	19 – 04	1304H
17 – 05	1105H	18 – 05	1205H	19 – 05	1305H
17 – 06	1106H	18 – 06	1206H	19 – 06	1306H
17 – 07	1107H			19 – 07	1307H
17 – 08	1108H				
17 – 09	1109H				
17 – 10	110AH				
17 – 11	110BH				
17 – 12	110CH				
17 – 13	110DH				
17 – 14	110EH				



Function	Register No	Function	Register No	Function	Register No
<b>Group 20</b>		<b>Group 20</b>		<b>Group 21</b>	
20 – 00	1400H	20 – 37	1425H	21 – 00	1500H
20 – 01	1401H	20 – 38	1426H	21 – 01	1501H
20 – 02	1402H	20 – 39	1427H	21 – 02	1502H
20 – 03	1403H	20 – 40	1428H	21 – 03	1503H
20 – 04	1404H	20 – 41	1429H	21 – 04	1504H
20 – 05	1405H	20 – 42	142AH	21 – 05	1505H
20 – 06	1406H	20 – 43	142BH	21 – 06	1506H
20 – 07	1407H	20 – 44	142CH	21 – 07	1507H
20 – 08	1408H			21 – 08	1508H
20 – 09	1409H			21 – 09	1509H
20 – 10	140AH			21 – 10	150AH
20 – 11	140BH			21 – 11	150BH
20 – 12	140CH			21 – 12	150CH
20 – 13	140DH			21 – 13	150DH
20 – 14	140EH			21 – 14	150EH
20 – 15	140FH			21 – 15	150FH
20 – 16	1410H			21 – 16	1510H
20 – 17	1411H			21 – 17	1511H
20 – 18	1412H			21 – 18	1512H
20 – 19	1413H			21 – 19	1513H
20 – 20	1414H			21 – 20	1514H
20 – 21	1415H			21 – 21	1515H
20 – 22	1416H			21 – 22	1516H
20 – 23	1417H			21 – 23	1517H
20 – 24	1418H			21 – 24	1518H
20 – 25	1419H			21 – 25	1519H
20 – 26	141AH			21 – 26	151AH
20 – 27	141BH			21 – 27	151BH
20 – 28	141CH			21 – 28	151CH
20 – 29	141DH			21 – 29	151DH
20 – 30	141EH			21 – 30	151EH
20 – 31	141FH			21 – 31	151FH
20 – 32	1420H			21 – 32	1520H
20 – 33	1421H				
20 – 34	1422H				
20 – 35	1423H				
20 – 36	1424H				

Function	Register No	Function	Register No	Function	Register No
<b>Group 21</b>		<b>Group 22</b>			
21 – 33	1521H	22 – 00	1600H		
21 – 34	1522H	22 – 01	1601H		
21 – 35	1523H	22 – 02	1602H		
21 – 36	1524H	22 – 03	1603H		
21 – 37	1525H	22 – 04	1604H		
21 – 38	1526H	22 – 05	1605H		
21 – 39	1527H	22 – 06	1606H		
21 – 40	1528H	22 – 07	1607H		
21 – 41	1529H	22 – 08	1608H		
21 – 42	152AH	22 – 09	1609H		
21 – 43	152BH	22 – 10	160AH		
		22 – 11	160BH		
		22 – 12	160CH		
		22 – 13	160DH		
		22 – 14	160EH		
		22 – 15	160FH		
		22 – 16	1610H		
		22 – 17	1611H		
		22 – 18	1612H		
		22 – 19	1613H		
		22 – 20	1614H		
		22 – 21	1615H		
		22 – 22	1616H		
		22 – 23	1617H		
		22 – 24	1618H		
		22 – 25	1619H		
		22 – 26	161AH		
		22 – 27	161BH		
		22 – 28	161CH		
		22 – 29	161DH		
		22 – 30	161EH		
		22 – 31	161FH		

# Chapter 5 Check Motor Rotation and Direction

This test is to be performed solely from the inverter keypad. Apply power to the inverter after all the electrical connections have been made and protective covers have been re-attached.

**Important: Motor rotation and direction only applies to standard AC motors with a base frequency of 60Hz. For 50Hz or other frequency AC motors please set the max frequency and base frequency in group 01 accordingly before running the motors.**

## ◆ LED Keypad Display

At this point, **DO NOT RUN THE MOTOR**, the LED keypad should display as shown below in Fig. 5.1 and all LEDs are flashing. Next press the **RUN** key, all LEDs light on. See Fig 5.2. The motor should now be operating at low speed running in forward (clockwise) direction. The value shown in the screen will change from 000.00Hz to 005.00Hz. Next press **STOP** key to stop the motor.



Fig 5.1: LED Keypad (Stopped)



Fig 5.2: LED Keypad (Running)

## ◆ LCD Keypad Display

At this point, **DO NOT RUN THE MOTOR**, the LCD keypad should display as shown below in Fig. 5.3 and the speed reference 12-16=005.00Hz should be blinking at the parameter code “12-16”. Next press the **RUN** key, see Fig 5.4. The motor should now be operating at low speed running in forward (clockwise) direction. The parameter code 12-17 shown at the bottom left corner of the screen will change from 12-17=000.00Hz to 12-17=005.00Hz. Next press **STOP** key to stop the motor.



Fig 5.3: LCD Keypad (Stopped)



Fig 5.4: LCD Keypad (Running)

### Notes:

- If the motor rotation is incorrect, power down the inverter.
- After the power has been turned OFF, wait at least ten minutes until the charge indicator extinguishes completely before touching any wiring, circuit boards or components.
- Using Safety precaution, and referring to section 3.8 exchange any two of the three output leads to the motor (U/T1, V/T2 and W/T3). After the wiring change, repeat this step and recheck motor direction.

# Chapter 6 Speed Reference Command Configuration

The inverter offers users several choices to set the speed reference source. The most commonly used methods are described in the next sections.

Frequency reference command is selected with parameter 00-05.

## 00-05: Main Frequency Command (Frequency Source)

This function sets the frequency command source.

**Setting Range:** 0 to 5

To set parameter 00-05:

- After power-up press the **DSP/FUN** key
- Set Group **00** (Basic Fun), and select parameter -05 with the **UP/DOWN ▲** and **▼** keys and press the **READ/ ENTER** key.

00-05	Main Frequency Command Source Selection
Range	<b>0:</b> Keypad <b>1:</b> External control (analog) <b>2:</b> Terminal command UP / DOWN <b>3:</b> Communication control (RS-485) <b>4:</b> Pulse input <b>5:</b> Reserved <b>6:</b> Reserved <b>7:</b> AI2 Auxiliary Frequency <b>8:</b> Manual Pulse Generator (MPG)

## 6.1 Reference from Keypad

### ◆ LED Keypad:

Use the </RESET, ▲ and ▼ keys to change the speed reference and then press the **READ/ ENTER** key. Refer to section 4.1.5 for more details.

### ◆ LCD Keypad:

Press the **READ/ ENTER** key first and use the </RESET, ▲ and ▼ keys to change the speed reference.

## 6.2 Reference from External Analog Signal (0-10V / 4-20mA)

Analog Reference: 0 – 10 V (Setting 00-05 = 1)

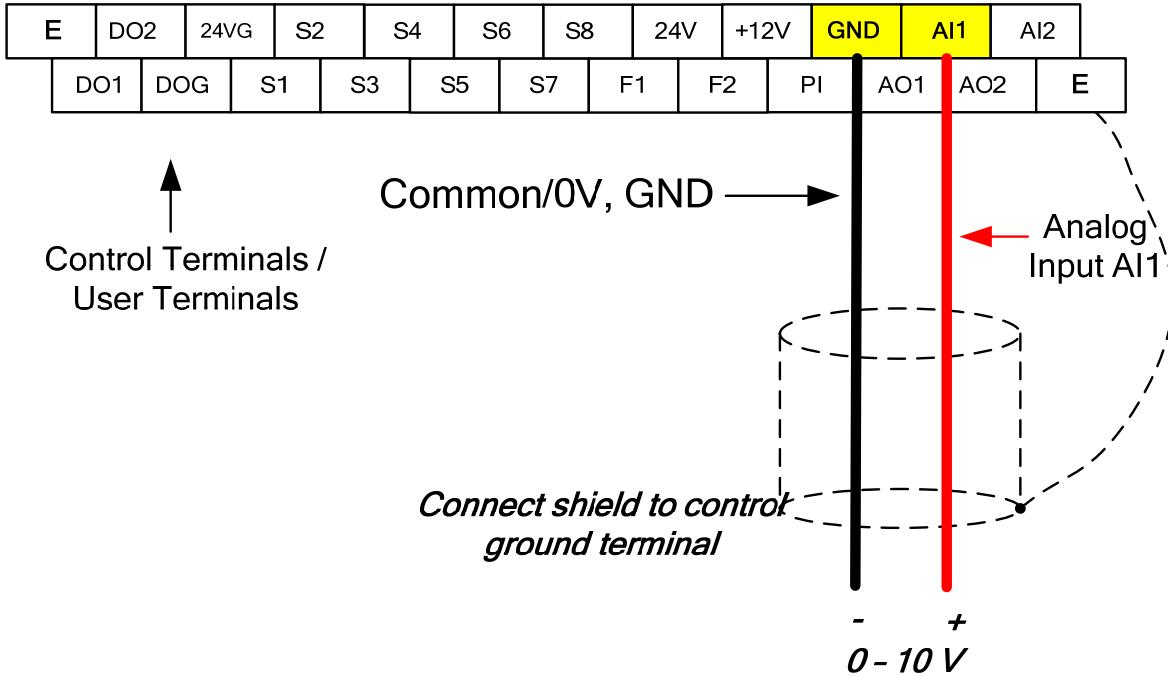

Analog Reference: Potentiometer / Speed Pot (Setting 00-05 = 1)

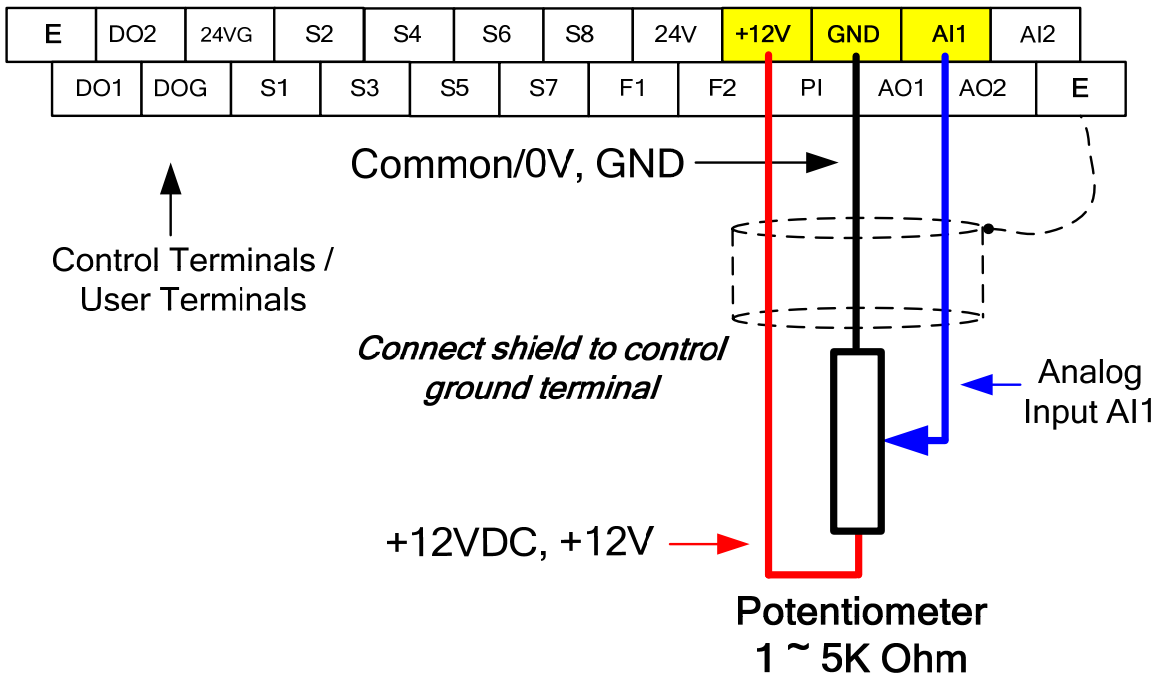

**Analog Reference: 4 – 20mA (Setting 00-05 = 1)**

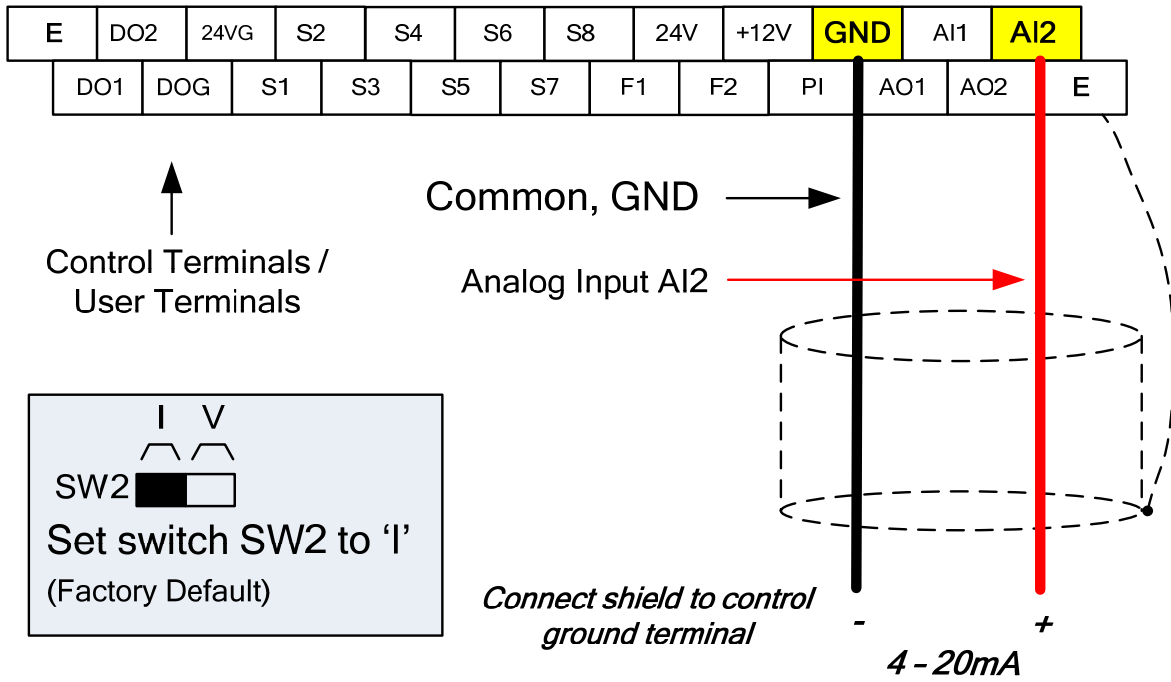

## 6.3 Reference from Serial Communication RS485 (00-05=3)

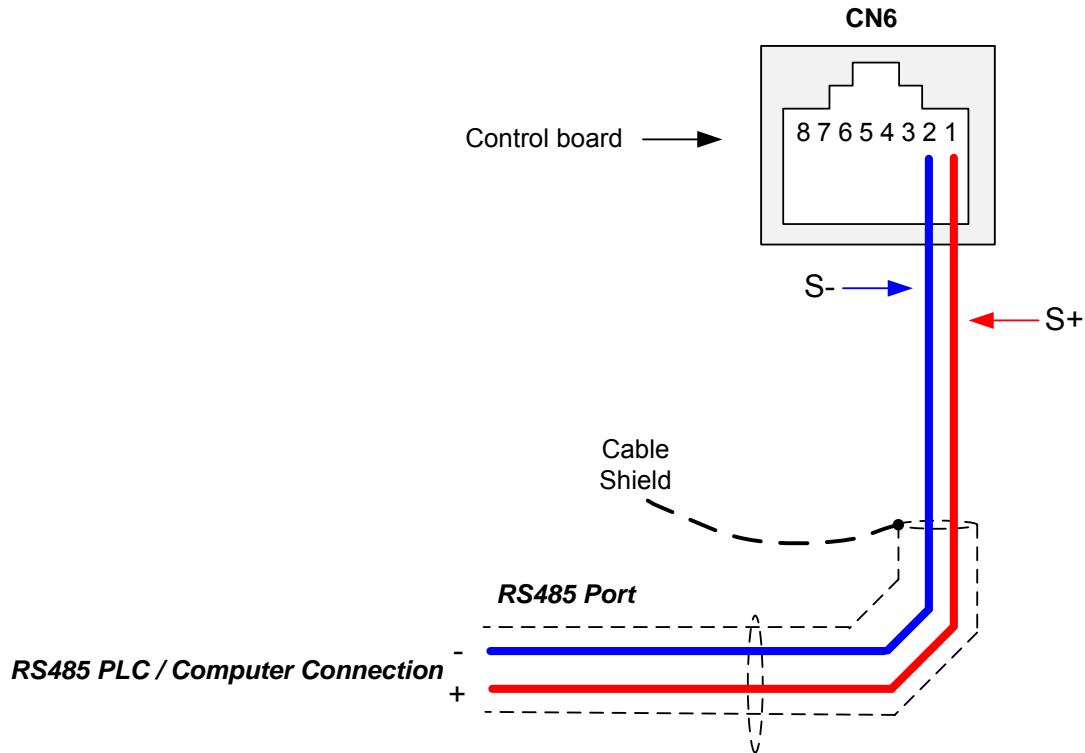

To set the speed reference for the inverter via serial communication parameter 00-05 has be set to “3” for frequency command via serial communication.

**Default Communication Setting is:** Address “1”, 9600 Bits/sec, 1 Start Bit, 1 Stop Bit, and No Parity

The serial communication link function uses RS485 Modbus RTU protocol and allows for:

- 1) Monitoring (data monitoring, function data check).
- 2) Frequency setting.
- 3) Operation command (FWD, REV, and other commands for digital input).
- 4) Write function data.

### Frequency Reference Command Register

Inverter Frequency Reference Register: 2502 (Hexadecimal) - Bit 0 – Bit 15: 0.00 ~ 599.00 Hz



**Examples:**

**Frequency Reference Command: 10.00 Hz (Inverter Node Address: 01)**

Command String (hexadecimal): 01 06 25 02 03 E8 23 B8

To set the frequency reference to 10.00, a value of '1000' (03E8h) has to be send to the inverter.

**Frequency Reference Command: 30.00 Hz (Inverter Node Address: 01)**

Command String (hexadecimal): 01 06 25 02 0B B8 24 44

To set the frequency reference to 30.00, a value of '3000' (0BB8h) has to be send to the inverter.

**Frequency Reference Command: 60.00 Hz (Inverter Node Address: 01)**

Command String (hexadecimal): 01 06 25 02 17 70 2D 12

To set the frequency reference to 60.00, a value of '6000' (1770h) has to be send to the inverter

**Note:** The last 2 bytes of the command strings consist of a CRC16 checksum, please refer to section 4.5 of the instruction manual for additional information.

## 6.4 Reference from Pulse Input (00-05=4)

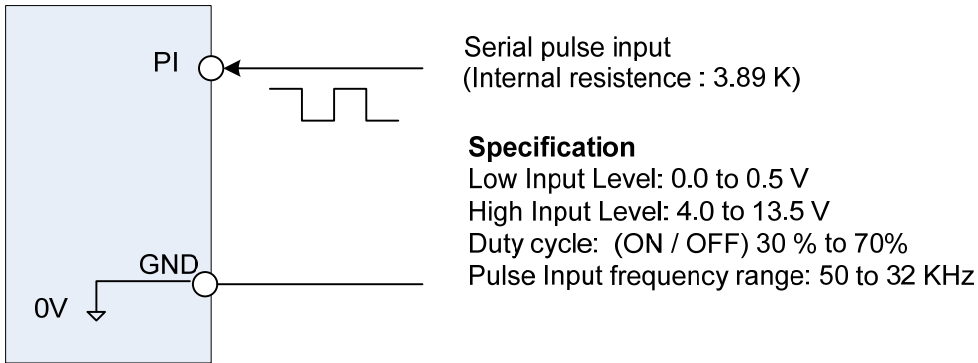

### Set Pulse Input Setup as Frequency Reference

Set parameter 00-05 to 4 and 03-30 to 0 to use the pulse input terminal PI as the frequency reference source. Next set the pulse input scaling (03-31), enter the pulse input frequency to match the maximum output frequency. Adjust the pulse input filter time in case interference or noise is encountered.

**Example:** Pulse train input maximum 10 kHz, set parameter 03-31 to 10000 when maximum frequency is set to 60.0Hz.

03- 30	Selection of Pulse Input
<b>Range</b>	0: General Pulse Input 1: PWM

Function selects source for the pulse input.

03-31	Scale of pulse input
<b>Range</b>	Depending on the setting of 03-30 03-30 = 0: 50~32000Hz 03-30 = 1:10~1000Hz

Pulse input scaling, 100% = Maximum pulse frequency.

03- 32	Pulse input gain
<b>Range</b>	0.0~1000.0 %

Target value (03-03) in % = Pulse input frequency scaled to 100% based on maximum pulse frequency (03-31) times the gain (03-32) + bias (03-33).

03-33	Pulse input bias
<b>Range</b>	-100.0~100.0 %

Target value (03-03) in % = Pulse input frequency scaled to 100% based on maximum pulse frequency (03-31) times the gain (03-32) + bias (03-33).

03-34	Pulse input filter time
<b>Range</b>	0.00~2.00 Sec

## 6.5 Reference from two Analog Inputs

Analog input AI1 is used as master frequency reference and analog input AI2 is used as auxiliary frequency reference.

**Analog Reference AI1: 0 – 10 V (Setting 00-05 = 1)**

**Analog Reference AI2: 0 – 10 V (Setting 00-06 = 1, 04-05 = 1)**

AI1 – Analog Input 1	AI2 – Analog Input 2	04-00 Setting (Default = 1)	Dipswitch SW2 (Default 'V')
0 ~ 10V	0 ~ 10V	0	Set to 'V'
0 ~ 10V	4 ~ 20mA	1	Set to 'I'

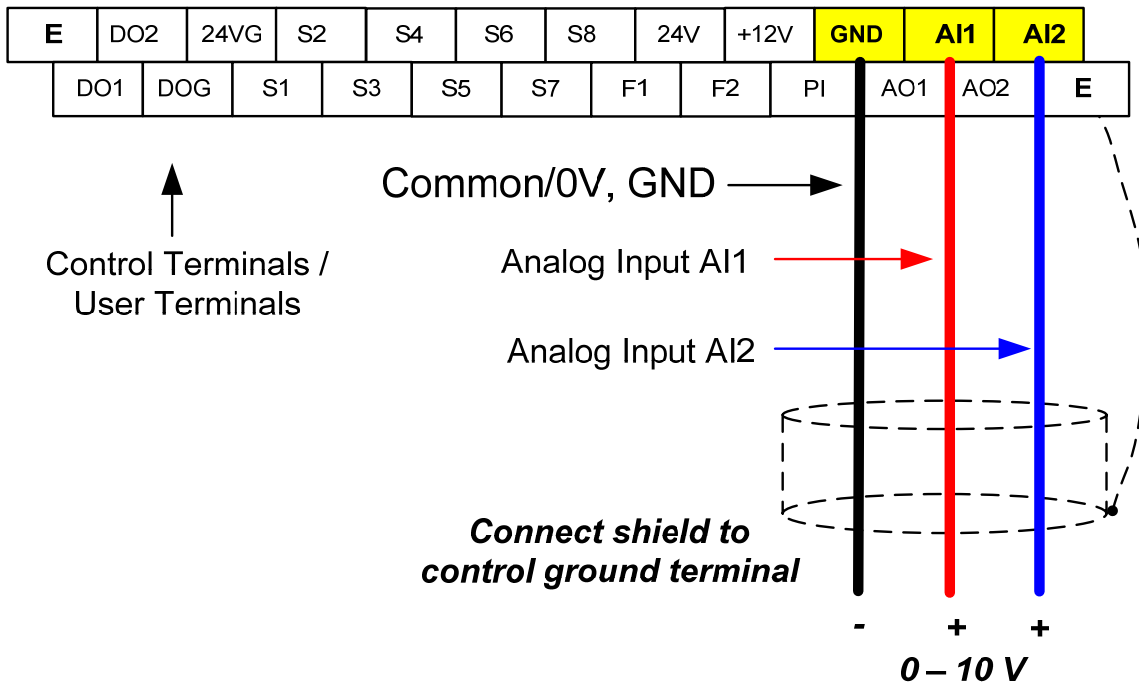

## 6.6 Change Frequency Unit from Hz to rpm

Enter the number of motor poles in 16-03 to change the display units from Hz to rpm.

16-03	Display unit
Range	0: Frequency display unit is Hz (Resolution is 0.01Hz)
	1: Frequency display unit is % (Resolution is 0.01%)
	2: Frequency display unit is rpm.
	3~39: Reserved
	40~9999: 100% is XXXX with no decimals (integer only)
	10001~19999: 100% is XXX.X with 1 decimal
	20001~29999: 100% is XX.XX with 2 decimals
30001~39999: 100% is X.XXX with 3 decimals	

## Chapter 7 Operation Method Configuration (Run / Stop)

The inverter offers users several choices to run and stop from different sources. The most commonly used methods are described in the next sections.

Operation command is selected with parameter 00-02.

### 00-02: Run Command Selection

This function sets the frequency command source.

**Setting Range:** 0 to 3

To set parameter 00-02:

- After power-up press the **DSP/FUN** key
- Set Group **00** (Basic Fun), and select parameter -02 with the **UP/DOWN ▲** and **▼** keys and press the **READ/ ENTER** key.

<b>00-02</b>	<b>Main Run Command Source Selection</b>
<b>Range</b>	<b>0:</b> Keypad control <b>1:</b> External terminal control <b>2:</b> Communication control (RS-485) <b>3:</b> PLC

### 7.1 Run/Stop from the LED/LCD Keypad (00-02=0)

Use the **RUN** key to run the drive in forward direction and the **FWD/REV** key to change the motor direction. (Note: to disable reverse direction set parameter 11-01 to 1)

Press **STOP** key to stop the inverter. (Note: Stop method can be set with parameter 07-09, default is **deceleration to stop**).



## 7.2 Run/Stop from External Switch / Contact or Pushbutton (00-02=1)

Use an external contact or switch to Run and Stop the inverter.

**Example: NPN wiring**

### ◆ Permanent Switch / Contact

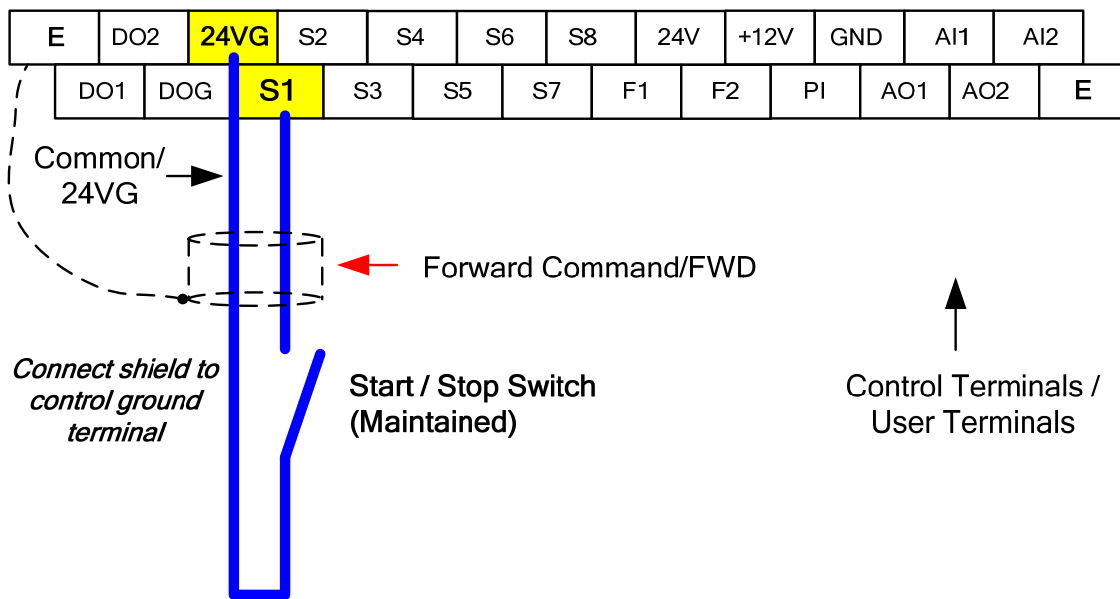

◆ **Momentary Contacts (Push Buttons)**

Use push button / momentary switch to Run and Stop the inverter.

Set parameter 13-08 to 3, 5 or 7 for 3-wire program initialization, multi-function input terminal S1 is set to run operation, S2 for stop operation and S7 for forward/reverse command.

**00-01 Operation Method = 1**

**03-07 Terminal S7 Function = 26**

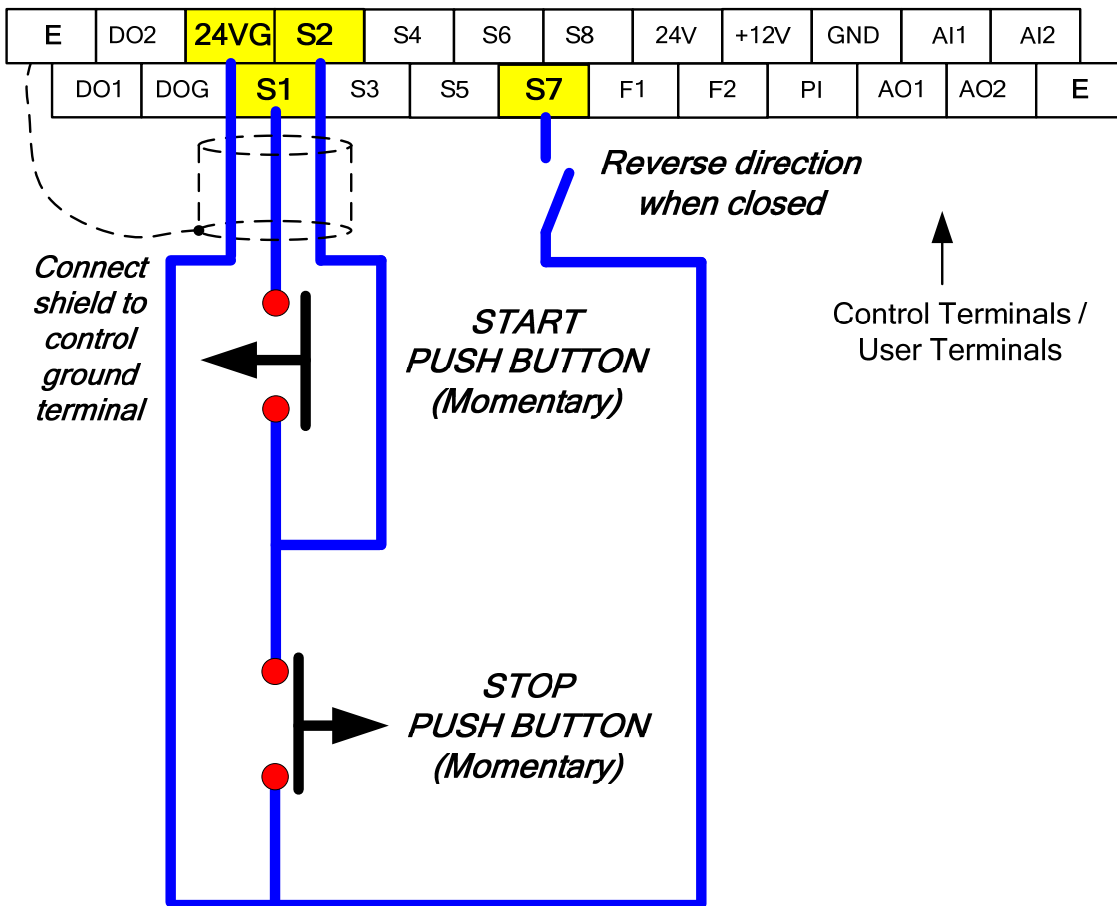

**Note:** Stop mode selection can be set with parameter 07-09, default is **deceleration to stop**.

## 7.3 Run/Stop from Serial Communication RS485 (00-02=3)

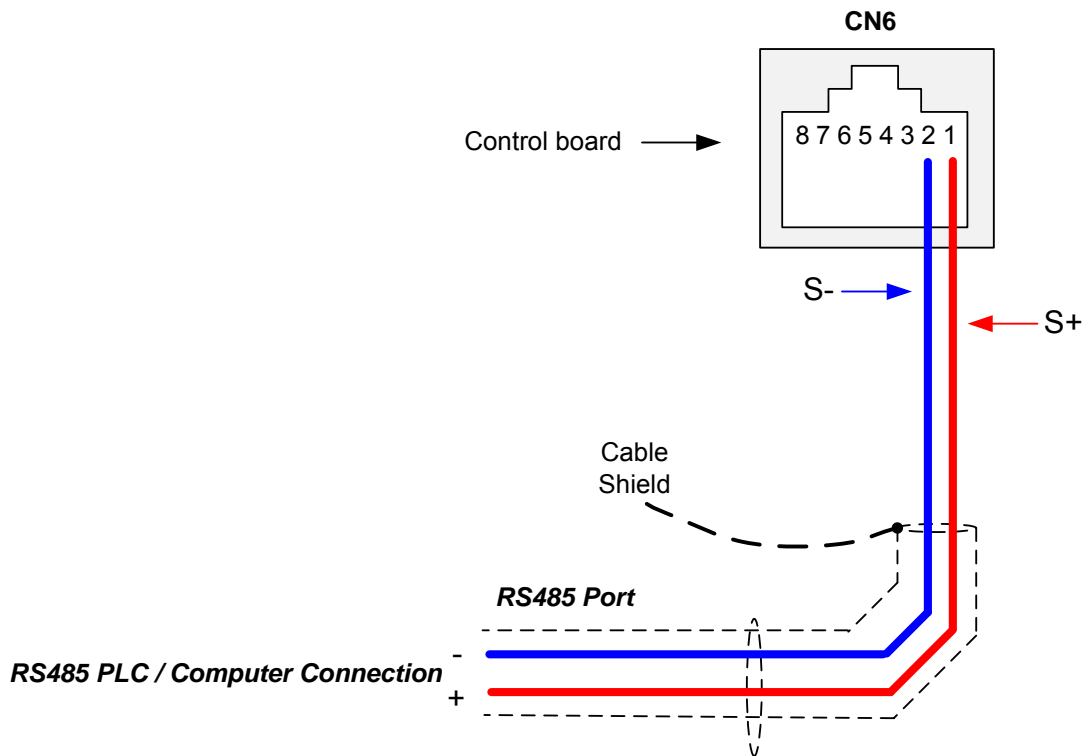

To control (Run/Stop) the inverter via serial communication parameter 00-02 has be set to either a “2” for communication control.

**Default Communication Setting is:** Address “1”, 19200 Bits/sec, 1 Start Bit, 1 Stop Bit, and No Parity

The serial communication link function uses RS485 Modbus RTU protocol and allows for:

- 1) Monitoring (data monitoring, function data check).
- 2) Frequency setting.
- 3) Operation command (FWD, REV, and other commands for digital input).
- 4) Write function data.

### Command Register

Inverter Command Register: 2501 (Hexadecimal)

Bit 0: Run Forward

Bit 1: Run Reverse

Bit 2 ~ Bit 15: Refer to the chapter XX of this manual

**Examples:**

**Run Forward Command (Inverter Node Address: 01)**

Command String (hexadecimal): 01 06 25 01 00 01 12 C6

**Run Reverse Command (Inverter Node Address: 01)**

Command String (hexadecimal): 01 06 25 01 00 03 93 07

**Stop Command (Inverter Node Address: 01)**

Command String (hexadecimal): 01 06 25 01 00 00 D3 06

**Note:** The last 2 bytes of the command strings consist of a CRC16 checksum, please refer to section 4.5 of the instruction manual for additional information.



## Chapter 8 Motor and Application Specific Settings

It is essential that before running the motor, the motor nameplate data matches the motor data in the inverter.

### 8.1 Set Motor Nameplate Data (02-01, 02-05)

#### 02-05 Rated power of motor 1

The nominal motor rated capacity is set at the factory. Please verify that the motor name plate data matches the motor rated capacity shown in parameter 02-05. The setting should only be changed when driving a motor with a different capacity.

**Range:** 0.00 to 600.00 kW (1HP = 0.746 kW)

To set parameter 02-05:

- After power-up press the **DSP/FUN** key
- Set Group **02** (Motor Parameter), and select parameter -05 with the **UP/DOWN ▲** and **▼** keys and press the **READ/ ENTER** key.

Default values vary based on the inverter model.

---

#### 02-01 Rated current of motor 1

The motor rated current is set at the factory based on the inverter model. Enter the motor rated current from the motor nameplate if it does not match the value shown in parameter 02-01.

**Setting range:** 0.01 to 600.00A

To set parameter 02-01:

- After power-up press the **DSP/FUN** key
  - Set Group **02** (Motor Parameter), and select parameter -01 with the **UP/DOWN ▲** and **▼** keys and press the **READ/ ENTER** key.
-

## 8.2 Acceleration and Deceleration Time (00-14, 00-15)

Acceleration and Deceleration times directly control the system dynamic response. In general, the longer the acceleration and deceleration time, the slower the system response, and the shorter time, the faster the response. An excessive amount of time can result in sluggish system performance while too short of a time may result in system instability.

The default values suggested normally result in good system performance for the majority of general purpose applications. If the values need to be adjusted, caution should be exercised, and the changes should be in small increments to avoid system instability.

### 00-14 Acceleration time 1

### 00-15 Deceleration time 1

These parameters set the acceleration and deceleration times of the output frequency from 0 to maximum frequency and from maximum frequency to 0.

To set parameter 00-14 or 00-15:

- After power-up press the **DSP/FUN** key
- Set Group **00** (Basic Fun), and select parameter -14 or -15 with the **UP/DOWN ▲** and **▼** keys and press the **READ/ ENTER** key.

Acceleration and deceleration times are represented by the three most significant (high order) digits. Set acceleration and deceleration times with respect to maximum frequency. The relationship between the set frequency value and acceleration/deceleration times is as follows:

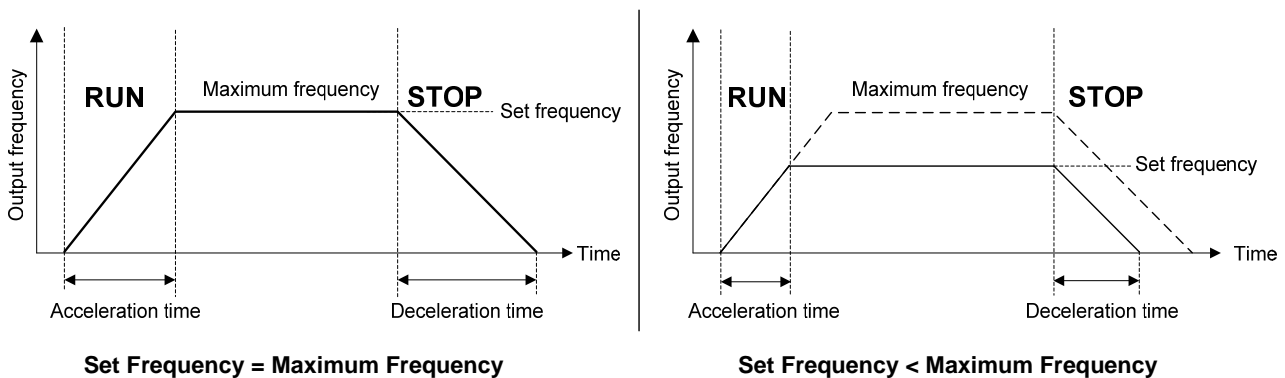

**Note:** If the set acceleration and deceleration times are set too low, the torque limiting function or stall prevention function can become activated if the load torque and or inertia are relatively high. This will prolong the acceleration and or deceleration times and not allow the set times to be followed. In this case the acceleration and or the deceleration times should be adjusted.

## 8.3 Torque Compensation Gain (01-10)

This parameter sets the relationship between output frequency and output voltage. Constant torque applications have the same torque requirements at low speed as well as at high speed.

### Initial Setup

For Variable Torque / Normal Duty applications set parameter 01-10 to an initial value of 0.5.

For Constant Torque / Heavy Duty applications set parameter 01-10 to an initial value of 1.0.

01-10 Torque compensation gain

This parameter sets the torque boost for motor 1.

**Setting range:** 0.0 to 2.0

To set parameter 01-10:

- After power-up press the **DSP/FUN** key
- Set Group **01** (V/F Pattern), and select parameter -10 with the **UP/DOWN ▲** and **▼** keys and press the **READ/ ENTER** key.

Increase value when:

- The wiring between the inverter and the motor very too long
- The motor size is smaller than the inverter size

**Note:** Gradually increase the torque compensation value and make sure the output current does not exceed inverter rated current.

Reduce value when:

- Experiencing motor vibration
- Over Current Fault
- Overload Fault

**Important:** Confirm that the output current at low speed does not exceed the rated output current of the inverter.



**Warning: A larger than required torque compensation gain value creates over-excitation at low speeds, continued operation may cause the motor to overheat. Check the characteristics of the motor for additional information.**

## 8.4 Automatic Energy Saving Functions (11-19)

In the V/F control mode the automatic energy saving (AES) function automatically adjusts the output voltage and reduces the output current of the inverter to optimize energy savings based on the load.

The output power changes proportional to the motor load. Energy savings is minimal when the load exceeds 70% of the output power and savings become greater when the load decreases.

The parameter of automatic energy saving function has been set at the factory before shipment. In general, it is no need to adjust. If the motor characteristic has significant difference from TECO standard, please refer to the following commands for adjusting parameters:

### Enable Automatic Energy Savings Function

To set parameters 11-19 to 11-24:

- After power-up press the **DSP/FUN** key
- Set Group **11** (Auxiliary Function Group), and select parameter -19 to -24 with the **UP/DOWN ▲** and **▼** keys and press the **READ/ ENTER** key.

- (1) To enable automatic energy saving function set 11-19 to 1.
- (2) Filter time of automatic energy saving (11-20)
- (3) Commissioning parameter of energy saving (11-21 to 11-22)

In AES mode, the optimum voltage value is calculated based on the load power requirement but is also affected by motor temperature and motor characteristic.

In certain applications the optimum AES voltage needs to be adjusted in order to achieve optimum energy savings. Use the following AES parameters for manual adjustment:

#### 11-21: Voltage limit value of AES commissioning operation

Sets the voltage upper limit during automatic energy saving. 100% corresponds to 220V or 440V depending on the inverter class used.

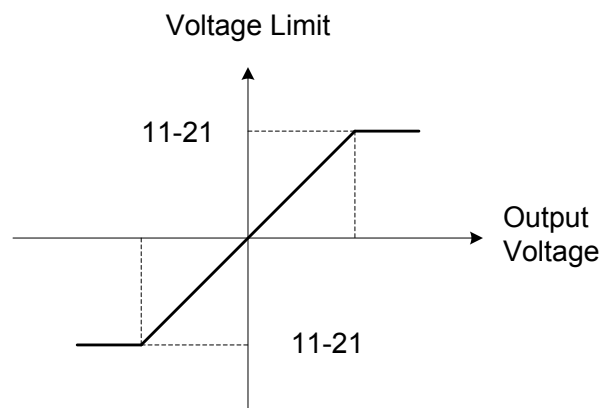

**Voltage limit value of commissioning operation**

**11-22:** Adjustment time of automatic energy saving

Set sample time constant for measuring output power.

Reduce the value of 11-22 to increase response when the load changes.

**Note:** If the value of 11-22 is too low and the load is reduced the motor may become unstable.

**11-23:** Detection level of automatic energy saving

Set the automatic energy saving output power detection level.

**11-24:** Coefficient of automatic energy saving

The coefficient is used to tune the automatic energy saving. Adjust the coefficient while running the inverter on light load while monitoring the output power. A lower setting means lower output voltage.

**Notes:**

- If the coefficient is set to low the motor may stall.
- Coefficient default value is based on the inverter rating. Set parameter 13-00. If the motor power does not match the inverter rating.

## 8.5 Emergency Stop

The emergency stop time is used in combination with multi-function digital input function #14 (Emergency stop). When emergency stop input is activated the inverter will decelerate to a stop using the Emergency stop time (00-26) and display the [EM STOP] condition on the keypad.

**Note:** To cancel the emergency stop condition the run command has to be removed and emergency stop input deactivated.

**Example: Emergency Stop Switch with NPN wiring set for input terminal S5 (03-04 = 14).**

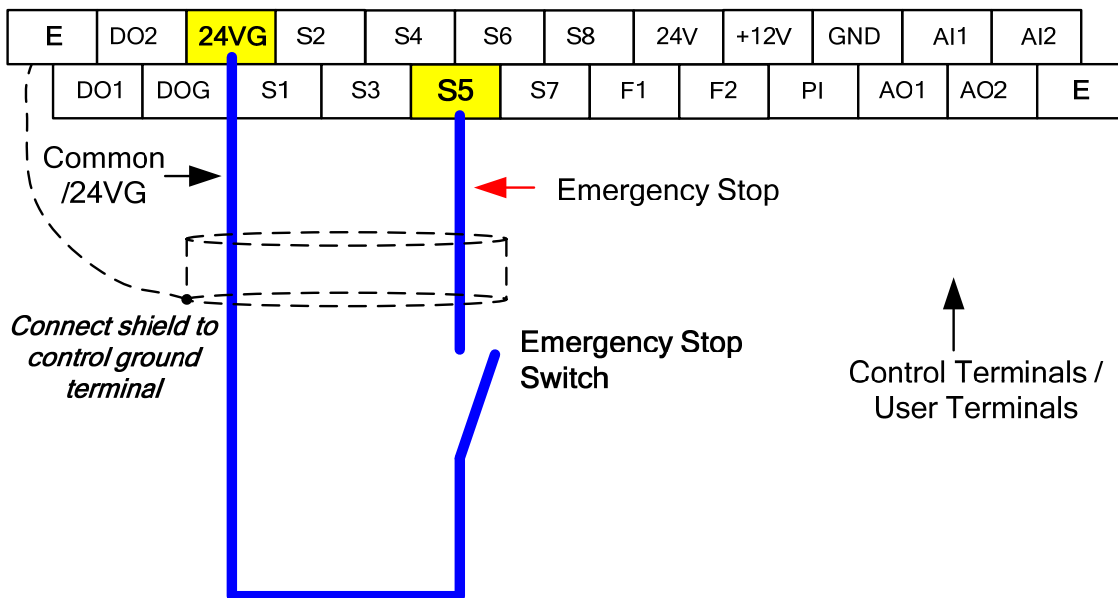

<b>00-26</b>	<b>Emergency stop time</b>
<b>Range</b>	0.1~6000.0 Sec

## 8.6 Forward and Reverse Jog

The jog forward command is used in combination with multi-function digital input function #6 (Jog Forward) and the jog reverse command is used in combination with multi-function digital input function #7 (Jog Reverse).

**Example: Jog Forward input terminal S5 (03-04 = 06) and Jog Reverse input terminal S7 (03-06=7) with NPN wiring.**

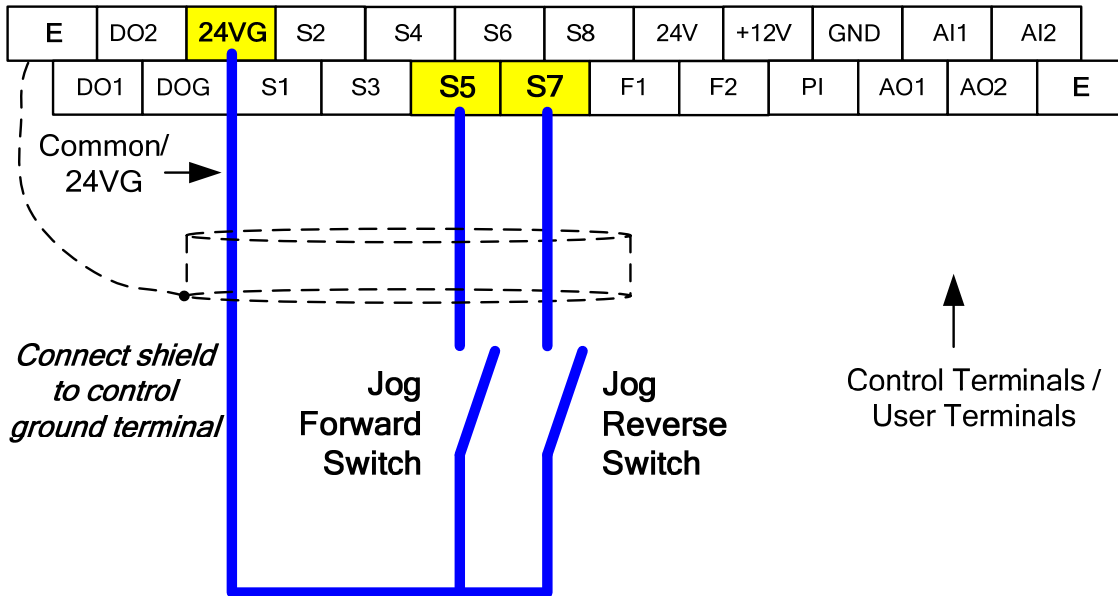

## 8.7 Direct / Unattended Startup

The unattended startup function prevents the inverter from starting automatically when a run command is present at time of power-up. To use USP command set one of the multi-function digital input functions to #50 (USP Startup).

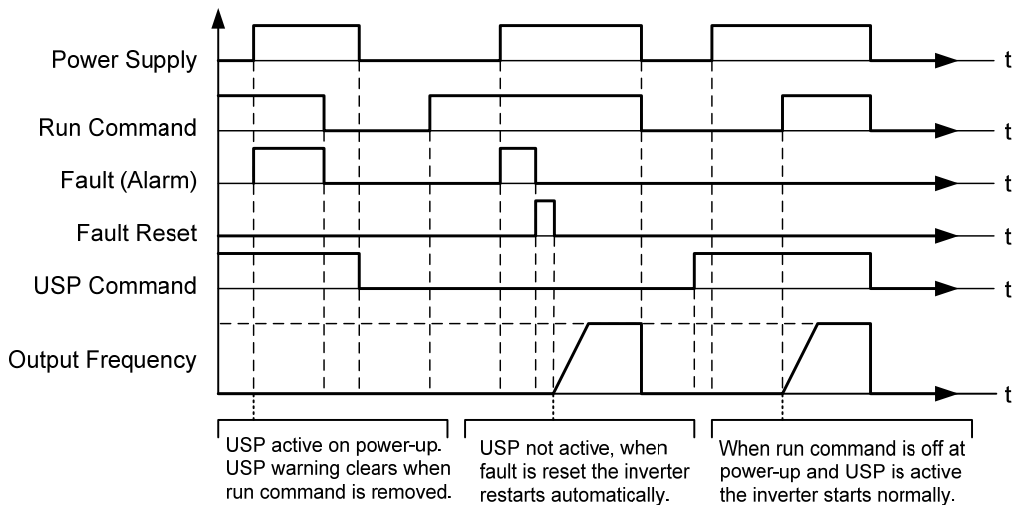

**Unattended Startup Protection**

## 8.8 Analog Output Setup

**Signal:** Use parameter 04-11 to select the analog output signal for AO1 and parameter 04-16 to select the analog output signal for AO2.

**Gain:** Use parameter 04-12 to adjust the gain for AO1 and parameter 04-17 to adjust the gain for AO2. Adjust the gain so that the analog output (10V) matches 100% of the selected analog output signal (04-11 for AO1 and 04-16 for AO2).

**Bias:** Use parameter 04-13 to adjust the bias for AO1 and parameter 04-18 to adjust the bias for AO2. Adjust the bias so that the analog output (0V) matches 0% of the selected analog output signal (04-11 for AO1 and 04-16 for AO2).

### Example: Analog Output 1 Wiring

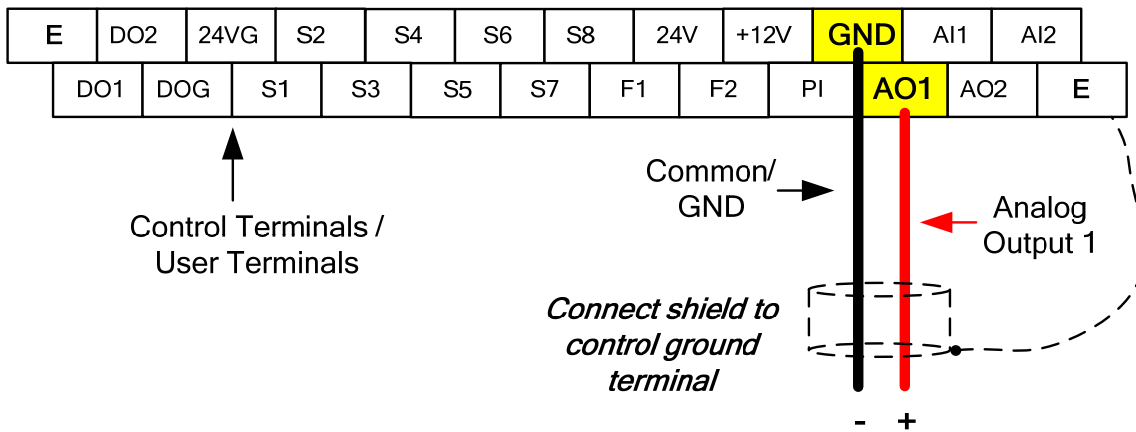

04-11	AO1 function Setting			
Range	0:	Output frequency	15:	ASR output
	1:	Frequency command	16:	Reserved
	2:	Output voltage	17:	q-axis voltage
	3:	DC voltage	18:	d-axis voltage
	4:	Output current	19:	Reserved
	5:	Output power	20:	Reserved
	6:	Motor speed	21:	PID input
	7:	Output power factor	22:	PID output
	8:	AI1 input	23:	PID target value
	9:	AI2 input	24:	PID feedback value
	10:	Torque command	25:	Output frequency of the soft starter
	11:	q -axis current	26:	PG feedback
	12:	d-axis current	27:	Reserved
	13:	Speed deviation	28:	Communication control
14:	Reserved			



<b>04-12</b>	<b>AO1 gain</b>
<b>Range</b>	0.0~1000.0%
<b>04-13</b>	<b>AO1 bias</b>
<b>Range</b>	-100.0~100.0%
<b>04-16</b>	<b>AO2 function Setting</b>
<b>Range</b>	See parameter 04-11
<b>04-17</b>	<b>AO2 gain</b>
<b>Range</b>	0.0~1000.0%
<b>04-18</b>	<b>AO2 bias</b>
<b>Range</b>	-100.0~100.0%
<b>04-19</b>	<b>AO2 Output Signal Type</b>
<b>Range</b>	0: AO2 0~10V 1: AO2 4~20mA
<b>04-20</b>	<b>Filter Time of AO Signal Scan</b>
<b>Range</b>	0.00~0.50s

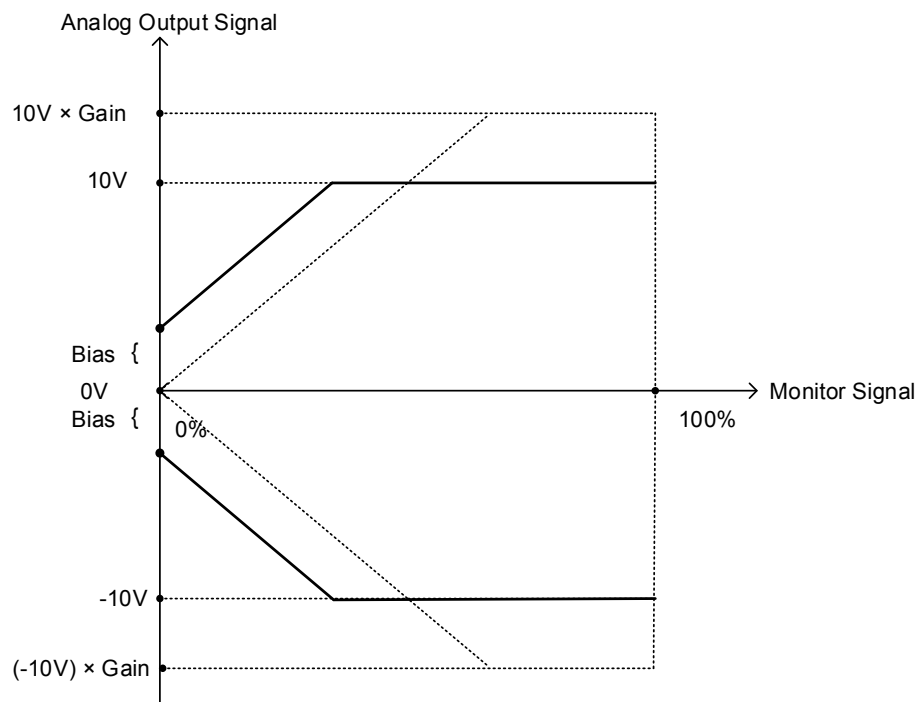

**Analog output level adjustment**

# Chapter 9 Using PID Control for Constant Flow / Pressure Applications

## 9.1 What is PID Control?

The PID function in the inverter can be used to maintain a constant process variable such as pressure, flow, temperature by regulating the output frequency (motor speed). A feedback device (transducer) signal is used to compare the actual process variable to a specified setpoint. The difference between the set-point and feedback signal is called the error signal.

The PID control tries to minimize this error to maintain a constant process variable by regulating the the output frequency (motor speed).

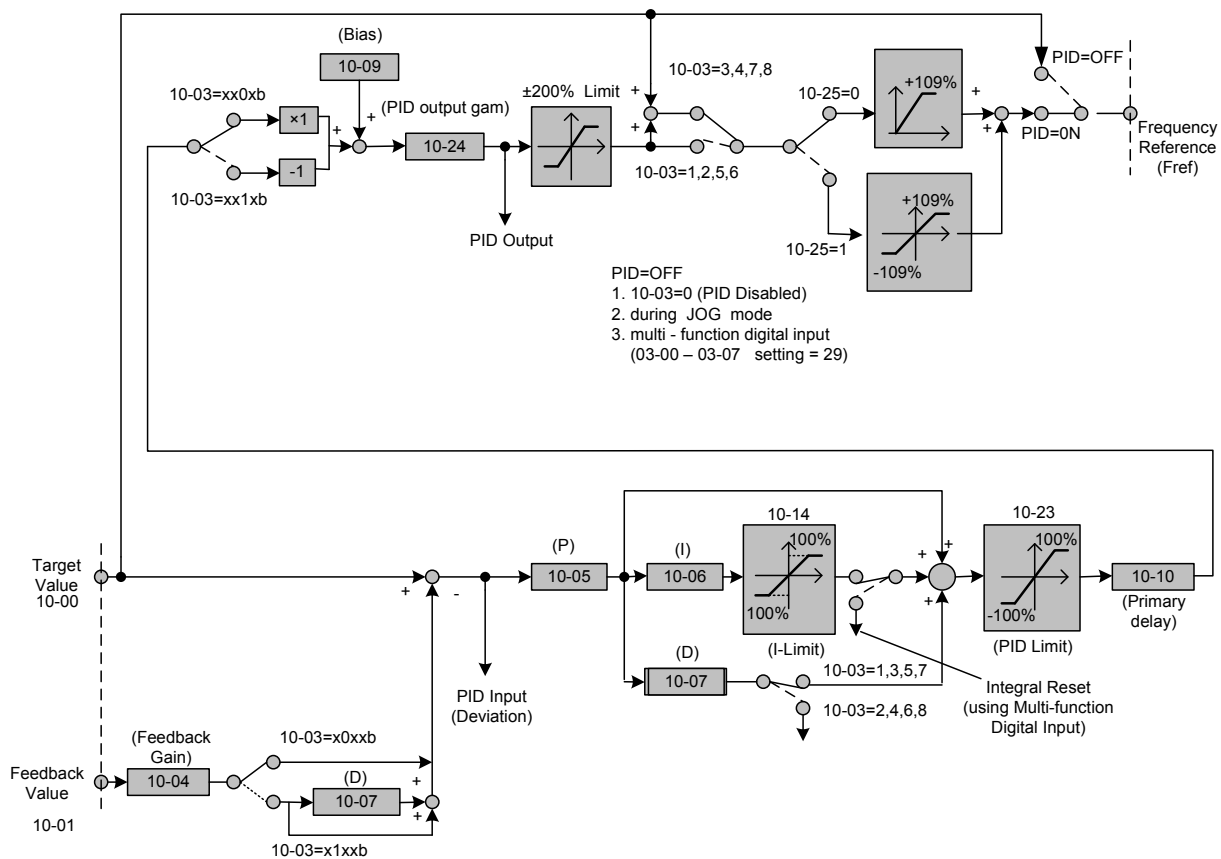

The amplitude of the error can be adjusted with the Proportional Gain parameter 10-05 and is directly related to the output of the PID controller, so the larger the gain the larger the output correction.

**Example 1:**

Gain = 1.0

Set-Point = 80%

Feedback = 78%

Error = Set-point - Feedback = 2%

Control Error = Gain x Error = 2%

**Example 2:**

Gain = 2.0

Set-Point = 80%

Feedback = 78%

Error = Set-point - Feedback = 2%

Control Error = Gain x Error = 4%

Please note that an excessive gain can make the system unstable and oscillation may occur.

The response time of the system can be adjusted with the Integral Gain set by parameter 10-06. Increasing the Integral Time will make the system less responsive and decreasing the Integral Gain Time will increase response but may result in instability of the total system.

Slowing the system down too much may be unsatisfactory for the process. The end result is that these two parameters in conjunction with the acceleration (00-14) and deceleration (00-15) times are adjusted to achieve optimum performance for a particular application.

**For typical fan and pump applications a Proportional Gain (10-05) of 2.0 and an Integral Time (10-06) of 5.0 sec is recommended.**

**10-03 PID control mode**

PID control can be enabled by setting parameter 10-03 to 'xxx1b'

10-03	PID control mode
<b>Range</b>	<b>xxx0b:</b> PID disable <b>xxx1b:</b> PID enable <b>xx0xb:</b> PID positive characteristic <b>xx1xb:</b> PID negative characteristic <b>x0xxb:</b> PID error value of D control <b>x1xxb:</b> PID feedback value of D control <b>0xxxb:</b> PID output <b>1xxxb:</b> PID output + frequency command

## Commonly used PID control modes

**0001b:** Forward operation: PID operation enabled, motor speeds increases when feedback signal is smaller than set-point (most fan and pump applications)

**0011b:** Reverse operation: PID operation enabled, motor slows down when feedback signal is smaller than set-point (e.g. level control applications)

To set parameter 10-03:

- After power-up press the **DSP/FUN** key
- Set Group **10** (PID Control), and select parameter -03 with the **UP/DOWN ▲** and **▼** keys and press the **READ/ ENTER** key.

**Important:** To use the PID function parameter 00-05 (Main Frequency Command Source Selection) has to be set to 5 for PID reference.

## 9.2 Connect Transducer Feedback Signal (10-01)

The PID function in the inverter

Depending on the type of feedback transducer used, the inverter can be setup for either 0-10V or a 4-20mA feedback transducer.

**Feedback Signal from AI2 (10-01 = 2), and set the input current to 4 – 20mA / SW2 = I**

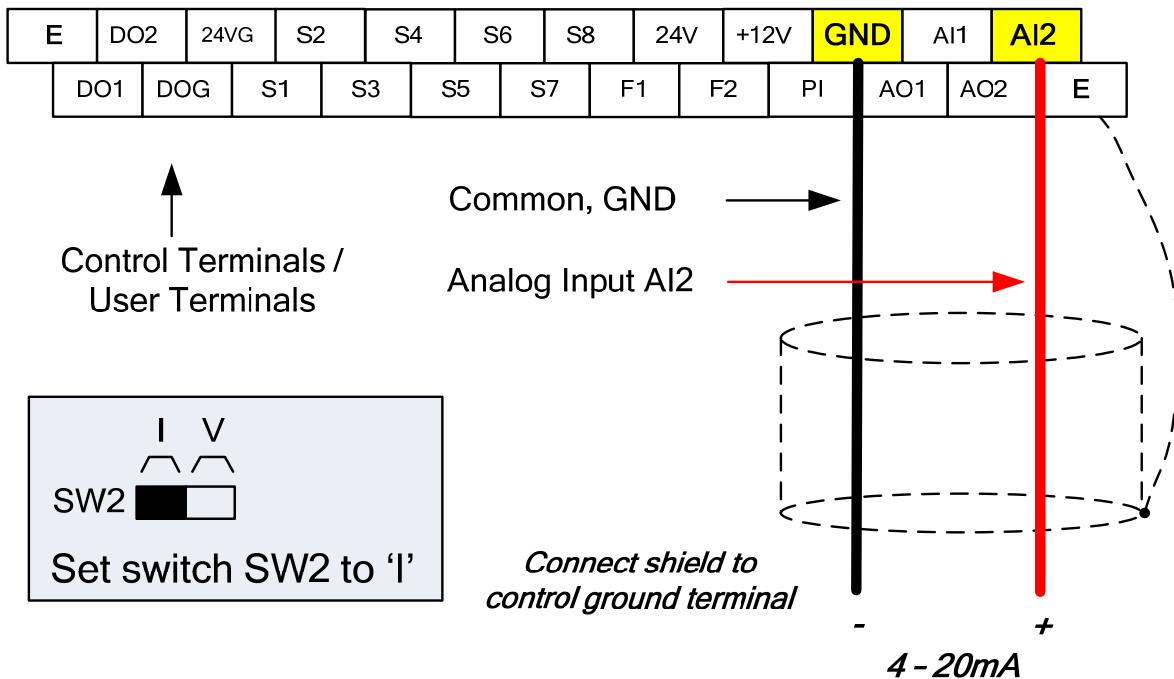

**Feedback Signal from AI1 (10-01 = 1), and set the input voltage to 0 – 10V / SW2 = V**

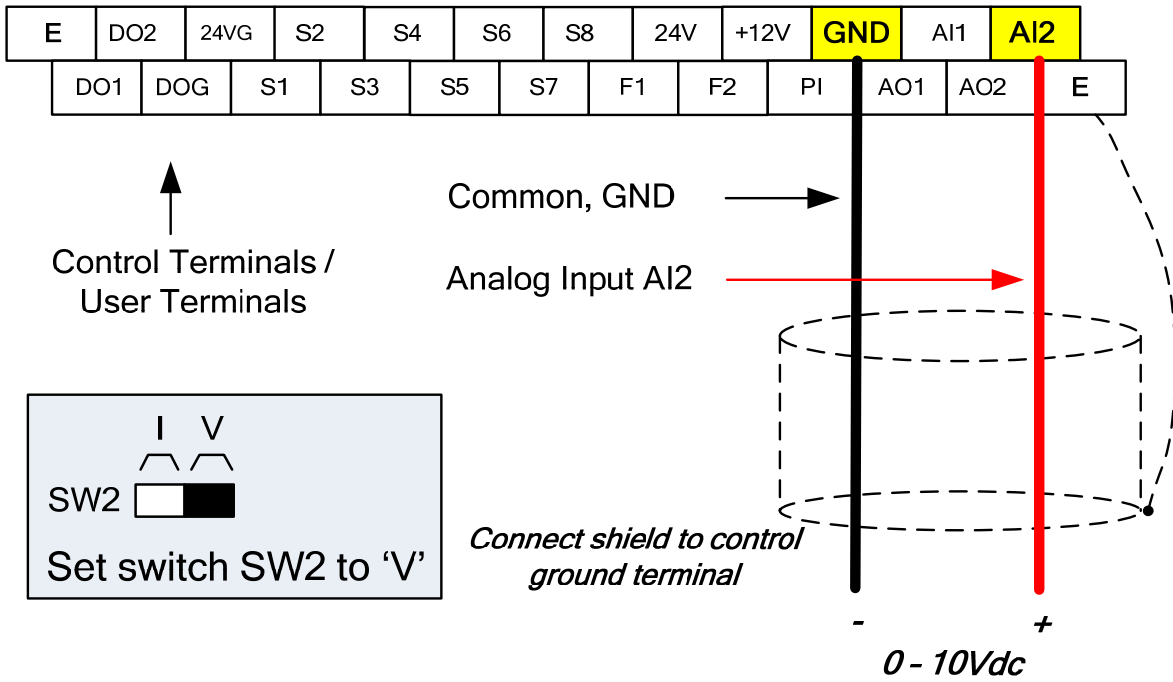

### 9.3 Engineering Units (only for LCD)

The PID setpoint scaling can be selected with parameter 16-03 and 16-04.

**Example:** 0 – 200.0 PSI Setpoint, set 16-03 to 12000 (1 decimal, range 0 – 200) and 16-04 to 2 (PSI).

## 9.4 Sleep / Wakeup Function

The PID Sleep function can be used to prevent a system from running at low speeds and is frequently used in pumping application. The PID Sleep function is turned on by parameter 10-29 set to 1. The inverter output turns off when the PID output falls below the PID sleep level (10-17) for the time specified in the PID sleep delay time parameter (10-18).

The inverter wakes up from a sleep condition when the PID output (Reference frequency) rises above the PID wake-up frequency (10-19) for the time specified in the PID wake-up delay time (10-20).

**10-29 =0:** PID Sleep function is disabled.

**10-29 =1:** PID sleep operation is based on parameters of 10-17 and 10-18.

**10-29 =2:** PID sleep mode is enabled by multi-function digital input

Refer to the following figures for PID sleep / wakeup operation.

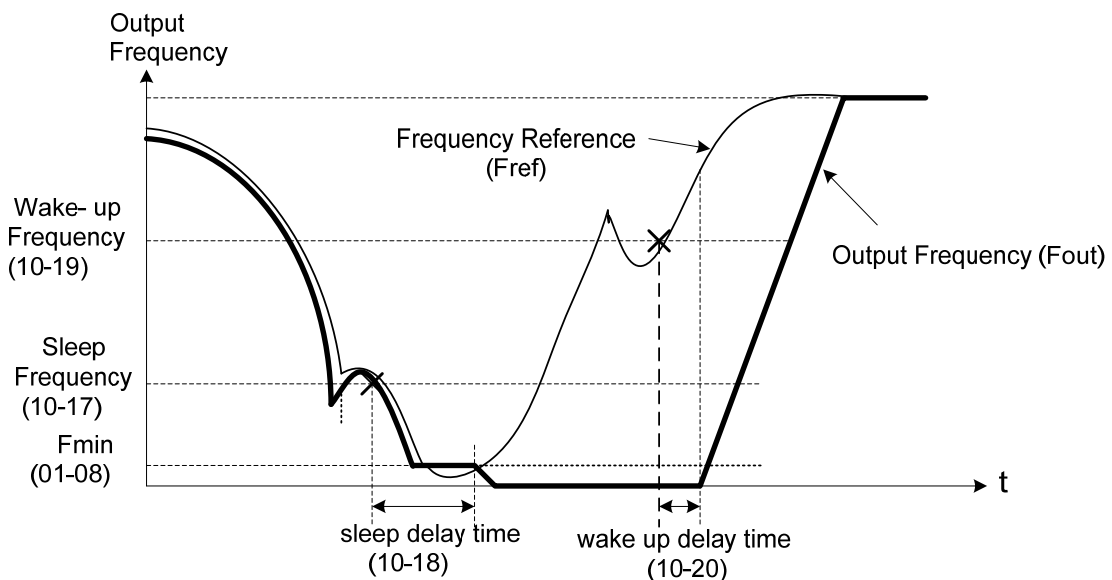
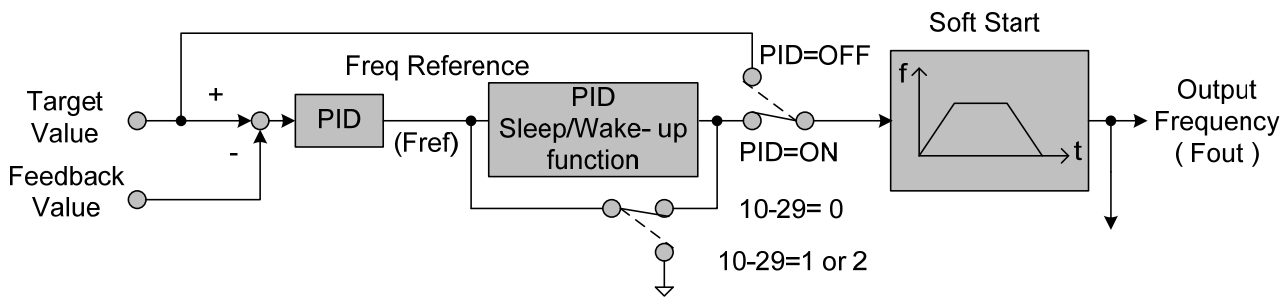

**PID Sleep Function**

# Chapter 10 Troubleshooting and Fault Diagnostics

## 10.1 General

Inverter fault detection and early warning / self-diagnosis function. When the inverter detects a fault, a fault message is displayed on the keypad. The fault contact output energizes and the motor will coast to stop (The stop method can be selected for specific faults).

When the inverter detects a warning / self-diagnostics error, the digital operator will display a warning or self-diagnostic code, the fault output does not energize in this case. Once the warning is removed, the system will automatically return to its original state.

## 10.2 Fault Detection Function



When a fault occurs, please refer to Table 10.2.1 for possible causes and take appropriate measures.







Use one of the following methods to restart:

1. Set one of multi-function digital input terminals (03-00, 03-07) to 17 (Fault reset); activate input
2. Press the reset button on the keypad.
3. Power down inverter wait until keypad goes blank and power-up the inverter again.

When a fault occurs, the fault message is stored in the fault history (see group 12 & 13).

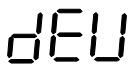

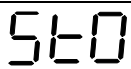

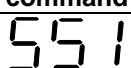

**Table 10.2.1 Fault information and possible solutions**



LED display	Description	Cause	Possible solutions
<p><b>OC</b> over current</p> 	<p>The inverter output current exceeds the overcurrent level (200% of the inverter rated current).</p>	<ul style="list-style-type: none"> <li>• Acceleration / Deceleration time is too short.</li> <li>• Contactor at the inverter output side.</li> <li>• A special motor or applicable capacity is greater than the inverter rated value.</li> <li>• Short circuit or ground fault.</li> </ul>	<ul style="list-style-type: none"> <li>• Extend acceleration / deceleration time.</li> <li>• Check the motor wiring.</li> <li>• Disconnect motor and try running inverter.</li> </ul>
<p><b>OCA</b> over current</p> 			
<p>The inverter output current exceeds the overcurrent level in acceleration time</p>	<ul style="list-style-type: none"> <li>• Acceleration time is too short</li> <li>• Capacity of motor is bigger than inverter</li> <li>• Short circuit between winding and shell of motor</li> <li>• Short circuit between wire and ground of motor</li> <li>• IGBT broken module</li> </ul>	<ul style="list-style-type: none"> <li>• Set the longer acceleration time</li> <li>• Change to bigger capacity of inverter</li> <li>• Examine motor</li> <li>• Check the wire</li> <li>• Replace IGBT module</li> </ul>	
<p><b>OCC</b> over current</p> 	<p>The inverter output current exceeds the overcurrent level in constant speed</p>	<ul style="list-style-type: none"> <li>• Instantaneous change of load</li> <li>• Instantaneous change of current</li> </ul>	<ul style="list-style-type: none"> <li>• Change to bigger capacity of inverter</li> <li>• Add reactor to power source</li> </ul>

LED display	Description	Cause	Possible solutions
OCd over current 	The inverter output current exceeds the overcurrent level in deceleration time	<ul style="list-style-type: none"> <li>• Deceleration time is too short</li> </ul>	<ul style="list-style-type: none"> <li>• Set the longer acceleration time</li> </ul>
SC short circuit 	Inverter output short circuit or ground fault.	<ul style="list-style-type: none"> <li>• Short circuit or ground fault (08-23 = 1).</li> <li>• Motor damaged (insulation).</li> <li>• Wire damage or deterioration.</li> </ul>	<ul style="list-style-type: none"> <li>• Check the motor wiring.</li> <li>• Disconnect motor and try running inverter.</li> </ul>
GF Ground fault 	The current to ground exceeds 50% of the inverter rated output current (08-23 = 1, GF function is enabled).	<ul style="list-style-type: none"> <li>• Motor damaged (insulation).</li> <li>• Wire damage or deterioration.</li> <li>• Inverter DCCT sensors defect.</li> </ul>	<ul style="list-style-type: none"> <li>• Replace motor.</li> <li>• Check the motor wiring.</li> <li>• Disconnect motor and try running inverter.</li> <li>• Check resistance between cables and ground.</li> <li>• Reduce carrier frequency.</li> </ul>
OV Over voltage 	DC bus voltage exceeds the OV detection level: 200V class: 410Vdc 400V class: 820Vdc 575V class: 1050Vdc 690V class: 1230Vdc	<ul style="list-style-type: none"> <li>• Deceleration time set too short, resulting in regenerative energy flowing back from motor to the inverter.</li> <li>• The inverter input voltage is too high.</li> <li>• Use of power factor correction capacitors.</li> <li>• Excessive braking load.</li> <li>• Braking transistor or resistor defective.</li> <li>• Speed search parameters set incorrectly.</li> </ul>	<ul style="list-style-type: none"> <li>• Increase deceleration time</li> <li>• Reduce input voltage to comply with the input voltage requirements or install an AC line reactor to lower the input voltage.</li> <li>• Remove the power factor correction capacitor.</li> <li>• Use dynamic braking unit.</li> <li>• Replace braking transistor or resistor.</li> <li>• Adjust speed search parameters.</li> </ul>
UV Under voltage 	DC bus voltage is lower than the UV detection level or the pre-charge contactor is not active while the inverter is running. 200V class: 190Vdc 400V class: 380Vdc 575/690V class: 546Vdc (The detection value can be adjusted by 07-13).	<ul style="list-style-type: none"> <li>• The input voltage is too low.</li> <li>• Input phase loss.</li> <li>• Acceleration time set too short.</li> <li>• Input voltage fluctuation.</li> <li>• Pre-charge contactor damaged.</li> <li>• DC bus voltage feedback signal value not incorrect.</li> </ul>	<ul style="list-style-type: none"> <li>• Check the input voltage.</li> <li>• Check input wiring.</li> <li>• Increase acceleration time.</li> <li>• Check power source</li> <li>• Replace pre-charge contactor</li> <li>• Replace control board or complete inverter.</li> </ul>
IPL input phase loss 	Phase loss at the input side of the inverter or input voltage imbalance, active when 08-09 = 1 (enabled).	<ul style="list-style-type: none"> <li>• Wiring loose in inverter input terminal.</li> <li>• Momentary power loss.</li> <li>• Input voltage imbalance.</li> </ul>	<ul style="list-style-type: none"> <li>• Check input wiring / faster screws.</li> <li>• Check power supply.</li> </ul>

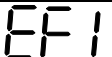

LED display	Description	Cause	Possible solutions
<b>OPL output phase loss</b>	Phase loss at the output side of the inverter, active when 08-10 = 1 (enabled).	<ul style="list-style-type: none"> <li>Wiring loose in inverter output terminal.</li> <li>Motor rated current is less than 10% of the inverter rated current.</li> </ul>	<ul style="list-style-type: none"> <li>Check output wiring / faster screws.</li> <li>Check motor &amp; inverter rating.</li> </ul>
<b>OPL</b>			
<b>OH1 Heatsink overheat</b>	The temperature of the heat sink is too high. Note: when OH1 fault occurs three times within five minutes, it is required to wait 10 minutes before resetting the fault.	<ul style="list-style-type: none"> <li>Ambient temperature too high.</li> <li>cooling fan failed</li> <li>Carrier frequency set too high.</li> <li>Load too heavy.</li> </ul>	<ul style="list-style-type: none"> <li>Install fan or AC to cool surroundings.</li> <li>Replace cooling fan.</li> <li>Reduce carrier frequency.</li> <li>Reduce load / Measure output current</li> </ul>
<b>OH1</b>			
<b>OL1 Motor overload</b>	Internal motor overload protection tripped, active when protection curve 08-05 = xxx1.	<ul style="list-style-type: none"> <li>Voltage setting V/F mode too high, resulting in over-excitation of the motor.</li> <li>Motor rated current (02-01) set incorrectly.</li> <li>Load too heavy.</li> </ul>	<ul style="list-style-type: none"> <li>Check V/f curve.</li> <li>Check motor rated current</li> <li>Check and reduce motor load, check and operation duty cycle.</li> </ul>
<b>OL1</b>			
<b>OL2 Inverter overload</b>	Inverter thermal overload protection tripped. If an inverter overload occurs 4 times in five minutes, it is required to wait 4 minutes before resetting the fault.	<ul style="list-style-type: none"> <li>Voltage setting V/F mode too high, resulting in over-excitation of the motor.</li> <li>Inverter rating too small.</li> <li>Load too heavy.</li> </ul>	<ul style="list-style-type: none"> <li>Check V/f curve.</li> <li>Replace inverter with larger rating.</li> <li>Check and reduce motor load, check and operation duty cycle.</li> </ul>
<b>OL2</b>			
<b>OT Over torque detection</b>	Inverter output torque is higher than 08-15 (over torque detection level) for the time specified in 08-16. Parameter 08-14 = 0 to activate.	<ul style="list-style-type: none"> <li>Load too heavy.</li> </ul>	<ul style="list-style-type: none"> <li>Check over torque detection parameters (08-15 / 08-16).</li> <li>Check and reduce motor load, check and operation duty cycle.</li> </ul>
<b>OT</b>			
<b>UT Under torque detection</b>	Inverter output torque is lower than 08-19 (under torque detection level) for the time specified in 08-20. Parameter 08-18 = 0 to activate.	<ul style="list-style-type: none"> <li>Sudden drop in load.</li> <li>Belt break.</li> </ul>	<ul style="list-style-type: none"> <li>Check under torque detection parameters (08-19 / 08-20).</li> <li>Check load / application.</li> </ul>
<b>UT</b>			
<b>run Switch for Motor1/Motor 2</b>	Switch for Motor1/Motor2 in running time	<ul style="list-style-type: none"> <li>Execute command for switching motor2 in running time</li> <li>Execute command for switching motor in running time</li> </ul>	<ul style="list-style-type: none"> <li>Revise the sequence control and switch motor in top time.</li> </ul>
<b>run</b>			
<b>OS Over speed</b>	Motor speed exceeds level set in 20-20 (PG Over speed Level) for the time set in 20-21 (PG over speed time). Active when 20-19 (= 0 or 1). This fault is active V/F + PG and SV control mode (00-00 = 1 or 3 or 4). Motor speed can be monitored by 12-22	<ul style="list-style-type: none"> <li>Motor speed overshoot (ASR)</li> <li>PG ppr set incorrectly.</li> <li>Overspeed parameters set incorrectly.</li> </ul>	<ul style="list-style-type: none"> <li>Check ASR parameters group 21.</li> <li>Check PG parameters</li> <li>Check overspeed parameters 20-20/20-12.</li> </ul>
<b>OS</b>			

LED display	Description	Cause	Possible solutions
<b>PGO</b> <b>PG</b> <b>Open circuit</b> 	PG pulses are not received by the inverter for the time specified in 20-26 (PG open circuit detection time). This fault is active V/F + PG and SV control mode (00-00 = 1 or 3 or 4).	<ul style="list-style-type: none"> <li>PG cable disconnected.</li> <li>PG has no power.</li> <li>Mechanical brake active preventing motor from turning.</li> </ul>	<ul style="list-style-type: none"> <li>Check PG wiring.</li> <li>Check PG power-supply.</li> <li>Make sure brake is released.</li> </ul>
<b>DEV</b> <b>Speed deviation</b> 	Motor speed rises above 20-23 level (PG speed deviation level) for the time specified in 20-24 (PG deviation time)...Active when parameter 20-22(=0 or 1). This fault is active V/F + PG and SV control mode (00-00 = 1 or 3 or 4).	<ul style="list-style-type: none"> <li>Load too heavy</li> <li>Mechanical brake active preventing motor from turning.</li> <li>PG wiring error.</li> <li>PG parameters (group 20) set incorrectly.</li> <li>Acceleration / deceleration time set to short.</li> </ul>	<ul style="list-style-type: none"> <li>Check load</li> <li>Make sure brake is released.</li> <li>Check PG wiring.</li> <li>Check PG parameters 20-23/20-24.</li> <li>Increase Acceleration / deceleration time.</li> </ul>
<b>CE</b> <b>communication error</b> 	No Modbus communication received in for the time specified in 09-06 (communication error detection time). Active when 09-07(= 0 to 2).	<ul style="list-style-type: none"> <li>Connection lost or wire broken.</li> <li>Host stopped communicating.</li> </ul>	<ul style="list-style-type: none"> <li>Check connection</li> <li>Check host computer / software.</li> </ul>
<b>FB</b> <b>PID feedback loss</b> 	PID feedback signal falls below level specified in 10-12 (PID feedback loss detection level) for the time specified in 10-13 (Feedback loss detection time). Active when parameter (10-11 = 2).	<ul style="list-style-type: none"> <li>Feedback signal wire broken</li> <li>Feedback sensor broken.</li> </ul>	<ul style="list-style-type: none"> <li>Check feedback wiring</li> <li>Replace feedback sensor.</li> </ul>
<b>STO</b> <b>Safety switch</b>  <b>STO2</b> <b>Safety switch</b> 	Run permissive input open.	<ul style="list-style-type: none"> <li>Terminal board Input F1 and F2 are not connected (For standard H &amp; C type)</li> <li>Terminal board Input SF1 / SF2 and SG are not connected (For enhanced E &amp; G type)</li> <li>08-30 set to 1, free run to stop, and digital terminal is open, when 03-00~03-07=58</li> </ul>	<ul style="list-style-type: none"> <li>Check F1 and F2 connection. (For standard H &amp; C type)</li> <li>Check SF1 / SF2 and SG connection (For enhanced E &amp; G type)</li> <li>Check if 08-30 =0 and 03-00~03-07=58</li> </ul>
<b>SS1</b> <b>Digital input Stop command</b> 	Digital input Stop command enabled	<ul style="list-style-type: none"> <li>08-30 =0 and 03-00~03-07=58</li> </ul>	<ul style="list-style-type: none"> <li>Check if 08-30 =0 and 03-00~03-07=58</li> </ul>
<b>EFO</b> <b>External fault 0</b> 	External fault (Modbus)	Modbus communication 0x2501 bit 2= "1"	<ul style="list-style-type: none"> <li>Reset Modbus communication 0x2501 bit 2= "1"</li> </ul>

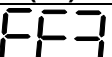
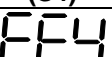
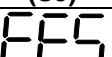
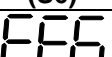
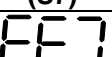
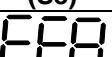
LED display	Description	Possible causes	Corrective action
EF1 External fault (S1) 	External fault (Terminal S1) Active when 03-00= 25 or 68, and Inverter external fault selection 08-24=0 or 1.	<ul style="list-style-type: none"> <li>• Multifunction digital input external fault active.</li> </ul>	<ul style="list-style-type: none"> <li>• Multi-function input function set incorrectly.</li> <li>• Check wiring</li> </ul>
EF2 External fault (S2) 	External fault (Terminal S2) Active when 03-01= 25 or 68, and Inverter external fault selection 08-24=0 or 1.		
EF3 External fault (S3) 	External fault (Terminal S3) Active when 03-02= 25 or 68, and Inverter external fault selection 08-24=0 or 1.		
EF4 External fault (S4) 	External fault (Terminal S4) Active when 03-03= 25 or 68, and Inverter external fault selection 08-24=0 or 1.		
EF5 External fault (S5) 	External fault (Terminal S5) Active when 03-04= 25 or 68, and Inverter external fault selection 08-24=0 or 1.		
EF6 External fault (S6) 	External fault (Terminal S6) Active when 03-05= 25 or 68, and Inverter external fault selection 08-24=0 or 1.		
EF7 External fault (S7) 	External fault (Terminal S7) Active when 03-06= 25 or 68, and Inverter external fault selection 08-24=0 or 1.		
EF8 External fault (S8) 	External fault (Terminal S8) Active when 03-07= 25 or 68, and Inverter external fault selection 08-24=0 or 1.		

LED display	Description	Possible causes	Corrective action
CF07 Motor control fault CF07	Motor control fault	<ul style="list-style-type: none"> <li>• SLV mode is unable to run motor.</li> </ul>	<ul style="list-style-type: none"> <li>• Perform rotational or stationary auto-tune</li> <li>• Increase minimum output frequency (01-08)</li> </ul>
CF08 Motor control fault CF08	Motor control fault	<ul style="list-style-type: none"> <li>• Start or Run fault in PMSLV mode.</li> </ul>	<ul style="list-style-type: none"> <li>• Increase the value of 22-10 properly.</li> <li>• Re auto-tune (22-21)</li> <li>• Check if the load is too heavy to raise torque output limit.</li> </ul>
CF00 Operator Communication Error CF00	Errors of data transmission occur in LCD keypad.	<ul style="list-style-type: none"> <li>• LCD keypad and inverter cannot transmit data after power on 5 seconds.</li> </ul>	<ul style="list-style-type: none"> <li>• Disconnect the operator and then reconnect.</li> <li>• Replace the control board</li> </ul>
CF01 Operator Communication Error 2 CF01	Errors of data transmission occur in LCD keypad.	<ul style="list-style-type: none"> <li>• LCD keypad and inverter can transmit data but transmission error occurs for more than 2 seconds</li> </ul>	<ul style="list-style-type: none"> <li>• Disconnect the operator and then reconnect.</li> <li>• Replace the control board</li> </ul>
CTER CT Failure CTER	Errors of detecting voltages from three phase's current transformer to detect output current.	<ul style="list-style-type: none"> <li>• Errors of detecting voltages</li> <li>• Noises too much</li> <li>• Control board failure</li> </ul>	<ul style="list-style-type: none"> <li>• Check current transformer signal and the voltage on the control board.</li> </ul>
CF20 Communication Failure CF20	Use Profibus & Modbus Communication at the same time.	<ul style="list-style-type: none"> <li>• Maybe use two kind of communication type at the same time.</li> </ul>	<ul style="list-style-type: none"> <li>• Check only use one kind of communication type.</li> </ul>
PF Protection Fault PF	OH1 error occurs for 3 times in 5 minutes when run command in multi-function digital input terminals is not removed.	<ul style="list-style-type: none"> <li>• Run command in multi-function digital input terminals is not removed.</li> </ul>	<ul style="list-style-type: none"> <li>• Remove run command in multi-function digital input terminals.</li> </ul>
TOL External Overload TOL	External overload (enabled only when firemode activated)	<ul style="list-style-type: none"> <li>• External overload in multi-function digital input terminals. (Ex. Fan overheat)</li> </ul>	<ul style="list-style-type: none"> <li>• Check external overload.</li> <li>• Reset external overload of digital input.</li> </ul>

## 10.3 Warning / Self-diagnosis Detection Function

When the inverter detects a warning, the keypad displays a warning code (flash).

**Note:** The fault contact output does not energize on a warning and the inverter continues operation. When the warning is no longer active the keypad will return to its original state.

When the inverter detected a programming error (for example two parameters contradict each other or are set to an invalid setting), the keypad displays a self-diagnostics code.







**Note:** The fault contact output does not energize on a self-diagnostics error. While a self-diagnostics code is active the inverter does not accept a run command until the programming error is corrected.





**Note:** When a warning or self-diagnostic error is active the warning or error code will flash on the keypad. When the RESET key is pressed, the warning message (flash) disappears and returns after 5 sec. If the warning or self-diagnostic error still exists.





Refer to Table 10.3.1 for an overview, cause and corrective action for inverter warnings and self-diagnostic errors.

**Table 10.3.1 warning / self-diagnosis and corrective actions**





LED display	Description	Possible causes	Corrective action
<p><b>OV</b> (flash) <b>Over voltage</b></p>	<p><b>DC bus voltage exceeds the OV detection level:</b> 200V class: 410Vdc 400V class: 820Vdc 575V class: 1050Vdc 690V class: 1230Vdc (for 400V class, if input voltage 01-14 is set lower than 400V, the OV detection value will be decreased to 700Vdc)</p>	<ul style="list-style-type: none"> <li>• Deceleration time set too short, resulting in regenerative energy flowing back from motor to the inverter.</li> <li>• The inverter input voltage is too high.</li> <li>• Use of power factor correction capacitors.</li> <li>• Excessive braking load.</li> <li>• Braking transistor or resistor defective.</li> <li>• Speed search parameters set incorrectly.</li> </ul>	<ul style="list-style-type: none"> <li>• Increase deceleration time</li> <li>• Reduce input voltage to comply with the input voltage requirements or install an AC line reactor to lower the input voltage.</li> <li>• Remove the power factor correction capacitor.</li> <li>• Use dynamic braking unit.</li> <li>• Replace braking transistor or resistor.</li> <li>• Adjust speed search parameters.</li> </ul>
	<p>DC bus voltage is lower than the UV detection level or the pre-charge contactor is not active while the inverter is running. 190Vdc: 200V class; 380Vdc: 400V class 546Vdc: 575/690V class (the detection value can be adjusted by 07-13)</p>	<ul style="list-style-type: none"> <li>• The input voltage is too low.</li> <li>• Input phase loss.</li> <li>• Acceleration time set too short.</li> <li>• Input voltage fluctuation.</li> <li>• Pre-charge contactor damaged.</li> <li>• DC bus voltage feedback signal value not correct.</li> </ul>	<ul style="list-style-type: none"> <li>• Check the input voltage.</li> <li>• Check input wiring.</li> <li>• Increase acceleration time.</li> <li>• Check power source</li> <li>• Replace pre-charge contactor</li> <li>• Replace control board or complete inverter.</li> </ul>







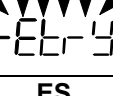

LED display	Description	Possible causes	Corrective action
<p><b>OH1</b> <b>Heatsink</b> <b>overheat</b></p> 	<p>The temperature of the heat sink is too high. Note: when OH1 fault occurs three times within five minutes, it is required to wait 10 minutes before resetting the fault.</p>	<ul style="list-style-type: none"> <li>• Ambient temperature too high.</li> <li>• cooling fan failed</li> <li>• Carrier frequency set too high.</li> <li>• Load too heavy.</li> </ul>	<ul style="list-style-type: none"> <li>• Install fan or AC to cool surroundings.</li> <li>• Replace cooling fan.</li> <li>• Reduce carrier frequency.</li> <li>• Reduce load / Measure output current</li> </ul>
<p><b>OH2</b> <b>(flash)</b> <b>Inverter over</b> <b>heating</b> <b>warning</b></p> 	<p>Inverter overheat warning Multi-function digital input set to 31. (Terminal S1 ~ S8) Active when 03-00 ~ 03-07 = 31).</p>	<ul style="list-style-type: none"> <li>• Multifunction digital input overheat warning active</li> </ul>	<ul style="list-style-type: none"> <li>• Multi-function input function set incorrectly.</li> <li>• Check wiring</li> </ul>
<p><b>OT</b> <b>(flash)</b> <b>over torque</b> <b>detection</b></p> 	<p>Inverter output torque is higher than 08-15 (over torque detection level) for the time specified in 08-16. Parameter 08-14 = 0 to activate.</p>	<ul style="list-style-type: none"> <li>• Load too heavy.</li> </ul>	<ul style="list-style-type: none"> <li>• Check over torque detection parameters (08-15 / 08-16).</li> <li>• Check and reduce motor load, check and operation duty cycle.</li> </ul>
<p><b>UT</b> <b>(flash)</b> <b>under torque</b> <b>detection</b></p> 	<p>Inverter output torque is lower than 08-19 (under torque detection level) for the time specified in 08-20. Parameter 08-18 = 0 to activate.</p>	<ul style="list-style-type: none"> <li>• Sudden drop in load.</li> <li>• Belt break.</li> </ul>	<ul style="list-style-type: none"> <li>• Check under torque detection parameters (08-19 / 08-20).</li> <li>• Check load / application.</li> </ul>
<p><b>bb1</b> <b>(flash)</b> <b>External</b> <b>baseblock</b></p> 	<p>External base block (Terminal S1)</p>		
<p><b>bb2</b> <b>(flash)</b> <b>External</b> <b>baseblock</b></p> 	<p>External base block (Terminal S2)</p>	<ul style="list-style-type: none"> <li>• Multifunction digital input external baseblock active.</li> </ul>	<ul style="list-style-type: none"> <li>• Multi-function input function set incorrectly.</li> <li>• Check wiring</li> </ul>
<p><b>bb3</b> <b>(flash)</b> <b>External</b> <b>baseblock</b></p> 	<p>External base block (Terminal S3)</p>		





LED display	Description	Possible causes	Corrective action
<b>bb4</b> <b>(flash)</b> <b>External</b> <b>baseblock</b> 	External base block (Terminal S4)		
<b>bb5</b> <b>(flash)</b> <b>External</b> <b>baseblock</b> 	External base block (Terminal S5)		
<b>bb6</b> <b>(flash)</b> <b>External</b> <b>baseblock</b> 	External base block (Terminal S6)	<ul style="list-style-type: none"> <li>• Multifunction digital input external baseblock active.</li> </ul>	<ul style="list-style-type: none"> <li>• Multi-function input function set incorrectly.</li> <li>• Check wiring</li> </ul>
<b>bb7</b> <b>(flash)</b> <b>External</b> <b>baseblock</b> 	External base block (Terminal S7)		
<b>bb8</b> <b>(flash)</b> <b>External</b> <b>baseblock</b> 	External base block (Terminal S8)		







LED display	Description	Possible causes	Corrective action
<b>OS</b> <b>(flash)</b> <b>Motor over speed</b>	Motor speed exceeds level set in 20-20 (PG Over speed Level) for the time set in 20-21 (PG over speed time). Active when 20-19 (= 0 or 1). This fault is active V/F + PG and SV control mode (00-00 = 1 or 3 or 4). Motor speed can be monitored by 12-22	<ul style="list-style-type: none"> <li>• Motor speed overshoot (ASR)</li> <li>• PG ppr set incorrectly.</li> <li>• Overspeed parameters set incorrectly.</li> </ul>	<ul style="list-style-type: none"> <li>• Check ASR parameters group 21.</li> <li>• Check PG parameters</li> <li>• Check overspeed parameters 20-20/20-12.</li> </ul>
			
<b>PGO</b> <b>(flash)</b> <b>PG open circuit</b>	PG pulses are not received by the inverter for the time specified in 20-26 (PG open circuit detection time). This fault is active V/F + PG and SV control mode (00-00 = 1 or 3 or 4).	<ul style="list-style-type: none"> <li>• PG cable disconnected.</li> <li>• PG has no power.</li> <li>• Mechanical brake active preventing motor from turning.</li> </ul>	<ul style="list-style-type: none"> <li>• Check PG wiring.</li> <li>• Check PG power-supply.</li> <li>• Make sure brake is released.</li> </ul>
			
<b>DEV</b> <b>(flash)</b> <b>Speed deviation</b>	Motor speed rises above 20-23 level (PG speed deviation level) for the time specified in 20-24 (PG deviation time). Active when parameter 20-22(=0 or 1). This fault is active V/F + PG and SV control mode (00-00 = 1 or 3 or 4).	<ul style="list-style-type: none"> <li>• Load too heavy</li> <li>• Mechanical brake active preventing motor from turning.</li> <li>• PG wiring error.</li> <li>• PG parameters (group 20) set incorrectly.</li> <li>• Acceleration / deceleration time set to short.</li> </ul>	<ul style="list-style-type: none"> <li>• Check load</li> <li>• Make sure brake is released.</li> <li>• Check PG wiring.</li> <li>• Check PG parameters 20-23/20-24.</li> <li>• Increase Acceleration / deceleration time.</li> </ul>
			
<b>OL1</b> <b>Motor overload</b>	Internal motor overload protection tripped, active when protection curve 08-05 = xxx1.	<ul style="list-style-type: none"> <li>• Voltage setting V/F mode too high, resulting in over-excitation of the motor.</li> <li>• Motor rated current (02-01) set incorrectly.</li> <li>• Load too heavy.</li> </ul>	<ul style="list-style-type: none"> <li>• Check V/f curve.</li> <li>• Check motor rated current</li> <li>• Check and reduce motor load, check and operation duty cycle.</li> </ul>
			
<b>OL2</b> <b>Inverter overload</b>	Inverter thermal overload protection tripped. If an inverter overload occurs 4 times in five minutes, it is required to wait 4 minutes before resetting the fault.	<ul style="list-style-type: none"> <li>• Voltage setting V/F mode too high, resulting in over-excitation of the motor.</li> <li>• Inverter rating too small.</li> <li>• Load too heavy.</li> </ul>	<ul style="list-style-type: none"> <li>• Check V/f curve.</li> <li>• Replace inverter with larger rating.</li> <li>• Check and reduce motor load, check and operation duty cycle.</li> </ul>
			













LED display	Description	Possible causes	Corrective action
<b>CE</b> <b>(flash)</b> <b>communication error</b>	No Modbus communication received for 2 sec. Active when 09-07=3.	<ul style="list-style-type: none"> <li>• Connection lost or wire broken.</li> <li>• Host stopped communicating.</li> </ul>	<ul style="list-style-type: none"> <li>• Check connection</li> <li>• Check host computer / software.</li> </ul>
			
<b>CLA</b> <b>over current protection level A</b>	Inverter current reaches the current protection level A.	<ul style="list-style-type: none"> <li>• Inverter current too high.</li> <li>• Load too heavy.</li> </ul>	<ul style="list-style-type: none"> <li>• Check load and duty cycle operation.</li> </ul>
			
<b>CLB</b> <b>over current protection level B</b>	Inverter current reaches the current protection level B.	<ul style="list-style-type: none"> <li>• Inverter current too high.</li> <li>• Load too heavy.</li> </ul>	<ul style="list-style-type: none"> <li>• Check load and duty cycle operation.</li> </ul>
			
<b>Retry</b> <b>(flash)</b> <b>retry</b>	Automatic reset activated, warning is displayed until restart delay time set (07-01) expires.	<ul style="list-style-type: none"> <li>• Parameter 07-01 set to a value greater than 0.</li> <li>• Parameter 07-02 set to a value greater than 0.</li> </ul>	<ul style="list-style-type: none"> <li>• Warning disappears after automatic reset.</li> </ul>
			
<b>ES</b> <b>(flash)</b> <b>External emergency stop</b>	External emergency stop Enabled.	<ul style="list-style-type: none"> <li>• 03-00~03-08 set to 14, and the digital input enabled.</li> </ul>	<ul style="list-style-type: none"> <li>• Turn off run command, and remove external emergency stop command.</li> </ul>
			

LED display	Description	Possible causes	Corrective action
<b>EF1 ( flash )</b> <b>External fault</b> <b>(S1)</b> 	External fault (Terminal S1) Active when 03-00= 25 or 68, and Inverter external fault selection 08-24=2.	<ul style="list-style-type: none"> <li>• Multifunction digital input external fault active and parameter 08-24 = 2 for operation to continue.</li> </ul>	<ul style="list-style-type: none"> <li>• Multi-function input function set incorrectly.</li> <li>• Check wiring</li> <li>• Multi-function input function set incorrectly.</li> <li>• Check wiring</li> </ul>
<b>EF2 ( flash )</b> <b>External fault</b> <b>(S2)</b> 	External fault (Terminal S2) Active when 03-01= 25 or 68, and Inverter external fault selection 08-24=2.		
<b>EF3 ( flash )</b> <b>External fault</b> <b>(S3)</b> 	External fault (Terminal S3) Active when 03-02= 25 or 68, and Inverter external fault selection 08-24=2.		
<b>EF4 ( flash )</b> <b>External fault</b> <b>(S4)</b> 	External fault (Terminal S4) Active when 03-03= 25 or 68, and Inverter external fault selection 08-24=2.		
<b>EF5 ( flash )</b> <b>External fault</b> <b>(S5)</b> 	External fault (Terminal S5) Active when 03-04= 25 or 68, and Inverter external fault selection 08-24=2.		
<b>EF6 ( flash )</b> <b>External fault</b> <b>(S6)</b> 	External fault (Terminal S6) Active when 03-05= 25 or 68, and Inverter external fault selection 08-24=2.		
<b>EF7 ( flash )</b> <b>External fault</b> <b>(S7)</b> 	External fault (Terminal S7) Active when 03-06= 25 or 68, and Inverter external fault selection 08-24=2.		
<b>EF8 ( flash )</b> <b>External fault</b> <b>(S8)</b> 	External fault (Terminal S8) Active when 03-07= 25 or 68, and Inverter external fault selection 08-24=2.		

LED display	Description	Possible causes	Corrective action
<b>EF9 ( flash ) error of forward/revers al rotation</b> 	Forward run and reverse run are active within 0.5 sec of each other. Stop method set by parameter 07-09.	<ul style="list-style-type: none"> <li>Forward run and reverse run active (see 2-wire control).</li> </ul>	<ul style="list-style-type: none"> <li>Check run command wiring</li> </ul>
<b>SE01 Rang setting error</b> 	Parameter setting falls outside the allowed range.	<ul style="list-style-type: none"> <li>Some parameter ranges are determined by other inverter parameters which could cause an out of range warning when the dependency parameter is adjusted. Example: 1.02-00&gt;02-01, or 20&gt;02-21 2.00-12&gt;00-13, 3.00-07 = 1,00-05=00-06 4.02-03 &gt; 02-06 or 02-22 &gt; 02-25 5.20-16 &lt; 20-15</li> </ul>	<ul style="list-style-type: none"> <li>Check parameter setting.</li> </ul>
<b>SE02 Digital input terminal error</b> 	Multi-function input setting error.	<ul style="list-style-type: none"> <li>Multi-function digital input terminals (03-00 to 03-07) are set to the same function (not including ext. fault and not used.) or ①UP/DOWN commands are not set at the same time( they must be used together). ②UP/DOWN commands (08 and 09) and ACC/DEC commands (11) are set at the same time. ③Speed search 1(19, maximum frequency) and Speed search 2 (34, from the set frequency) are set at the same time. 03-00~03-07 set two-wire and three-wire in the same time.</li> </ul>	<ul style="list-style-type: none"> <li>Check multi-function input setting.</li> </ul>
<b>SE03 V/f curve error</b> 	V/f curve setting error.	<ul style="list-style-type: none"> <li>V/F curve setting error. ① 01-02 &gt; 01-12 &gt; 01-06 &gt;01-08; • (Fmax) (Fbase) (Fmid1) (Fmin) ②01-16 &gt; 01-24 &gt; 01-20 &gt; 01-22; • (Fmax2) (Fbase2)(Fmid1) (Fmin2)</li> </ul>	<ul style="list-style-type: none"> <li>Check V/F parameters</li> </ul>
<b>SE05 PID selection error</b> 	PID selection error.	<ul style="list-style-type: none"> <li>10-00 and 10-01 set to 1(AI1) or set to 2(AI2)</li> <li>10-29 = 1 or 2 and 10-25 = 1 allow to reverse.</li> <li>10-29 = 1 or 2 and 10-03 =1xxxb(PID output+ target value)</li> </ul>	<ul style="list-style-type: none"> <li>Check 10-00 and 10-01</li> <li>Check 10-29 and 10-25</li> <li>Check 10-29 and 10-03</li> </ul>

LED display	Description	Possible causes	Corrective action
<b>HPErr</b> <b>Model</b> <b>selection</b> <b>error</b> 	Inverter capacity setting error: Inverter capacity setting 13-00 does not match the rated voltage.	<ul style="list-style-type: none"> <li>Inverter capacity setting does not match voltage class (13-00).</li> </ul>	<ul style="list-style-type: none"> <li>Check inverter capacity setting 13-00.</li> </ul>
<b>SE07</b> <b>PG card error</b> 	Inverter PG card setting error.	<ul style="list-style-type: none"> <li>No PG feedback card installed.</li> <li>Set wrong type for PM Encoder Type (22-08)</li> </ul>	<ul style="list-style-type: none"> <li>Install PG feedback card.</li> <li>Check control mode.</li> <li>Set right type for PM Encoder Type (22-08) and power on again.</li> </ul>
<b>SE08</b> <b>PM Motor</b> <b>mode error</b> 	Inverter rating does not support the PM Motor mode.	<ul style="list-style-type: none"> <li>Inverter rating does not support PM motor control mode.</li> </ul>	<ul style="list-style-type: none"> <li>Check control mode.</li> </ul>
<b>SE09</b> <b>PI setting</b> <b>error</b> 	Inverter PI setting error	<ul style="list-style-type: none"> <li>Inverter pulse input selection (03-30) selection conflicts with PID source (10-00 and 10-01).</li> </ul>	<ul style="list-style-type: none"> <li>Check pulse input selection (03-30) and PID source (10-00 and 10-01).</li> </ul>
<b>FB</b> <b>(flash)</b> <b>PID feedback</b> <b>breaking</b> 	PID feedback signal falls below level specified in 10-12 (PID feedback loss detection level) for the time specified in 10-13 (Feedback loss detection time). Active when parameter (10-11 = 1).	<ul style="list-style-type: none"> <li>Feedback signal wire broken</li> <li>Feedback sensor broken.</li> </ul>	<ul style="list-style-type: none"> <li>Check feedback wiring</li> <li>Replace feedback sensor.</li> </ul>
<b>USP</b> <b>(flash)</b> <b>Unattended</b> <b>Start</b> <b>Protection</b> 	Unattended Start Protection (USP) is enabled (enabled at power-up.)	<ul style="list-style-type: none"> <li>USP at power-up (activated by multi-function digital input) is enabled. The inverter will not accept a run command.</li> <li>While the warning is active the inverter does not accept a run command. (See parameter 03-00 - 03-08 = 50).</li> </ul>	<ul style="list-style-type: none"> <li>Remove run command or reset inverter via multi-function digital input (03-00 to 03-07 = 17) or use the RESET key on the keypad to reset inverter.</li> <li>Activate USP input and re-apply the power.</li> </ul>
<b>STP0</b> <b>Zero Speed</b> <b>Stop Error</b> 	Frequency command is smaller than 01-08 without DC brake.	<ul style="list-style-type: none"> <li>Frequency command is smaller than motor minimum output frequency.</li> </ul>	<ul style="list-style-type: none"> <li>Adjust frequency command</li> </ul>

LED display	Description	Possible causes	Corrective action
<b>STP2</b> <b>External</b> <b>Terminal</b> <b>Stop Error</b> 	External Terminal is main run command source selection (00-02=1) and run command executes but executes stop command from keypad.	<ul style="list-style-type: none"> <li>Run command executes from external terminal but executes stop command from keypad.</li> </ul>	<ul style="list-style-type: none"> <li>Remove the run command from external terminal</li> </ul>
<b>EnC</b> <b>Encoder Error</b> 	PG card is connected but encoder signal error is detected when motor auto rotational tuning is running.	<ul style="list-style-type: none"> <li>Abnormal encoder signal</li> </ul>	<ul style="list-style-type: none"> <li>Check encoder wiring</li> <li>17-07 PG pulse number setting is not corresponding to the encoder.</li> <li>Replace the encoder.</li> </ul>
<b>RunEr</b> <b>Wrong</b> <b>running</b> <b>direction</b> <b>Error</b> 	Running direction is different from 11-00	<ul style="list-style-type: none"> <li>Check the command among 11-00, jog and DI control to see if any difference.</li> </ul>	<ul style="list-style-type: none"> <li>Revise the command among 11-00, jog and DI control to see if any difference</li> </ul>
<b>PArEr</b> <b>Parameter</b> <b>setting error</b> 	Parameter setting error	<ul style="list-style-type: none"> <li>The parameter setting is wrong</li> </ul>	<ul style="list-style-type: none"> <li>Please refer to the manual for correct setting</li> </ul>
<b>STP1</b> <b>Direct start</b> <b>warning</b> 	The inverter can't start directly, due to 07-04=1	<ul style="list-style-type: none"> <li>Run command from the terminal is enabled and 07-04=1</li> </ul>	<ul style="list-style-type: none"> <li>Remove the run command from the terminal first, and enabled later.</li> </ul>
<b>FirE</b> <b>Fire mode</b> <b>enabled</b> 	Fire mode enabled	<ul style="list-style-type: none"> <li>Fire mode enabled.</li> </ul>	<ul style="list-style-type: none"> <li>Check the environment and confirm the fire status. If no fire, turn off the power and power on again.</li> </ul>
<b>AdCEr</b> <b>Voltage on</b> <b>C/B error</b> 	The voltage on the control board error	<ul style="list-style-type: none"> <li>Errors of detecting voltages</li> <li>Noises too much</li> <li>Control board failure</li> </ul>	<ul style="list-style-type: none"> <li>Check the voltage on the control board.</li> </ul>

LED display	Description	Possible causes	Corrective action
<b>EPerr</b> <b>EEPROM</b> <b>Save error</b> 	The data save in EEPROM is wrong.	<ul style="list-style-type: none"> <li>• EEPROM circuit failure</li> <li>• Parameter check error after power on</li> </ul>	<ul style="list-style-type: none"> <li>• Restore factory setting, then cut off the power and power on again.</li> <li>• If warning again, replace control board.</li> </ul>
<b>bdErr</b> <b>Control board</b> <b>error</b> 	Firmware can't meet Control board.	<ul style="list-style-type: none"> <li>• Firmware can't meet Control board.</li> </ul>	<ul style="list-style-type: none"> <li>• Replace the control board.</li> </ul>
<b>Parameter</b> <b>Lock</b> 	Parameter lock key code (password) already locked	<ul style="list-style-type: none"> <li>• Parameter lock key code already enable (13-07)</li> </ul>	<ul style="list-style-type: none"> <li>• Lifting the parameter lock key code, to enter the correct parameter for 13-07</li> </ul>
<b>Set password</b> <b>failed</b> 	Parameter lock key code cannot enable	<ul style="list-style-type: none"> <li>• To enable the parameter lock key code (password) function, but the password is not correct</li> </ul>	<ul style="list-style-type: none"> <li>• Enter the correct parameter for 13-07 to enable the parameter lock key</li> </ul>

## 10.4 Auto-tuning Error

When a fault occurs during auto-tuning of a standard AC motor, the display will show the “AtErr” fault and the motor stops. The fault information is displayed in parameter 17-11.

**Note:** The fault contact output does not energize with an auto-tuning fault. Refer to Table 10.4.1, for fault information during tuning, cause and corrective action.

**Table 10.4.1 Auto-tuning fault and corrective actions**

Error	Description	Cause	Corrective action
01	Motor data input error.	<ul style="list-style-type: none"> <li>Motor Input data error during auto-tuning.</li> <li>Inverter output current does not match motor rated current.</li> </ul>	<ul style="list-style-type: none"> <li>Check the motor tuning data (17-00 to 17-09).</li> <li>Check inverter capacity</li> </ul>
02	Motor lead to lead resistance R1 tuning error.	<ul style="list-style-type: none"> <li>Auto-tuning is not completed within the specified time</li> <li>Auto-tuning results fall outside parameter setting range.</li> <li>Motor rated current exceeded.</li> <li>Motor was disconnected.</li> </ul>	<ul style="list-style-type: none"> <li>Check the motor tuning data (17-00 to 17-09).</li> <li>Check motor connection.</li> <li>Disconnect motor load.</li> <li>Check inverter current detection circuit and DCCTs.</li> <li>Check motor installation.</li> </ul>
03	Motor leakage inductance tuning error.		
04	Motor rotor resistance R2 tuning error.		
05	Motor mutual inductance Lm tuning error.		
07	Deadtime compensation detection error		
06	Motor encoder error	<ul style="list-style-type: none"> <li>PG feedback noise</li> </ul>	<ul style="list-style-type: none"> <li>Check motor rated current.</li> <li>Check PG card grounding.</li> </ul>
08	Motor acceleration error (Rotational type auto-tuning only).	<ul style="list-style-type: none"> <li>Motor fails to accelerate in the specified time (00-14=20sec).</li> </ul>	<ul style="list-style-type: none"> <li>Increase acceleration time (00-14).</li> <li>Disconnect motor load.</li> </ul>
09	Other	<ul style="list-style-type: none"> <li>No load current is higher than 70% of the motor rated current.</li> <li>Torque reference exceeds 100%.</li> <li>Errors other than ATE01~ATE08.</li> </ul>	<ul style="list-style-type: none"> <li>Check the motor tuning data (17-00 to 17-09).</li> <li>Check motor connection.</li> </ul>

## 10.5 PM Motor Auto-tuning Error

When a fault occurs during auto-tuning of a PM motor, the display will show the “IPErr” fault and the motor stops. The fault information is displayed in parameter 22-18.

**Note:** The fault contact output does not energize with an auto-tuning fault. Refer to Table 10.5.1, for fault information during tuning, cause and corrective action.

**Table 10.5.1 Auto-tuning fault and corrective actions for PM motor**

Error	Description	Cause	Corrective action
01	Magnetic pole alignment tuning failure (static).	<ul style="list-style-type: none"> <li>Inverter output current does not match motor current.</li> </ul>	<ul style="list-style-type: none"> <li>Check the motor tuning data (22-02).</li> <li>Check inverter capacity</li> </ul>
02	PG option missing.	<ul style="list-style-type: none"> <li>Magnetic pole cannot be aligned without PG option card.</li> </ul>	<ul style="list-style-type: none"> <li>Install PG feedback card.</li> </ul>
03	Magnetic pole alignment auto-tuning abort during rotational auto-tune.	<ul style="list-style-type: none"> <li>System abnormality during magnetic pole alignment.</li> </ul>	<ul style="list-style-type: none"> <li>Check for active protection functions preventing auto-tuning.</li> </ul>
04	Timeout during magnetic pole alignment during rotational auto-tune.	<ul style="list-style-type: none"> <li>Motor cannot rotate</li> </ul>	<ul style="list-style-type: none"> <li>Check motor.</li> <li>Check motor wiring.</li> <li>Check brake released.</li> </ul>
05	Circuit tuning time out.	<ul style="list-style-type: none"> <li>System abnormality during circuit tuning.</li> </ul>	<ul style="list-style-type: none"> <li>Check for active protection functions preventing auto-tuning.</li> </ul>
06	Encoder error	<ul style="list-style-type: none"> <li>PG feedback noise</li> </ul>	<ul style="list-style-type: none"> <li>Check motor rated current.</li> <li>Check PG card grounding.</li> </ul>
07	Warning	<ul style="list-style-type: none"> <li>Other motor tuning error</li> </ul>	<ul style="list-style-type: none"> <li>Check the motor tuning data (22-02).</li> <li>Check motor connection.</li> </ul>
08	Motor current out of range during magnetic pole alignment (rotational auto-tune).	<ul style="list-style-type: none"> <li>Motor cannot operate at low speeds.</li> </ul>	<ul style="list-style-type: none"> <li>Check PG card wiring</li> <li>Check motor connection.</li> </ul>
09	Current out of range during circuit tuning.	<ul style="list-style-type: none"> <li>Inverter output current does not match motor current.</li> </ul>	<ul style="list-style-type: none"> <li>Check the motor tuning data (22-02).</li> <li>Check inverter capacity</li> </ul>
10	Magnetic pole alignment and circuit tuning failed.	<ul style="list-style-type: none"> <li>Auto-tuning is not successful.</li> </ul>	<ul style="list-style-type: none"> <li>Retry magnetic pole alignment and circuit tuning.</li> </ul>



## 10.6 General troubleshooting

Status	Checking point	Remedy
<b>Motor runs in wrong direction</b>	Is the wiring for the output terminals correct?	Wiring must match U, V, and W terminals of the motor.
	Is the wiring for forward and reverse signals correct?	Check for correct wiring.
<b>The motor speed can not be regulated.</b>	Is the wiring for the analog frequency inputs correct?	Check for correct wiring.
	Is the setting of operation mode correct?	Check the Frequency Source set in parameters 00-05/00-06.
	Is the load too excessive?	Reduce the load.
<b>Motor running speed too high or too low</b>	Check the motor specifications (poles, voltage...) correct?	Confirm the motor specifications.
	Is the gear ratio correct?	Confirm the gear ratio.
	Is the setting of the highest output frequency correct?	Confirm the highest output frequency
<b>Motor speed varies unusually</b>	Is the load too excessive?	Reduce the load.
	Does the load vary excessively?	1.Minimize the variation of the load. 2.Consider increasing the capacities of the inverter and the motor.
	Is the input power unstable or is there a phase loss ?	1.Consider adding an AC reactor at the power input side if using single-phase power. 2.Check wiring if using three-phase power
<b>Motor can not run</b>	Is the power connected to the correct L1, L2, and L3 terminals? is the charging indicator lit ?	1.Is the power applied? 2.Turn the power OFF and then ON again. 3.Make sure the power voltage is correct. 4.Make sure screws are secured firmly.
	Is there voltage across the output terminals T1, T2, and T3?	Turn the power OFF and then ON again.
	Is overload causing the motor to stall?	Reduce the load so the motor will run.
	Are there any abnormalities in the inverter?	See error descriptions to check wiring and correct if necessary.
	Is there a forward or reverse run command ?	
	Has the analog frequency signal been input?	1.Is analog frequency input signal wiring correct? 2.Is voltage of frequency input correct?
	Is the operation mode setting correct?	Operate through the digital keypad

## 10.7 Troubleshooting of the Inverter

### 10.7.1 Quick troubleshooting of the Inverter

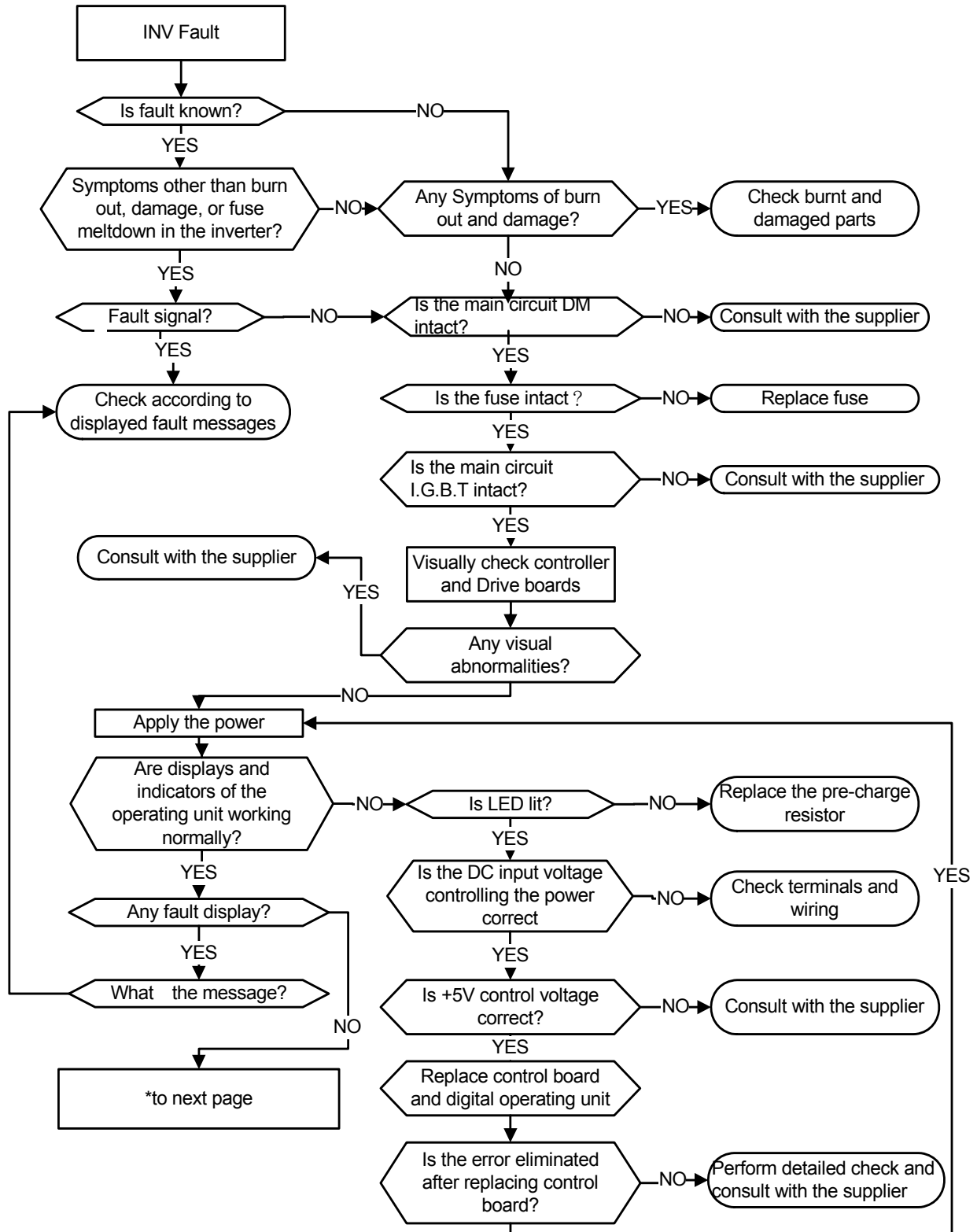

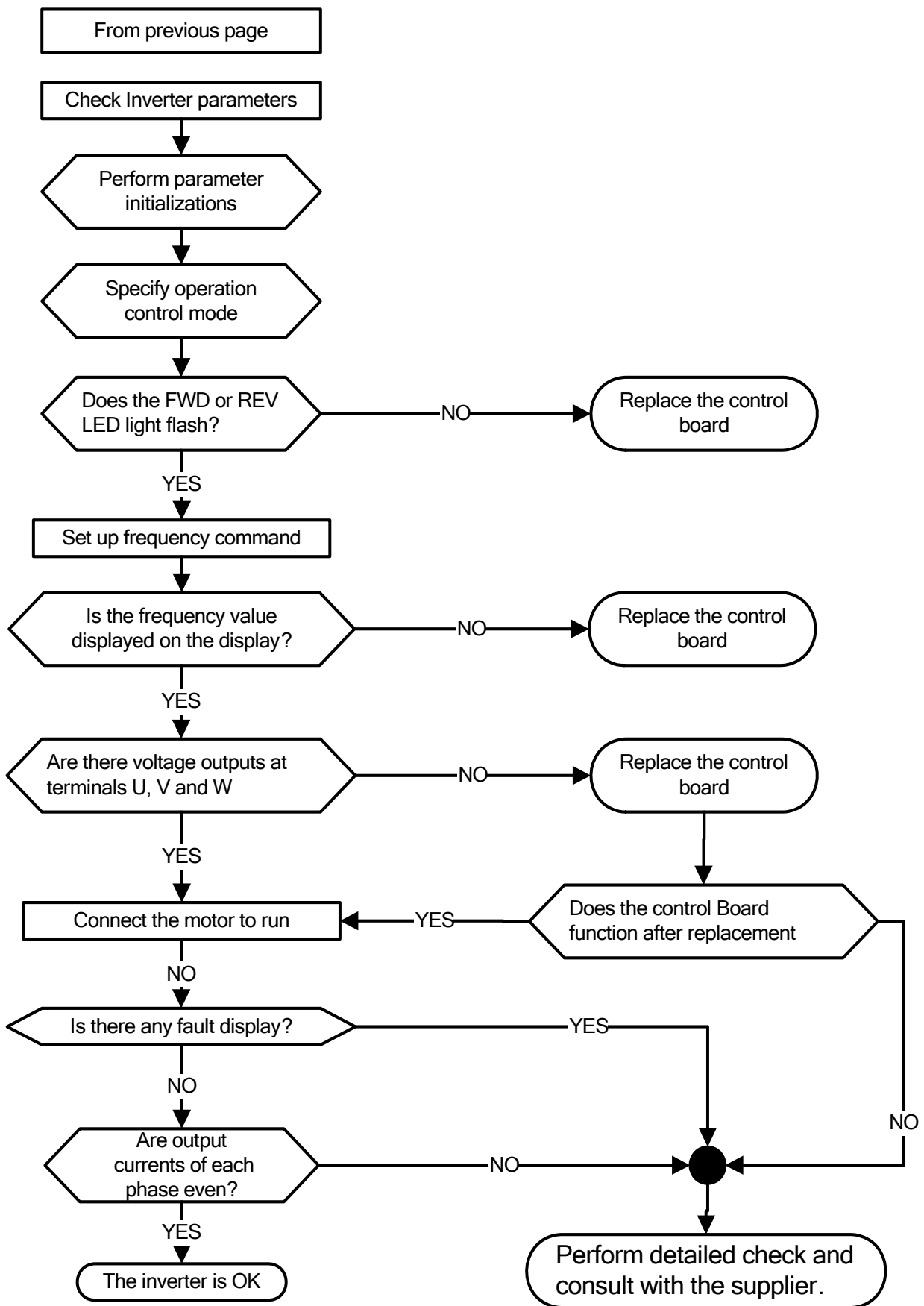

## 10.7.2 Troubleshooting for OC, OL error displays

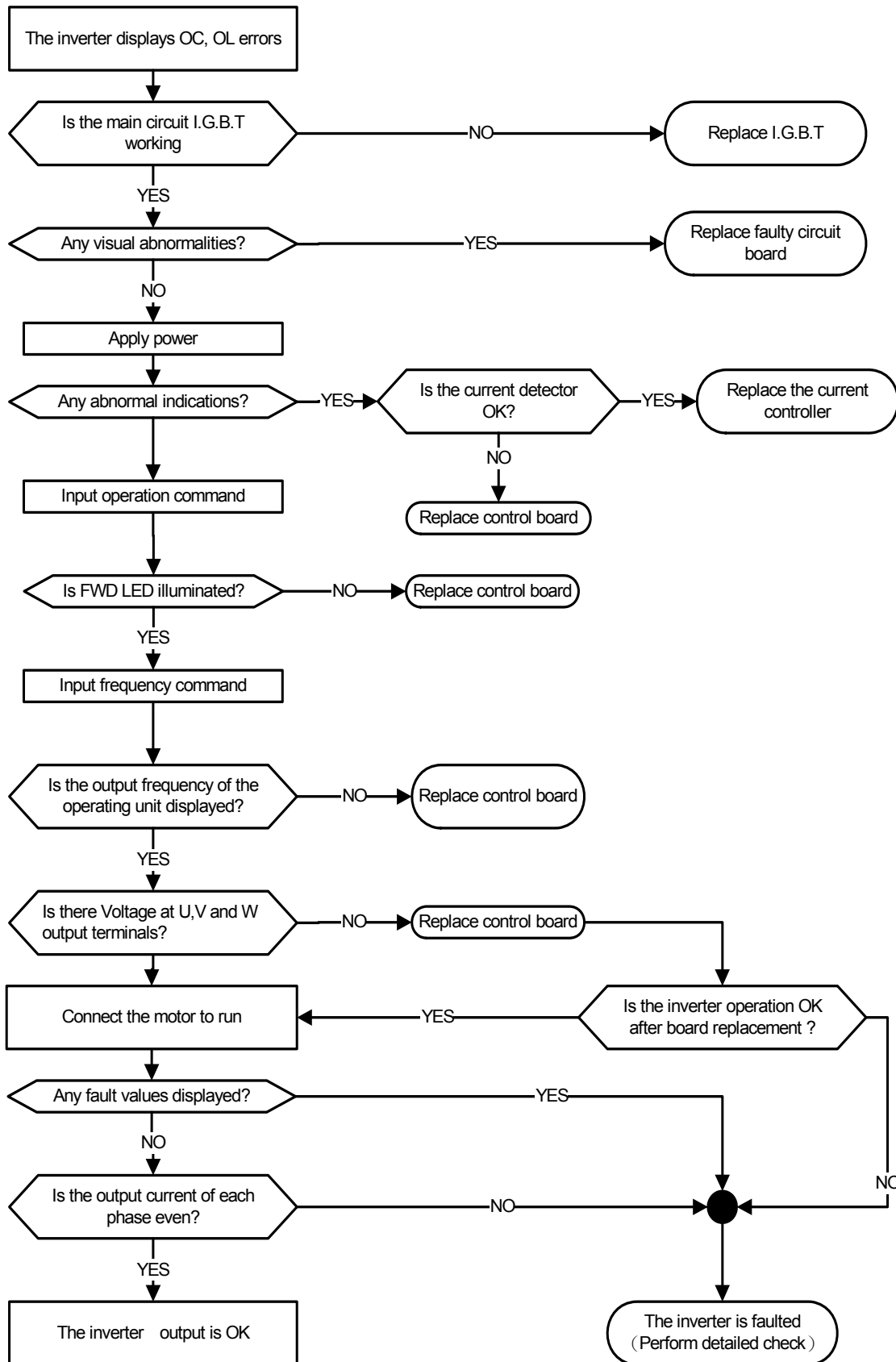

### 10.7.3 Troubleshooting for OV, LV error

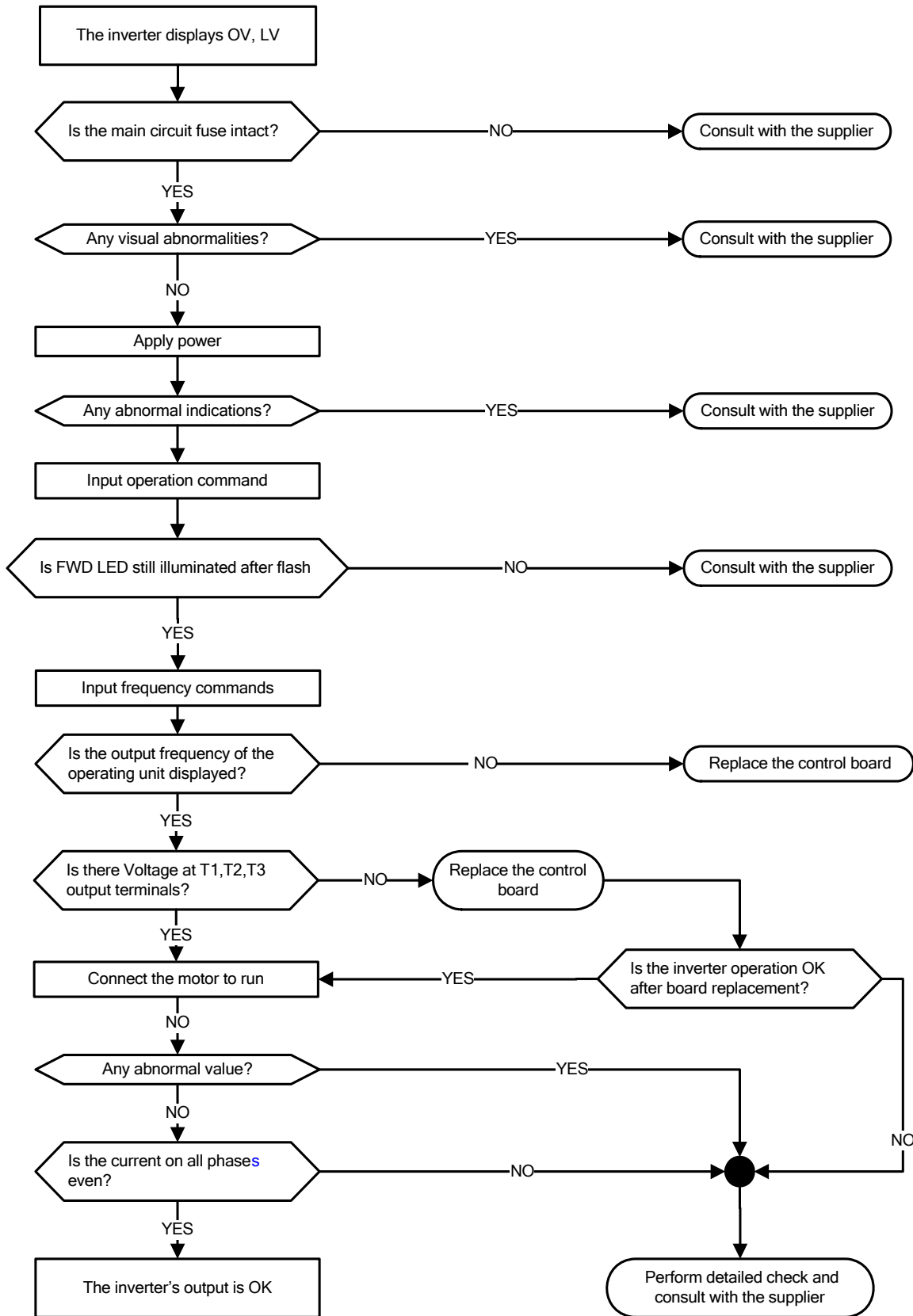

### 10.7.4 The motor can not run

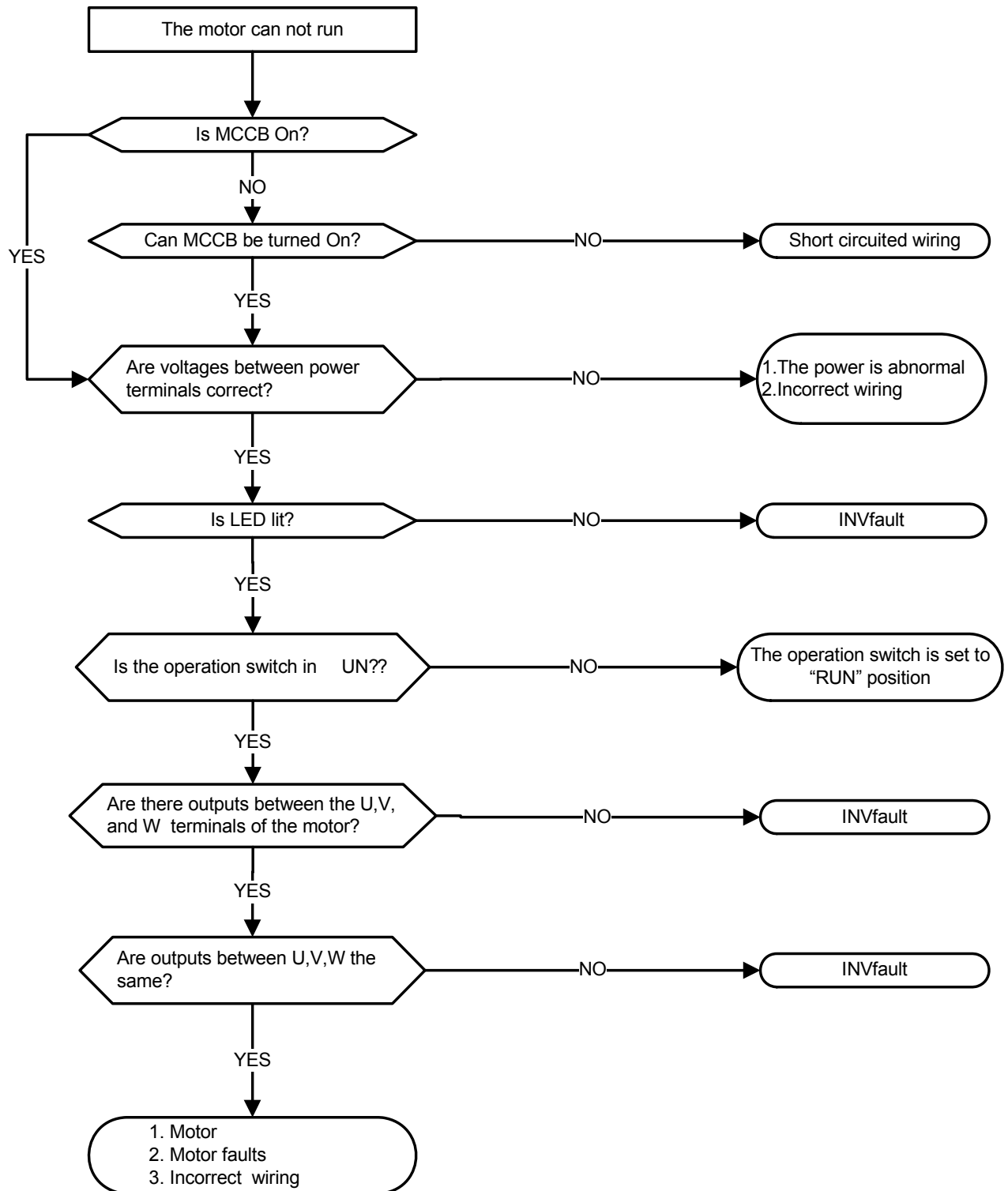

## 10.7.5 Motor Overheating

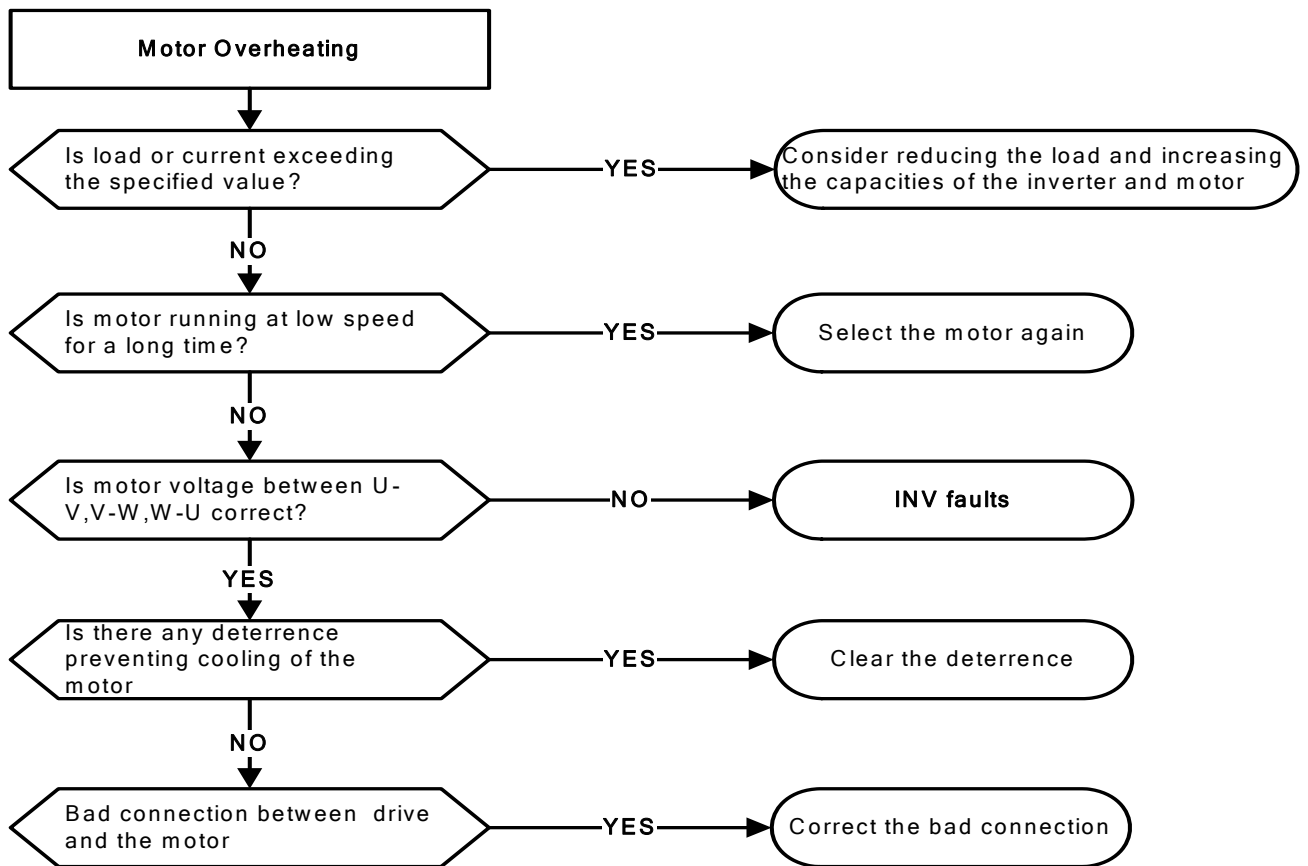

### 10.7.6 Motor runs unbalanced

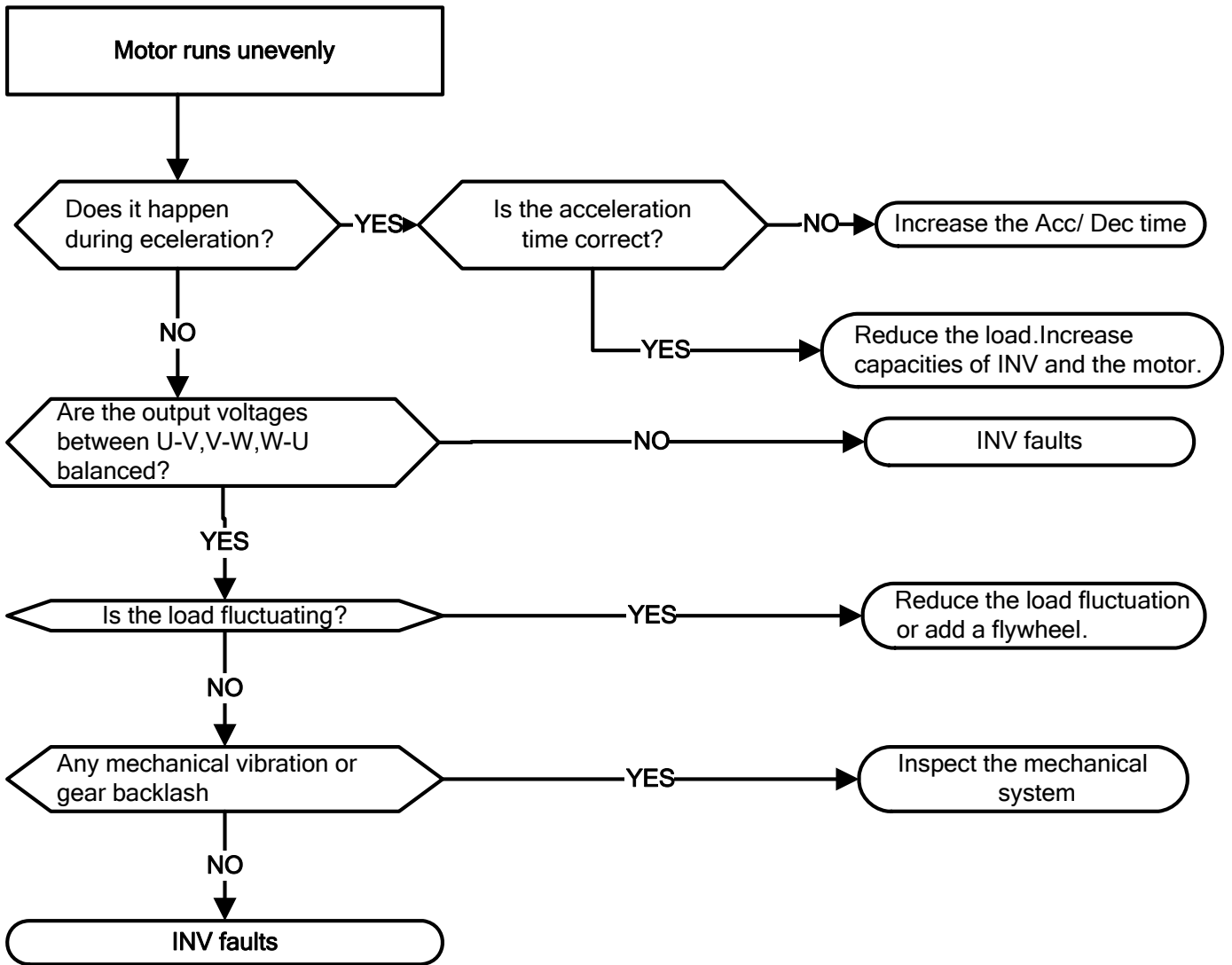



## 10.8 Routine and periodic inspection

To ensure stable and safe operations, check and maintain the inverter at regular intervals.

Use the checklist below to carry out inspection.

Disconnect power after approximately 5 minutes to make sure no voltage is present on the output terminals before any inspection or maintenance.

Items	Details	Checking period		Methods	Criteria	Remedies
		Daily	1Year			
<b>Environment &amp; Ground connection</b>						
Ambient conditions at the installation	Confirm the temperature and humidity at the machine	☉		Measure with thermometer and hygrometer	Temperature: -10 ~40°C/50°C (14~104°F)/(122°F) Humidity: Below 95%RH	Improve the ambient or relocate the drive to a better area.
Installation Grounding	Is the grounding resistance correct?		☉	Measure the resistance with a multi-tester	200Vclass: below 100Ω	Improve the grounding if needed.
<b>Terminals &amp; Wiring</b>						
Connection terminals	Any loose parts or terminals?		☉	Visual check Check with a screwdriver	Correct installation requirement	Secure terminals and remove rust
	Any damage to the base ?		☉			
	Any corroded Terminals?		☉			
Wiring	Any broken wires?		☉	Visual check	Correct wiring requirement	Rectify as necessary
	Any damage to the wire insulation?		☉			
<b>voltage</b>						
Input power voltage	Is the voltage of the main circuit correct?	☉		Measure the voltage with a multi-tester	Voltage must conform with the spec.	Improve input voltage if necessary.
<b>Circuit boards and components</b>						
Printed circuit board	Any contamination or damage to printed circuit board?		☉	Visual check	Correct component condition	Clean or replace the circuit board
Power component	Any dust or debris		☉			
		Check resistance between terminals		☉	Measure with a multi-tester	No short circuit or broken circuit in three phase output
<b>Cooling System</b>						
Cooling fan	Unusual vibration and noise?		☉	Visual and sound check	Correct cooling	Consult with the supplier
	Excessive dust or debris	☉		Visual check		Clean the fan
Heat sink	Excessive dust or debris	☉				Clean up debris or dust
Ventilation Path	Is the ventilation path blocked?	☉				

## 10.9 Maintenance

To ensure long-term reliability, follow the instructions below to perform regular inspection. Turn the power off and wait for a minimum of 5 minutes before inspection to avoid potential shock hazard from the charge stored in high-capacity capacitors.

### 1. Maintenance Check List.

➤ Ensure that temperature and humidity around the inverters is as required in the instruction manual, installed away from any sources of heat and the correct ventilation is provided..
➤ For replacement of a failed or damaged inverter consult with the local supplier.
➤ Ensure that the installation area is free from dust and any other contamination.
➤ Check and ensure that the ground connections are secure and correct.
➤ Terminal screws must be tight, especially on the power input and output of the inverter.
➤ Do not perform any insulation test on the control circuit.

### 2. Insulation test Method . Single Phase

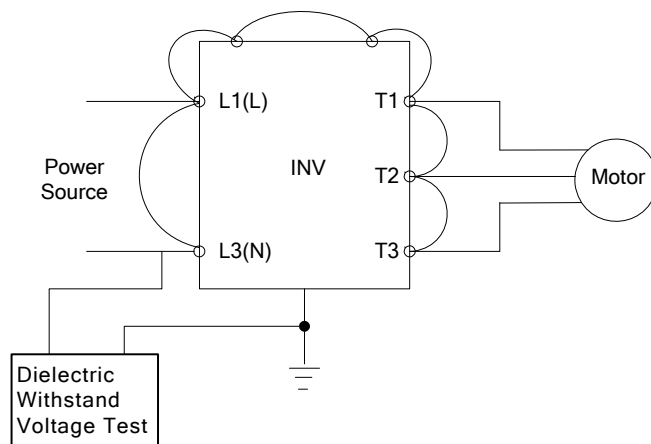

### Three Phase

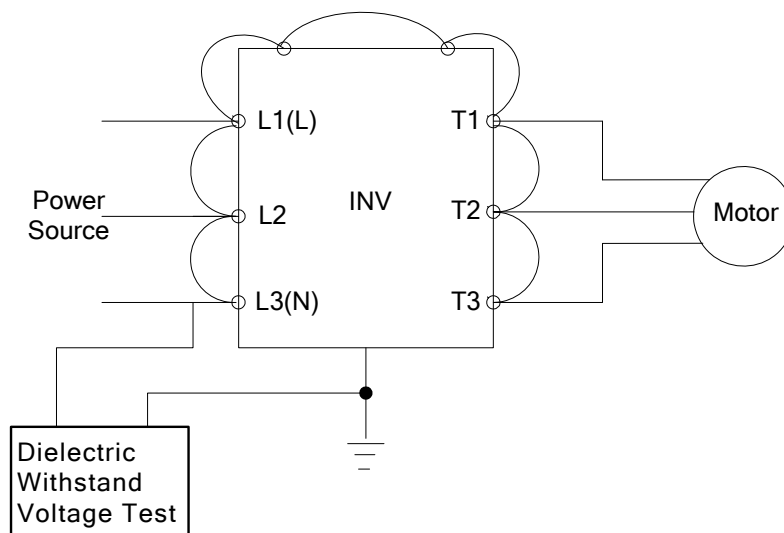

# Chapter 11 Inverter Peripheral devices and Options

## 11.1 Braking Resistors and Braking Units

Inverters ratings 200V 1~25HP / 400V 1~40HP(For Standard H & C type) / 400V 1~30HP(For Enhanced E & G type) / 575V 1~10HP/ 690V 15~40HP have a built-in braking transistor. For applications requiring a greater braking torque an external braking resistor can be connected to terminals B1 / P and B2; for inverter ratings above 200V 30HP / 400V 50HP(For Standard H & C type) / / 400V 40HP(For Enhanced E & G type) / 600V 50HP, an external braking unit (connected to  $\oplus$  -  $\ominus$  of the inverter) and a braking resistor (connected to two ends of the detection module BR $\oplus$  - BR $\ominus$ ) is required.

**Table 11.1.1 List of braking resistors and braking units**

Inverter			Braking unit		Braking resistor					Braking torque (Peak / Continues) 10%ED	Minimum Resistance*1	
Input Voltage	HP	KW	Model	Qty Req.	Part Number	Resistor specification	Qty Req. (set)	Resistor Spec.(W/ $\Omega$ ) & Dimensions (L*W*H)mm	Qty Req. (pcs)		( $\Omega$ )	(W)
200V 1 $\emptyset$ /3 $\emptyset$	1	0.75	-	-	JNBR-100W200	100W/200 $\Omega$	1	100W/200 $\Omega$ (196*28*60)	1	119%	17 $\Omega$	1000W
	2	1.5	-	-	JNBR-200W100	200W/100 $\Omega$	1	200W/100 $\Omega$ (274*35*76)	1	119%	17 $\Omega$	1000W
	3	2.2	-	-	JNBR-260W70	260W/70 $\Omega$	1	260W/70 $\Omega$ (274*40*78)	1	115%	17 $\Omega$	1000W
200V 3 $\emptyset$	5	3.7	-	-	JNBR-450W40	450W/40 $\Omega$	1	450W/40 $\Omega$ (320*40*78)	1	119%	17 $\Omega$	1000W
	7.5	5.5	-	-	JNBR-600W28	600W/28 $\Omega$	1	600W/28 $\Omega$ (395*40*78)	1	115%	17 $\Omega$	1000W
	10	7.5	-	-	JNBR-900W20	900W/20 $\Omega$	1	900W/20 $\Omega$ (470*50*100)	1	119%	10.2 $\Omega$	1800W
	15	11	-	-	JNBR-1R5KW13R6	1500W/13.6 $\Omega$	1	1500W/13.6 $\Omega$ (615*60*110)	1	117%	10.2 $\Omega$	1800W
	20	15	-	-	JNBR-2KW10	2000W/10 $\Omega$	1	2000W/10 $\Omega$ (722*65*115)	1	119%	6.8 $\Omega$	2600W
	25	18.5	-	-	JNBR-2R4KW8	2400W/8 $\Omega$	1	1200W/16 $\Omega$ (535*60*110)	2 parallel	119%	6.8 $\Omega$	2600W
	30	22	JNTBU-230	1	JNBR-3KW6R8	3000W/6.8 $\Omega$	1	1500W/13.6 $\Omega$ (615*60*110)	2 parallel	120%	5.5 $\Omega$	3300W
	40	30	JNTBU-230	2	JNBR-2KW10	2000W/10 $\Omega$	2	2000W/10 $\Omega$ (722*65*115)	1	122%	5.5 $\Omega$	3300W
	50	37	JNTBU-230	2	JNBR-2KW10	2000W/10 $\Omega$	2	2000W/10 $\Omega$ (722*65*115)	1	102%	5.5 $\Omega$	3300W
			JNTBU-260	1	JNBR-6KW5	6000W/5 $\Omega$	1	1500W/20 $\Omega$ (615*60*110)	4 parallel	105%	3.8 $\Omega$	4500W
60	45	JNTBU-230	2	JNBR-3KW6R8	3000W/6.8 $\Omega$	2	1500W/13.6 $\Omega$ (615*60*110)	2 parallel	120%	5.5 $\Omega$	3300W	

Inverter			Braking unit		Braking resistor					Braking torque (Peak / Continues) 10%ED	Minimum Resistance*1		
Input Voltage	HP	KW	Model	Qty Req.	Part Number	Resistor specification	Qty Req. (set)	Resistor Spec.(W/Ω) & Dimensions (L*W*H)mm	Qty Req. (pcs)		(Ω)	(W)	
400V 3 Ø	75	55	JNTBU-260	1	JNBR-7R5KW4	7500W/4Ω	1	1500W/20Ω (615*60*110)	5 parallel	106%	3.8Ω	4500W	
			JNTBU-230	2	JNBR-3KW6R8	3000W/6.8Ω	2	1500W/13.6Ω (615*60*110)	2 parallel	100%	5.5Ω	3300W	
	100	75	JNTBU-260	2	JNBR-4R5KW6R6	4500W/6.6Ω	2	1500W/20Ω (615*60*110)	3 parallel	106%	3.8Ω	4500W	
			JNTBU-230	3	JNBR-3KW6R8	3000W/6.8Ω	3	1500W/13.6Ω (615*60*110)	2 parallel	110%	5.5Ω	3300W	
	125	90	JNTBU-260	2	JNBR-6KW5	6000W/5Ω	2	1500W/20Ω (615*60*110)	4 parallel	107%	3.8Ω	4500W	
			JNTBU-230	4	JNBR-3KW6R8	3000W/6.8Ω	4	1500W/13.6Ω (615*60*110)	2 parallel	116%	5.5Ω	3300W	
	150	110	JNTBU-260	2	JNBR-7R5KW4	7500W/4Ω	2	1500W/20Ω (615*60*110)	5 parallel	110%	3.8Ω	4500W	
			JNTBU-230	4	JNBR-3KW6R8	3000W/6.8Ω	4	1500W/13.6Ω (615*60*110)	2 parallel	100%	5.5Ω	3300W	
	400V 3 Ø	1	0.75	-	-	JNBR-100W750	100W/750Ω	1	100W/750Ω (196*28*60)	1	126%	110Ω	700W
		2	1.5	-	-	JNBR-200W400	200W/400Ω	1	200W/400Ω (274*35*76)	1	120%	110Ω	700W
		3	2.2	-	-	JNBR-300W250	300W/250Ω	1	300W/250Ω (320*40*78)	1	126%	93Ω	800W
		5	3.7	-	-	JNBR-500W150	500W/150Ω	1	500W/150Ω (400*50*100)	1	126%	68Ω	1100W
7.5		5.5	-	-	JNBR-700W110	700W/110Ω	1	700W/110Ω (530*50*100)	1	117%	41Ω	1800W	
10		7.5	-	-	JNBR-900W80	900W/80Ω	1	900W/80Ω (470*50*100)	1	120%	41Ω	1800W	
15		11	-	-	JNBR-1R6KW50	1600W/50Ω	1	1600W/50Ω (615*60*110)	1	126%	41Ω	1800W	
20		15	-	-	JNBR-2KW40	2000W/40Ω	1	2000W/40Ω (722*65*115)	1	120%	20.5Ω	3500W	
25		18.5	-	-	JNBR-2R4KW32	2400W/32Ω	1	1200W/64Ω (535*60*110)	2 parallel	120%	13.5Ω	5300W	
30		22	-	-	JNBR-3KW27R2	3000W/27.2Ω	1	1500W/13.6Ω (615*60*110)	2 in series	118%	13.5Ω	5300W	
40		30	JNTBU-430	2	JNBR-4KW20	4000W/20Ω	1	2000W/40Ω (722*65*115)	2 parallel	120%	19.2Ω	3800W	
50		37	JNTBU-430	2	JNBR-2R4KW32	2400W/32Ω	2	1200W/64Ω (535*60*110)	2 parallel	122%	19.2Ω	3800W	

Inverter			Braking unit		Braking resistor					Braking torque (Peak / Continues) 10%ED	Minimum Resistance*1	
Input Voltage	HP	KW	Model	Qty Req.	Part Number	Resistor specification	Qty Req. (set)	Resistor Spec.(W/Ω) & Dimensions (L*W*H)mm	Qty Req. (pcs)		(Ω)	(W)
75	55	JNTBU-430	2	JNBR-4KW20	4000W/20Ω	2	2000W/40Ω (722*65*115)	2 parallel	129%		19.2Ω	3800W
100	75	JNTBU-430	3	JNBR-3KW27R2	3000W/27.2Ω	3	1500W/13.6Ω (615*60*110)	2 in series	110%		19.2Ω	3800W
		JNTBU-4120	1	JNBR-9R6KW8R3	9600W/8.3Ω	1	1600W/50Ω (615*60*110)	6 parallel	122%		7.6Ω	9000W
125	90	JNTBU-430	3	JNBR-4KW20	4000W/20Ω	3	2000W/10Ω (722*65*115)	2 in series	118%		19.2Ω	3800W
		JNTBU-4120	1	JNBR-11R2KW7R2	11200W/7.2Ω	1	1600W/50Ω (615*60*110)	7 parallel	118%		7.6Ω	9000W
150	110	JNTBU-430	4	JNBR-4KW20	4000W/20Ω	4	2000W/10Ω (722*65*115)	2 in series	129%		19.2Ω	3800W
		JNTBU-4120	2	JNBR-6R4KW12R5	6400W/12.5Ω	2	1600W/50Ω (615*60*110)	4 parallel	113%		7.6Ω	9000W
175	132	JNTBU-430	4	JNBR-4KW20	4000W/20Ω	4	2000W/10Ω (722*65*115)	2 in series	113%		19.2Ω	3800W
		JNTBU-4120	2	JNBR-8KW10	8000W/10Ω	2	1600W/50Ω (615*60*110)	5 parallel	117%		7.6Ω	9000W
215	160	JNTBU-430	5	JNBR-4KW20	4000W/20Ω	5	2000W/10Ω (722*65*115)	2 in series	115%		19.2Ω	3800W
		JNTBU-4120	2	JNBR-9R6KW8R3	9600W/8.3Ω	2	1600W/50Ω (615*60*110)	6 parallel	124%		7.6Ω	9000W
270	200	JNTBU-430	6	JNBR-4KW20	4000W/20Ω	6	2000W/10Ω (722*65*115)	2 in series	111%		19.2Ω	3800W
		JNTBU-4120	2	JNBR-11R2KW7R2	11200W/7.2Ω	2	1600W/50Ω (615*60*110)	7 parallel	115%		7.6Ω	9000W
300	220	JNTBU-430	6	JNBR-4KW20	4000W/20Ω	6	2000W/10Ω (722*65*115)	2 in series	102%		19.2Ω	3800W
		JNTBU-4120	3	JNBR-9R6KW8R3	9600W/8.3Ω	3	1600W/50Ω (615*60*110)	6 parallel	122%		7.6Ω	9000W
375	280	JNTBU-430	8	JNBR-4KW20	4000W/20Ω	8	2000W/10Ω (722*65*115)	2 in series	107%	19.2Ω	3800W	
		JNTBU-4120	3	JNBR-9R6KW8R3	9600W/8.3Ω	3	1600W/50Ω (615*60*110)	6 parallel	105%	7.6Ω	9000W	
425	315	JNTBU-430	9	JNBR-4KW20	4000W/20Ω	9	2000W/10Ω (722*65*115)	2 in series	107%	19.2Ω	3800W	
		JNTBU-4120	4	JNBR-8KW10	8000W/10Ω	4	1600W/50Ω (615*60*110)	5 parallel	104%	7.6Ω	9000W	

A510-4040-S□3-B model, please follow the table as below.

Inverter			Braking unit		Braking resistor					Braking torque (Peak / Continues) 10%ED	Minimum Resistance*1	
Input Voltage	HP	KW	Model	Qty Req.	Part Number	Resistor specification	Qty Req. (set)	Resistor Spec.(W/Ω) & Dimensions (L*W*H)mm	Qty Req. (pcs)		(Ω)	(W)
400V 3Ø	40	30			JNBR-4KW20	4000W/20Ω	1	2000W/40Ω (722*65*115)	2 parallel	120%	9.6Ω	7600W

\*1: Minimum resistance is the acceptable minimum value of the braking resistor for a single braking unit.

Inverter			Braking unit		Braking resistor					Braking torque (Peak / Continues ) 10%ED	Minimum Resistance*1	
Input Voltage	HP	KW	Model	Qty Req.	Part Number	Resistor specification	Qty Req. (set)	Spec for one Resistor and dimensions (L*W*H) mm	Qty Req. (pcs)		(Ω)	(W)
575V 3Φ	1	0.75	-	-	-	150W/1400Ω	1		1	120%	130Ω	1600W
	2	1.5	-	-	-	250W/800Ω	1		1	120%	130Ω	1600W
	3	2.2	-	-	-	350W/600Ω	1		1	120%	130Ω	1600W
	5	3.7	-	-	-	600W/350Ω	1		1	120%	130Ω	1600W
	7.5	5.5	-	-	-	850W/240Ω	1		1	120%	130Ω	1600W
690V 3Φ	15	11	-	-	-	1600W/150Ω	1		1	120%	25Ω	10000W
	20	15	-	-	-	2400W/110Ω	1		1	120%	25Ω	10000W
	25	18.5	-	-	-	3000W/90Ω	1	-	1	120%	25Ω	10000W
	30	22	-	-	-	3300W/80Ω	1	-	1	120%	25Ω	10000W
	40	30	-	-	-	4400W/60Ω	1	-	1	120%	25Ω	10000W

\*1: Minimum resistance is the acceptable minimum value of the braking resistor for a single braking unit.

**Note1:** All resistors must be installed outside the drive module in a place where they can dissipate heat.

**Note2:** The surface temperature of the resistor is very high and air flowing from the resistor is very hot. Materials near the brake resistor must be non-flammable. Provide protection from accidental contact with the resistor

## 11.2 AC Line Reactors

An AC line reactor can be used for any of the following:

- Capacity of power system is much larger than the inverter rating.
- Inverter mounted close to the power system (in 33ft / 10 meters).
- Reduce harmonic contribution (improve power factor) back to the power line.
- Protect inverter input diode front-end by reducing short-circuit current.
- Minimize overvoltage trips due to voltage transients.

Please select the AC line reactor based on the inverter rating according to the following table.

**Table 11.2.1 List of AC Line Reactors**

Input Voltage	Model		AC reactor	
	HP	Rated Current(A) HD/ND	Inductance Value (mH)	Rated Current(A)
200V 1Ø/3Ø	1	5/6	1.7	15
	2	8/9.6	1.1	20
	3	11/12	0.85	25
200V 3Ø	5.4	17.5/22	0.46	25
	7.5	25/30	0.34	40
	10	33/42	0.24	50
	15	47/56	0.18	70
	20	60/69	0.15	85
	25	73/79	0.13	95
	30	85/110	0.09	140
	40	115/138	0.07	170
	50	145/169	0.06	210
	60	180/200	0.05	250
	75	215/250	0.04	310
	100	283/312	0.03	390
	125	346/400	0.03	490
150	415/450	0.02	550	

**Table 11.2.1 List of AC Line Reactors (continued)**

Input Voltage	Model		AC reactor	
	HP	Rated Current(A) HD/ND	Inductance Value (mH)	Rated Current(A)
400V 3Ø	1	3.4/4.1	4.9	5
	2	4.2/5.4	3.7	6.5
	3	5.5/6.9	2.9	8.5
	5.4	9.2/12.1	1.7	15
	7.5	14.8/17.5	1.2	25
	10	18/23	0.88	30
	15	24/31	0.65	40
	20	31/38	0.53	50
	25	39/44	0.46	55
	30	45/58	0.35	70
	40	60/73	0.28	90
	50	75/88	0.23	110
	60	91/103	0.2	130
	75	118/145	0.14	180
	100	150/168	0.12	210
	125	180/208	0.1	260
	150	216/250	0.08	310
	175	260/296	0.07	360
	215	295/328	0.06	400
	270	370/435	0.05	550
300	450/515	0.04	630	
375	523/585	0.04	720	
425	585/585	0.04	720	



**Table 11.2.1 List of AC Line Reactors (continued)**

Model			AC reactor	
Input Voltage	HP	Rated Current(A) HD/ND	Specification (mH)	Rated Current(A)
575V 3Ø	1	1.7/3.0	2.0	15
	2	3/4.2	2.0	15
	3	4.2/5.8	2.0	15
	5.4	6.6/8.8	2.0	15
	7.5	9.9/12.2	2.0	15
	10	11.4/14.5	2.0	15
690V 3Ø	15	15/19	1.5	35
	20	19/22	1.5	35
	25	22/27	1.5	35
	30	27/34	1.5	35
	40	34/42	0.84	60
	50	42/52	0.84	60
	60	54/62	0.84	60
	75	62/80	0.45	100
	100	86/99	0.45	100
	125	99/125	0.30	200
	150	131/147	0.30	200
	175	147/163	0.30	200
	215	163/212	0.30	200
	250	192/216	0.15	300
270	216/246	0.15	300	

**Note:** AC reactors listed in this table can only be used for the inverter input side. Do not connect AC reactor to the inverter output side. Both 200V class 50HP ~ 150HP and 400V class 100HP ~ 425HP and 600V class 100HP~300HP have a built-in DC reactors. If required by the application an AC reactor may be added.

## 11.3 Input Noise Filters

### A. Input Noise Filter on Specifications & Ratings

Install a noise filter on power supply side to eliminate noise transmitted between the power line and the inverter. The inverter noise filter shown in Table 11.4.1 below meets the EN61800-3 class A specification. 400V inverter class models can be ordered with integrated noise filter.

**Table 11.4.1 Input Noise Filter Specifications and Ratings**

Inverter size		Noise filter	
Input voltage	HP	Model	Dimension
200V 1Ø	1HP/2HP	FS32124-23-99	350*100*55
	3HP	FN3258-16-45	264*45*70
200V 3Ø	1HP/2HP	FN3258-16-45	264*45*70
	3HP	FN3258-16-45	264*45*70
	5HP	FS3258-42-47	330*50*85
	7.5HP	FN3258-42-47	330*50*85
	10HP	FS32123-40-99	330*85*90
	15HP	FS32125-56-99	318*80*135
	20HP/25HP	FS32125-79-99	360*95*90
	30HP/40HP	FS32125-138-99	320*226.5*86
	50HP/60HP	FS32125-211-99	320*226.5*86
	75HP/100HP	FS32125-312-99	320*226.5*86
	125HP/150HP	FN3270H-1000-99	610*230*132
400V 3Ø	1HP/2HP/3HP	JN5-FLT-8A	102*130*92
	5HP/7.5HP	JN5-FLT-19A	123*141*92
	10HP/15HP	JN5-FLT-33A	132*206*124
	20HP*1	FN3258-42-47	330*50*85
	20HP/25HP/30HP	JN5-FLT-63A	127*260*131
	40HP/50HP/60HP	JN5-FLT-112A	186*284*128
	75HP	FN3258-180-40	452*120*170
	100HP	FS32126-165-99	320*226.5*86
	125HP/150HP/175HP/215HP	FS32126-361-99	320*226.5*86
	270HP/300HP/375HP/425HP	FN3270H-1000-99	610*230*132

\*1: This model of 20 HP is not built-in filter. If customer would like to install the filter, the plug-in mode is allowable instead of the built-in mode.

Inverter size		Noise filter	
Input voltage	HP	Model	Dimension
575V 3Ø	1HP/2HP/3HP/5HP	FN258HV-7-29	255*50*126
	7.5HP/10HP	FN258HV-16-29	305*55*142
690V 3Ø	15HP/20HP/25HP/30HP	FN258HV-30-33	335*60*150
	40HP	FN258HV-42-33	329*70*185
	50HP/60HP	FN258HV-55-34	329*80*185
	75HP	FN258HV-75-34	329*80*220
	100HP/125HP	FN258HV-100-35	379*90*220
	150HP	FN258HV-130-35	439*110*240
	175HP	FN3359HV-150-28	300*210*120
	215HP	FN3359HV-180-28	300*210*120
	250HP/270HP	FN3359HV-250-28	300*230*125

## B. Input or Output Noise Filter (EMI Suppression Zero Phase Core)

- Part Number: 4H000D0250001
- Select a matched ferrite core to suppress EMI noise according to the required power rating and wire size.
- The ferrite core can attenuate high frequencies in the range of 100 kHz to 50 MHz, as shown in figure 11.4.1 below, and therefore should minimize the RFI generated by the inverter.
- The zero-sequence noise ferrite core can be installed either on the input side or on the output side. The wire around the core for each phase should be wound by following the same convention and in one direction. The more turns without resulting in saturation the better the attenuation. If the wire size is too large to be wound, all the wiring can be grouped and put through several cores together in one direction.

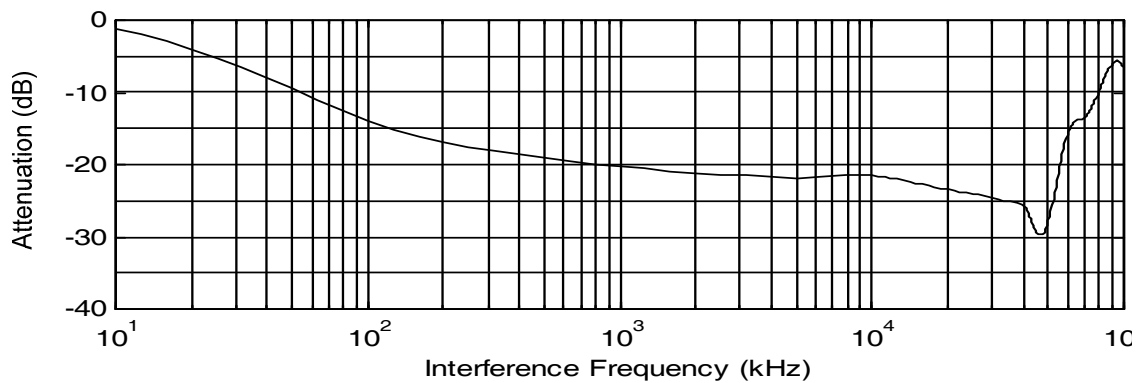

Fig. 11.4.1 Frequency attenuation characteristics (10 windings case)

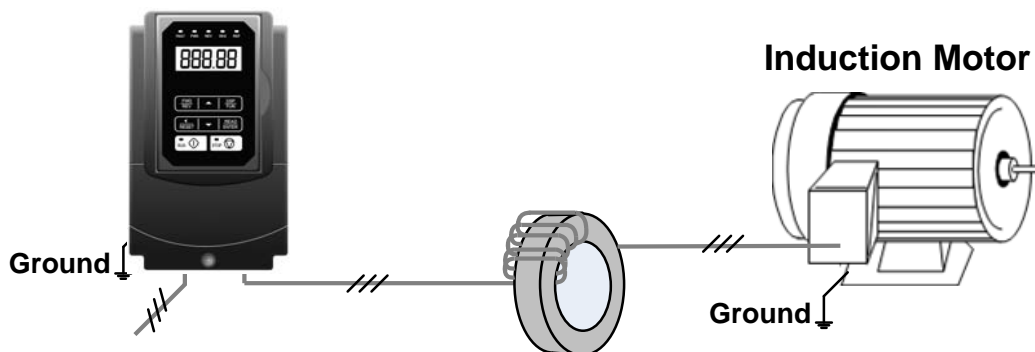

Fig. 11.4.2 Example of EMI Suppression Zero Phase Core Application

**Note:** All the wiring of phases U/T1, V/T2, W/T3 must pass through the same zero-phase core without crossing over.

## 11.4 Input Current and Fuse Specifications

### 200V class

Model	Horse power	KVA	100% of rated output current HD/ND	3 phases Rated input current HD/ND	Three-phase fuse rating	Single-phase rated input current HD/ND
A510-2001-S□	1	1.9	5/6	5.4/6.5	20	9.4/11.3
A510-2002-S□	2	3	8/9.6	8.5/10.3	30	14.7/17.9
A510-2003-S□	3	4.2	11/12	11.7/12.8	50	20.3/22.1
A510-2005-S□3	5	6.7	17.5/22	18.7/22.3	50	X
A510-2008-S□3	7.5	9.5	25/30	26.3/31.6	63	X
A510-2010-S□3	10	12.6	33/42	34.5/41.7	100	X
A510-2015-S□3	15	17.9	47/56	51.1/60.9	120	X
A510-2020-S□3	20	22.9	60/69	65.2/75	150	X
A510-2025-S□3	25	28.6	73/80	79.4/85.9	200	X
A510-2030-S□3	30	32.4	85/110	92.4/119.6	250	X
A510-2040-S□3	40	43.8	115/138	125/150	300	X
A510-2050-S□3	50	55.3	145/169	159/186	400	X
A510-2060-S□3	60	68.6	180/200	186/232	500	X
A510-2075-S□3	75	81.9	215/250	232/275	600	X
A510-2100-S□3	100	108	283/312	275/343	700	X
A510-2125-S□3	125	132	346/400	380/440	800	X
A510-2150-S□3	150	158	415/450	456/495	800	X

**400V class**

Model	Horse power	KVA	100% of rated output current HD/ND	Rated input current HD/ND	Fuse rating
A510-4001-S□3(F)	1	2.6	3.4/4.1	3.7/4.5	10
A510-4002-S□3(F)	2	3.2	4.2/5.4	5.3/5.9	16
A510-4003-S□3(F)	3	4.2	5.5/6.9	6.0/7.5	16
A510-4005-S□3(F)	5	7	9.2/12.1	9.6/11.6	25
A510-4008-S□3(F)	7.5	11.3	14.8/17.5	15.5/18.2	40
A510-4010-S□3(F)	10	13.7	18/23	18.7/24.0	50
A510-4015-S□3(F)	15	18.3	24/31	25.0/32.3	63
A510-4020-S□3(F)	20	23.6	31/38	33.7/41.3	80
A510-4025-S□3(F)	25	29.7	39/44	42.4/47.8	100
A510-4030-S□3(F)	30	34.3	45/58	48.9/58.7	120
A510-4040-S□3(F)	40	45.7	60/73	65.2/78.3	150
A510-4050-S□3(F)	50	57.2	75/88	81.5/95.7	200
A510-4060-S□3(F)	60	69.3	91/103	98.9/112	250
A510-4075-S□3	75	85.4	118/145	130/159	300
A510-4100-S□3	100	114	150/168	159/181	400
A510-4125-S□3	125	137	180/208	181/229	500
A510-4150-S□3	150	165	216/250	229/275	600
A510-4175-S□3	175	198	260/296	275/325	700
A510-4215-S□3	215	225	295/328	325/361	700
A510-4270-S□3	250	270	380/435	407/478	800
A510-4300-S□3	300	317	450/515	495/566	800
A510-4375-S□3	375	400	523/585	575/643	1000
A510-4425-S□3	425	446	585/585	643.5/643.5	1000

### 600V class

Model	Horse power	KVA	100% of rated output current HD/ND	Rated input current HD/ND	Fuse rating
A510-5001-S□3	1	1.7	1.7/3.0	1.7/3.0	10
A510-5002-S□3	2	3	3/4.2	3/4.2	10
A510-5003-S□3	3	4.2	4.2/5.8	4.2/5.8	10
A510-5005-S□3	5	6.6	6.6/8.8	6.6/8.8	15
A510-5008-S□3	7.5	9.9	9.9/12.2	9.9/12.2	20
A510-5010-S□3	10	11.4	11.4/14.5	11.4/14.5	20
A510-6015-S□3	15	17.9	15/19	15/19	30
A510-6020-S□3	20	22.7	19/22	19/22	40
A510-6025-S□3	25	26.3	22/27	22/27	40
A510-6030-S□3	30	32.3	27/34	27/34	50
A510-6040-S□3	40	40.	34/42	34/42	80
A510-6050-S□3	50	50.2	42/52	42/52	80
A510-6060-S□3	60	64.5	54/62	54/62	100
A510-6075-S□3	75	74.1	62/80	62/80	125
A510-6100-S□3	100	103	86/99	86/99	150
A510-6125-S□3	125	118	99/125	99/125	200
A510-6150-S□3	150	156	131/147	131/147	250
A510-6175-S□3	175	175	147/163	147/163	300
A510-6215-S□3	215	194	163/212	163/212	300
A510-6250-S□3	270	229	192/216	192/216	400
A510-6270-S□3	300	258	216/246	216/246	400

**Fuse type:** Choose semiconductor fuse to comply with UL.

**Voltage Range:**

For 200V class inverter, use 300V class fuse.

For 400V class inverter, use 600V class fuse.

## 11.5 PG Speed Feedback Card

ITEM	Encoder/Resolver Input Type	Output Type	Drive Installation (For Standard H&C type)	
			SIZE 1	>=SIZE 2
JN5-PG-O	Open collector feedback card	Open collector	YES	YES
JN5-PG-L	Line driver speed feedback card	Line Driver	YES	YES
JN5-PG-L-24	Line driver speed feedback card	Open collector	YES	YES
JN5-PG-PM	Synchronous motor line driver speed feedback card	Line Driver	No	YES
JN5-PG-PMR	Speed feedback card with TAMAGAWA Resolver	Line Driver	No	YES
JN5-PG-PMS	Speed feedback card with Heidenhain ERN 1387 Encoder Sin-Cos Incremental Encoder	Line Driver	No	YES
JN5-PG-PMS-24	Speed feedback card with Heidenhain ERN 1387 Encoder Sin-Cos Incremental Encoder	Open collector	No	YES
JN5-PG-PMC	Speed feedback card with Heidenhain ECN 1313 Encoder 8192 (13bits) Absolute Encoder	Line Driver	No	YES
JN5-PG-PMC-24	Speed feedback card with Heidenhain ECN 1313 Encoder 8192 (13bits) Absolute Encoder	Open collector	No	YES

Note: For Enhanced E & G type, all size of drive can support all the PG speed feedback card installation.

Refer to specified instruction manual for installation of each option card.

JN5-PG-O JN5-PG-L JN5-PG-L-24 JN5-PG-PM JN5-PG-PMR JN5-PG-PMS JN5-PG-PMS-24 JN5-PG-PMC JN5-PG-PMC-24	Wiring Size		24~16 AWG (0.205~1.31mm <sup>2</sup> )
	Torque	TB1	0.22~0.25 N.M
		TB2	0.2 N.M

Refer to the dedicated option card manual for installation instructions.

### A) JN5-PG-O speed feedback card: Open collector speed feedback card

JN5-PG-O terminal specification:

Terminal Name	Description
Vcc	Power supply for encoder. 12V or 5V $\pm$ 5%, 200mA Maximum (12V or 5V input voltage selected by the Switch Jumper. Can't use both 12V and 5V at the same time)
GND (0V Common Terminal)	
A, /A, B, /B, Z, /Z	Encoder input signal, two-phase input is required for correct divider ratio output. Open collector input type.
AO, /AO, BO, /BO, ZO, /ZO	A, B phase divider ratio output, z phase output monitor, Open collector type: 24V, 30mA.
E	Grounding Terminal.



**JN5-PG-O block diagram:**

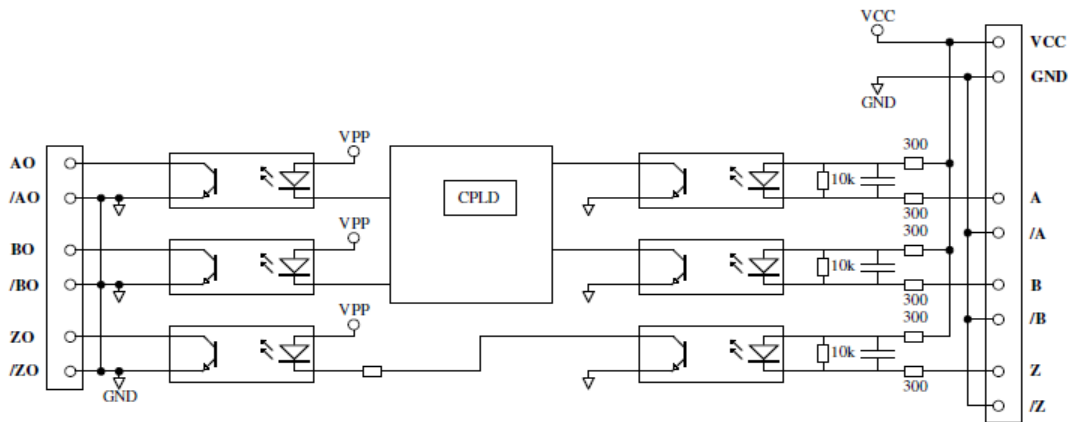

**B) JN5-PG-L / JN5-PG-L-24 speed feedback card: Line driver speed feedback card**

**JN5-PG-L / JN5-PG-L-24 terminal specification**

Terminal Name	Description
<b>Vcc</b>	Power supply for encoder. 12V or 5V $\pm 5\%$ , 200mA Maximum
<b>GND (0V Common Terminal)</b>	(12V or 5V input voltage selected by the Switch Jumper. Can't use both 12V and 5V at the same time)
<b>A, /A, B, /B, Z, /Z</b>	Encoder input signal, A correct divider ratio output requires a two-phase input. Line driver input type, RS-422 level input.
<b>AO, /AO, BO, /BO, ZO, /ZO</b>	A, B phase divider ratio output, z phase output monitor, Line driver output type, RS-422 level output.
<b>E</b>	Grounding terminal.

Note: The AO, /AO, BO, /BO, ZO, /ZO of JN5-PG-L-24 are open collector type output.

**JN5-PG-L / JN5-PG-L-24 block diagram:**

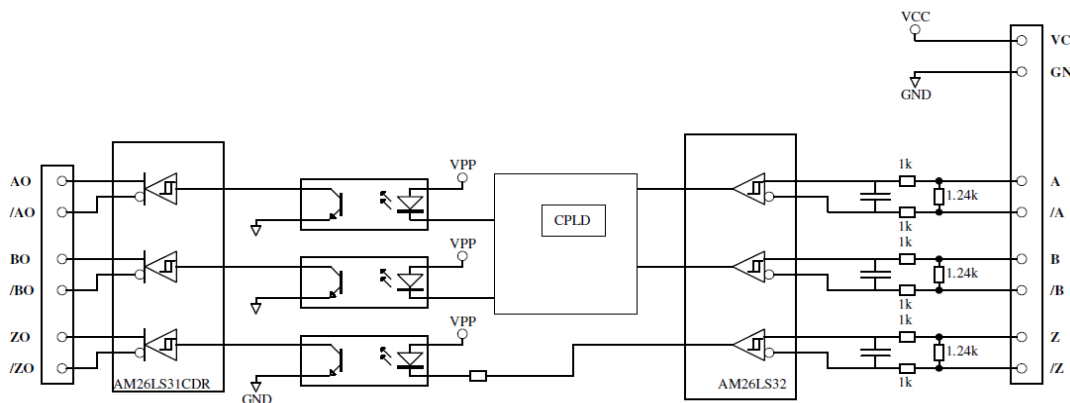

### C) JN5-PG-PM speed feedback card: synchronous motor line driver speed feedback card

#### JN5-PG-PM terminal specification

Terminal Name	Description
Vcc	Power supply for encoder.
GND (0V Common Terminal)	5V ±5%, 200mA Maximum
A, /A, B, /B, Z, /Z U, /U, V, /V, Z, /Z	Encoder input signal, A correct divider ratio output requires a two-phase input. Line driver input type, RS-422 level input.
AO, /AO, BO, /BO, ZO, /ZO	A ,B phase divider ratio output, z phase output monitor, Line driver output type, RS-422 level output.
E	Grounding terminal.

#### JN5-PG-PM block diagram:

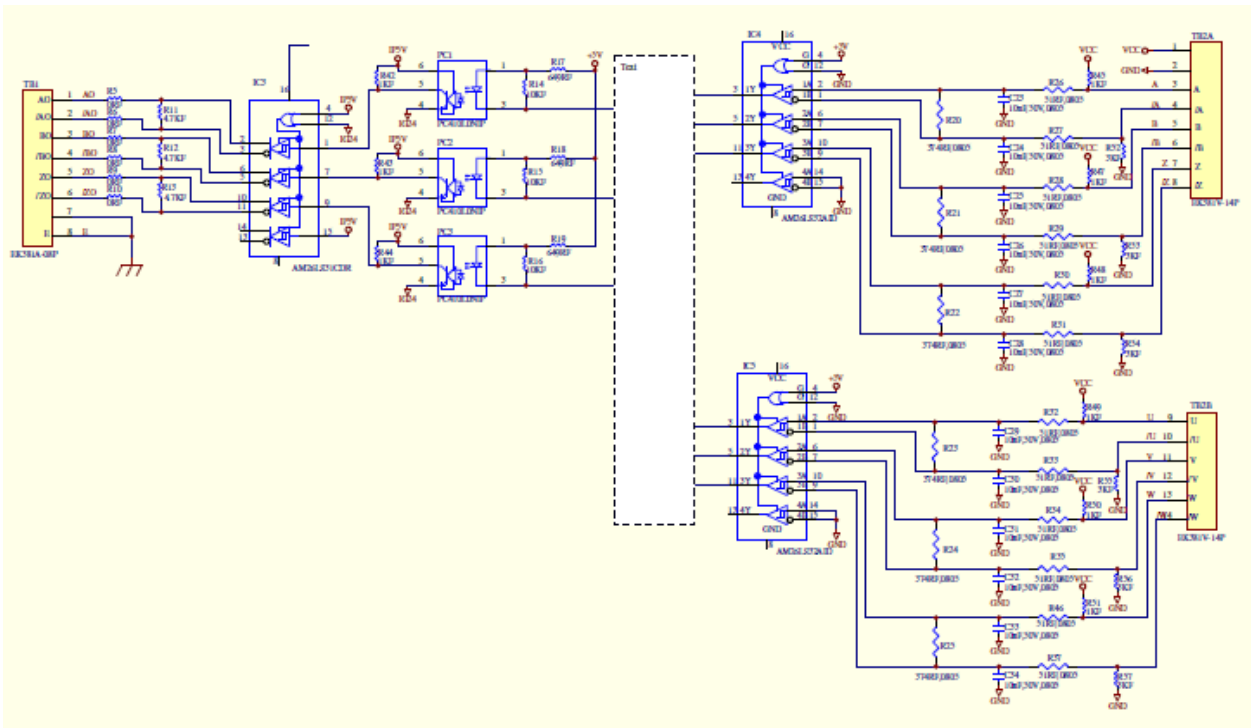

## D) JN5-PG-PMR speed feedback card with TAMAGAWA Resolver Encoder

### JN5-PG-PMR terminal specification

Terminal Name	Description
R+, R-	Excitation signal to Resolver. 7Vrms, 10KHz.
S1, S3	COS signals from Resolver.
S2, S4	SIN signals from Resolver.
a+, a-, b+, b-, z+, z-	A,B,Z pulse Monitor signal output, Line driver output Type,RS-422 level.
E	Grounding terminal

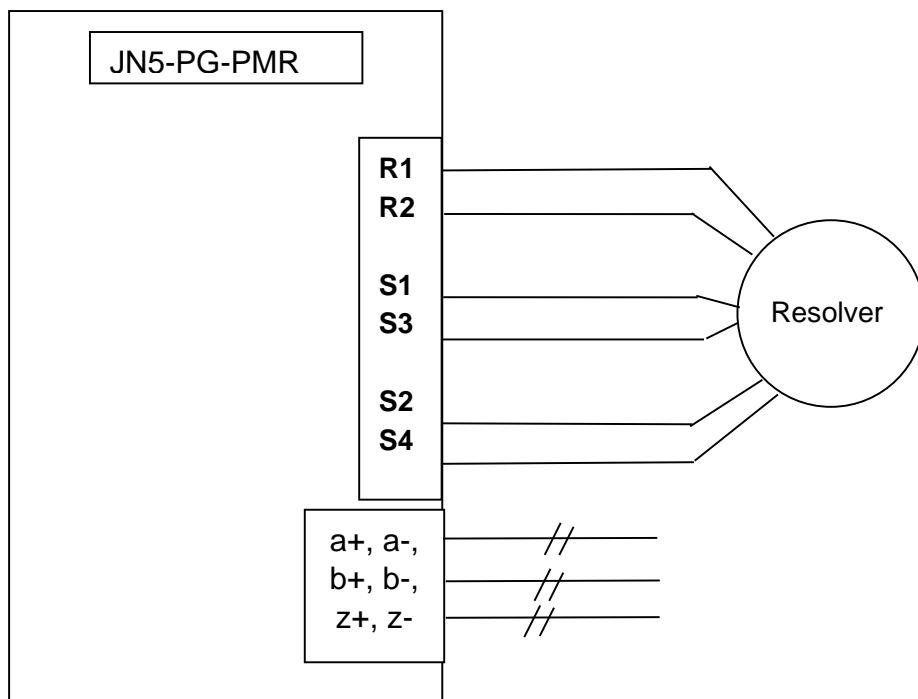

**E) JN5-PG-PMS/JN5-PG-PMS-24 speed feedback card with Heidenhain ERN 1387 Encoder**

**JN5-PG-PMS / JN5-PG-PMS-24 terminal specification**

Terminal Name	Description
<b>E5V</b>	Power supply for encoder. 5V±5%, 200mA
<b>GND</b>	0V Common Terminal
<b>C+, C-</b>	input C pulse from the encoder, $V_{p-p} = 0.6 \sim 1.2V$
<b>D+, D-</b>	input D pulse from the encoder, $V_{p-p} = 0.6 \sim 1.2V$
<b>A+, A-</b>	input A pulse from the encoder, $V_{p-p} = 0.6 \sim 1.2V$ , $f_{max} = 20KHz$
<b>B+, B-</b>	input B pulse from the encoder, $V_{p-p} = 0.6 \sim 1.2V$ , $f_{max} = 20KHz$
<b>R+, R-</b>	input R pulse (encoder home pulse)
<b>a+, a-</b>	output a ratio of the A pulse frequency
<b>b+, b-</b>	output b ratio of the B pulse frequency

Note: The a+, a-, b+, b- of JN5-PG-PMS-24 are open collector type output.

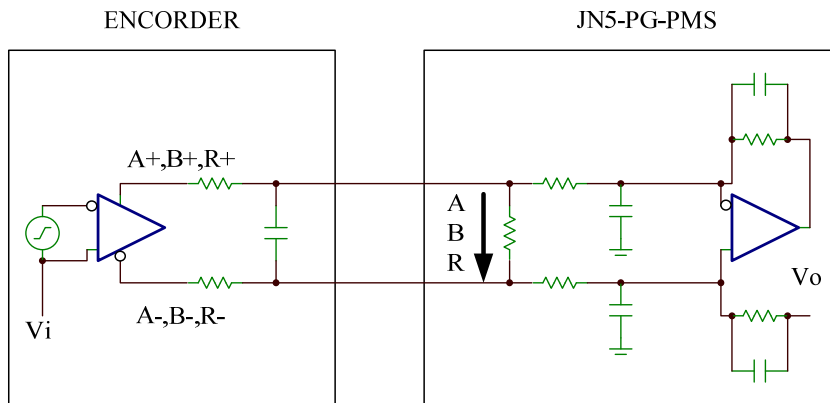

**F. JN5-PG-PMC/JN5-PG-PMC-24 speed feedback card with Heidenhain ECN 1313 Encoder**

**JN5-PG-PMC / JN5-PG-PMC-24 terminal specification**

Terminal Name	Description
<b>E5V</b>	Power supply for encoder. 5V±5%, 200mA
<b>GND</b>	0V Common Terminal
<b>DATA+/-</b>	Bi-direct data for the encoder, RS485 driver.
<b>CLOCK+/-</b>	output clock to the encoder, line driver RS422 output
<b>A+, A-</b>	input A pulse from the encoder, $V_{p-p} = 0.6 \sim 1.2V$ , $f_{max} = 20KHz$
<b>B+, B-</b>	input B pulse from the encoder, $V_{p-p} = 0.6 \sim 1.2V$ , $f_{max} = 20KHz$
<b>a+/a-, b+/b-</b>	line driver RS422 output( a ratio of the A,B pulse frequency)

Note: The a+, a-, b+, b- of JN5-PG-PMS-24 are open collector type output.

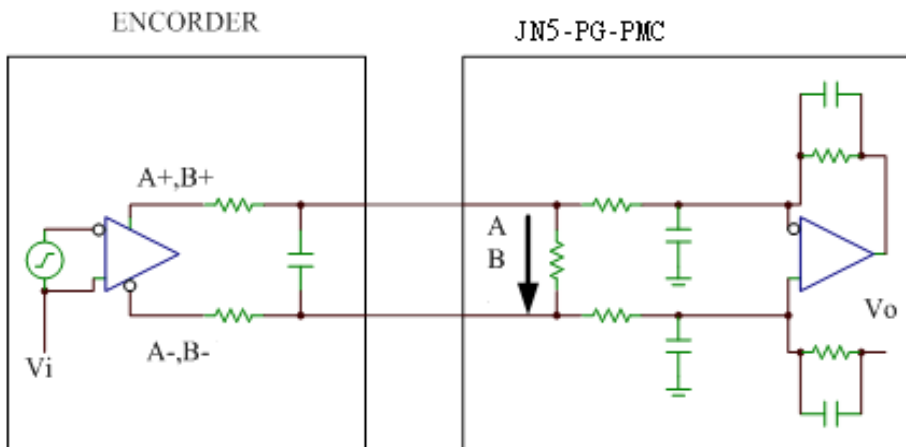

## 11.6 Other Options

### A. Blank cover and keypad extension cable

When used for remote control purposes, the keypad can be removed and remotely connected with an extension cable. Extension cables are available in the following lengths: 1m (3.3ft), 2m (6.6ft), 3m (10ft), and 5m (16.4ft).

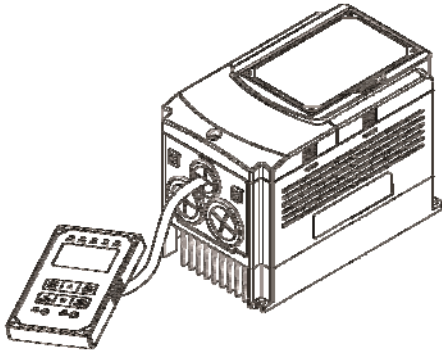

**Remote control**

Name	Model	Specification
LED digital operator wire with blank cover	JN5-CB-01MK	<b>1m (3.3ft)</b>
	JN5-CB-02MK	<b>2m (6.6ft)</b>
	JN5-CB-03MK	<b>3m (10ft)</b>
	JN5-CB-05MK	<b>5m (16.4ft)</b>

When using a remote mount keypad a blank cover can be installed in place of the original keypad to prevent dust and debris from entering the inverter.



**Blank keypad cover**

Name	Model	Specification
Blank cover	JN5-OP-A03	Blank cover

Name	Model	Specification
LED digital operator wire	JN5-CB-01M	<b>1m (3.3ft)</b>
	JN5-CB-02M	<b>2m (6.6ft)</b>
	JN5-CB-03M	<b>3m (10ft)</b>
	JN5-CB-05M	<b>5m (16.4ft)</b>

## LED/LCD keypad dimensions

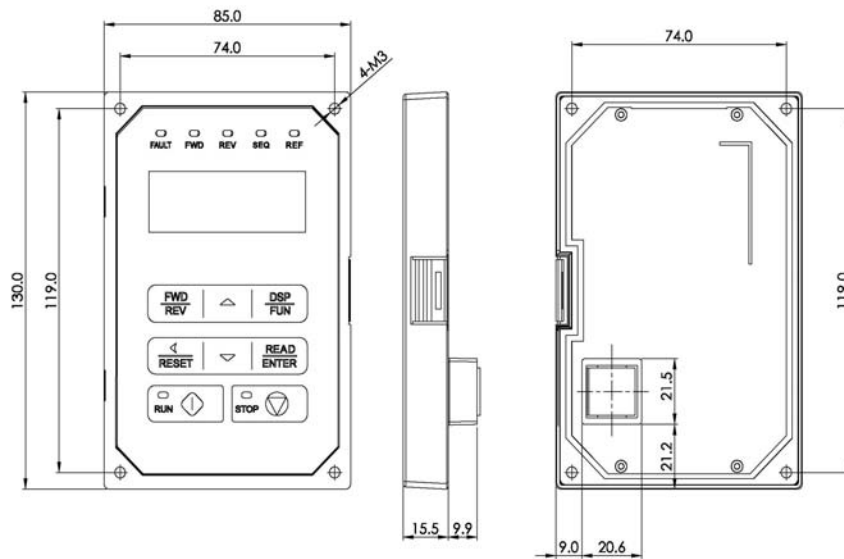

## B. Copy Unit (JN5-CU)

The copy unit is used to copy an inverter parameter setup to another inverter. The copy unit saves time in applications with multiple inverters requiring the same parameter setup.

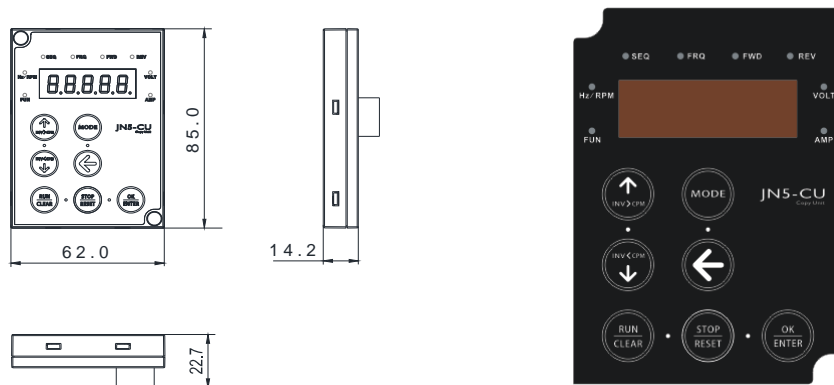

Copy Unit (JN5-CU) dimensions and appearance

## C. Option Protective Cover

The installation environment will have a direct affect on the correct operation and the life span of the inverter. To obtain maximum service life inverter shall be installed in a suitable environment as specified in this manual. Chapter 3.1.

Option cover may be used to provide protection against external objects entering the unit and restrict dust ingress. No temperature derate is necessary.

**Option cover part numbers:**

Frame	Model
1	JN5-CR-A01
2	JN5-CR-A02
4	JN5-CR-A04

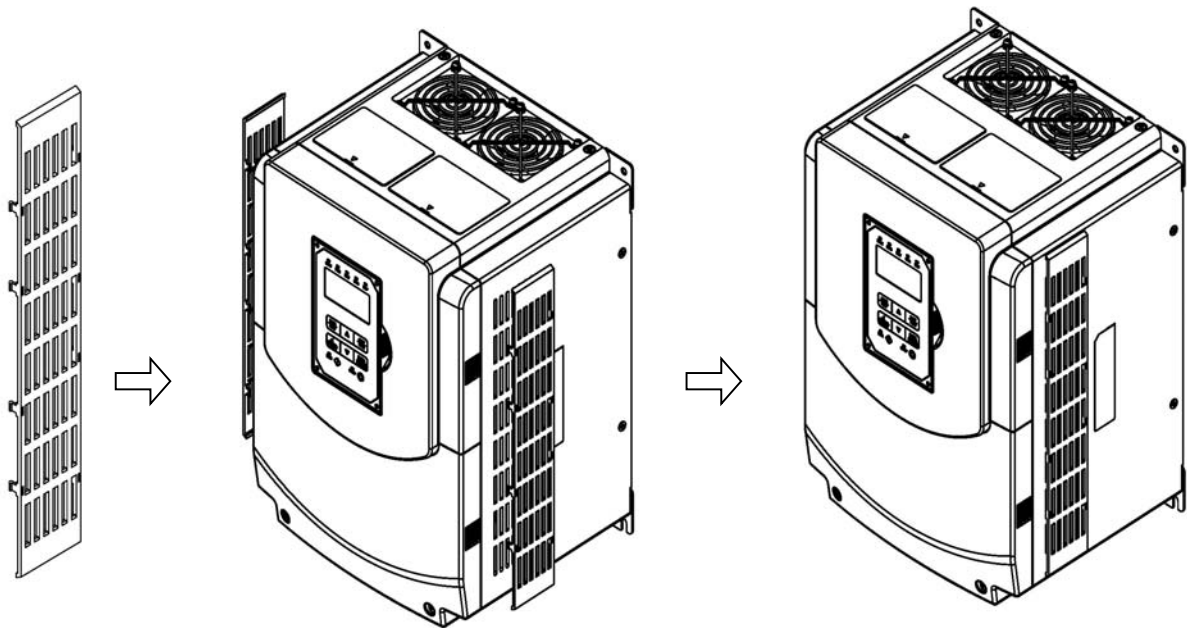

**Protective Cover**

**Installation of Protective Cover**

**Inverter with Protective Cover**

**D. High-speed communication expansion card & I/O expansion card & DC24V power card & Middle layer case**

If frame 1~4 of the enhanced inverter need to install encoder feedback card, high-speed communication expansion card, I/O expansion card or DC24V power card, middle layer case is necessary, which is option, to install between the top cover and the bottom case, for adding extra space to install the expansion card. For frame 2~4 of enhanced inverter, if only install encoder feedback card, middle layer case is not necessary to use.

Table 1. Expansion card model number

Expansion card type	Model number	Reference chapter
PROFIBUS high-speed comm.	JN5-CMHI-PDP	11.9
CANopen high-speed comm.	JN5-CMHI-CAN	11.10
EtherCAT high-speed comm.	JN5-CMHI-ECAT	11.11
I/O expansion	JN5-IO-2DO1AI	11.12
DC24V power card	JN5-PS-DC24V	11.15



Table 2. Middle layer case model number

Frame	Middle layer case model number	Note
1	JN5-MD-A01	After installation, the depth (D) increases by 44mm
2	JN5-MD-A02	After installation, the depth (D) increases by 31mm
3	JN5-MD-A03	After installation, the depth (D) increases by 34mm
4	JN5-MD-A04	After installation, the depth (D) increases by 35mm

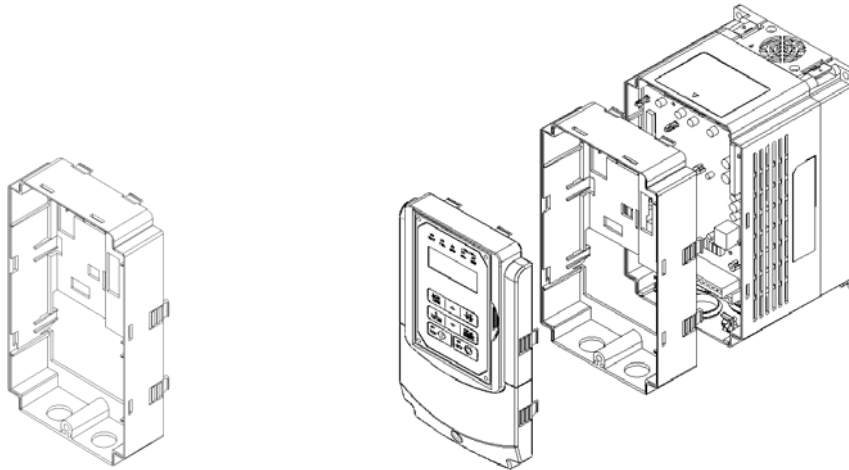

Middle layer case outline

Middle layer case installation diagram

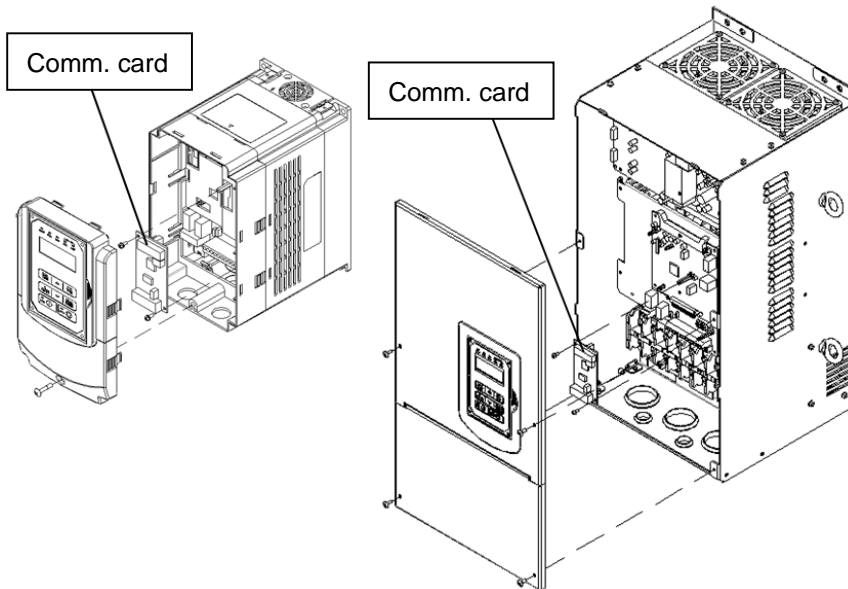

Communication card installation diagram

## 11.7 Communication Modules

**(a) PROFIBUS communication interface module (JN5-CM-PDP)**

For wiring example and communication setup refer to JN5-CM-PDP communication option manual.

**(b) DEVICENET communication interface module (JN5-CM-DNET)**

For wiring example and communication setup refer to JN5-CM-DNET communication option manual.

**(c) CANopen communication interface module (JN5-CM-CAN)**

For wiring example and communication setup refer to JN5-CM-CAN communication option manual.

**(d) TCP-IP communication interface module (JN5-CM-TCPIP)**

For wiring example and communication setup refer to JN5-CM-TCPIP communication option manual.

**(e) EtherNet/IP communication interface module (JN5-CM-EIP)**

For wiring example and communication setup refer to the contents of Chapter 11.17.

## 11.8 NEMA1 Kit

If NEMA1 or IP20 protective level is necessary to upgrade, it is recommended to purchase the NEMA1 kit positioned on top and bottom sides of the inverter. The drawings installed in the inverter, please refer to chapter 3.7.

Frame	Model
6	JN5-NK-A06
7	JN5-NK-A07
8	JN5-NK-A08

# 11.9 PROFIBUS high speed communication expansion card

## 11.9.1 Communication hardware and data structure

This product is the PROFIBUS high-speed communication expansion module; it can perform remote setting and communication functions through the PROFIBUS bus. It is used on the TECO A510s/F510 AC motor driver (hereinafter referred to as the “driver”), and allows the driver to operate on the PROFIBUS network.

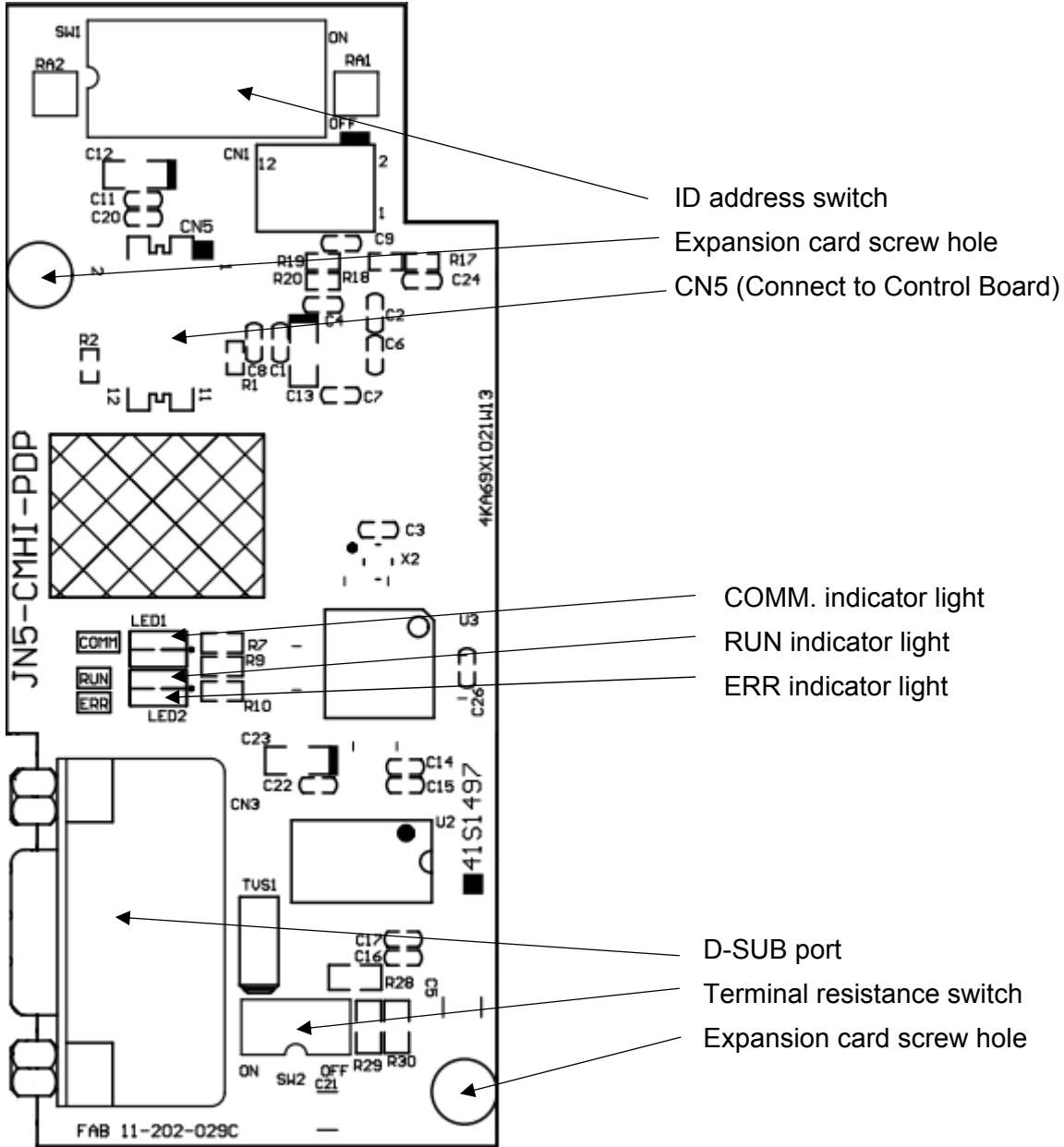

## 11.9.2 Product specifications

### PROFIBUS ports

Item	Specifications
Connector	DB-9
Transmission rate	9.6Kbit/s to 12Mbit/s (automatic detection of transmission rate)
Network protocols	PROFIBUS communication protocol

### AC motor driver port

Item	Specifications
Connector	Communication card CN5 connector
Transmission method	SPI high speed communication
Terminal functions	1. The communication module communicates with the AC motor driver through this interface. 2. The AC motor driver provides power to the communication module through this interface.
Communication protocols	TECO communication protocol

### 11.9.3 Installation instructions

#### PROFIBUS network connection

Definitions of PROFIBUS DP communication port pins are as shown in the figure below.

	Pin	Definition	Description
	1~2	Not assigned	-
	3	RXD/TXD-P (B-Line)	Receive/Send data -P
	4	Not assigned	-
	5	DGND (2M)	Data reference potential
	6~7	Not assigned	-
	8	RXD/TXD-N (A-Line)	Receive/Send data -N
	9	Not assigned	-

#### PROFIBUS network connection

As shown in the figure below, ID addresses (1~125) correspond to SW1 b1~b7.

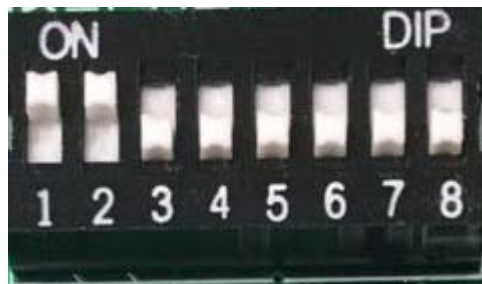

Function	DIP switch position	DIP switch status	Description
Network address setting	b1~b7	1000000	Network address is 1
		0100000	Network address is 2
		1100000	Network address is 3
		.....	.....
		1011111	Network address is 125
No function	b8	-	-

Network address switch setting range: 1~125 (0, 128~255 cannot be used).

# PROFIBUS bus terminal resistor

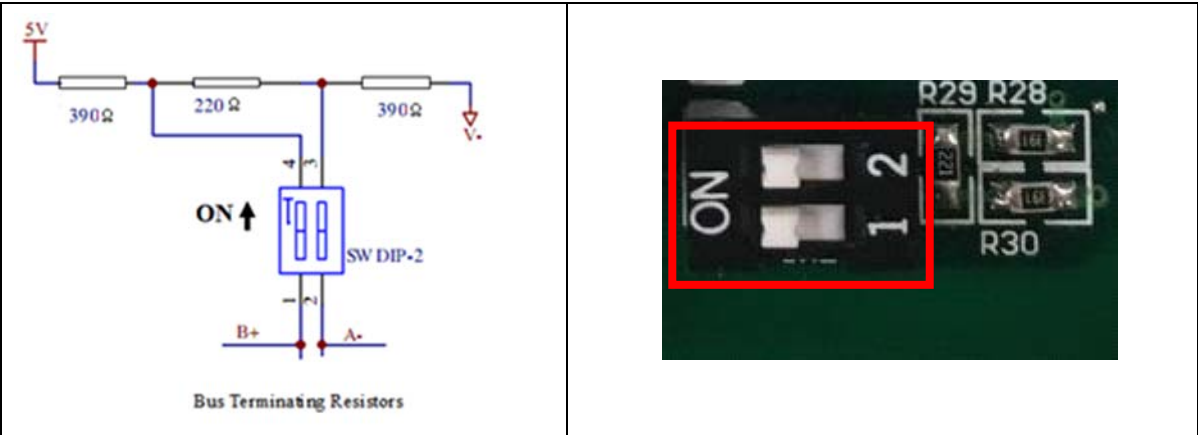

The first and last station of the PROFIBUS bus must be connected to the bus, and the bus terminal resistor must be turned on.

Serial transmission rate ( kbps )	Maximum bus length ( m )
9.6	1200
19.2	1200
45.45	1200
93.75	1200
187.5	1000
500	400
1500	200
3000	100
6000	100
12000	100

### 11.9.4 LED indicator descriptions

The module has two dual-color LED indicators built-in used to quickly diagnose and monitor the communication statuses between the module itself and the bus.

#### Module status LED (RUN LED & ERR LED)

Used to monitor whether the equipment is operating normally.

Indicator statuses	Description
Does not light up	Power not supplied
Orange light lights up	Communication with the frequency converter not established
Red light flashes (1 Hz)	Communication error with the frequency converter
Red light flashes (4 Hz)	Flip-switch ID address error
Green light flashes (4 Hz)	Power supply normal but DP communication not established
Green light lights up	DP communication normal

#### Network status LED (COMM LED)

Used to monitor the operability of the communication module PROFIBUS network.

Indicator statuses	Description
Does not light up	DP communication not established
Green light lights up	DP communication established and normal

### 11.9.5 Driver parameter setting descriptions

Used to monitor the operability of the communication module PROFIBUS network.

Users must first confirm related parameter settings on the driver in order to ensure that the communication module can connect normally.

Parameters	Parameter name	Settings	Settings descriptions
00-02	Operation command source	2	Communication control
00-05	Frequency command source	3	Communication control

### 11.9.6 Connection instructions

#### PPO communication

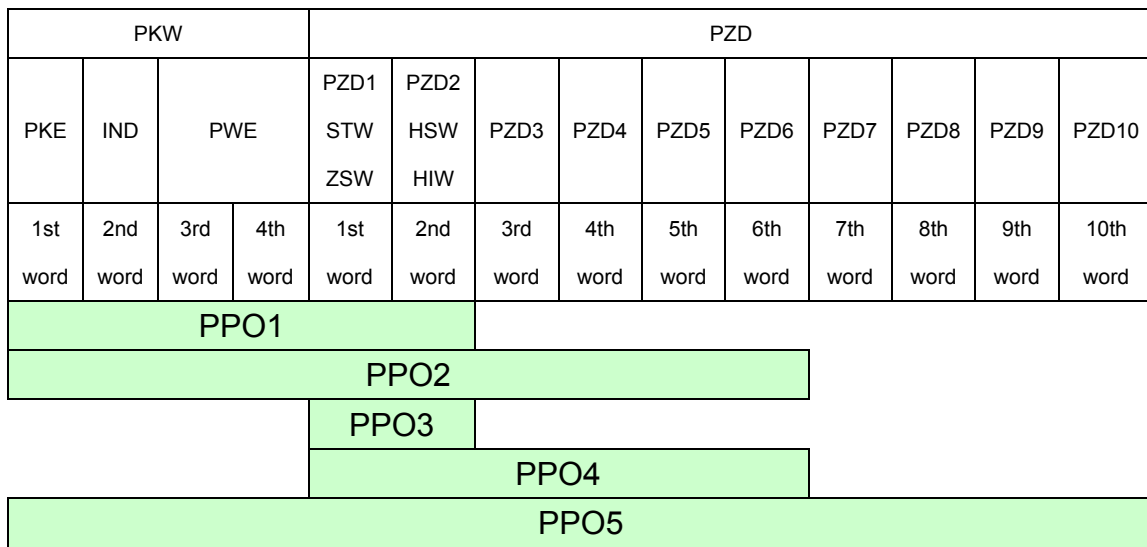

<b>PKW:</b> Parameter address/value	<b>STW:</b> Control character
<b>PZD:</b> Process data	<b>ZSW:</b> Status character
<b>PKE:</b> Parameter address	<b>HSW:</b> Main settings
<b>IND:</b> Subindex	<b>HIW:</b> Main actual value
<b>PWE:</b> Parameter value	

#### PZD Structure default

User parameters of the communication module configured through the GSD file. Default values of the PZD structure are as follows:

STW1 Control character; mapped to the MODBUS address 0x2501 of the driver.

HSW Main setting value; mapped to the MODBUS address 0x2502 of the driver.

ZSW1 Status character; mapped to the MODBUS address 0x2520 of the driver.

HIW Main actual value; mapped to the MODBUS address 0x2524 of the driver.

PLC Master station → driver slave station



PZD3/ PZD4: Not used.

Driver slave station → PLC master station

Driver output status; mapped to the MODBUS addresses 0x2520~0x252F of the driver.

The default values of PZD3/PZD4/PZD5/PZD6 are set as follows:

PZD3: Default multi-function terminal block on/off status; mapped to the MODBUS address 0x2522 of the driver.

PZD4: Default output current; mapped to the MODBUS address 0x2527 of the driver.

PZD5: Default output current; mapped to the MODBUS address 0x2521 of the driver.

PZD6: Default output current; mapped to the MODBUS address 0x2528 of the driver.

### 11.9.7 Meanings of each character

#### Control character STW

Bit	Description	1	0
0	Operation command	Operate	Stop
1	Reverse command	Reverse	Forward
2	External error	Error	-
3	Error reset	Reset	-
4~5	Reserved	-	-
6	Multi-function terminal S1	ON	OFF
7	Multi-function terminal S2	ON	OFF
8	Multi-function terminal S3	ON	OFF
9	Multi-function terminal S4	ON	OFF
A	Multi-function terminal S5	ON	OFF
B	Multi-function terminal S6	ON	OFF
C	Multi-function terminal S7	ON	OFF
D	Multi-function terminal S8	ON	OFF
E	Controller mode	ON	OFF
F	Communication setting torque command	ON	

#### Status character ZSW

Bit	Meaning	1	0
0	Operation status	Operate	Stop
1	Direction status	Reverse	Forward
2	Frequency converter operation preparation status	Preparation complete	Not yet prepared
3	Error	Abnormal	Normal
4	Warning	ON	OFF
5	Zero speed	ON	OFF

6	Model 440	ON	OFF
7	Frequency reached	ON	OFF
8	Any frequency reached	ON	OFF
9	Frequency detection one	ON	OFF
A	Frequency detection two	ON	OFF
B	Low voltage	ON	OFF
C	Frequency converter no output	ON	OFF
D	Frequency not according to communication	ON	OFF
E	SeqNotFromComm	ON	OFF
F	Over-torque	ON	OFF

### 11.9.8 PKW regional access parameters

The driver can provide request and response information. Due to the request and response mechanism, the master station must send requests until a communication response is received. The 4 characters of the PKW region are as follows:

Word 1	Parameter ID(PKE)		
bit	15	12	11 0
	AK		Parameter number(PNU)
Word 2	IND Reserved		
Word 3	PWE1		
bit	15	8	7 0
	Reserved		Fault number
Word 4	PWE2 Read/Write parameters		

#### Parameters address PKE

Bit 0~11 (PNU): Parameter address/MODBUS address that includes related parameters.

Parameter address/MODBUS address: Please refer to the MODBUS communication protocol description chapter in the driver manual for the register numbers, registers and data format that corresponds to the operation parameters.

Bit 12~15 (AK): Includes the identification characters of requests or responses.

## Request character AK

PLC master station → driver slave station

Request Identifier	Description
0	No request
1	Read parameter value
2	Modify parameter value

## Response character AK

Driver slave station → PLC master station

Request Identifier	Description
0	No response
1	Request parameter value processed
7	Request parameter value cannot process

## Error character

If the request parameter value was not processed, then the error codes that will be kept in the low-bit PWE1 set are as follows:

Error code	Description
0	Parameter does not exist
1	The current status parameter cannot be read/written
2	Parameter value not within range
101	Other SP communication error occurred, such as: response timeout

## Parameter Value PWE

Driver parameters are sent through PWE2 (4th word). In the following example, PWE1 (3rd word) must be set as 0 in the PROFIBUS master station.

### Example of the PKW mechanism:

For example: Read parameters 00-05 (frequency command source).

Read the values of 00-05; first set the request identification character as 1, and then refer to the MODBUS communication protocol description chapter in the driver manual to find out that the address of 00-05 is 0x0005, then the data sequences are as follows:

PLC master station → driver slave station: 1000 0005 0000 0000

Driver slave station → PLC master station: 1000 0005 0000 0004

Request	
1st word (PKE)	1000
2nd word (IND)	0005
3rd word (PWE1)	0000
4th word (PWE2)	0000

Response	
1st word (PKE)	1000
2nd word (IND)	0005
3rd word (PWE1)	0000
4th word (PWE2)	0004

### 11.9.9 Troubleshooting

There are two indicators on top of the PROFIBUS communication module; when malfunction occurs, the cause of the malfunction can be confirmed based on the indicator statuses, and troubleshoot the error by following the descriptions below.

#### Indicator troubleshooting

##### Module status LED

Indicator statuses	Status name	Troubleshooting method
Does not light up	Power not supplied to the communication module	<ol style="list-style-type: none"> <li>1. Confirm whether the driver power is normal.</li> <li>2. Confirm whether the power terminal of the communication module is connected to the driver.</li> </ol>
Red and green light flashes alternately	Self-check	<ol style="list-style-type: none"> <li>1. The host is under self-check; if it flashes continuously, disconnect the power and then reconnect it.</li> <li>2. Confirm whether the driver communication connection parameters are properly set (19200, 8, N, 1)</li> </ol>
Green light flashes	the communication module standby	<ol style="list-style-type: none"> <li>1. Not yet connected with the driver.</li> </ol>

##### Network status LED

Indicator statuses	Status name	Description
--------------------	-------------	-------------

Does not light up	Power not supplied	1. Confirm whether the driver power is normal. 2. Confirm whether the power terminal of the communication module is connected to the driver.
	Standby	1. Not yet connected with the PROFIBUS host terminal.

### 11.9.10 GSD File

When using the Profibus communication module, if the GSD description file (JN5-CMHI-PDP\_V (latest version).GSD) is needed, please download it from the TECO official website or request for it from your purchasing sales channel.

# 11.10 CANopen high speed communication expansion card

## 11.10.1 Communication hardware and data structure

This product is the CANopen high-speed communication expansion module; it can perform remote setting and communication functions through the CANopen bus. It can only be used with the TECO A510s/F510 AC motor driver (hereinafter referred to as the “driver”), and allow the driver to operate on the CANopen network.

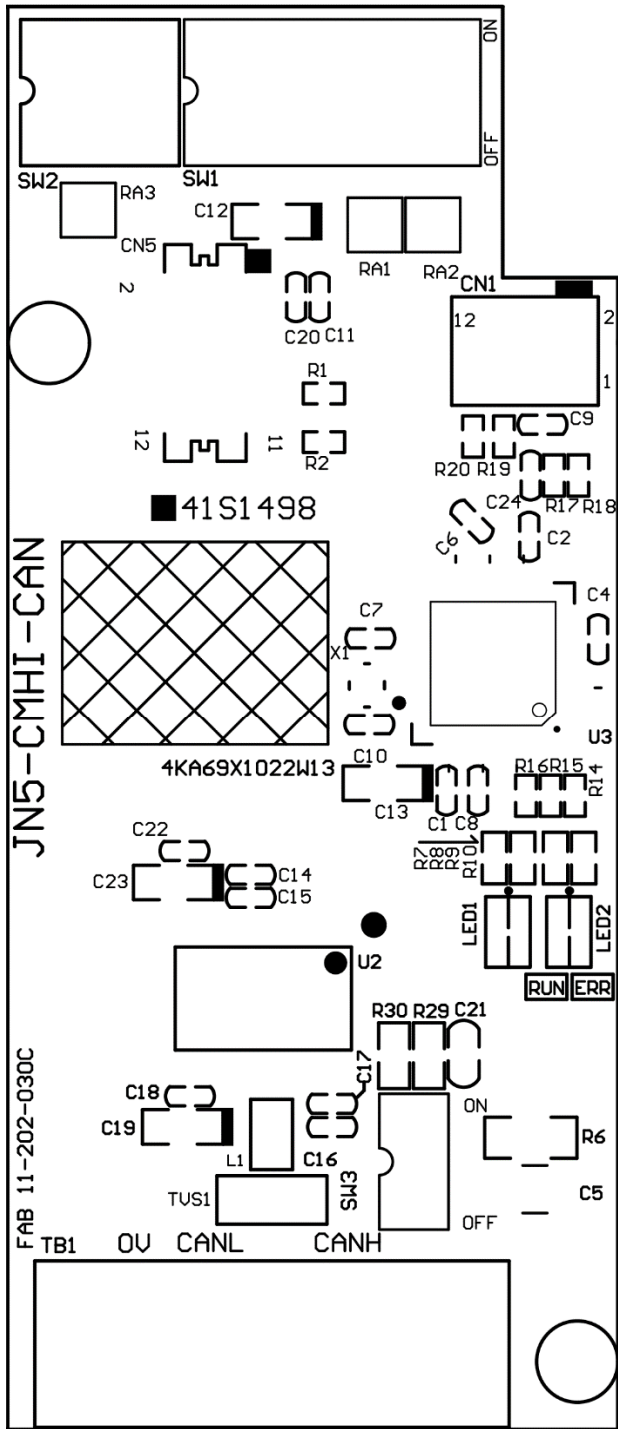

## 11.10.2 Product specifications

### CANopen ports

Item	Specifications
Connector	5-pin open pluggable connector; pin spacing 5.08mm
Transmission rate	10kbps, 20kbps, 50kbps, 125kbps, 250kbps, 500kbps, 800kbps, 1Mbps
Network protocols	CANopen communication protocol

### AC motor driver port

Item	Specifications
Connector	Communication card CN5 connector
Transmission method	SPI high speed communication
Terminal functions	1. The communication module communicates with the AC motor driver through this interface. 2. The AC motor driver provides power to the communication module through this interface.
Communication protocols	TECO communication protocol

### 11.10.3 Installation instructions

#### Communication module contact description

As shown in the figure below, A – Terminal block (TB1)

B, C – Mounting holes

D - RUN LED

E - ERR LED

F – Control board connector (CN5)

G - Rate setting switch

H – ID address setting switch

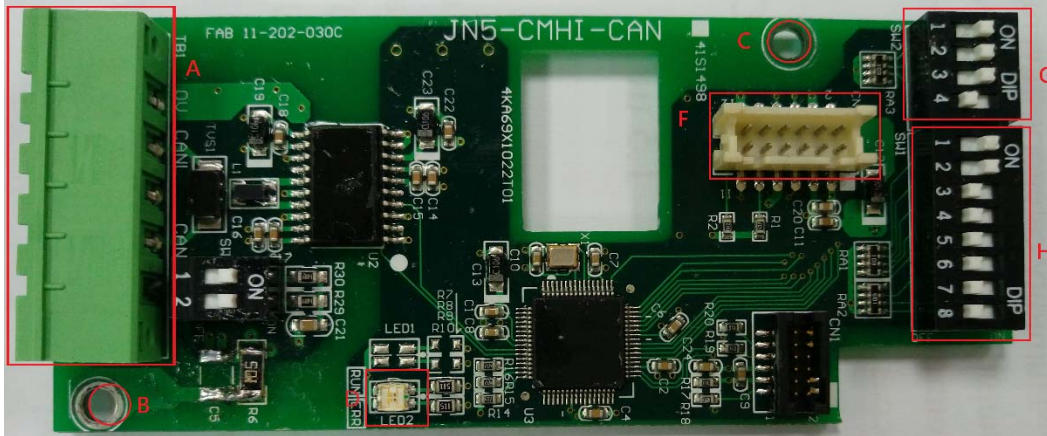

#### Terminal block definition

As shown in the figure below, the contact definitions in the order from left to right are GND, CAN\_L, NC, CAN\_H and NC.

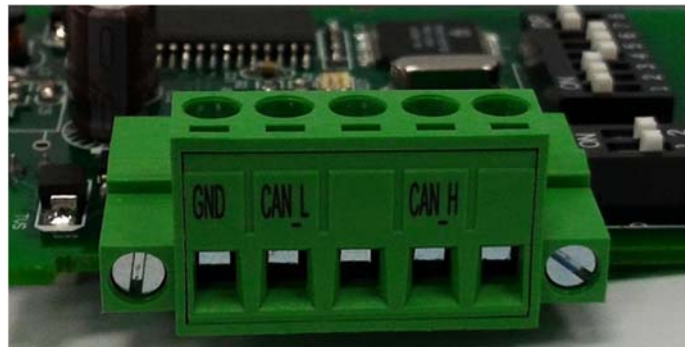



## ID address setting description

As shown in the figure below, ID addresses (1~127) correspond to SW1 b1~b7.

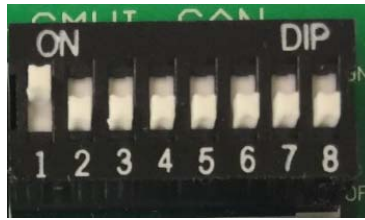

Transmission rate corresponds to SW2 b1~b3.

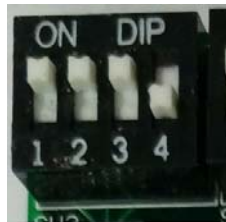

Function	DIP switch position	DIP switch status 7654321	Description
Network address Setting	SW1 b7—b1	0000000	Cannot be used
		0000001	Network address is 1
		0000010	Network address is 2
		0000011	Network address is 3
		.....	.....
		1111110	Network address is 126
		1111111	Network address is 127
CANopen Transmission rate setting	SW2 b3—b1	000	10K
		001	20K
		010	50K
		011	125K
		100	250K
		101	500K
		110	800K
		111	1M

Network address switch setting range: 1~127 (0, 128~255 cannot be used).

Transmission rate switch setting range: 0~7 (8~15 cannot be used).

## 11.10.4 Transmission rate, maximum transmission distance and cable length

The maximum allowable length of the bus bar mainly depends on the type of cable used. The allowed cable types are:

- Thin cable
- Thick cable
- Flat cable

ODVA requirements for data transmission cable (Thick cable):

Serial transmission rate ( kbps )	Maximum bus length ( m )	Serial transmission rate ( kbps )	Maximum bus length ( m )
1000	25	125	500
800	50	50	1000
500	100	20	2500
250	250	10	5000

## 11.10.5 LED indicator descriptions

The module has RUN (green) and ERR (red) indicators built-in used to quickly diagnose and monitor the communication statuses between the module itself and the bus.

### Module status LED (RUN LED)

Used to monitor whether the equipment is operating normally.

Indicator statuses	Status name	Description
Does not light up	Initial status	Power not supplied
Continuous flashing	Pre-operation	Preparation status
Single flash	Stop	Stopping
Green light lights up	Operation	Operating

### Error status LED (ERR LED)

Used to monitor the operability of the communication module CANopen network.

Indicator statuses	Status name	Description
Does not light up	No error	Operating

Single flash	Warning	Packet error
Double flash	Error	Guard/Heartbeat error
Red light lights up	Disconnected	Bus closed

### 11.10.6 Driver parameter setting descriptions

Used to monitor the operability of the communication module CANopen network.

Users must first confirm related parameter settings on the driver in order to ensure that the communication module can connect normally.

Parameters	Parameter name	Settings	Settings descriptions
00-02	Operation command source	2	Communication control
00-05	Frequency command source	3	Communication control

### 11.10.7 Connection instructions

#### Service data object (SDO)

This module supports 1 SDO server, which means it can provide SDO service, and the SDO uses the sending and receiving COB-ID of the predefined connection, 0x580 + NodeID (sending) and 0x600 + NodeID (receiving).

Each SDO message includes a set of COB-ID (request SDO and response SDO); it allows performing of access actions within two nodes. SDO can transmit any size of data, but segment transmission must be used once it exceeds 4 bytes.

The COB IDs of SDO communication are as follows:

Read: Master to slave (request code 0x40) / Master to slave: 600H + Node ID

COB-ID	Byte0	Byte1	Byte2	Byte3	Byte4	Byte5	Byte6	Byte7
(600H) + Node ID	Request code	Object index		Object subindex	Request data			
		LSB	MSB		Reserved			

Read: Slave response / slave to master: 580H + Node ID

COB-ID	Byte0	Byte1	Byte2	Byte3	Byte4	Byte5	Byte6	Byte7
(580H) + Node ID	Request code	Object index		Object subindex	Request data			
		LSB	MSB		bit0~bit7	Bit8~bit15	Bit16~bit23	Bit24~bit31

Response code:

43H: Read 4-byte data / 4BH: read 2-byte data / 4FH: read 1-byte data

Write: Master to slave (4-byte data maximum)

COB-ID	Byte0	Byte1	Byte2	Byte3	Byte4	Byte5	Byte6	Byte7
(600H) + Node ID	Request code	Object index		Object subindex	Request data			
		LSB	MSB		bit0~bit7	Bit8~bit15	Bit16~bit23	Bit24~bit31

Request code:

23H: Write a 4-byte data entry

2BH: Write a 2-byte data entry

2FH: Write a 1-byte data entry

Write: Slave to master (response code 0x60H)

COB-ID	Byte0	Byte1	Byte2	Byte3	Byte4	Byte5	Byte6	Byte7
(580H) + Node ID	Request code	Object index		Object subindex	Request data			
		LSB	MSB		Reserved			

When we use SDO to perform control to the group 25H of the driver control group, corresponding rules are as follows:

Index
25xxH (register address)

For example, when we want to perform write/read to 2501H of the control group, the corresponding SDO object index is the control group register address 2501H.

Perform operation with index 2501H directly and the module will automatically convert to the A510s 2501H control group register address to perform operation.

## 11.10.8 Object index list

### Basic index

Index	Sub	Name	Default value	R/W	Size	Remarks
1000H	0	Device type	00010192H	R	U32	
1001H	0	Error register	0	R	U8	
1005H	0	COB-ID SYNC message	80H	R	U32	
1006H	0	Communication cycle period	0	RW	U32	
1008H	0	Manufacturer device name	A510	R	U32	
1009H	0	Manufacturer hardware version	1.0	R	U32	
100AH	0	Manufacturer software version	1.00	R	U32	
1014H	0	COB-ID emergency	00000080H+Node-ID	R	U32	
1015H	0	Inhibit time EMCY	0	RW	U16	
1016H	0	number of entries	1	R	U8	
	1	Consumer heartbeat time	0	RW	U32	Not supported
1017H	0	Producer heartbeat time	0	RW	U16	
1018H	0	number of entries	3	R	U8	
	1	Vender ID	00000373H	R	U32	
	2	Product code	00000100H	R	U32	
	3	Revision	00010000H	R	U32	
1200H	0	Server SDO Parameter	2	R	U8	
	1	COB-ID Client Server	0000600H+Node-ID	R	U32	
	2	COB-ID Client Server	0000580H+Node-ID	R	U32	
1400H	0	Number of entries	2	R	U8	
	1	COB-ID used by PDO	00000200H+Node-ID	RW	U32	
	2	Transmission Type	0xFF	RW	U8	
1401H	0	Number of entries	2	R	U8	
	1	COB-ID used by PDO	00000300H+Node-ID	RW	U32	
	2	Transmission Type	0xFF	RW	U8	
1600H	0	Number of entries	2	RW	U8	
	1	1.Mapped Object	60400010H	RW	U32	
	2	2.Mapped Object	60420010H	RW	U32	
	3	3.Mapped Object	0	RW	U32	
	4	4.Mapped Object	0	RW	U32	

Index	Sub	Name	Default value	R/W	Size	Remarks
1601H	0	Number of entries	2	RW	U8	
	1	1.Mapped Object	604F0010H	RW	U32	
	2	2.Mapped Object	60500010H	RW	U32	
	3	3.Mapped Object	0	RW	U32	
	4	4.Mapped Object	0	RW	U32	
1800H	0	Number of entries	5	R	U8	Number of entries
	1	COB-ID used by PDO	180H+Node-ID	RW	U32	
	2	Transmission Type	0xFF	RW	U8	Transmission type
	3	Inhibit time	0x64	RW	U16	Inhibit time
	4	CMS-Priority Group	0	RW	U8	
	5	Event timer	0x64	RW	U16	Event timer
1801H	0	Number of entries	5	R	U8	Number of entries
	1	COB-ID used by PDO	00000280H+Node-ID	RW	U32	
	2	Transmission Type	0xFF	RW	U8	
	3	Inhibit time	0x64	RW	U16	Inhibit time
	4	CMS-Priority Group	0	RW	U8	
	5	Event timer	0x64	RW	U16	Event time
	4	CMS-Priority Group	0	RW	U8	
	5	Event timer	0x64	RW	U16	Event time
	2	Transmission Type	0xFF	RW	U8	
	3	Inhibit time	0x64	RW	U16	Inhibit time
	4	CMS-Priority Group	0	RW	U8	
	5	Event timer	0x64	RW	U16	Event time
	1A00H	0	Number of entries	2	RW	U8
1		1.Mapped Object	60400010	RW	U32	
2		2.Mapped Object	60420010	RW	U32	
3		3.Mapped Object	0	RW	U32	
4		4.Mapped Object	0	RW	U32	
1A01H	0	Number of entries	2	RW	U8	
	1	1.Mapped Object	604F0010	RW	U32	
	2	2.Mapped Object	60500010	RW	U32	
	3	3.Mapped Object	0	RW	U32	
	4	4.Mapped Object	0	RW	U32	

## DS402 part

Index	Sub-Index	Name	Default value	R/W	Size	Unit	PDO MAP
603F	0	Error code	0	RO	U16		Yes
6040	0	Control word	0	RW	U16		Yes
6041	0	Status word	0	RO	U16		Yes
6042	0	vl target velocity	0	RW	S16	Hz	Yes
6043	0	vl velocity demand	0	RO	S16	Hz	Yes
604F	0	vl ramp function time Acceleration time	100	RW	U16	0.1S	Yes
6050	0	vl slow down time Deceleration time	100	RW	U16	0.1S	Yes

## Driver control group command index

Command DATA (allows reading and writing)

Register address	Bit	Content
2500H	Reserved	
2501H	0	Operation command      1: Operate    0: Stop
	1	Reverse command      1: Reverse    0: Forward
	2	External error      1: Error
	3	Error reset      1: Reset
	4	Reserved
	5	Reserved
	6	Multi-function terminal S1    1: "ON"
	7	Multi-function terminal S2    1: "ON"
	8	Multi-function terminal S3    1: "ON"
	9	Multi-function terminal S4    1: "ON"
	A	Multi-function terminal S5    1: "ON"
	B	Multi-function terminal S6    1: "ON"
	C	Multi-function terminal S7    1: "ON"
	D	Multi-function terminal S8    1: "ON"
	E	Controller mode      1: "ON"
F	Communication setting torque command    1: "ON"	
2502H	*Frequency command (Unit: 0.01Hz)	
2505H	AO1 (0.00V ~ 10.00V)	
2510H	G12-00 H-WORD	
2511H	G12-00 L-WORD	

Monitor DATA (read only)

Register address		Bit	Content	
2520H	Status signal	0	Operation status	1: Operate 0: Stop
		1	Direction status	1: Reverse 0: Forward
		2	Frequency converter operation preparation status	1: Preparation complete 0: Preparation not yet complete
		3	Error	1: Abnormal
		4	Warning	1: "ON"
		5	Zero speed	1: "ON"
		6	Model 440	1: "ON"
		7	Frequency reached	1: "ON"
		8	Any frequency reached	1: "ON"
		9	Frequency detection one	1: "ON"
		A	Frequency detection two	1: "ON"
		B	Low voltage	1: "ON"
		C	Frequency converter no output	1: "ON"
		D	Frequency not according to communication	1: "ON"
		E	Operation not according to communication	1: "ON"
		F	Over-torque	1: "ON"
2521H	Error description	0	Reserved	31 Reserved
		1	UV (Under-voltage)	32 Reserved
		2	OC (Over-current)	33 Reserved
		3	OV (Over-voltage)	34 Reserved
		4	OH1 (Heat sink overheat)	35 Reserved
		5	OL1 (Motor overload)	36 Reserved
		6	OL2 (Frequency converter overload)	37 Reserved
		7	OT (Over-torque)	38 CF07 (Motor control fault)
		8	UT (Under-torque)	39 Reserved
		9	SC (Short circuit)	40 Reserved
		10	GF (Ground fault)	41 Reserved
		11	FO	42 Reserved
		12	IPL (Input phase loss)	43 Reserved
		13	OPL (Output phase loss)	44 Reserved
		14	OS	45 Reserved
		15	PGO	46 OH4 (Motor overheat)



Register address		Bit	Content						
		16	DEV		47	Reserved			
		17	EF1		48	Reserved			
		18	EF2		49	MtrSw (DI Motor Switch Fault)			
		19	EF3		50	OCA (Acceleration over-current)			
		20	EF4		51	OCD (Deceleration over-current)			
		21	EF5		52	OCC (Operation over-current)			
		22	EF6		53	CF08			
		23	EF7		54	PTCLS			
		24	EF8		55	PF (Protection fault)			
		25	FB (PID feedback signal error)		56	TOL			
		26	OPR(Keypad Removed)		57	STO2 (Safety switch 2)			
		27	Reserved		58	Reserved			
		28	CE		59	Reserved			
		29	STO (Safety switch 1)		60	Reserved			
		30	Reserved		61	Reserved			
2522H	DI status	0	Multi-function terminal S1		4	Multi-function terminal S5		8~F	Reserved
		1	Multi-function terminal S2		5	Multi-function terminal S6			
		2	Multi-function terminal S3		6	Multi-function terminal S7			
		3	Multi-function terminal S4		7	Multi-function terminal S8			
2523H		Frequency command (0.01Hz)							
2524H		Output frequency (0.01Hz)							
2526H		DC voltage command (0.1V)							
2527H		Output current (0.1A)							
2528H	Warning description	0	No alarm		30	RDE		60	Reserved
		1	OV		31	WRE		61	RETRY
		2	UV		32	FB		62	SE07
		3	OL2		33	VRYE		63	Reserved
		4	OH2		34	SE01		64	Reserved
		5	Reserved		35	SE02		65	OH1
		6	OT		36	SE03		66	FIRE
		7	Reserved		37	Reserved		67	ES

Register address	Bit	Content				
	8	Reserved	38	SE05	68	STP1
	9	UT	39	HPERR	69	BDERR
	10	OS	40	EF	70	EPERR
	11	PGO	41	Reserved	71	Reserved
	12	DEV	42	Reserved	72	Reserved
	13	CE	43	RDP	73	STP0
	14	CALL	44	Reserved	74	Reserved
	15	Reserved	45	OL1	75	STP2
	16	EF0	46	Reserved	76	RUNER
	17	EF1	47	Reserved	77	LOC
	18	EF2	48	Reserved	78	PTCLS
	19	EF3	49	BB1	79	Sys Init
	20	EF4	50	BB2	80	FBLSS
	21	EF5	51	BB3		
	22	EF6	52	BB4		
	23	EF7	53	BB5		
	24	EF8	54	BB6		
	25	Reserved	55	BB7		
	26	Reserved	56	BB8		
	27	Reserved	57	Reserved		
	28	Reserved	58	Reserved		
	29	Reserved	59	Reserved		
2529H		DO status				
252AH		AO1				
252BH		AO2				
252CH		AI 1 input (0.1%)				
252DH		AI 2 input (0.1%)				
252FH		L510(s)/ E510(s)/ A510(s)/ F510 Check				

### 11.10.9 Troubleshooting

There are two indicators on top of the CANopen communication module; when malfunction occurs, the cause of the malfunction can be confirmed based on the indicator statuses, and troubleshoot the error by following the descriptions below.

## Indicator troubleshooting

### Module status LED (RUN LED)

Indicator statuses	Status name	Troubleshooting method
Does not light up	Power not supplied to the communication module	1. Confirm whether the driver power is normal. 2. Confirm whether the power terminal of the communication module is connected to the driver.

### Error status LED (ERR LED)

Indicator statuses	Status name	Description
Single flash	CANopen packet error	Poor connection quality with the CANopen host terminal or host not connected when powered on. Continue transmission or power off inspection can be selected. Two results can be expected with continue transmission 1) Packet transmission returns to normal and the red light no longer flashes 2) Packet continues to have errors causing disconnection. When the power is off, check whether the TB1 terminal and cable are firmly connected, and whether the transmission rate, maximum transmission distance and cable length comply with ODVA specifications.
Double flash	Guard/Heartbeat error	User sends periodic heartbeat messages. If a message is not received after a specific time, please disconnect the power and check the connection status of that node.
Red light lights up	Disconnected	Cannot connect with the CANopen host terminal; disconnect the power and check whether the TB1 terminal and cable is firmly connected, and whether the transmission rate, maximum transmission distance and cable length comply with ODVA specifications.

### 11.10.10 EDS file

When using the CANopen communication module, if the EDS description file (JN5-CMHI-CAN\_V (latest version).eds) is needed, please download it from the TECO official website or request for it from your purchasing sales channel.

# 11.11 Introduction to the EtherCAT high speed communication expansion module

## 11.11.1 Communication hardware and data structure

This product is the EtherCAT high-speed communication expansion module (hereinafter referred to as communication module); it can perform remote setting and communication functions through the EtherCAT network environment. It can only be used with the TECO A510s/F510 AC motor driver (hereinafter referred to as a driver), and allow the driver to operate on the EtherCAT network.

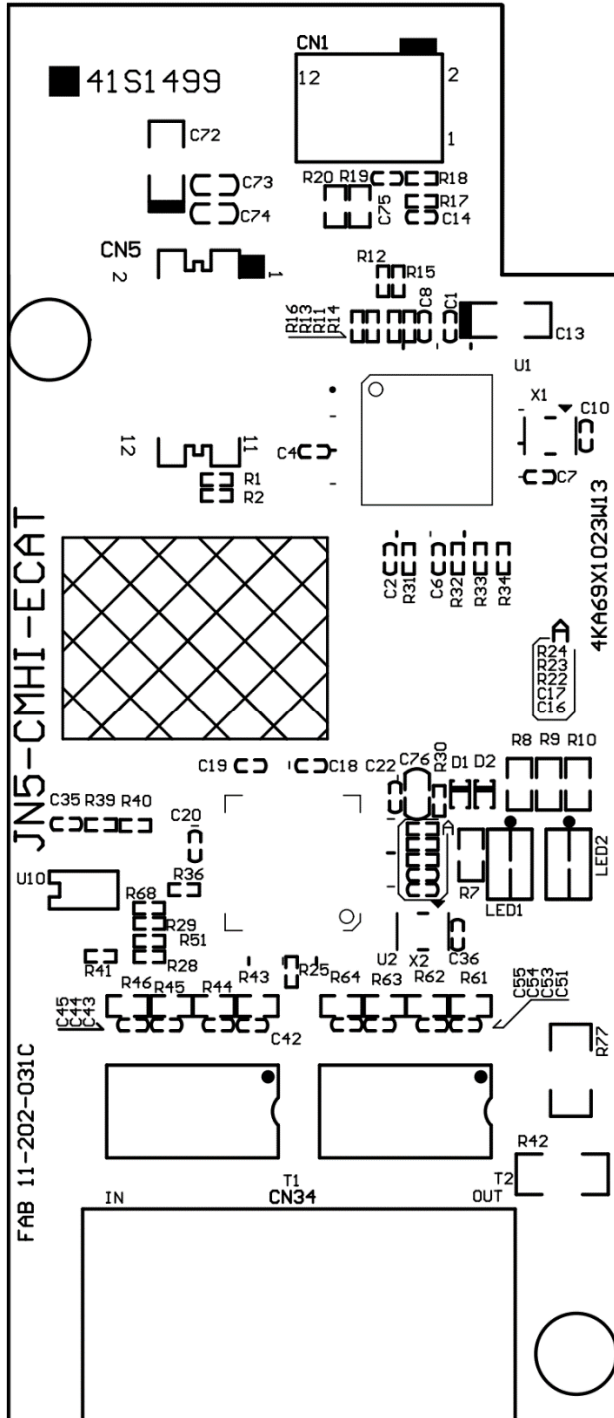

## 11.11.2 Product specifications

### EtherCAT ports

Item	Specifications
Connector	Dual-port network socket
Network protocols	EtherCAT communication protocol

### AC motor driver port

Item	Specifications
Connector	Communication card CN5 connector
Terminal functions	<ol style="list-style-type: none"> <li>1. The communication module communicates with the AC motor driver through this interface.</li> <li>2. The AC motor driver provides power to the communication module through this interface.</li> </ol>

## 11.11.3 Installation instructions

### Communication module contact description

As shown in the figure below, the framed part is the CN5 connector that connects to the driver.

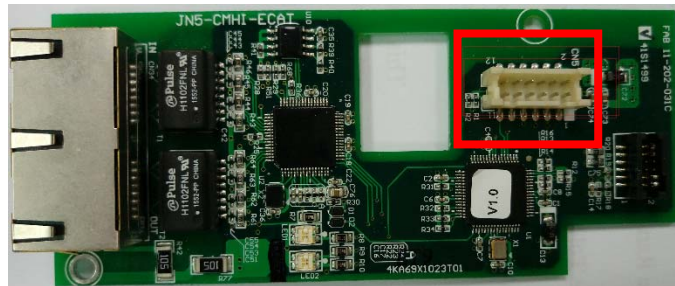

### Communication module network socket

As shown in the figure below, the left socket is input and the right socket is output.

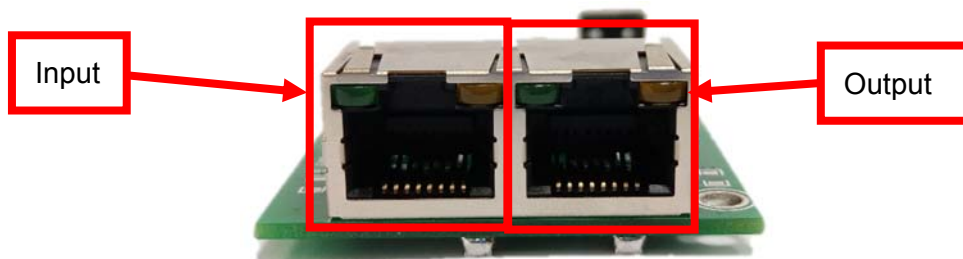

## Driver parameter setting description

Users must first confirm related parameter settings on the driver in order to ensure that the communication module can connect normally.

Parameters	Parameter name	Settings	Settings descriptions
00-02	Operation command source	2	Communication control
00-05	Frequency command source	3	Communication control

### 11.11.4 LED indicator descriptions

The module has two dual-color LED indicators built-in used to quickly diagnose and monitor the communication statuses between the module itself and the EtherCAT network.

#### Module status LED2

Used to monitor whether the communication module is operating normally.

Indicator statuses	Status name	Description
Does not light up	Power not supplied	Power not supplied
Red light flashes	Data transmitting	Driver and communication expansion module data transmitting
Red/green light lights up	Driver data transmission error	Data transmission error between the driver and communication expansion module

#### Network status LED1

Used to monitor the operability of the communication module EtherCAT network.

Indicator statuses	Status name	Description
Does not light up	Not connected / INIT	EtherCAT network not connected (INIT)
Green light flashes	Standby	Preparation status (Pre-OP)
Green light lights up	Operation status	Operation status (OP)
Red light lights up	Driver data transmission error	Data transmission error between the driver and communication expansion module

## 11.11.5 Object index list

### Basic index

Index	Sub-Index	Name	Default value	R/W	Size	Remarks
1000H	0	Device type	00000192H	R	U32	
1001H	0	Error register	0	R	U8	
1008H	0	Manufacturer device name	JN5-CM-CAN	R	U32	
1009H	0	Manufacturer hardware version	Version	R	U32	
100AH	0	Manufacturer software version	Version	R	U32	
1018H	0	number of entries	4	R	U8	
	1	Vender ID	0000081BH	R	U32	
	2	Product code	00000001H	R	U32	
	3	Revision	00000001H	R	U32	
1600H	0	Number of entries	2	RW	U8	
	1	1.Mapped Object	60400010H	RW	U32	
	2	2.Mapped Object	60420010H	RW	U32	
	3	3.Mapped Object	0	RW	U32	
	4	4.Mapped Object	0	RW	U32	
1601H	0	Number of entries	2	RW	U8	
	1	1.Mapped Object	604F0010H	RW	U32	
	2	2.Mapped Object	60500010H	RW	U32	
	3	3.Mapped Object	0	RW	U32	
	4	4.Mapped Object	0	RW	U32	
1A00H	0	Number of entries	3	RW	U8	
	1	1.Mapped Object	60400010	RW	U32	
	2	2.Mapped Object	60420010	RW	U32	
	3	3.Mapped Object	604F0020	RW	U32	
	4	4.Mapped Object	0	RW	U32	
1A01H	0	Number of entries	3	RW	U8	
	1	1.Mapped Object	604F0020	RW	U32	
	2	2.Mapped Object	60500020	RW	U32	
	3	3.Mapped Object	0	RW	U32	
	4	4.Mapped Object	0	RW	U32	

## Object part

Index	Sub-Index	Name	Default value	R/W	Size	Unit	PDO MAP
603F	0	Error code	0	RO	U16		Yes
6040	0	Control word	0	RW	U16		Yes
6041	0	Status word	0	RO	U16		Yes
6042	0	vl target velocity	0	RW	S16	Hz	Yes
6043	0	vl velocity demand	0	RO	S16	Hz	Yes
604F	0	vl ramp function time Acceleration time	Driver default value	RW	U32	0.1S	Yes
6050	0	vl slow down time Deceleration time	Driver default value	RW	U32	0.1S	Yes



### 11.11.6 Troubleshooting

There are two indicators on top of the EtherCAT communication module. When a malfunction occurs, the cause of the malfunction can be confirmed based on the indicator statuses, and troubleshoot the error by following the descriptions below.

#### Indicator troubleshooting

##### Module status LED2

Indicator statuses	Status name	Troubleshooting method
Does not light up	Power not supplied	1. Confirm whether the driver power is normal. 2. Confirm whether the power terminal of the communication module is connected to the driver.
Red/green light lights up	Driver data transmission error	1. Confirm whether the communication module has proper contact. 2. Reconnect the power of the driver and confirm whether the error has been eliminated.

##### Network status LED1

Indicator statuses	Status name	Description
Does not light up	Not connected / INIT	1. Confirm whether the driver power is normal. 2. If connected to EtherCAT, confirm whether it is in INIT mode.
Red light lights up	Driver data transmission error	1. Confirm whether the communication module has proper contact. 2. Reconnect the power of the driver and confirm whether the error has been eliminated.

### 11.11.7 xml file

When using the EtherCAT communication module, if the xml description file (JN5-CMHI-ECAT\_V (latest version).xml) is needed, please download it from the TECO official website or request for it from your purchasing sales channel.

## 11.12 I/O expansion card

### 11.12.1 Hardware and data structure

This product is an I/O expansion module; it allows performing of I/O expansion functions through the SPI bus. Used with the TECO A510s/F510 AC motor driver (hereinafter referred to as a driver).

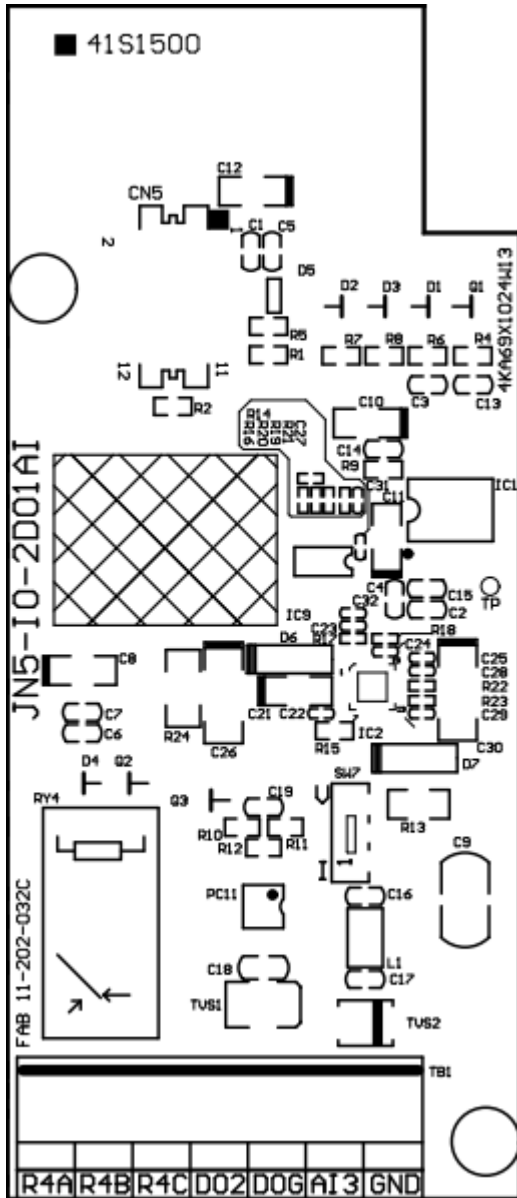

### 11.12.2 Product specifications

I/O ports

Item	Specifications
Connector	TB1 7 external contacts

## AC motor driver port

Item	Specifications
Connector	Control board CN5 connector
Transmission method	SPI high speed communication
Terminal functions	TB1 7 external contacts, applicable wire diameter: AWG 20~14 stranded wire

### 11.12.3 Installation instructions

#### Contact description

Type	Terminal	Terminal functions	Signal level
Analog input signal	AI3	Main speed command input; SW7 can be used to switch between voltage or current input (-10~10V)/(4-20mA)	-10V to +10V, (Input resistance 500KΩ) 4 to 20 mA (Input resistance: 500Ω) (12bit resolution)
	GND	Analog signal shared terminal	----
Relay Output	R4A- R4B- R4C	Relay A contact (multi-function output terminal) Relay B contact (multi-function output terminal) Relay shared terminal; please refer to the manual for its functions.	Terminal capacity: At 250Vac, 10 mA~1A At 30Vdc, 10 mA~1A
Digital Output	DO2	Multi-function (open collector transistor) output: Operating, zero speed, frequency consistent, any frequency consistent, output frequency, preparation complete, low-voltage detection, output occlusion, operation and frequency commands, over-torque detection, abnormal, low-voltage, overheat, motor over-load, frequency converter over-load output, retrying, signal abnormal, chronograph output...	48Vdc, 2 mA~50mA Optical coupling output
	DOG	Open collector transistor shared terminal	

### 11.12.4 Driver parameter setting descriptions

Please refer to group 3, 4 parameter descriptions in the manual

## 11.13 DC reactor

Installing a DC reactor at the DC terminal of the frequency converter provides the following advantages:

- Improves the input current waveform distortion caused by the rectifier in the frequency converter while maintaining continuous rectified current.
- Suppresses instantaneous current surges and prevents related overheating phenomenon caused by the rectifier and voltage regulator components due to instantaneous current surges.
- Reduces harmonic interference problems generated by the frequency converter.
- Improves and increase power factor and reduces AC component pulses at the DC terminal.
- Compared to AC reactors, the size of DC reactors are smaller and the costs are also lower.

Table 6.13 DC reactor list

Model			DC reactor	
V	HP	Rated current (A) HD/ND	Inductance value (mH)	Rated current (A)
200V 1 Ø /3 Ø	1	5/6	2.9	10
	2	8/9.6	2	15
	3	11/12	1.2	20
200V 3 Ø	5.4	17.5/22	0.78	35
	7.5	25/30	0.57	45
	10	33/42	0.39	65
	15	47/56	0.29	85
	20	60/69	0.23	105
	25	73/79	0.2	120
	30	85/110	0.14	165
	40	115/138	0.12	210
	50 (built-in)	145/169	0.1	200
	60 (built-in)	180/200	0.08	260
	75 (built-in)	215/250	0.08	390
	100 (built-in)	283/312	0.08	390
125 (built-in)	346/400	0.065	520	
150 (built-in)	415/450	0.05	800	
400V 3 Ø	1	3.4/4.1	10.2	6.5
	2	4.2/5.4	7	8.5
	3	5.5/6.9	4.2	11

Model			DC reactor	
V	HP	Rated current (A) HD/ND	Inductance value (mH)	Rated current (A)
	5.4	9.2/12.1	2.8	20
	7.5	14.8/17.5	2.1	30
	10	18/23	1.4	35
	15	24/31	1.0	50
	20	31/38	0.83	60
	25	39/44	0.7	70
	30	45/58	0.51	90
	40	60/73	0.41	115
	50	75/88	0.34	140
	60	91/103	0.28	160
	75	118/145	0.2	230
	100 (built-in)	150/168	0.18	240
	125 (built-in)	180/208	0.15	240
	150 (built-in)	216/250	0.22	290
	175 (built-in)	260/296	0.15	370
	215 (built-in)	295/328	0.15	370
	270 (built-in)	380/435	0.12	520
	300 (built-in)	450/515	0.08	800
	375 (built-in)	523/585	0.08	800
	425 (built-in)	585/585	0.08	800

Note: When using DC reactors, please first remove the short-circuit copper sheet between the P1 and P2 terminals, and then fix the current reactor on these two terminals.

## 11.14 Sinusoidal output reactor

The parasitic inductance and capacitance that exist in the frequency converter and motor wiring are determined by the component switching speed and wiring of the frequency converter. The voltage of the motor terminal will reach as high as twice the DC voltage of the frequency converter. LC resonance may cause surge voltages at the motor terminal and cause danger. Installing an AC reactor at the frequency converter output can suppress voltages (dv/dt). If the wiring length is too long, suppression of surge voltages will become more difficult. Installing a sinusoidal output reactor at the output terminal of the frequency converter can prevent the motor terminal voltage from generating surges.

Table 6.14 Sinusoidal output reactor list

Model			Output reactor	
V	HP	Rated current (A) HD/ND	Inductance value (mH)	Rated current (A)
200V 1 Ø / 3 Ø	1	5/6	0.61	6
	2	8/9.6	0.38	9.6
	3	11/12	0.31	12
200V 3 Ø	5.4	17.5/22	0.17	22
	7.5	25/30	0.12	30
	10	33/42	0.09	42
	15	47/56	0.07	56
	20	60/69	0.05	69
	25	73/79	0.05	79
	30	85/110	0.03	110
	40	115/138	0.03	138
	50	145/169	0.02	169
	60	180/200	0.017	200
	75	215/250	0.013	250
	100	283/312	0.013	312
	125	346/400	0.008	400
150	415/450	0.008	450	
400V 3 Ø	1	3.4/4.1	1.7	4.1
	2	4.2/5.4	1.29	5.4
	3	5.5/6.9	1.01	6.9
	5.4	9.2/12.1	0.58	12.1
	7.5	14.8/17.5	0.4	17.5
	10	18/23	0.3	23
	15	24/31	0.23	31

Model			Output reactor	
V	HP	Rated current (A) HD/ND	Inductance value (mH)	Rated current (A)
	20	31/38	0.18	38
	25	39/44	0.16	44
	30	45/58	0.12	58
	40	60/73	0.1	73
	50	75/88	0.08	88
	60	91/103	0.07	103
	75	118/145	0.05	145
	100	150/168	0.04	168
	125	180/208	0.032	208
	150	216/250	0.027	250
	175	260/296	0.023	296
	215	295/328	0.021	328
	270	380/435	0.015	435
	300	450/515	0.012	515
	375	523/585	0.012	585
425	585/585	0.012	585	

Model			Output reactor	
V	HP	Rated current ND (A)	Inductance value (mH)	Rated Current (A)
575V 3 Ø	1	3	1.47	4
	2	4.2	1.05	5
	3	5.8	0.76	8
	4	8.8	0.5	11
	7.5	12.2	0.36	16
	10	14.5	0.30	19
690V 3 Ø	15	19	0.28	25
	20	22	0.24	29
	25	27	0.2	35
	30	34	0.16	44
	40	42	0.13	55
	50	52	0.1	68
	60	62	0.09	81
	75	80	0.07	104
100	99	0.05	129	

Model			Output reactor	
V	HP	Rated current ND (A)	Inductance value (mH)	Rated Current (A)
	125	125	0.04	163
	150	147	0.04	191
	175	163	0.03	212
	215	212	0.02	276
	250	216	0.02	281
	270	246	0.02	320

- Note: 1. The frequency converter has improved IGBT equipment and soft-switching driver circuit; compared to previous models, it can improve dv/dt by approximately 50% terminal voltage.
2. The purposes of installing sinusoidal output filters are as follows:
- Prolong motor life.
  - Reduce motor interference.
  - Reduce frequency converter pulse load.
  - Improve system stability and efficiency.

## 11.15 DC24V power expansion card

This product allows parts of the communication or driver functions to operate normally before connecting power to the inverter.

### 11.15.1 JN5-PS-DC24V product specifications

#### Connection terminal

Item	Specifications
Input terminal	24V: 24V±5%, 0.6A 0V: 24V reference ground
Notes	The terminals above cannot be connected to the power and terminals on the frequency converter itself in order to achieve the goal of safety isolation.



## 11.16 EtherNet/IP Communication Card (JN5-CMHI-EIP)

### 11.16.1 Preparations before using the instrument

- A510s or F510 Enhanced series inverter \*1
- IBM PC or compatible computer (with the following related software installed) \*1
  - BOOTP-DHCP Tool (Rockwell IP setting software)
  - RSlinx Classic (Rockwell communication software)
  - Connected Components Workbench (Rockwell PLC software)
  - Molex Ethernet/IP Tool (Ethernet IP setting software)
- 12 pin cable (4KA97X1695T01 or 4KA97X1696T01) \*1
- Ethernet/IP Programmable Logic Controller (EX: Micro820) \*1
- CAT5e Ethernet cable \*2

### 11.16.2 Installation of a semi-finished product

- Open the top cover of the inverter and install the communication card CN5 to the control board CN2 using a cable (4KA97X1695T01 or 4KA97X1696T01).
  
- A510s / F510 Enhanced inverter parameter settings

Run command	Communication method	00-02=2
Frequency command	Communication method	00-05=5
Acceleration time	10.0s	00-14=100
Deceleration time	10.0s	00-15=100

### 11.16.3 Connection steps

- Connect with the PC network and set the IP (as shown in the figure below, set the PC network card IP).

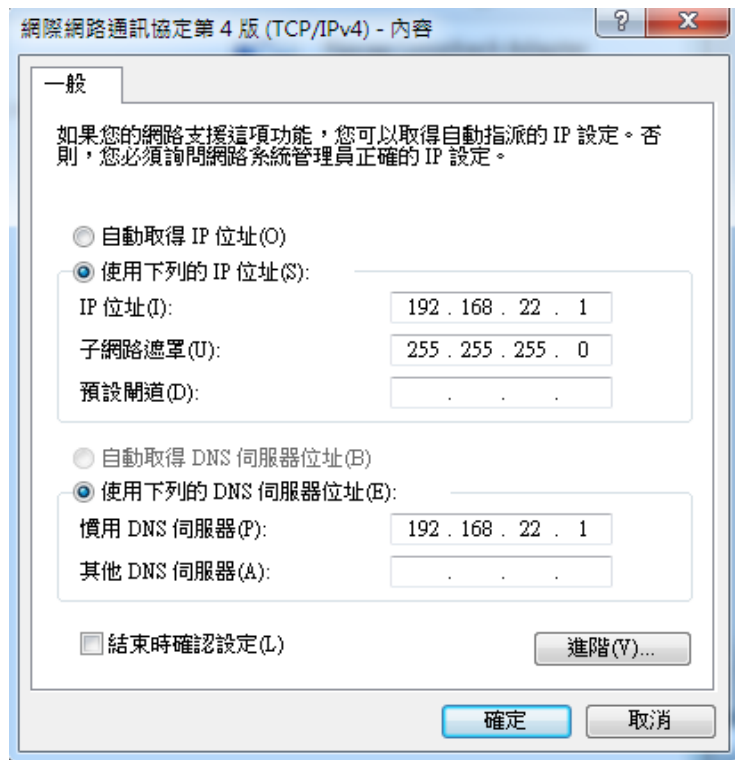

- Execute the Rockwell BOOTP-DHCP Tool and select the PC network card

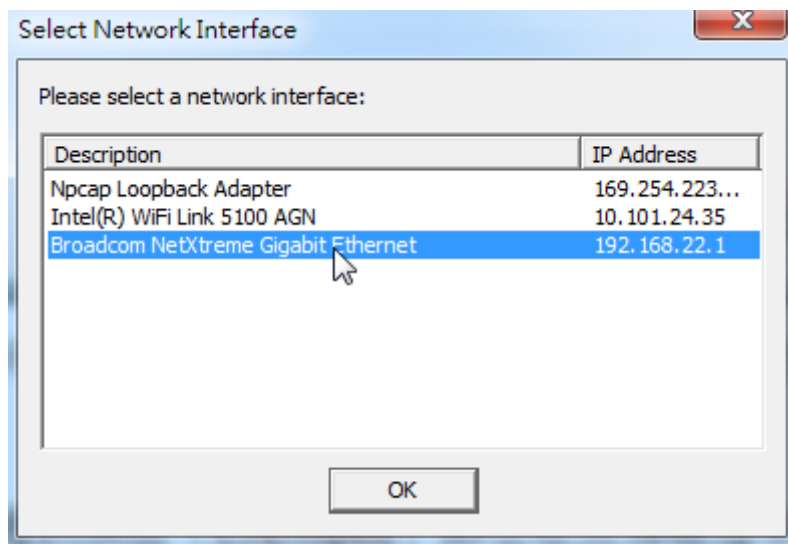

- The Rockwell BOOTP-DHCP Tool scans the MAC Address of the communication module, then select ADD RELATION and set the CLIENT IP ADDRESS to 192.168.22.2

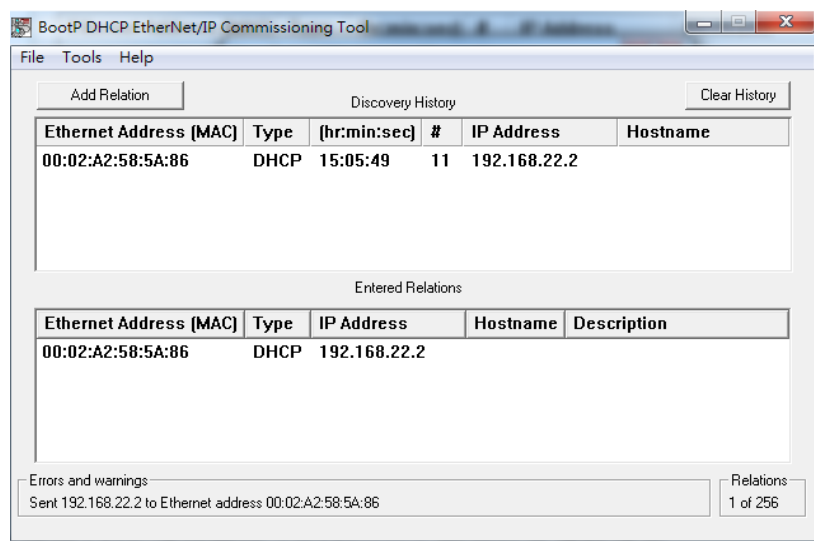
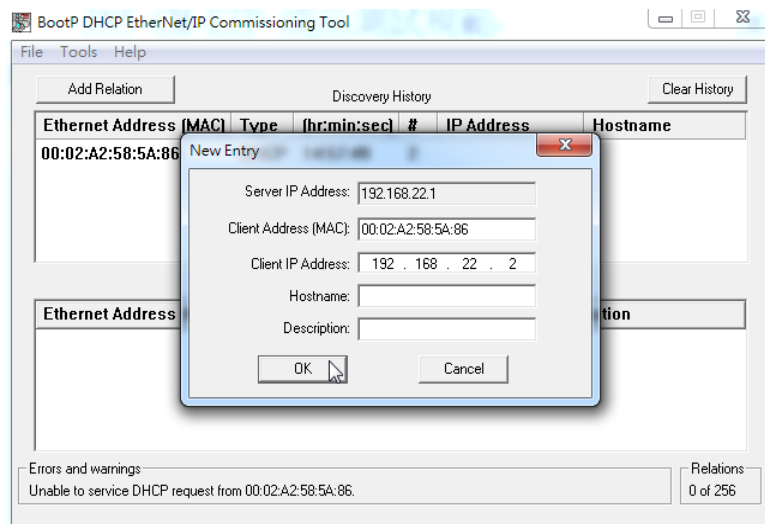
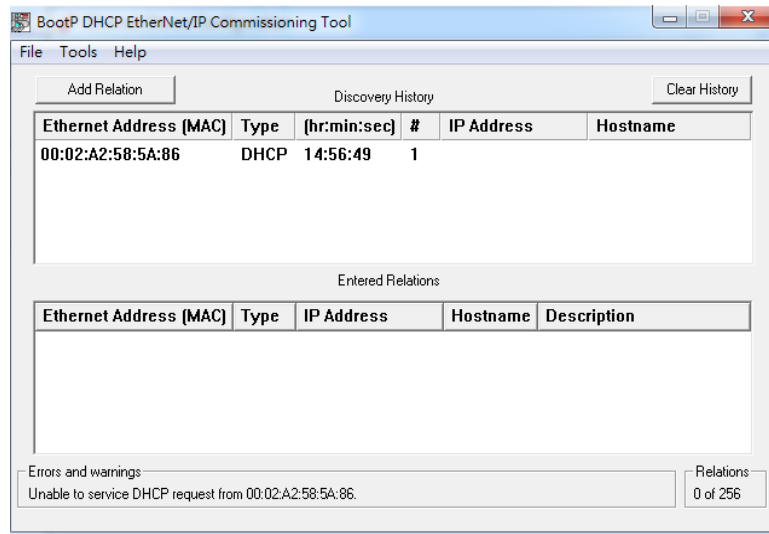

- Set and confirm the IP status (using Micro820 as the example) of the A510s/F510 communication card (Ethernet/IP).

Execute Connected Components Workbench, open a Project file and set the Micro800 PLC address (192.168.22.4) and subnet mask (255.255.255.0); they do not need to be changed again after the setting is completed

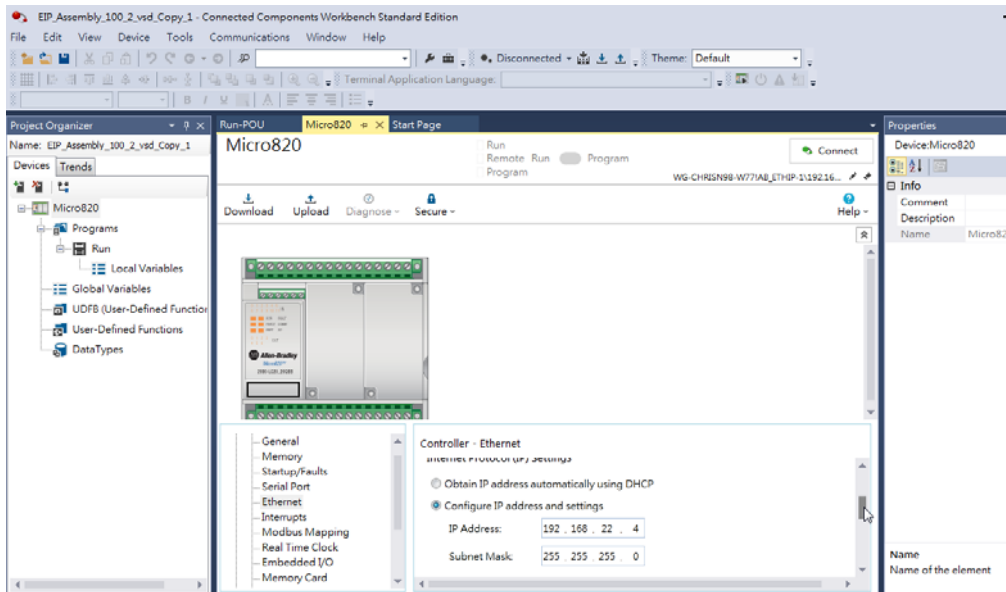

Check whether the network connection is successful, as shown in the figure below. Execute RSLinx Classic Lite and execute Configure Drivers

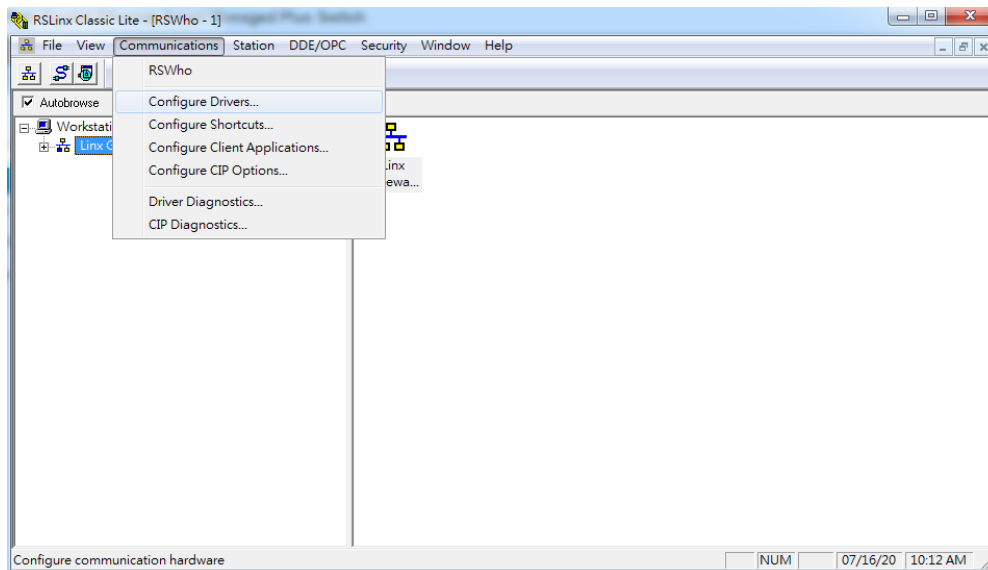

Select Ethernet/IP Driver, Add new, and select the IP of the PC network card

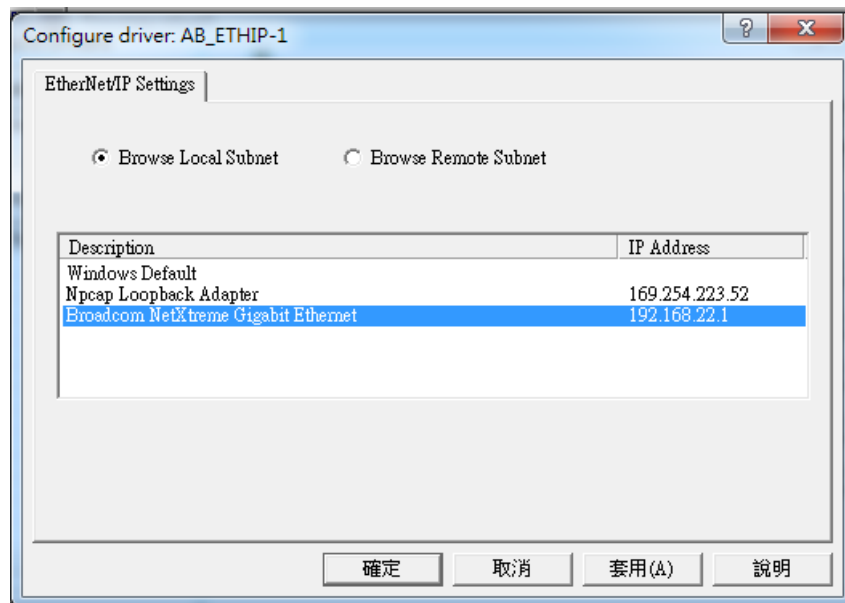
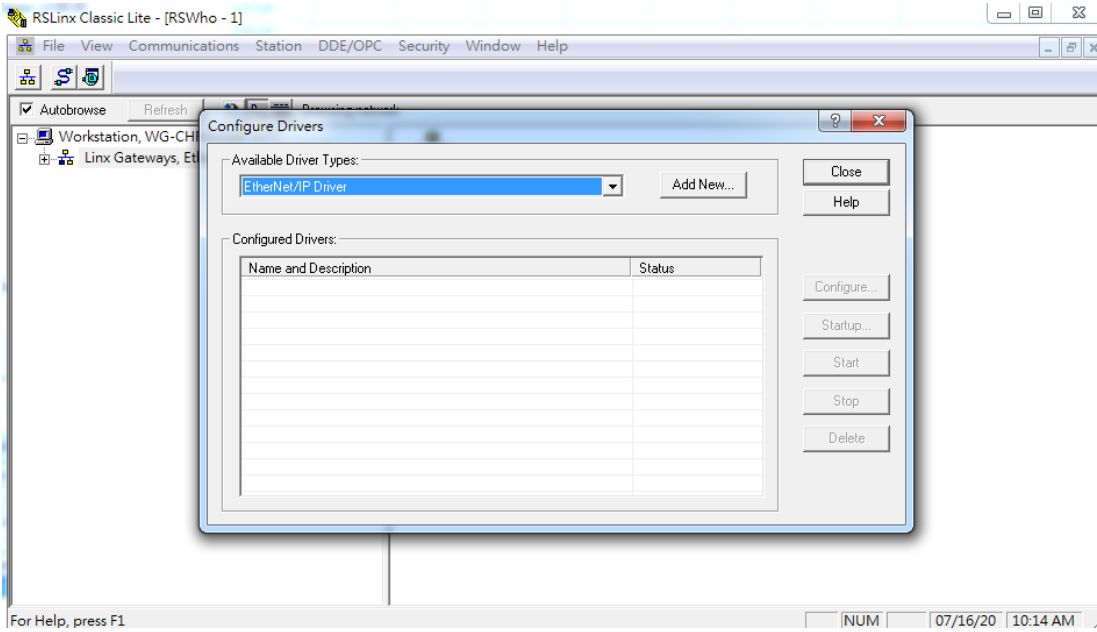

Expand AB\_ETHIP-1, the PLC (192.168.22.4) and communication card (192.168.22.2) can be seen

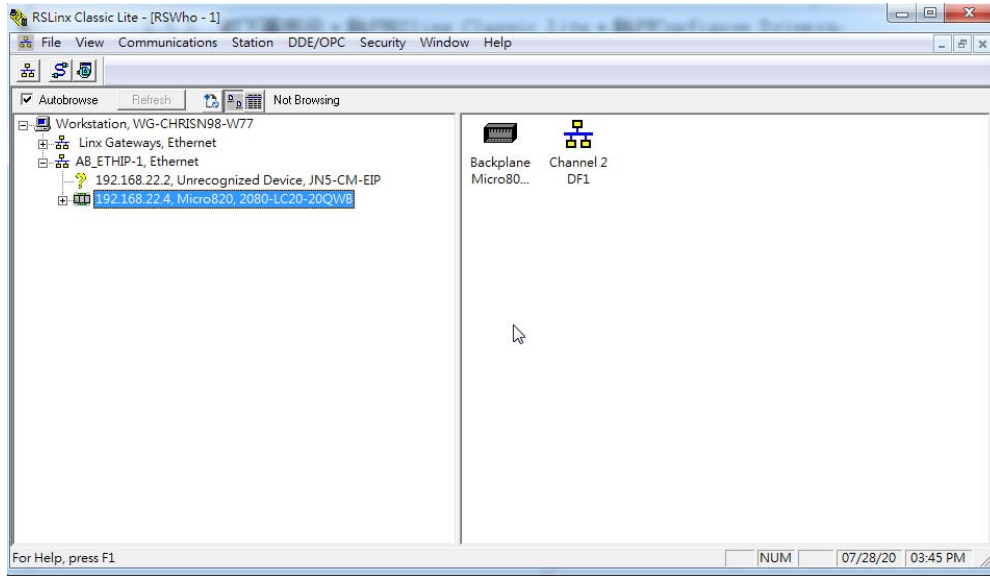

Open the CCW project file and confirm that the IP DHCP is assigned to the expansion card for Local Variables -> A\_TarCfg.Path is 192.168.22.2

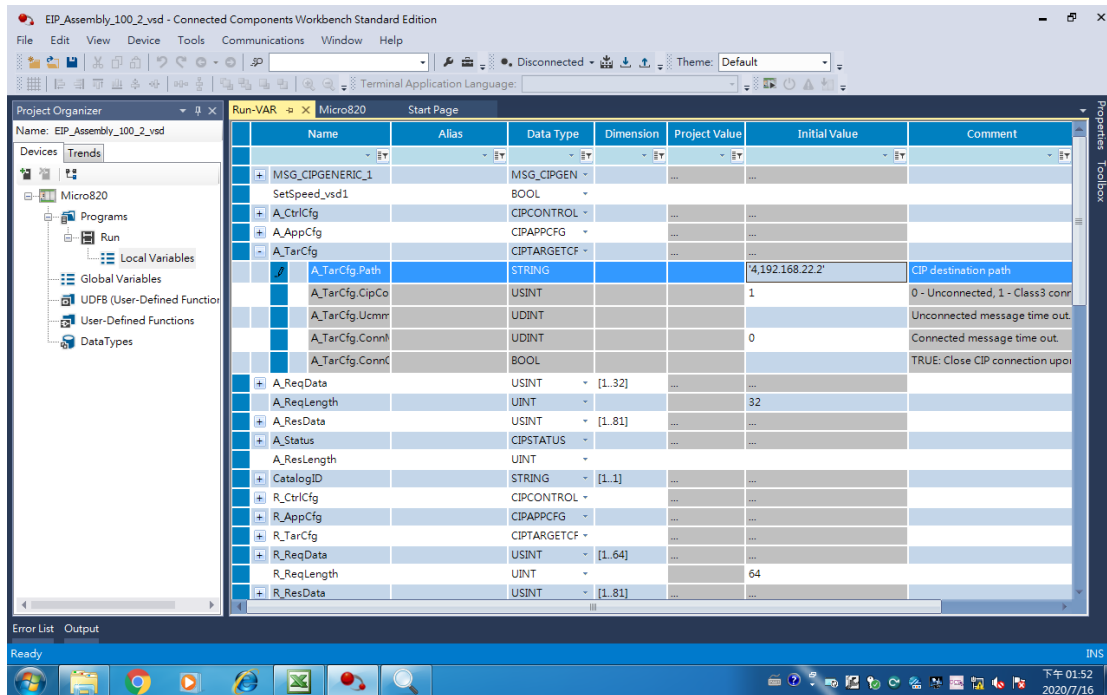

- Set the “Connected Components Workbench” communication software.

Open the “Connected Components Workbench” communication software as shown in the figure below, select the connected device and select “Local Variables.” Confirm that the IP DHCP assigned to the expansion card is 192.168.22.2 for A\_TarCfg.Path.

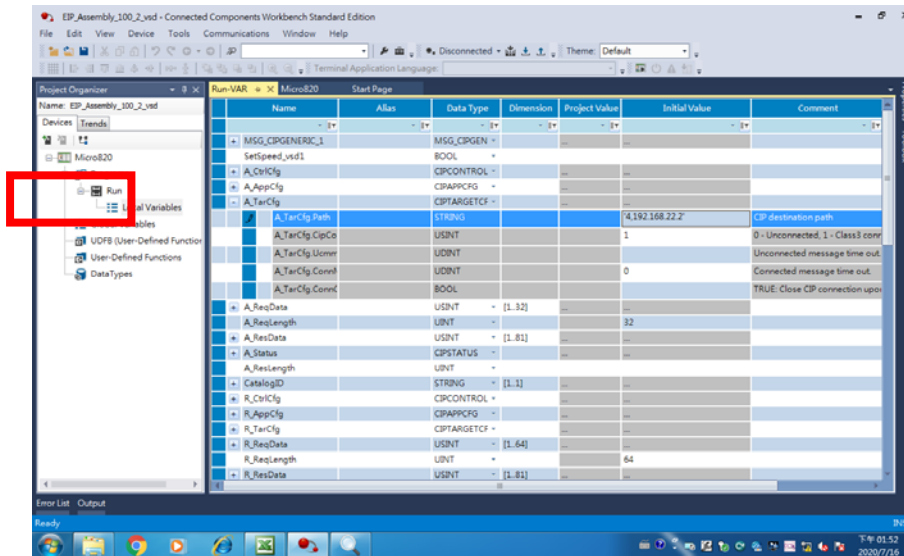

Select “Build Project”

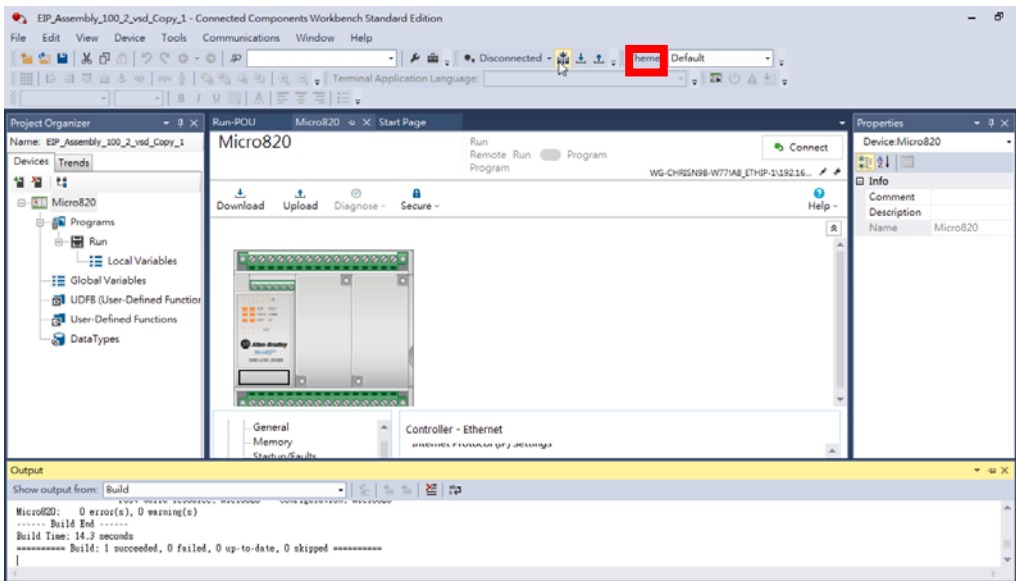

Press the “Download” button to complete the USB to PLC setting.

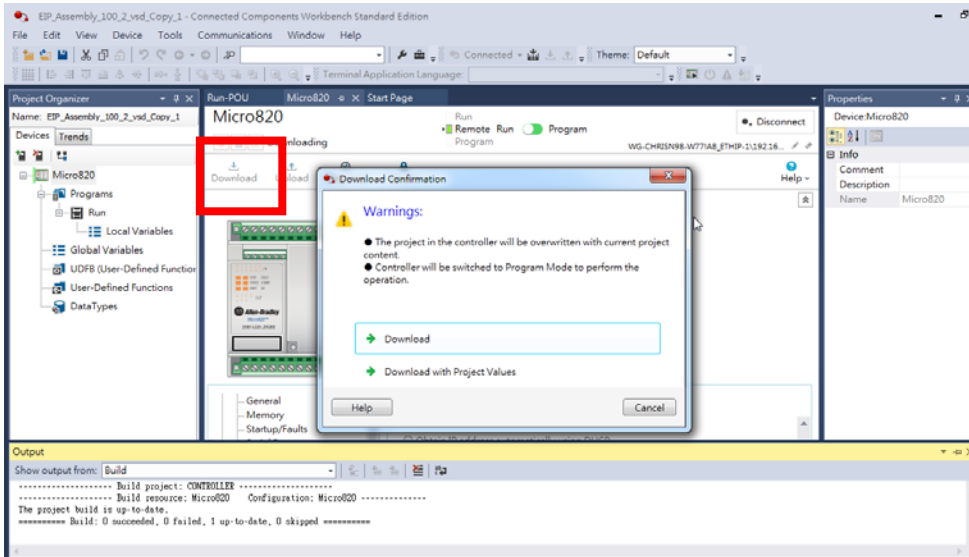

The download will execute the connection between the communication card and PLC automatically, as shown in the figure below.

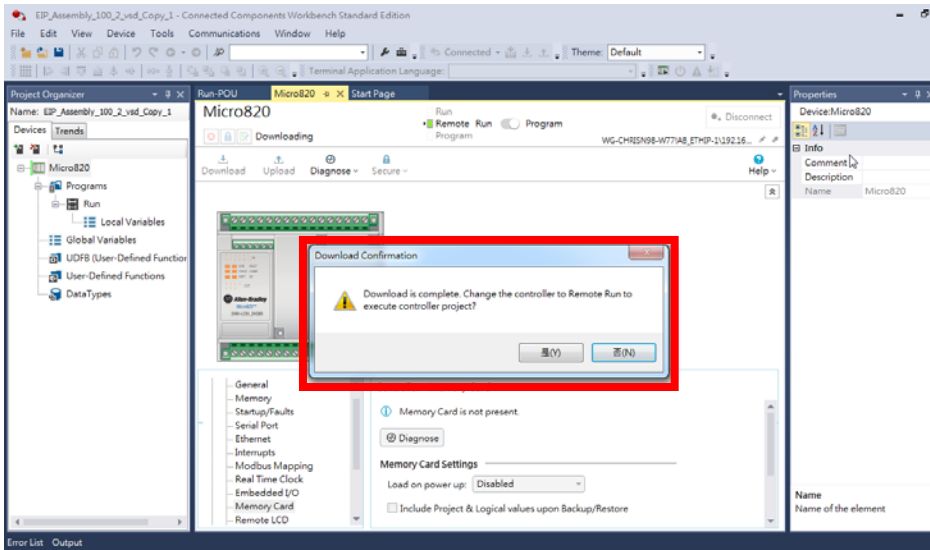



## 11.16.4 Running

- The connected A510s/F510 communication card (Ethernet/IP), as shown in the figure below.

Confirm that Remote Run is enabled.

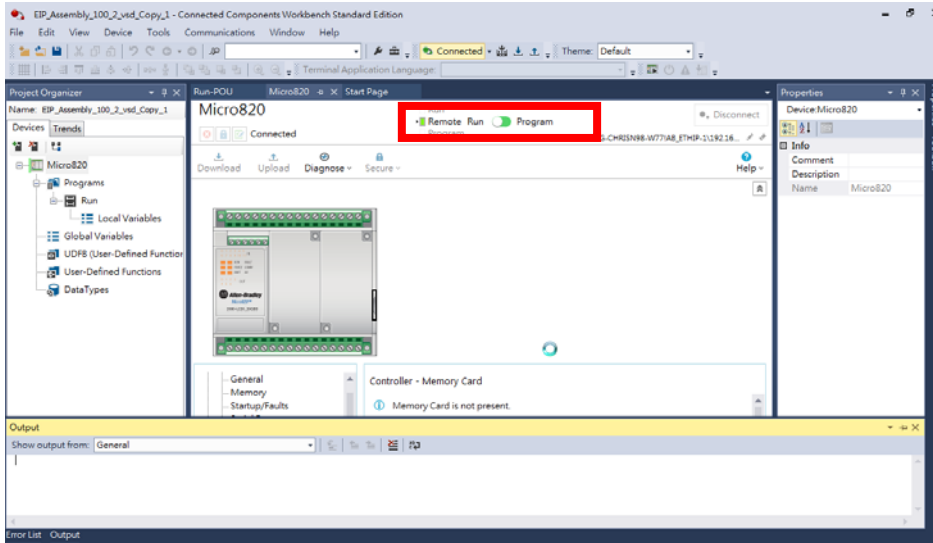

As shown in the figure below, select and open “RUN\_POU.”

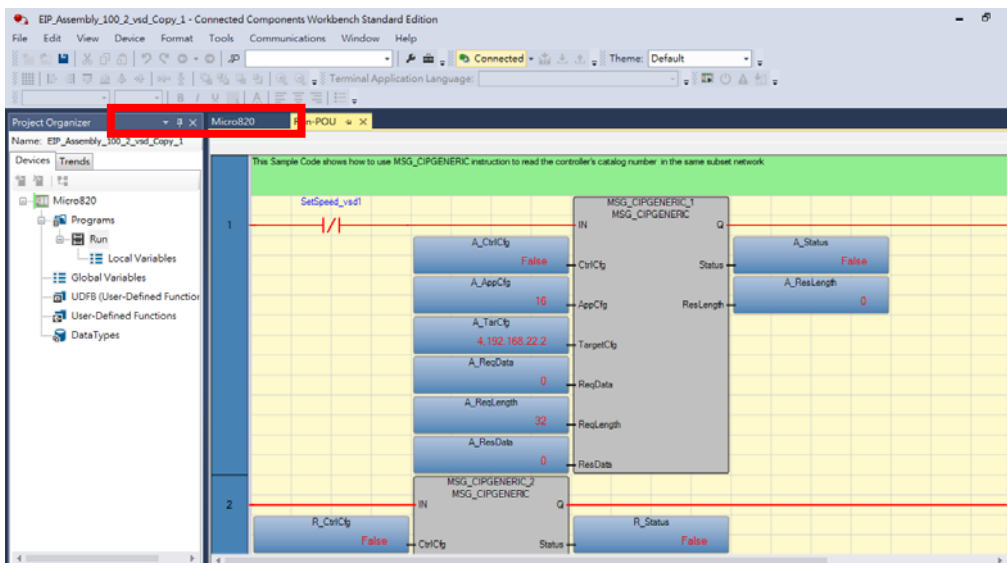

Load A\_ReqData and check whether the Input Assembly content was written.

PLC command location	MODBUS register location	Description
A_ReqData[1]	2501 Low Byte	RUN/STOP
A_ReqData[2]	2501 High Byte	
A_ReqData[3]	2502 Low Byte	Frequency command
A_ReqData[4]	2502 High Byte	

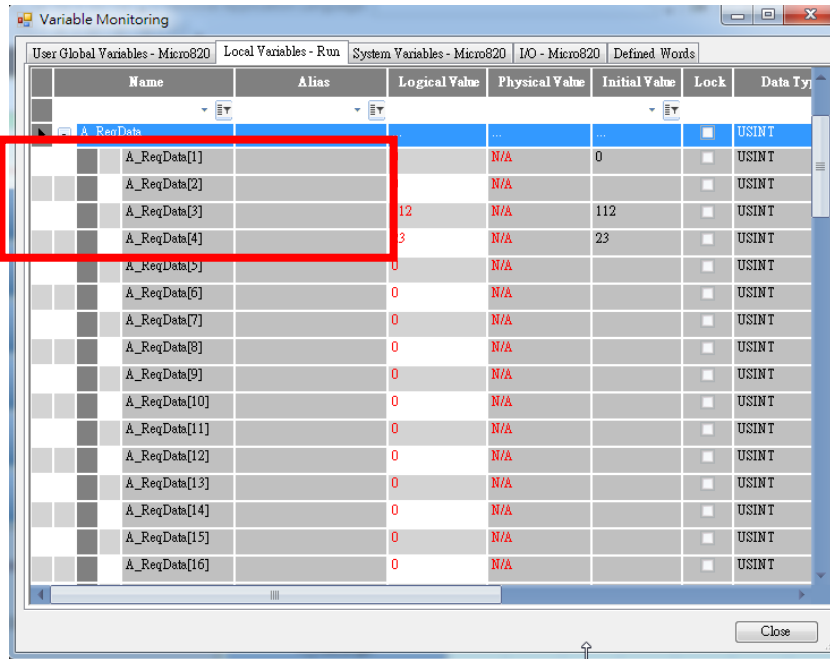

Load R\_ResData and check whether the Output Assembly content was read.

PLC command location	MODBUS register location	Description
R_ResData[1]	2520 Low Byte	Motor drive status
R_ResData[2]	2520 High Byte	
R_ResData[3]	2521 Low Byte	Error description
R_ResData[4]	2521 High Byte	
R_ResData[5]	2522 Low Byte	DI status
R_ResData[6]	2522 High Byte	
R_ResData[7]	2523 Low Byte	Frequency command
R_ResData[8]	2523 High Byte	
R_ResData[9]	2524 Low Byte	Output frequency
R_ResData[10]	2524 High Byte	

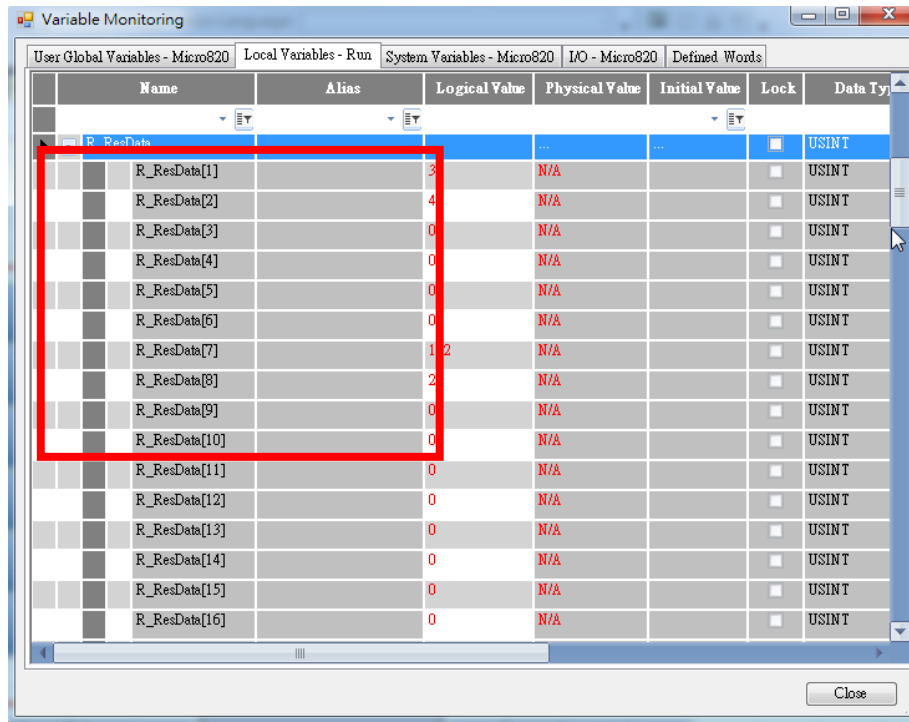

Execute Molex Ethernet/IP Tool and send the UCMM read command (Get Attribute) to the A510s/F510 communication card (Ethernet/IP); the response that can be received from the communication card is as shown in the figure below.

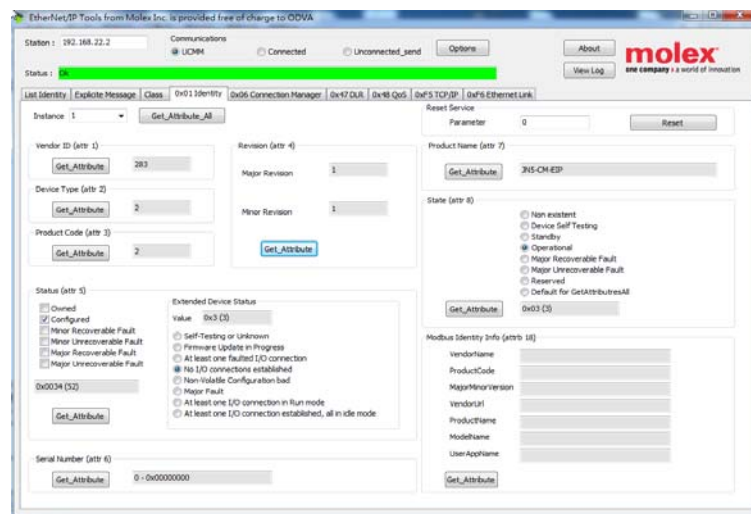

Class	Instance	Attribute	Name	Default Value	R/W	Size
0x01	1	1	Vendor ID	283	R	U32
0x01	1	2	Device Type	2	R	U32
0x01	1	3	Product code	2	R	U32
0x01	1	4	Major Revision	1	R	U32
0x01	1	5	Minor Revision	1	R	U32

The run command sent to the motor drive written with the PLC command is as follows

Commands can be sent to the motor drive through PLC from the following switch

## A\_ReqData[1] motor drive operation signal (2501H)

PLC command location	Function	Description
A_ReqData[1].0	Operation status	1 : RUN 0 : STOP
A_ReqData[1].1	Direction status	1 : REV 0 : FWD
A_ReqData[1].2	External error	1:EF0
A_ReqData[1].3	Error reset	1 : RESET

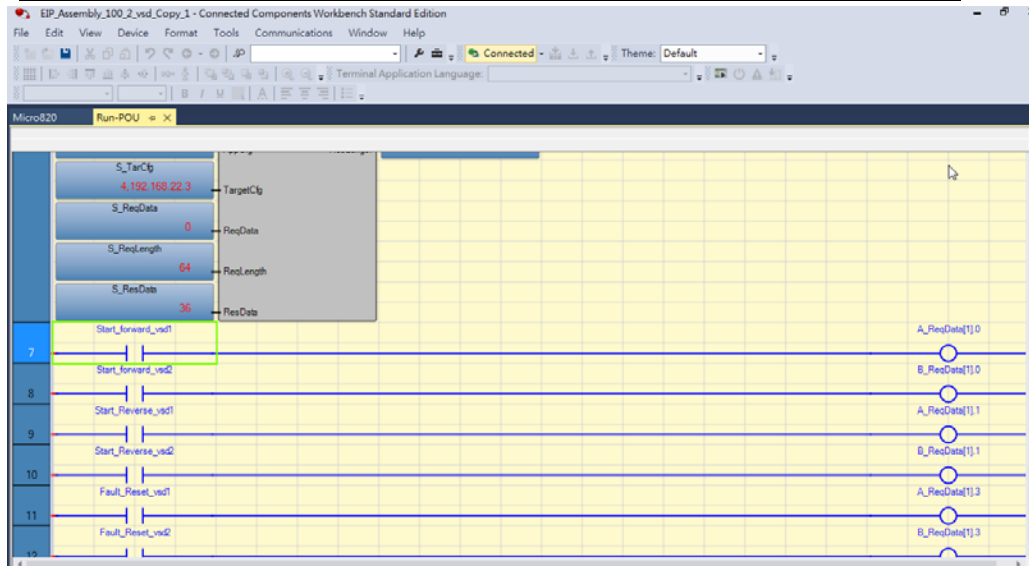

The run command sent to the motor drive written with the Molex Ethernet/IP Tool is as follows

Service Code No.	Service Name
0E(HEX)	Get Attribute Single
10(HEX)	Set Attribute Single

Class(HEX)	2A	29	29
Instance(HEX)	1	1	1
Attribute(HEX)	8	3	3
Write data(HEX)	0~70 17	0~1	0~3
Corresponding command	SPEED REFERENCE	1:RUN FORWARD 0: STOP	1:REVERSE RUN 0: STOP
Inverter action	Panel frequency 60Hz	Forward rotation	Reversed rotation

## 11.17 JN5-CM-EIP Manual

### 11.17.1 Preparations before using the instrument

- 510 series inverter \*1
- IBM PC or compatible computer (with the following related software installed) \*1
  - BOOTP-DHCP Tool (Rockwell IP setting software)
  - RSlinx Classic (Rockwell communication software)
  - Connected Components Workbench (Rockwell PLC software)
  - Molex Ethernet/IP Tool (Ethernet IP setting software)
- Ethernet/IP Programmable Logic Controller (EX: Micro820) \*1
- CAT5e Ethernet cable \*3
- DC Power supply \*1

### 11.17.2 Installation of a semi-finished product

- Connected the power terminal of the module to the DC power supply.
- Open the top cover of the inverter, and connect the CN1 of the communication module to the RJ45 communication port of the inverter by CAT5e cable.
- 510 inverter parameter settings

Run command	Communication method	00-02=2
Frequency command	Communication method	00-05=5
Acceleration time	10.0s	00-14=100
Deceleration time	10.0s	00-15=100

Note: CN1 position



### 11.17.3 Connection steps

- Connect with the PC network and set the IP (as shown in the figure below, set the PC network card IP).

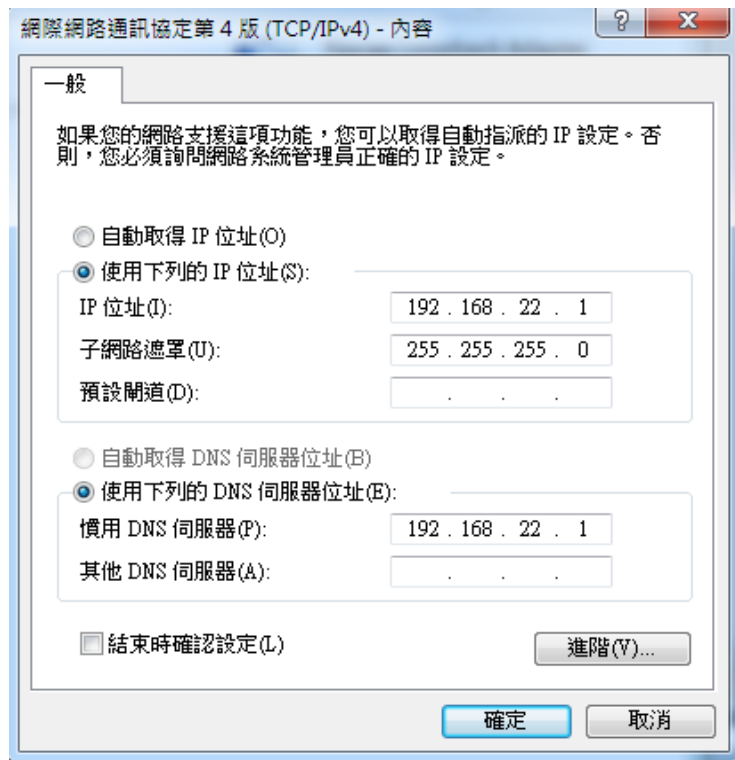

- Execute the Rockwell BOOTP-DHCP Tool and select the PC network card

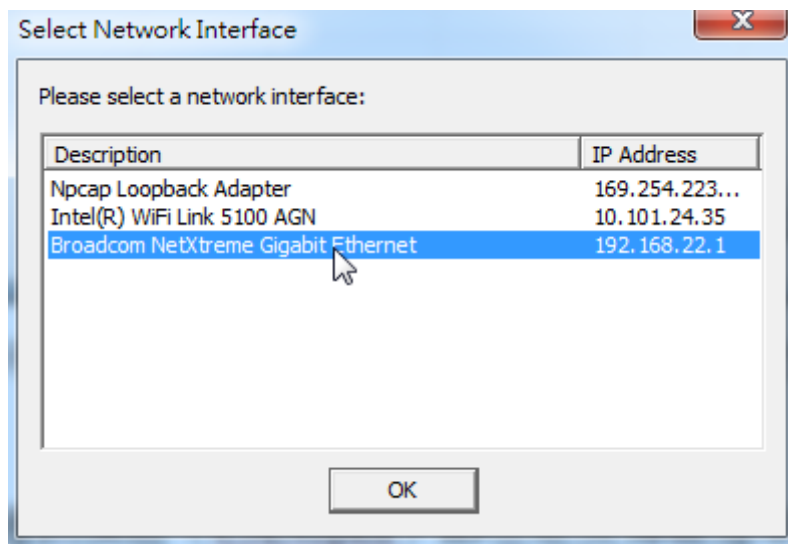

- The Rockwell BOOTP-DHCP Tool scans the MAC Address of the communication module, then select ADD RELATION and set the CLIENT IP ADDRESS to 192.168.22.2

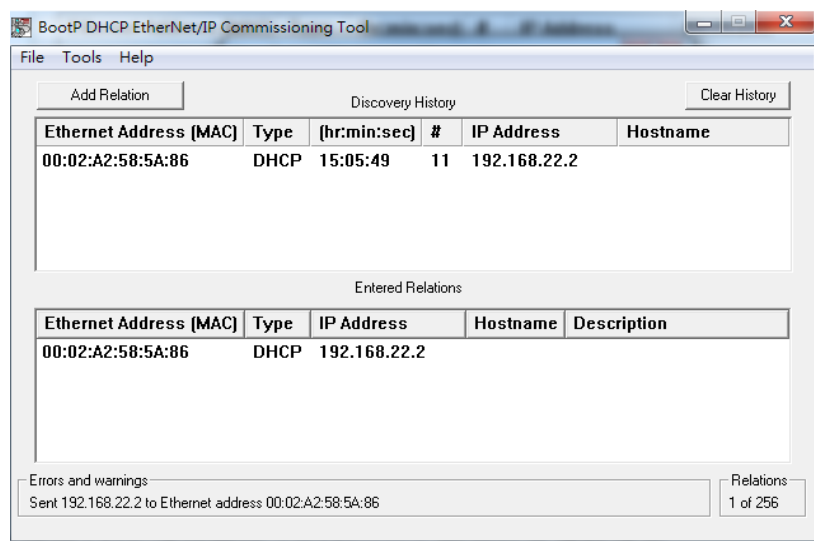
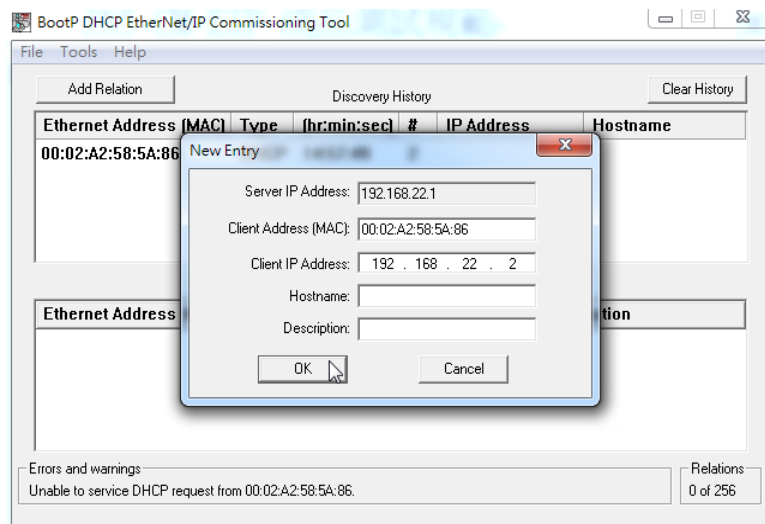
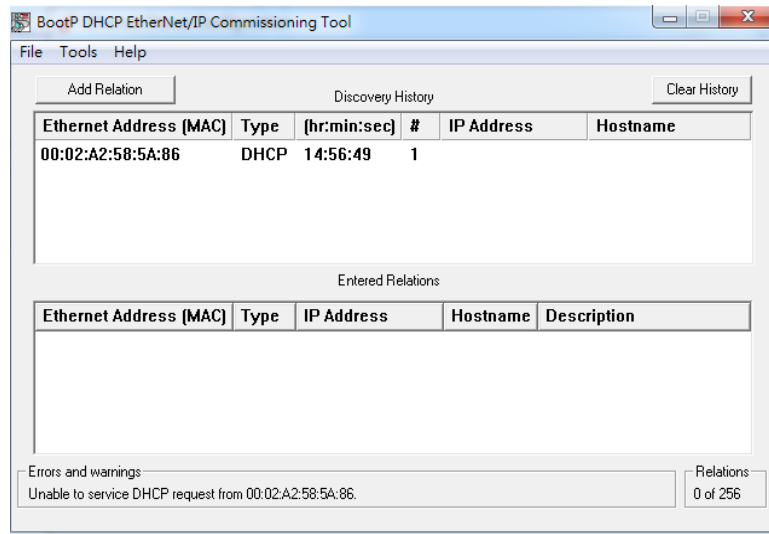

- Set and confirm the IP status (using Micro820 as the example) of the 510 communication module (Ethernet/IP).

Execute Connected Components Workbench, open a Project file and set the Micro800 PLC address (192.168.22.4) and subnet mask (255.255.255.0); they do not need to be changed again after the setting is completed

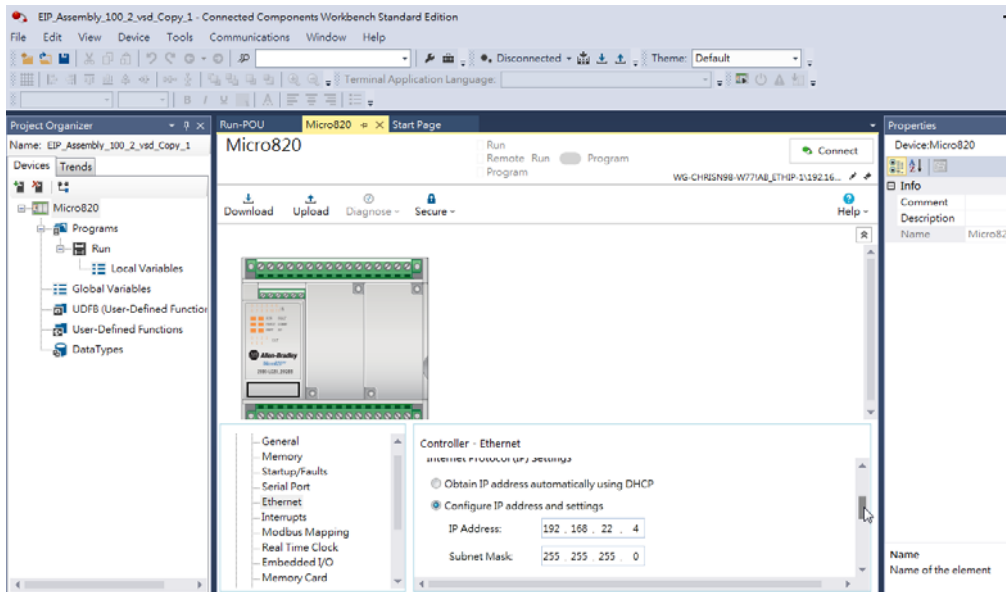

Check whether the network connection is successful, as shown in the figure below. Execute RSLinx Classic Lite and execute Configure Drivers.

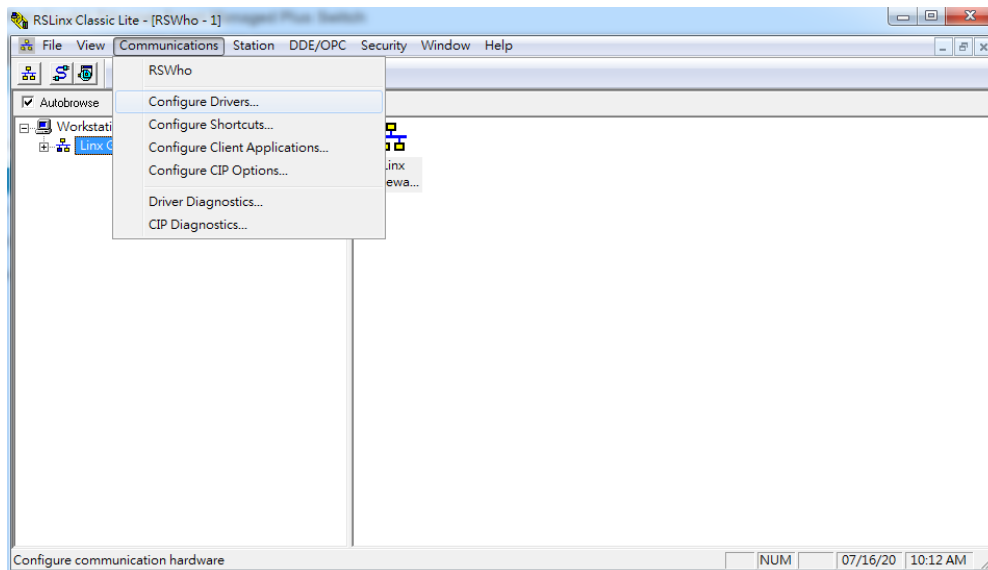



Select Ethernet/IP Driver, Add new, and select the IP of the PC network card

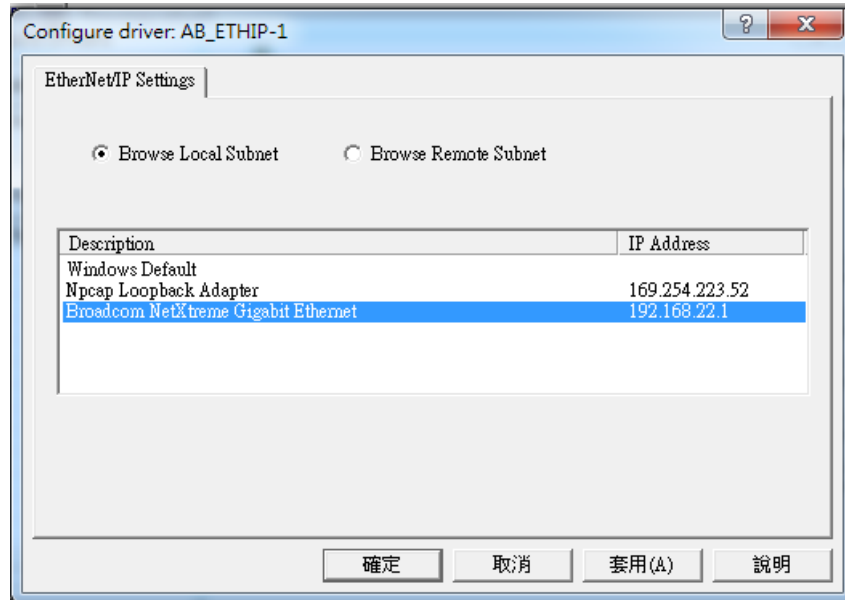
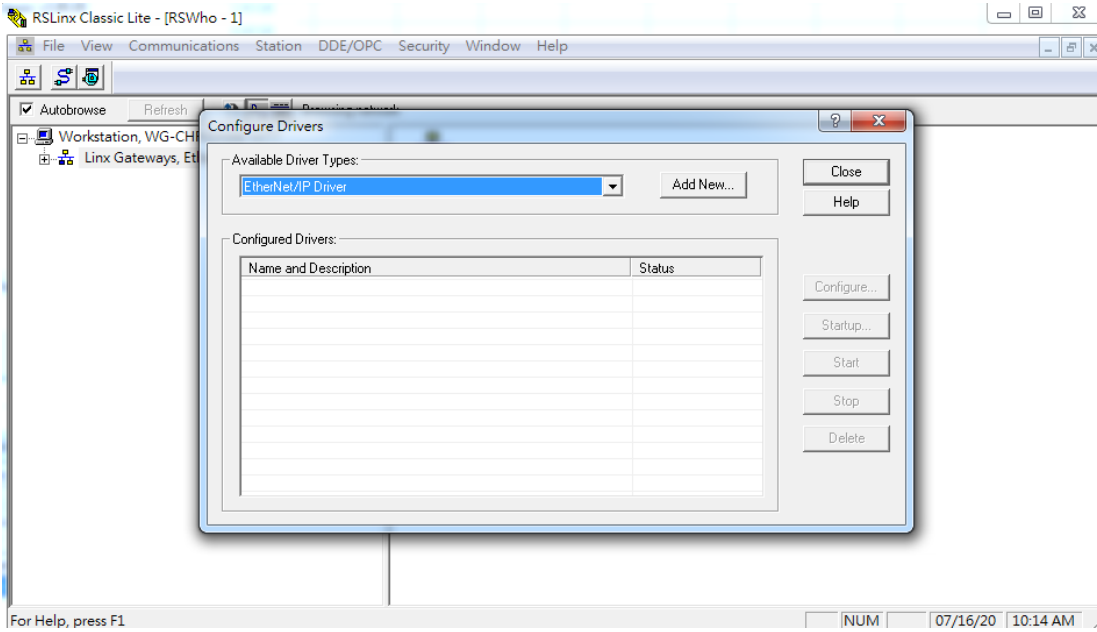

Expand AB\_ETHIP-1, the PLC (192.168.22.4) and the communication module (192.168.22.2) can be seen.

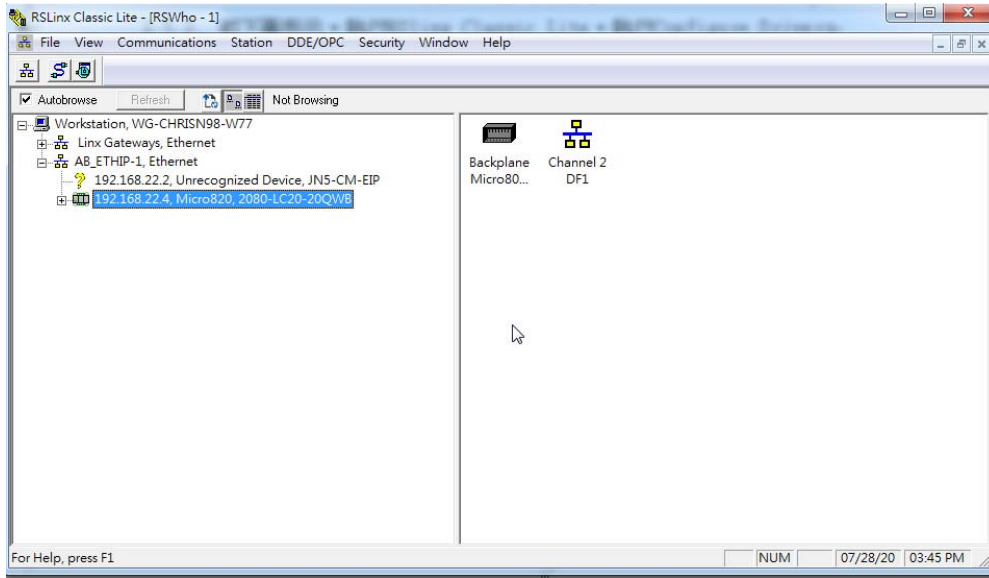

Open the CCW project file and confirm that the IP DHCP is assigned to the expansion card for Local Variables -> A\_TarCfg.Path is 192.168.22.2.

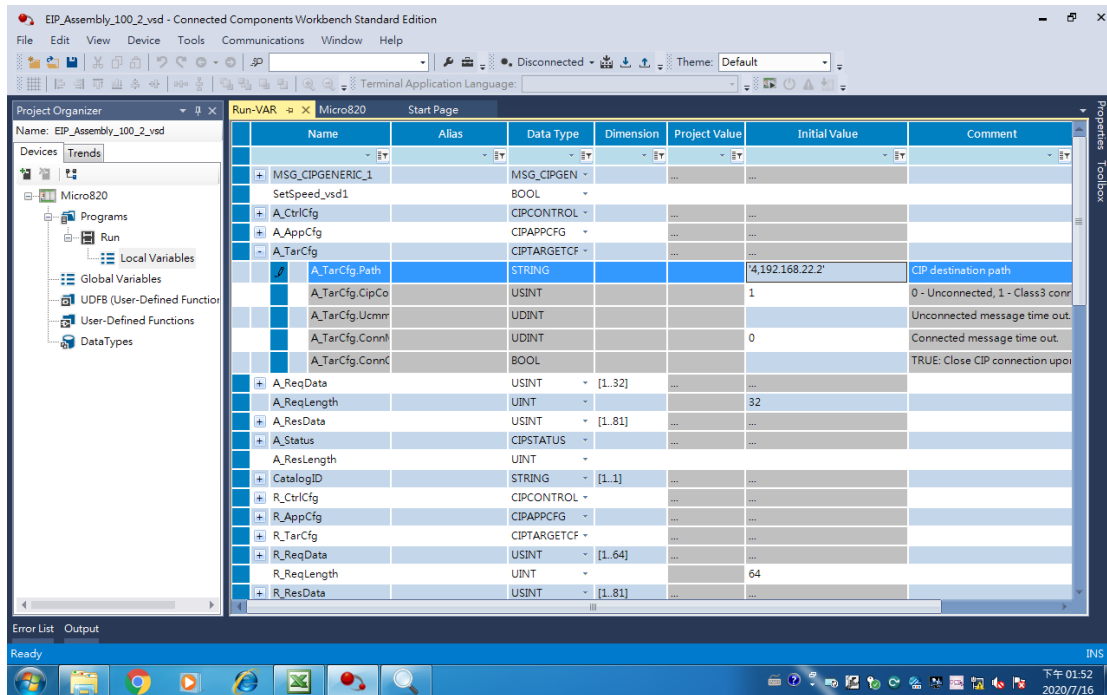

- Set the “Connected Components Workbench” communication software.

Open the “Connected Components Workbench” communication software as shown in the figure below, select the connected device and select “Local Variables.” Confirm that the IP DHCP assigned to the expansion card is 192.168.22.2 for A\_TarCfg.Path.

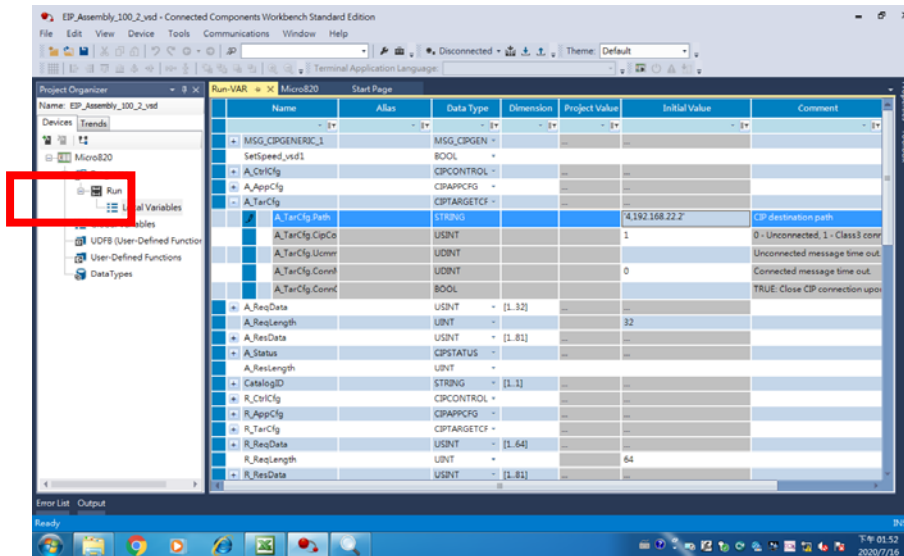

Select “Build Project”

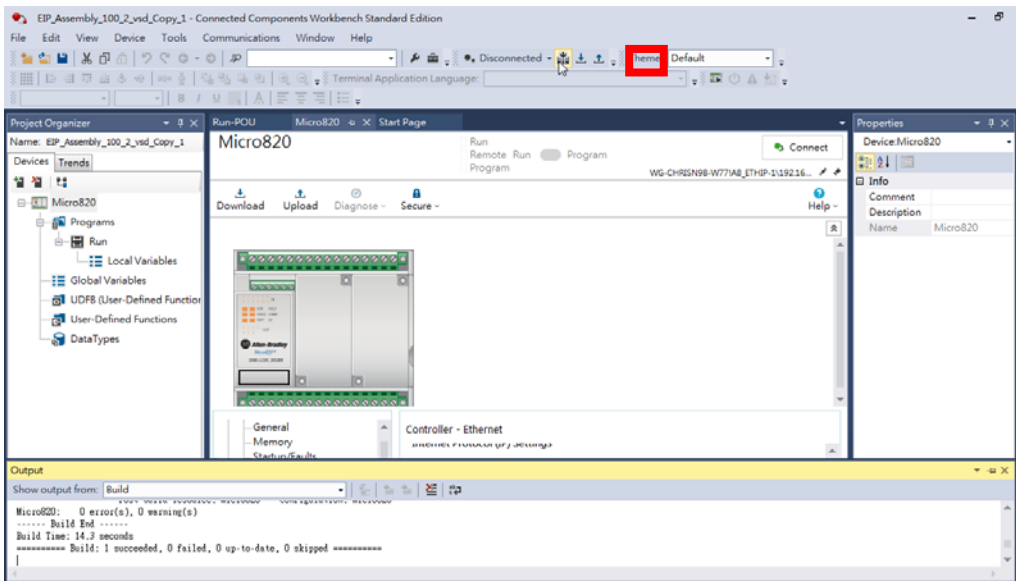

Press the “Download” button to complete the PC to PLC setting.

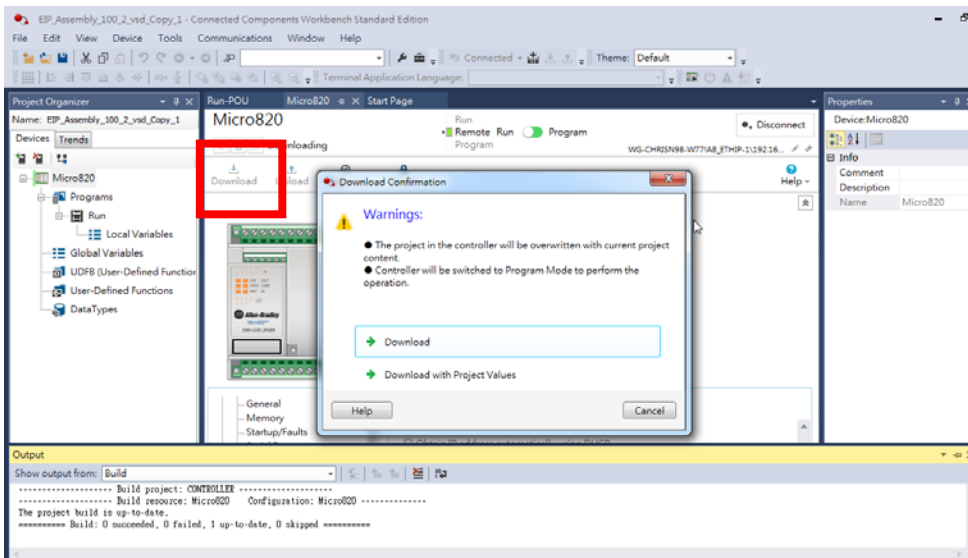

After download, it will execute the connection between the communication module and PLC automatically, as shown in the figure below.

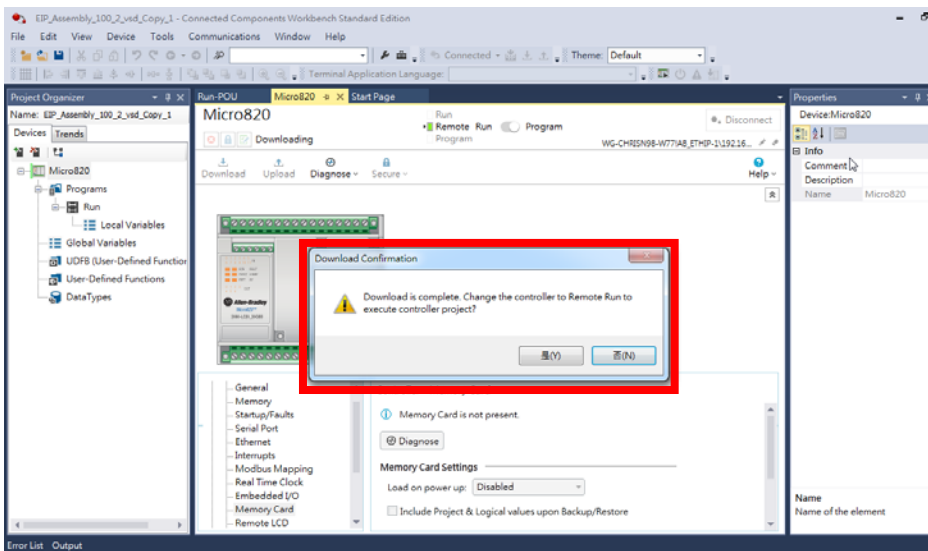

## 11.17.4 Running

- The connected 510 communication module (Ethernet/IP), as shown in the figure below.

Confirm that Remote Run is enabled.

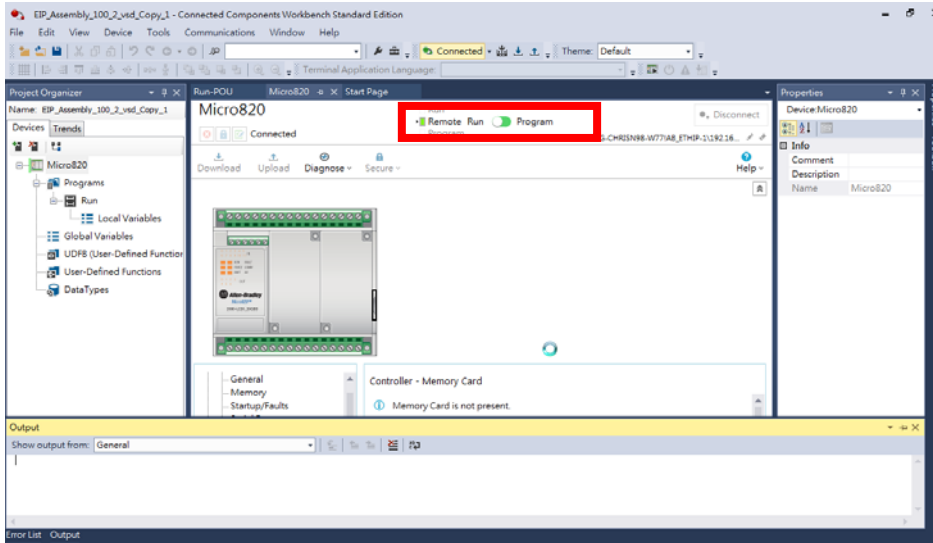

As shown in the figure below, select and open “RUN\_POU.”

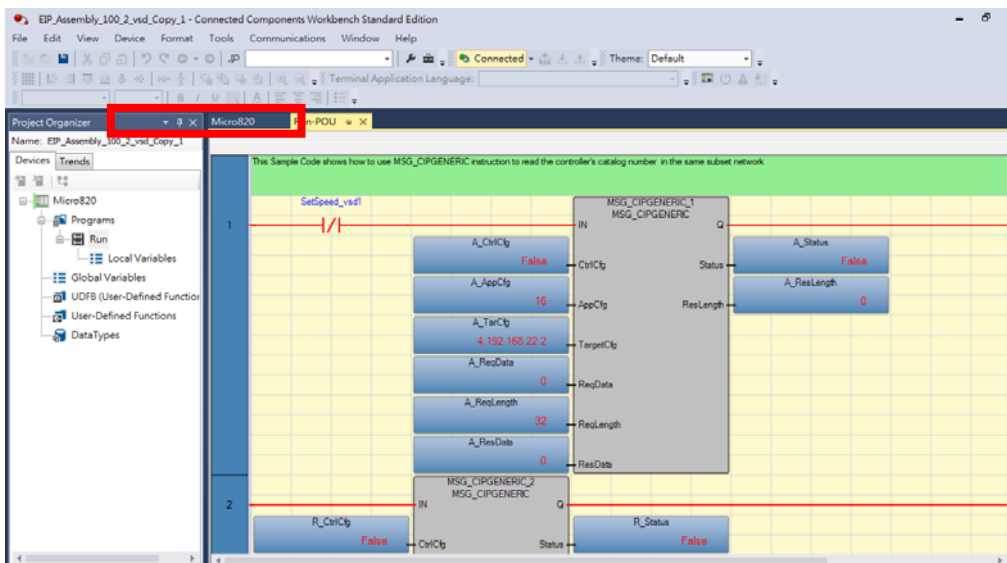

Load A\_ReqData and check whether the Input Assembly content was written.

PLC command address	MODBUS register address	Description
A_ReqData[1]	2501 Low Byte	RUN/STOP
A_ReqData[2]	2501 High Byte	
A_ReqData[3]	2502 Low Byte	Frequency command
A_ReqData[4]	2502 High Byte	

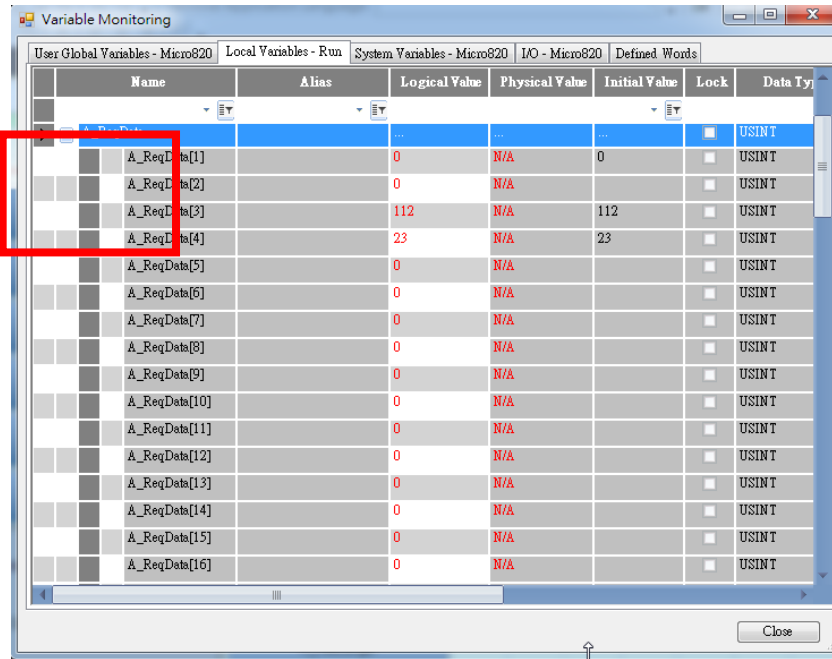

Load R\_ResData and check whether the Output Assembly content was read.

PLC command address	MODBUS register address	Description
R_ResData[1]	2520 Low Byte	Inverter status
R_ResData[2]	2520 High Byte	
R_ResData[3]	2521 Low Byte	Error description
R_ResData[4]	2521 High Byte	
R_ResData[5]	2522 Low Byte	DI status
R_ResData[6]	2522 High Byte	
R_ResData[7]	2523 Low Byte	Frequency command
R_ResData[8]	2523 High Byte	
R_ResData[9]	2524 Low Byte	Output frequency
R_ResData[10]	2524 High Byte	

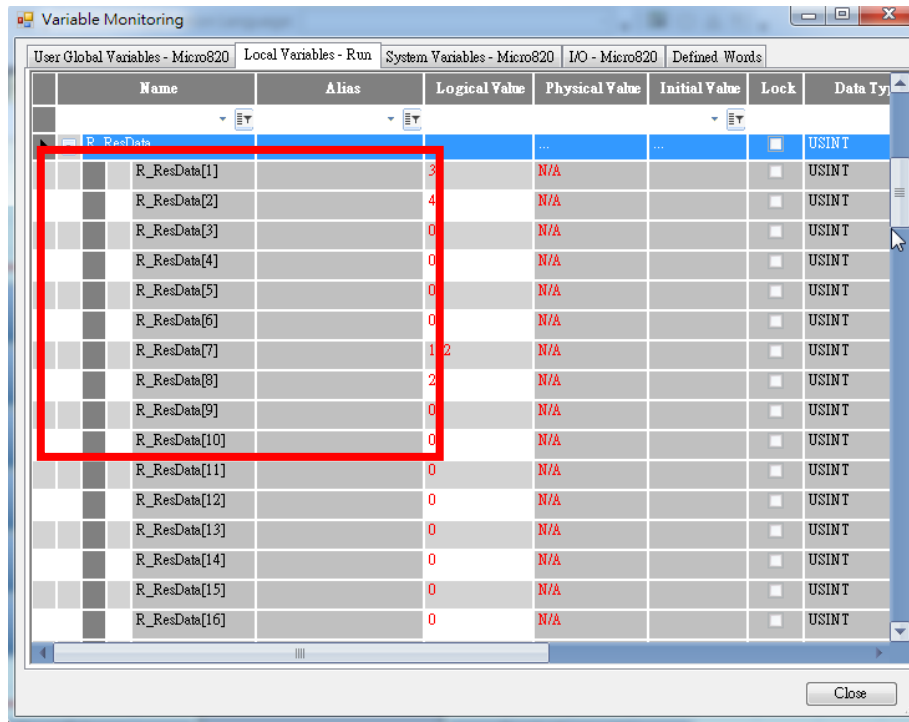

Execute Molex Ethernet/IP Tool and send the UCMM read command (Get Attribute) to the 510 communication module (Ethernet/IP); the response that can be received from the communication module is as shown in the figure below.

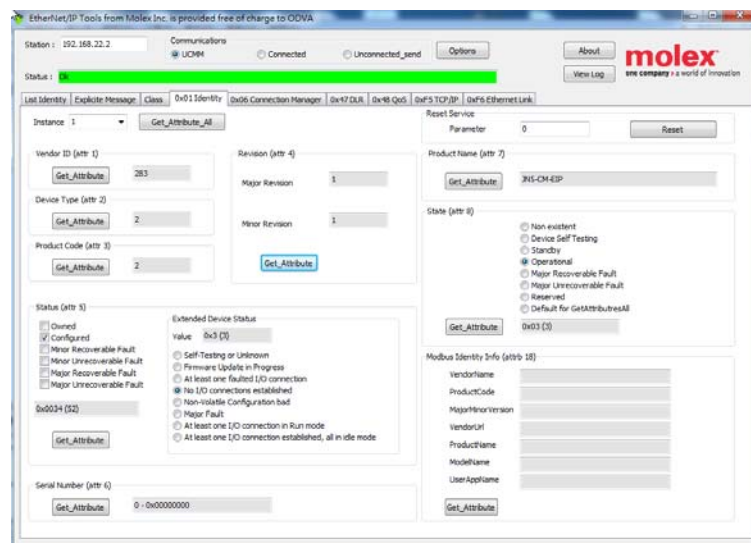

Class	Instance	Attribute	Name	Default	R/W	Size
0x01	1	1	Vendor ID	283	R	U32
0x01	1	2	Device Type	2	R	U32
0x01	1	3	Product code	2	R	U32
0x01	1	4	Major Revision	1	R	U32
0x01	1	5	Minor Revision	1	R	U32

The run command sent to the inverter written with the PLC command is as follows

Commands can be sent to the inverter through PLC from the following switch A\_ReqData[1] inverter operation signal (2501H)

PLC command address	Function	Description
A_ReqData[1].0	Operation status	1 : RUN 0 : STOP
A_ReqData[1].1	Direction status	1 : REV 0 : FWD
A_ReqData[1].2	External error	1:EF0
A_ReqData[1].3	Error reset	1 : RESET

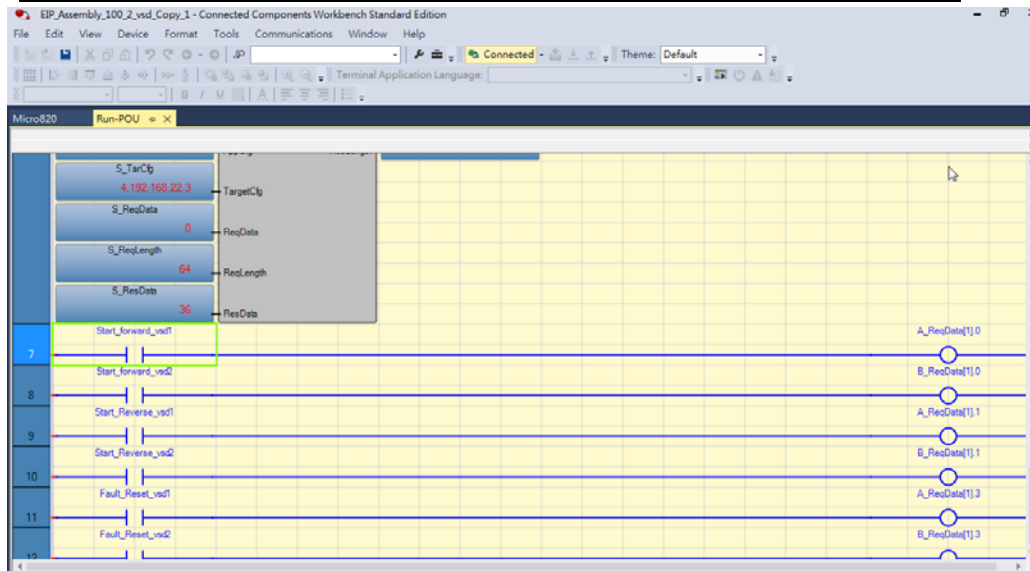

The run command sent to the inverter written with the Molex Ethernet/IP Tool is as follows

Service Code No.	Service Name
0E(HEX)	Get Attribute Single
10(HEX)	Set Attribute Single

Class(HEX)	2A	29	29
Instance(HEX)	1	1	1
Attribute(HEX)	8	3	4
Write data(HEX)	0~70 17	0~1	0~1
Corresponding command	SPEED REFERENCE	1:RUN FORWARD 0: STOP	1:REVERSE RUN 0: STOP
Inverter action	Panel frequency 60Hz	Forward rotation	Reversed rotation



## 11.18 Bluetooth LCD KEYPAD (JN5-OP-BTH)

### 11.18.1 Preparations before using the instrument

- For A510s Enhanced & F510 Enhanced series inverter (C/B requires burning of Bluetooth LCD operator communication protocol)\*1
- Bluetooth communication device (IOS system mobile phone or Android system mobile phone) \*1
- TECO “BT DriveLink” APP (Download from Apple APP Store or Google Play)

### 11.18.2 Connecting the Bluetooth APP with the motor drive Bluetooth LCD operator

- Motor drive setting

In order to ensure operational safety, the Bluetooth communication function is disabled by default; to enable the Bluetooth communication function, please set the motor drive to “09-11 = 1 (On).” When the power is disconnected after that, Bluetooth communication mode can be selected for the motor drive. Press the **LOC/REM** button at the top-left to execute Bluetooth connection; when the following Bluetooth screen appears, Bluetooth APP connection can be used, as shown in the figure below:



To cancel Bluetooth communication, press the **LOC/REM** button at the top-left again to switch to the parameter page to perform operations to disable the Bluetooth function.

- APP setting

Open the following APP (**BLE DriveLink**) from the Bluetooth communication device (IOS or Android mobile phone).



After executing the APP, the APP login screen will appear (as shown in the bottom-left figure); use the default account and password to log into the system.

Default test account: [demo@test.com](mailto:demo@test.com) Default password: 888888

The system will display as the bottom-right figure; perform selection according to the tester series.

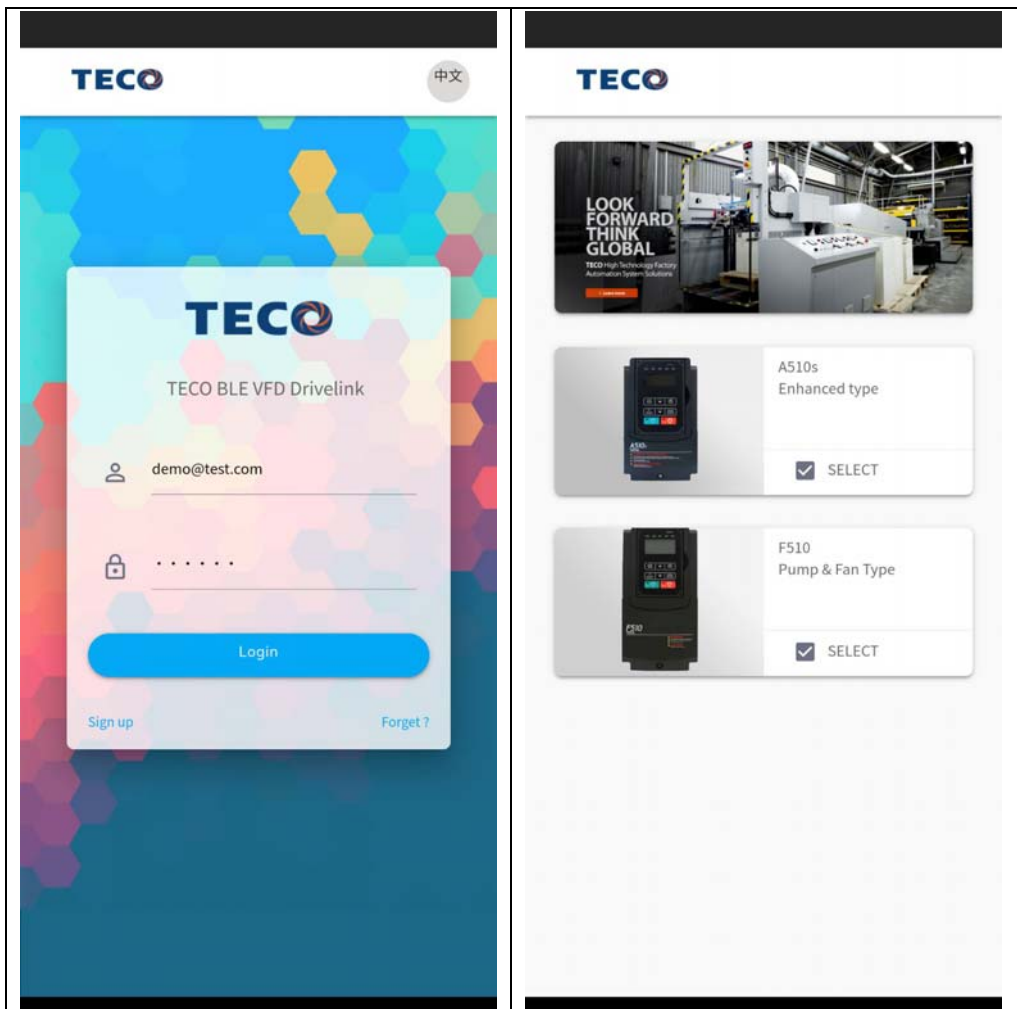

- Bluetooth connection setting process description

The Bluetooth icon at the top-right will be displayed in gray before it's connected (as

shown in the bottom-left figure).

After pressing this icon and then selecting **Bluetooth Status**, a screen matching the bottom-right figure will appear.

Press **Bluetooth Scan** on the screen in the right figure and **TECO-BLE XX** will appear (Note), confirming the device is online.

After confirming the device to connect, press the device name at the center to start connecting.

(Note) The last two digits of TECO-BLE XX is displayed according to the communication station parameter 09-00.

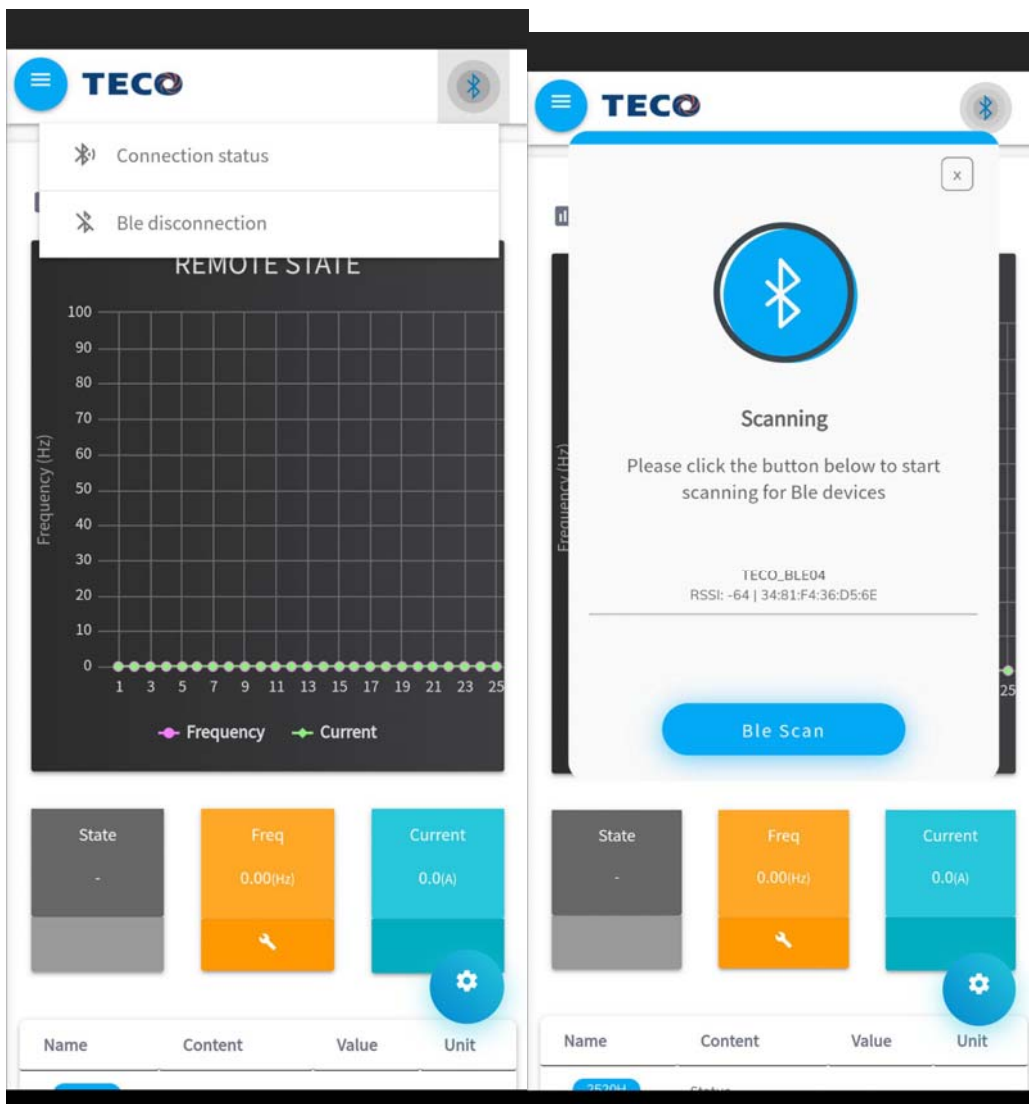

Once the Bluetooth connection is successfully established, a prompt window as shown in the bottom-left figure will appear, meaning successfully connected.

After pressing OK, scroll down the page and it can be seen that the value behind the parameter 2520H has started showing related communication data, meaning that the communication connection is successful.

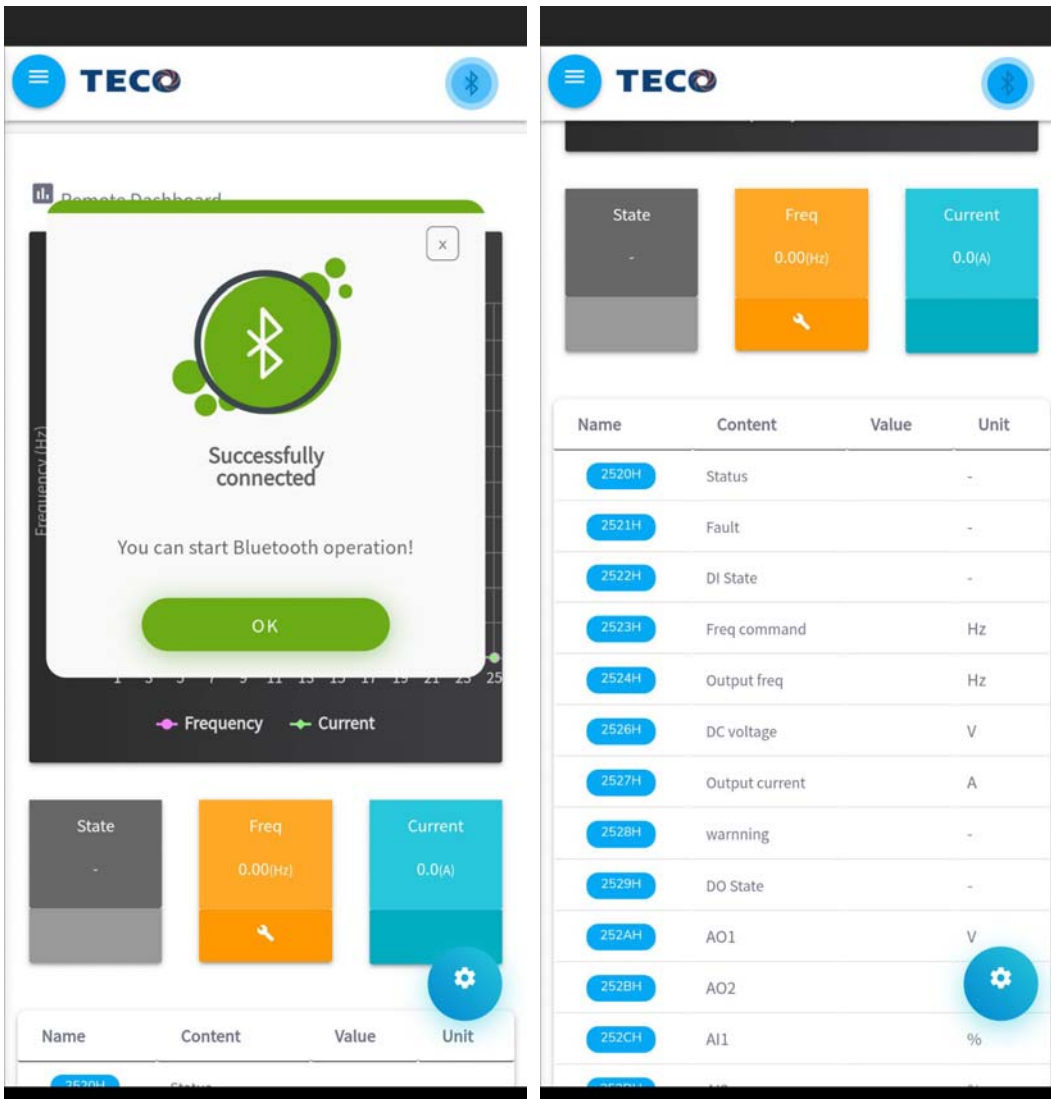

- Descriptions of basic APP functions
  - Introduction to the interface

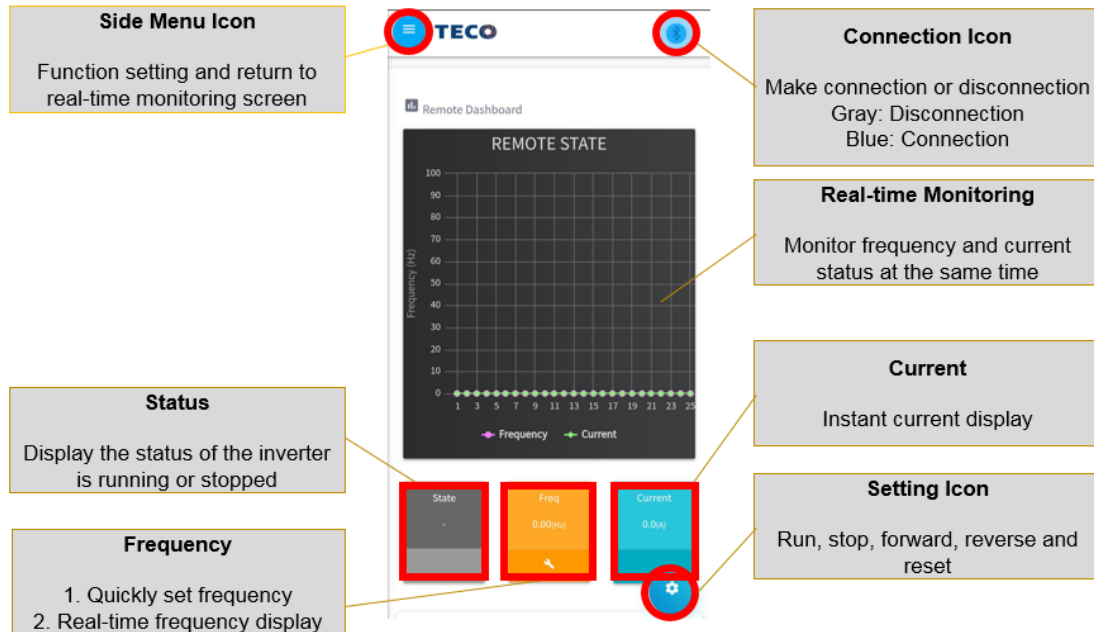

※ **Setting icon:**

To use Bluetooth to control the operation of the motor drive, the **Main operation control command 00-02** parameter must be set as 2 (communication control). Press the “Setting icon” button and the control icons of the motor control will appear, including five motor drive operation control commands: Run / Stop / Forward / Reverse / Reset. At this time, press **Run** **Stop** to perform operation control actions for the motor drive.

■ **Parameter settings function**

Press the ☰ symbol at the top-left of the APP and then press **Parameter settings**, and functions that can be selected and set include **General parameter settings**, **IM autotuning function** settings, and **PM autotuning function** settings.

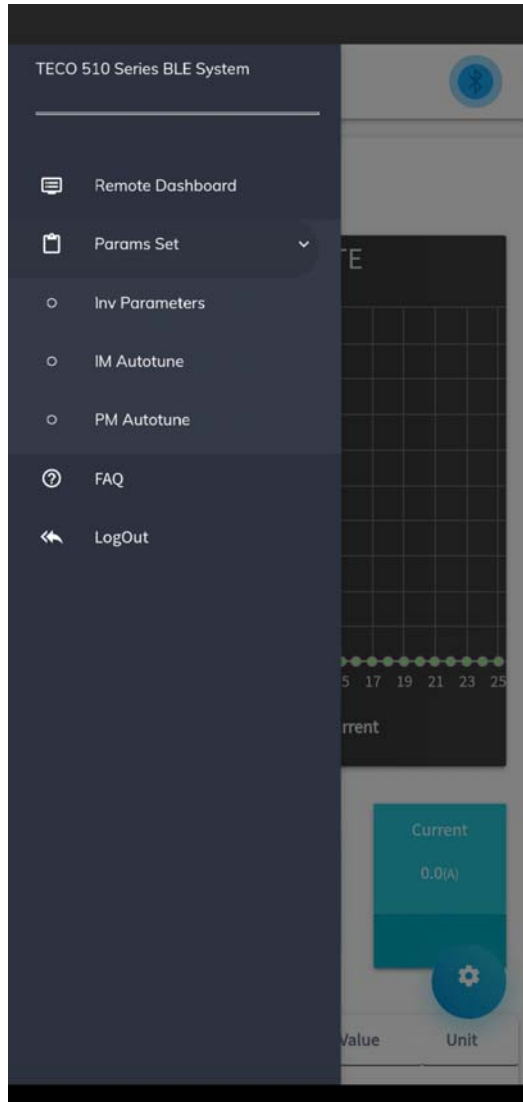

## ■ **General parameter settings**

Parameter settings can be performed directly, and be written into the connected machine.

Select the modified parameters or select all, and **Write into the group** to complete parameter settings.

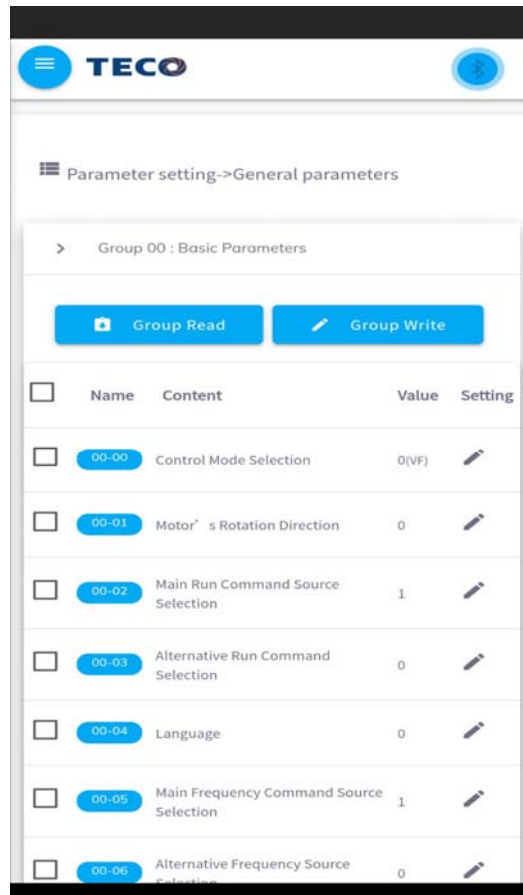

## ■ **IM autotuning function settings**

After setting the various motor parameters, the induction motor autotuning function can be executed. When the autotuning is completed, autotuning failed (Note) or autotuning successful will be displayed.

Press the symbol at the top-left of the APP when completed and press **Real-time monitoring** to return to the monitoring screen and execute functions such as Run and Stop etc.

Note: Please confirm whether there are errors with the parameter settings; refer to the explanations in the manual.

#### ■ **PM autotuning function setting**

After setting the various motor parameters, the permanent-magnet motor autotuning function can be executed. When the autotuning is completed, autotuning failed (Note) or autotuning successful will be displayed.

Press the  symbol at the top-left of the APP when completed and press **Real-time monitoring** to return to the monitoring screen and execute functions such as Run and Stop etc.

Note: Please confirm whether there are errors with the parameter settings; refer to the explanations in the manual.

#### FCC WARNING STATEMENT

This device complies with Part 15 of the FCC Rules. Operation is subject to the following two conditions: (1) this device may not cause harmful interference, and (2) this device must accept any interference received, including interference that may cause undesired operation.

#### IC WARNING STATEMENT

Canada, Industry Canada (IC) Notices

This Class B digital apparatus complies with Canadian ICES-003 and RSS-247. Operation is subject to the following two conditions: (1) this device may not cause interference, and (2) this device must accept any interference, including interference that may cause undesired operation of the device.

Radio Frequency (RF) Exposure Information

The radiated output power of the Wireless Device is below the Industry Canada (IC) radio frequency exposure limits. The Wireless Device should be used in such a manner such that the potential for human contact during normal operation is minimized.

This device has also been evaluated and shown compliant with the IC RF Exposure limits under mobile exposure conditions (antennas are greater than 20cm from a person's body).



# Appendix A: Communication Networks

## A1.1 RS485 –Network (Modbus)

This section shows a RS485 network consisting of several inverters communicating using the built-in Modbus RTU protocol.

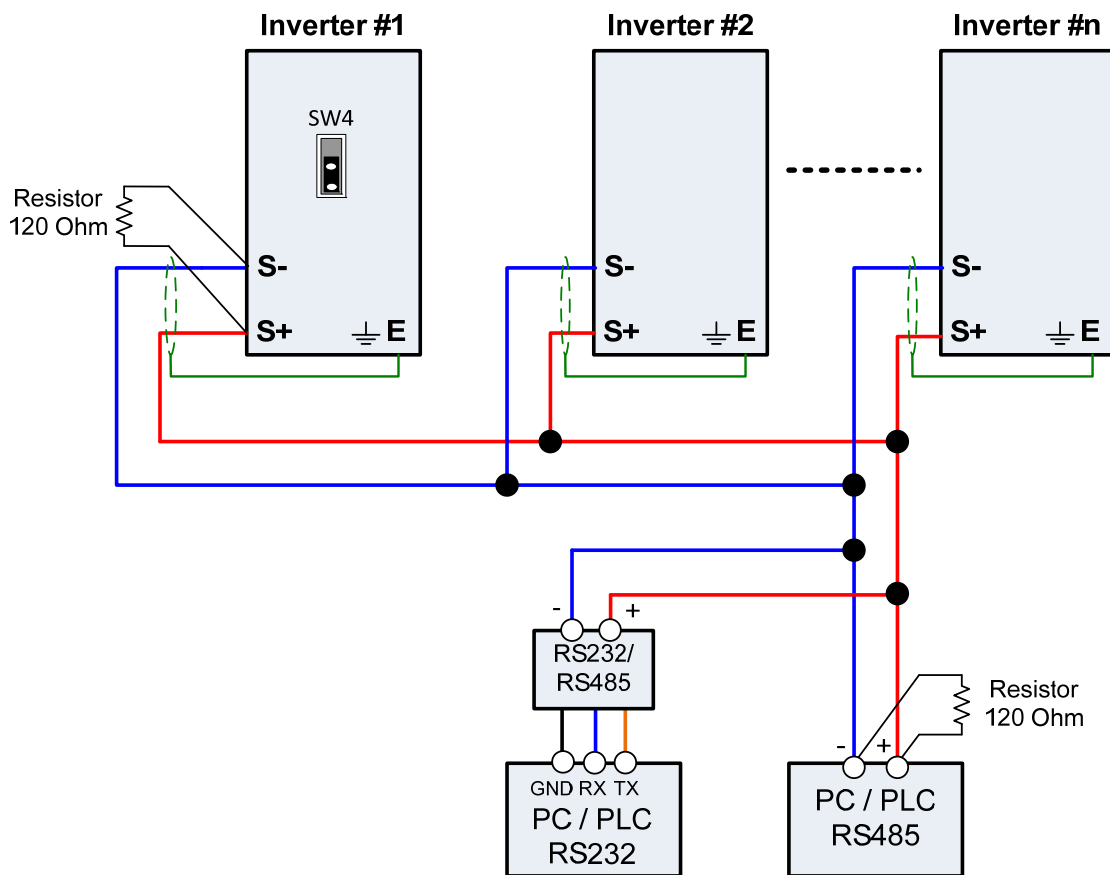

Wiring diagram RS485 Modbus RTU Network

### Notes:

- A PC / PLC controller with a built-in RS-485 interface can be connected directly to the RS-485 network. Use a RS232 to RS485 converter to connect a PC / PLC with a built-in RS-232 interface.
- A maximum of 31 inverters can be connected to the network. Terminating resistors of 120 ohm must be installed at both end of the network.

Refer to A510s RS-485 Modbus communication manual for more information.

## Appendix B: UL Instructions

### Danger

#### Electric Shock Hazard

Do not connect or disconnect wiring while the power is on.  
Failure to comply will result in death or serious injury.

### Warning

#### Electric Shock Hazard

**Do not operate equipment with covers removed.**

Failure to comply could result in death or serious injury.

The diagrams in this section may show inverters without covers or safety shields to show details. Be sure to reinstall covers or shields before operating the inverters and run the inverters according to the instructions described in this manual.

**Always ground the motor-side grounding terminal.**

Improper equipment grounding could result in death or serious injury by contacting the motor case.

**Do not touch any terminals before the capacitors have fully discharged.**

Failure to comply could result in death or serious injury.

Before wiring terminals, disconnect all power to the equipment. The internal capacitor remains charged even after the power supply is turned off. After shutting off the power, wait for at least the amount of time specified on the inverter before touching any components.

**Do not allow unqualified personnel to perform work on the inverter.**

Failure to comply could result in death or serious injury.

Installation, maintenance, inspection, and servicing must be performed only by authorized personnel familiar with installation, adjustment, and maintenance of inverters.

**Do not perform work on the inverter while wearing loose clothing, jewelry, or lack of eye protection.**

Failure to comply could result in death or serious injury.

Remove all metal objects such as watches and rings, secure loose clothing, and wear eye protection before beginning work on the inverter.

**Do not remove covers or touch circuit boards while the power is on.**

Failure to comply could result in death or serious injury.

## Warning

### Fire Hazard

**Tighten all terminal screws to the specified tightening torque.**

Loose electrical connections could result in death or serious injury by fire due to overheating of electrical connections.

**Do not use an improper voltage source.**

Failure to comply could result in death or serious injury by fire.

Verify that the rated voltage of the inverter matches the voltage of the incoming power supply before applying power.

**Do not use improper combustible materials.**

Failure to comply could result in death or serious injury by fire. Attach the inverter to metal or other noncombustible material.

## NOTICE

**Observe proper electrostatic discharge procedures (ESD) when handling the inverter and circuit boards.**

Failure to comply may result in ESD damage to the inverter circuitry.

**Never connect or disconnect the motor from the inverter while the inverter is outputting voltage.**

Improper equipment sequencing could result in damage to the inverter.

**Do not use unshielded cable for control wiring.**

Failure to comply may cause electrical interference resulting in poor system performance. Use shielded twisted-pair wires and ground the shield to the ground terminal of the inverter.

**Do not modify the inverter circuitry.**

Failure to comply could result in damage to the inverter and will void warranty. Teco is not responsible for any modification of the product made by the user. This product must not be modified.

**Check all the wiring to ensure that all connections are correct after installing the inverter and connecting any other devices.**

Failure to comply could result in damage to the inverter.

#### ❖ **UL Standards**

The UL/cUL mark applies to products in the United States and Canada and it means that UL has performed product testing and evaluation and determined that their stringent standards for product safety have been met. For a product to receive UL certification, all components inside that product must also receive UL certification.



#### ❖ **UL Standards Compliance**

This inverter is tested in accordance with UL standard UL508C and complies with UL requirements. To ensure continued compliance when using this inverter in combination with other equipment, meet the following conditions:

##### ■ **Installation Area**

Do not install the inverter to an area greater than pollution severity 2 (UL standard).

## ■ Main Circuit Terminal Wiring

UL approval requires crimp terminals when wiring the inverter's main circuit terminals. Use crimping tools as specified by the crimp terminal manufacturer. Teco recommends crimp terminals made by NICHIFU for the insulation cap.

The table below matches inverter models with crimp terminals and insulation caps.

Closed-Loop Crimp Terminal Size

Drive Model A510s	Wire Gauge mm <sup>2</sup> , (AWG / MCM)		Terminal	Crimp Terminal	Tool	Insulation Cap
	R/L1 • S/L2 • T/L3	U/T1 • V/T2 • W/T3	Screws	Model No.	Machine No.	Model No.
2001	2 (14) / 3.5 (12) / 5.3 (10)		M4	R2-4/R3.5-4/R5.5-4	Nichifu NH 1 / 9	TIC 2/ 3.5/ 5.5
2002	2 (14) / 3.5 (12) / 5.3 (10)		M4	R2-4/R3.5-4/R5.5-4	Nichifu NH 1 / 9	TIC 2/ 3.5/ 5.5
2003	3.5 (12) / 5.3 (10)		M4	R3.5-4 / R5.5-4	Nichifu NH 1 / 9	TIC 3.5/ 5.5
2005	5.3 (10)		M4	R5.5-4	Nichifu NH 1 / 9	TIC 5.5
2008	8.4 (8)		M4	R8-4	Nichifu NOP 60 ; NH 1 / 9	TIC 8
2010	8.4 (8)		M6	R8-6	Nichifu NOP 60 ; NH 1 / 9	TIC 8
2015	13.3 (6)		M6	R14-6	Nichifu NOP 60 / 150HA	TIC 14
2020	21.2 (4)		M6	R22-6	Nichifu NOP 60 / 150HA	TIC 22
2025	21.2 (4)		M6	R22-6	Nichifu NOP 60 / 150HA	TIC 22
2030	33.6 (2)		M8	R38-8	Nichifu NOP 60 / 150HA	TIC 38
2040	67.4 (1/0)		M8	R60-8	Nichifu NOP 60 / 150HA	TIC 60
2060	107.2 (4/0)		M10	R100-10	Nichifu NOP 150HA	TIC 100
2075	152 (300MCM)		M10	R150-10	Nichifu NOP 150HA	TIC 150
2100	200 (400MCM)		M10	R200-10	Nichifu NOP 700 & NOH300K	TIC 200
2125	300 (600MCM)		M12	R325-12S	Nichifu NOP 700 & NOH300K	TIC 325
2150	250 (500MCM) * 2		M12	R250-12	Nichifu NOP 700 & NOH300K	TIC 250
4001	2 (14) / 3.5 (12) / 5.3 (10)		M4	R2-4/R3.5-4/R5.5-4	Nichifu NH 1 / 9	TIC 2/ 3.5/ 5.5
4002	2 (14) / 3.5 (12) / 5.3 (10)		M4	R2-4/R3.5-4/R5.5-4	Nichifu NH 1 / 9	TIC 2/ 3.5/ 5.5
4003	2 (14) / 3.5 (12) / 5.3 (10)		M4	R2-4/R3.5-4/R5.5-4	Nichifu NH 1 / 9	TIC 2/ 3.5/ 5.5
4005	2 (14) / 3.5 (12) / 5.3 (10)		M4	R2-4/R3.5-4/R5.5-4	Nichifu NH 1 / 9	TIC 2/ 3.5/ 5.5
4008	3.5 (12) / 5.3 (10)		M4	R3.5-4 / R5.5-4	Nichifu NH 1 / 9	TIC 3.5/ 5.5
4010	3.5 (12) / 5.3 (10)		M4	R3.5-4 / R5.5-4	Nichifu NH 1 / 9	TIC 3.5/ 5.5
4015	8.4 (8)		M6	R8-6	Nichifu NOP 60 ; NH 1 / 9	TIC 8
4020	8.4 (8)		M6	R8-6	Nichifu NOP 60 ; NH 1 / 9	TIC 8
4025	8.4 (8)		M6	R8-6	Nichifu NOP 60 ; NH 1 / 9	TIC 8
4030	13.3 (6)		M6	R14-6	Nichifu NOP 60 / 150HA	TIC 14
4040-B	21.2 (4)		M6	R22-6	Nichifu NOP 60 / 150HA	TIC 22
4040	21.2 (4)		M8	R22-8	Nichifu NOP 60 / 150HA	TIC 22
4050	21.2 (4)		M8	R22-8	Nichifu NOP 60 / 150HA	TIC 22
4060	33.6 (2)		M8	R38-8	Nichifu NOP 60 / 150HA	TIC 38
4075	67.4 (2/0)		M8	R70-8	Nichifu NOP 60 / 150HA	TIC 70
4100	85 (3/0)		M10	R80-10	Nichifu NOP 60 / 150HA	TIC 80
4125	152 (300MCM)		M10	R100-10	Nichifu NOP 60 / 150HA	TIC 100
4150	152 (300MCM)		M10	R150-10	Nichifu NOP 700 & NOH300K	TIC 150
4175	200 (400MCM)		M10	R200-10	Nichifu NOP 700 & NOH300K	TIC 200
4215	250 (500MCM)		M10	R250-10	Nichifu NOP 700 & NOH300K	TIC 250
4270	300 (600MCM)		M12	R325-12S	Nichifu NOP 700 & NOH300K	TIC 325
4300	250 (500MCM) * 2		M12	R250-12	Nichifu NOP 700 & NOH300K	TIC 250
4375	250 (500MCM) * 2		M12	R250-12	Nichifu NOP 700 & NOH300K	TIC 250
4425	250 (500MCM) * 2		M12	R250-12	Nichifu NOP 700 & NOH300K	TIC 250

Drive Model A510s	Wire Gauge mm <sup>2</sup> , (AWG / MCM)		Terminal	Crimp Terminal	Tool	Insulation Cap
	R/L1 • S/L2 • T/L3	U/T1 • V/T2 • W/T3	Screws	Model No.	Machine No.	Model No.
5001	2 (14) / 3.5 (12) / 5.3 (10)		M4	R2-4 ~ R5.5-4	Nichifu NH 1 / 9	TIC 2/ 3.5/ 5.5
5002	2 (14) / 3.5 (12) / 5.3 (10)		M4	R2-4 ~ R5.5-4	Nichifu NH 1 / 9	TIC 2/ 3.5/ 5.5
5003	2 (14) / 3.5 (12) / 5.3 (10)		M4	R2-4 ~ R5.5-4	Nichifu NH 1 / 9	TIC 2/ 3.5/ 5.5
5005	2 (14) / 3.5 (12) / 5.3 (10)		M6	R2-6 ~ R5.5-6	Nichifu NH 1 / 9	TIC 2/ 3.5/ 5.5
5008	3.5 (12) / 5.3 (10)		M6	R3.5-6 / R5.5-6	Nichifu NH 1 / 9	TIC 3.5/ 5.5
5010	3.5 (12) / 5.3 (10)		M6	R3.5-6 / R5.5-6	Nichifu NH 1 / 9	TIC 3.5/ 5.5
6015	5.3 (10)		M6	R5.5-6	Nichifu NH 1 / 9	TIC 5.5
6020	8.4 (8)		M6	R8-6	Nichifu NOP 60 ; NH 1 / 9	TIC 8
6025	8.4 (8)		M6	R8-6	Nichifu NOP 60 ; NH 1 / 9	TIC 8
6030	8.4 (8)		M6	R8-6	Nichifu NOP 60 ; NH 1 / 9	TIC 8
6040	8.4 (8)		M6	R8-6	Nichifu NOP 60 ; NH 1 / 9	TIC 8
6050	13.3 (6)		M8	R14-8	Nichifu NOP 60 / 150HA	TIC 14
6060	13.3 (6)		M8	R14-8	Nichifu NOP 60 / 150HA	TIC 14
6075	21.2 (4)		M8	R22-8	Nichifu NOP 60 / 150HA	TIC 22
6100	33.6 (2)		M10	R38-10	Nichifu NOP 60 / 150HA	TIC 38
6125	67.4 (2/0)		M10	R70-10	Nichifu NOP 60 / 150HA	TIC 70
6150	67.4 (2/0)		M10	R70-10	Nichifu NOP 60 / 150HA	TIC 70
6175	85 (3/0)		M10	R80-10	Nichifu NOP 60 / 150HA	TIC 80
6215	152 (300MCM)		M10	R150-10	Nichifu NOP 700 & NOH300K	TIC 150
6250	152 (300MCM)		M10	R150-10	Nichifu NOP 700 & NOH300K	TIC 150
6270	152 (300MCM)		M10	R150-10	Nichifu NOP 700 & NOH300K	TIC 150

Drive Model A510s (F)	Wire Gauge mm <sup>2</sup> , (AWG / MCM)		Terminal	Crimp Terminal	Tool	Insulation Cap
	R/L1 • S/L2 • T/L3	U/T1 • V/T2 • W/T3	Screws	Model No.	Machine No.	Model No.
4001	2 (14) / 3.5 (12) / 5.3 (10)		M4	R2-4/R3.5-4/R5.5-4	Nichifu NH 1 / 9	TIC 2/ 3.5/ 5.5
4002	2 (14) / 3.5 (12) / 5.3 (10)		M4	R2-4/R3.5-4/R5.5-4	Nichifu NH 1 / 9	TIC 2/ 3.5/ 5.5
4003	2 (14) / 3.5 (12) / 5.3 (10)		M4	R2-4/R3.5-4/R5.5-4	Nichifu NH 1 / 9	TIC 2/ 3.5/ 5.5
4005	2 (14) / 3.5 (12) / 5.3 (10)		M4	R2-4/R3.5-4/R5.5-4	Nichifu NH 1 / 9	TIC 2/ 3.5/ 5.5
4008	5.3 (10)		M4	R5.5-4	Nichifu NH 1 / 9	TIC 5.5
4010	5.3 (10)		M6	R5.5-6	Nichifu NOP 60 ; NH 1 / 9	TIC 5.5
4015	8.4 (8)		M6	R8-6	Nichifu NOP 60 ; NH 1 / 9	TIC 8
4020	8.4 (8)		M6	R8-6	Nichifu NOP 60 ; NH 1 / 9	TIC 8
4025	8.4 (8)		M6	R8-6	Nichifu NOP 60 ; NH 1 / 9	TIC 8
4030	13.3 (6)		M6	R14-6	Nichifu NOP 60 / 150HA	TIC 14
4040-B	21.2 (4)		M6	R22-6	Nichifu NOP 60 / 150HA	TIC 22
4040	21.2 (4)		M8	R22-8	Nichifu NOP 60 / 150HA	TIC 22
4050	21.2 (4)		M8	R22-8	Nichifu NOP 60 / 150HA	TIC 22
4060	33.6 (2)		M8	R38-8	Nichifu NOP 60 / 150HA	TIC 38

❖ **Type 1**

During installation, all conduit hole plugs shall be removed, and all conduit holes shall be used.

Drive Model A510	Fuse Type	
	Manufacturer: Bussmann / FERRAZ SHAWMUT	
	Model	Fuse Ampere Rating (A)
200 V Class Three-Phase Drives		
2001	Bussmann 20CT	690V 20A
2002	Bussmann 30FE	690V 30A
2003	Bussmann 50FE	690V 50A
2005	Bussmann 50FE	690V 50A
2008	Bussmann 63FE	690V 63A
2010	FERRAZ SHAWMUT A50QS100-4	500V 100A
2015	Bussmann 120FEE / FERRAZ A50QS150-4	690V 120A / 500V 150A
2020	FERRAZ SHAWMUT A50QS150-4	500V 150A
2025	FERRAZ SHAWMUT A50QS200-4	500V 200A
2030	FERRAZ SHAWMUT A50QS250-4	500V 250A
2040	FERRAZ SHAWMUT A50QS300-4	500V 300A
2050	FERRAZ SHAWMUT A50QS400-4	500V 400A
2060	FERRAZ SHAWMUT A50QS500-4	500V 500A
2075	FERRAZ SHAWMUT A50QS600-4	500V 600A
2100	FERRAZ SHAWMUT A50QS700-4	500V 700A

Drive Model A510	Fuse Type	
	Manufacturer: Bussmann / FERRAZ SHAWMUT	
	Model	Fuse Ampere Rating (A)
400 V Class Three-Phase Drives		
4001	Bussmann 10CT	690V 10A
4002	Bussmann 16CT	690V 16A
4003	Bussmann 16CT	690V 16A
4005	Bussmann 25ET	690V 25A
4008	Bussmann 40FE	690V 40A
4010	Bussmann 50FE	690V 50A
4015	Bussmann 63FE	690V 63A
4020	Bussmann 80FE	690V 80A
4025	Bussmann 100FE / FERRAZ A50QS100-4	690V 100A / 500V 100A
4030	Bussmann 120FEE	690V 120A
4040	FERRAZ SHAWMUT A50QS150-4	500V 150A
4050	FERRAZ SHAWMUT A50QS200-4	500V 200A
4060	FERRAZ SHAWMUT A50QS250-4	500V 250A
4075	FERRAZ SHAWMUT A50QS300-4	500V 300A
4100	FERRAZ SHAWMUT A50QS400-4	500V 400A
4125	FERRAZ SHAWMUT A50QS500-4	500V 500A
4150	FERRAZ SHAWMUT A50QS600-4	500V 600A
4175	FERRAZ SHAWMUT A50QS700-4	500V 700A
4215	FERRAZ SHAWMUT A50QS700-4	500V 700A

❖ **Motor Over-temperature Protection**

Motor over-temperature protection shall be provided in the end use application.

■ **Field Wiring Terminals**

All input and output field wiring terminals not located within the motor circuit shall be marked to indicate the proper connections that are to be made to each terminal and indicate that copper conductors, rated 75°C are to be used.

## ■ Inverter Short-Circuit Rating

This inverter has undergone the UL short-circuit test, which certifies that during a short circuit in the power supply the current flow will not rise above value. Please see electrical ratings for maximum voltage and table below for current.

- The MCCB and breaker protection and fuse ratings (refer to the preceding table) shall be equal to or greater than the short-circuit tolerance of the power supply being used.
- Suitable for use on a circuit capable of delivering not more than (A) RMS symmetrical amperes for DiJ2.IHp in 240 / 480 V class drives motor overload protection.

Horse Power ( Hp )	Current ( A )	Voltage ( V )
1 - 50	5,000	240 / 480
51 - 200	10,000	240 / 480
201 - 400	18,000	240 / 480
401 - 600	30,000	240 / 480

## ❖ Inverter Motor Overload Protection

Set parameter 02-0 I (motor rated current) to the appropriate value to enable motor overload protection. The internal motor overload protection is UL listed and in accordance with the NEC and CEC.

## ■ 02-01 Motor Rated Current

Setting Range Model Dependent  
Factory Default: Model Dependent

The motor rated current parameter (02-0) protects the motor and allows for proper vector control when using open loop vector or flux vector control methods (00-00 = 2 or 3). The motor protection parameter 08-05 is set as factory default. Set 02-01 to the full load amps (FLA) stamped on the nameplate of the motor. The operator must enter the rated current of the motor (17-02) in the menu during auto-tuning. If the auto-tuning operation completes successfully (17-00 = 0), the value entered into 17-02 will automatically write into 02-0 I.



■ **08-05 Motor Overload Protection Selection**

The inverter has an electronic overload protection function (OL1) based on time, output current, and output frequency, which protects the motor from overheating. The electronic thermal overload function is UL-recognized, so it does not require an external thermal overload relay for single motor operation. This parameter selects the motor overload curve used according to the type of motor applied.

08-05	Selection for motor overload protection (OL1)
Range	<p><b>xxx0b:</b> Motor overload is invalid  <b>xxx1b:</b> Motor overload is valid  <b>xx0xb:</b> Cold start of motor overload  <b>xx1xb:</b> Hot start of motor overload  <b>x0xxb:</b> Standard motor  <b>x1xxb:</b> Special motor  <b>0xxxb:</b> Reserved  <b>1xxxb:</b> Reserved</p>

Sets the motor overload protection function in 08-05 according to the applicable motor.

**08-05 = ---OB:** Disables the motor overload protection function when two or more motors are connected to a single inverter. Use an alternative method to provide separate overload protection for each motor such as connecting a thermal overload relay to the power line of each motor.

**08-05 = --1-B:** The motor overload protection function should be set to hot start protection characteristic curve when the power supply is turned on and off frequently, because the thermal values are reset each time when the power is turned off.

**08-05 = -0—B:** For motors without a forced cooling fan (general purpose standard motor), the heat dissipation capability is lower when in low speed operation.

**08-05 = -1—B:** For motors with a forced cooling fan (inverter duty or VIF motor), the heat dissipation capability is not dependent upon the rotating speed.

To protect the motor from overload by using electronic overload protection, be sure to set parameter 02-01 according to the rated current value shown on the motor nameplate.

Refer to the following "Motor Overload Protection Time" for the standard motor overload protection curve example: Setting 08-05 = -0--B.

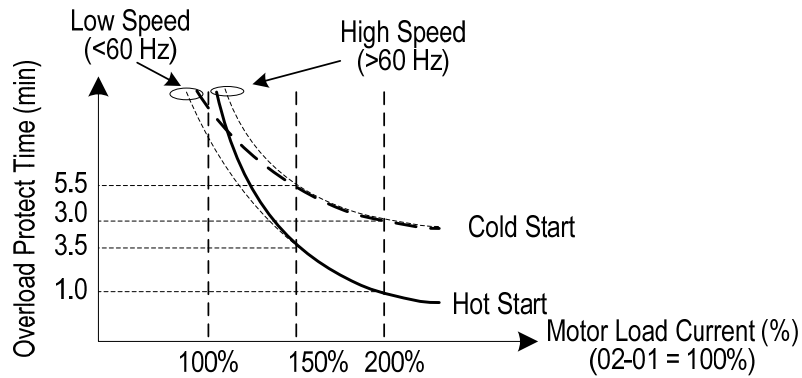

■ **08-06 Motor Overload Operation Selection**

<b>08-06</b>	<b>Start-up mode of overload protection operation (OL1)</b>
<b>Range</b>	<b>0:</b> Stop output after overload protection <b>1:</b> Continuous operation after overload protection.

**08-06=0:** When the inverter detects a motor overload the inverter output is turned off and the OL1 fault message will flash on the keypad. Press RESET button on the keypad or activate the reset function through the multi-function inputs to reset the OL1 fault.

**08-06=1:** When the inverter detects a motor overload the inverter will continue running and the OL1 alarm message will flash on the keypad until the motor current falls within the normal operating range.

**UL- Additional Data**

**Recommended Input Fuse Selection**

Drive Model A510	Fuse Type	
	Manufacturer: Bussmann / FERRAZ SHAWMUT	
	Model	Fuse Ampere Rating (A)
200 V Class Three-Phase Drives		
2125	Bussmann 170M5464	690V 800A
2150	Bussmann 170M5464	690V 800A

Drive Model A510	Fuse Type	
	Manufacturer: Bussmann / FERRAZ SHAWMUT	
	Model	Fuse Ampere Rating (A)
400 V Class Three-Phase Drives		
4250	Bussmann 170M5464	690V 800A
4300	Bussmann 170M5464	690V 800A
4375	Bussmann 170M5466	690V 1000A
4425	Bussmann 170M5466	690V 1000A

# INVERTER A510s series

## Safety stop function instruction manual

### CONTENTS

1. Introduction.....	3
2. Safety-Related Standard .....	3
3. Product Information.....	4
4. Safety Stop / Safety Torque OFF .....	5
5. Electromechanical and Safety integrated interface Comparison ..	6
6. Terminal designation & interface.....	7
7. Safety Input logic & Status.....	9
8. Installation and wiring .....	10
9. Safety Input Status.....	11
10. Safety design and specifications .....	13

## Compliance with the EU Machinery Directive – Functional Safety

### WARNING

Safe Torque off function may not be an appropriate method for stopping your machine. Activating this function will result in no output voltage to the Motor hence motor will coast down to stop under the influence of the load inertia.

### WARNING

Any misuse of safety function could lead to personal injury or death, property damage, or economic loss. To ensure that the system complies fully with requirement of safety, make a system-level risk assessment. TECO Electric Co. cannot assume responsibility for any system to comply with safety directive.

### CAUTION

The information of this manual is merely a guide for proper installation. TECO Electric Co. cannot assume responsibility for the compliance or the noncompliance to any code, national, local or otherwise for the proper installation of this equipment. A hazard of personal injury and/or equipment damage exists if codes are ignored during installation.

### WARNING

To avoid an electric shock hazard, verify that the voltage on the bus capacitors has discharged before performing any work on the drive. Measure the DC bus voltage at the P(+) and N(-) terminals or test points (refer to your drive' s User Manual for locations and discharging time). The voltage must be zero.

### WARNING

To avoid an electric shock hazard, disconnect/isolate power to the drive and verify to ensure that the voltage is zero before performing any work on the motor (refer to your drive' s User Manual for discharging time).

### CAUTION

In order to maintain the pollution degree 2 the devices shall be mounted in a cabinet of IP 54 type .or pollution controlled environment.

### CAUTION

Ensure that the external safety relay unit and the A510s drive are mounted close to each other all interconnection wiring is as short as possible and protected against open and short circuit faults. Refer EN/ISO13849-1.

### CAUTION

To avoid systematic faults, a test even for faulty demands of the safety function has to be performed in order to check the correct function of the monitor signal. This test shall be carried out at system installation, any software changes, parameterization changes, and/or at least once per year. Refer to "Chapter 10 Troubleshooting and Fault Diagnostics" .

# 1. Introduction

This document describes the main design specification of the A510s Safe Torque Off (STO) and the requirements for its installation and integration within safety related applications. The correct Installation and integration of the A510s STO is the responsibility of the Installer and it is expected that the installer follows the safety guide and is a trained technician and experienced in the design of safety systems.

**A510s STO (Safe Torque Off) The product circuit and function are designed with reference to the relevant standards:**

- Safety Integrated category SIL2 according to EN/IEC 62061, IEC 61508, EN61800-5-2
- Performance level. Category 3/ Pl(d). According to EN/ISO 13849-1 Stop category 0. According to EN60204-1

## 2. Safety-Related Standard

### 2.1 Directives

IEC/EN 61800- 5-2 : 2007	Adjustable Speed Electrical Power Drive Systems. Part 5-2: Safety Requirements – Functional
EN ISO 13849-1: 2008	Safety of Machinery – Safety-related parts of control systems. Part 1: General Principles for Design
IEC 61508- 1~7	Functional Safety of Electrical/Electronic/Programmable Electronic Safety-related systems
IEC 62061: 2005	Safety of Machinery – Functional safety of safety-related electrical, electronic and programmable electronic control systems
EN 60204-1	Safety of machinery - Electrical equipment of machines. General requirements.

### 2.2 Installation Environment

**A510s safety stop function should only be used under the following condition and environment.**

Item		Condition
Temperature range	Operation	-10°C~50°C inside distributor (without dust cover) -10°C~40°C inside distributor (with dust cover)
	Storage	-20°C to +60°C
Ambient humidity		95%RH maximum (non-condensing)
Shock		1G. (9.8m/s <sup>2</sup> ) for 20Hz and below. 0.6G (5.88m/s <sup>2</sup> ) from 20Hz to 50Hz (Compliance with IEC 60068-2-6)
Altitude		maximum 1000m above sea level
Atmosphere		Indoors (without corrosive gas, flammable gas, oil mist, dust and dirt etc.)

Over voltage category	III or less
Pollution degree	II or less
Mounting	wall mounting / vertical orientation

### 3. Product Information

#### 3.1 Product models & range

- 230V three phase. IP20 0.75 ~ 110KW (1 ~ 150Hp) without built-in filter
- 400V three phase. IP20 0.75 ~ 45KW (1 ~ 60Hp) with built-in filter
- 400V three phase. IP20 0.75 ~ 315KW (1 ~ 425Hp) without built-in filter
- 575V there IP20 0.75 ~ 7.5KW (1 ~ 10Hp) without built-in filter
- 690V there IP20 11 ~ 200KW (15 ~ 270Hp) without built-in filter

\* Please refer to Chapter 3 in the front of the installation manual for detail.

#### 3.2 Product Identification

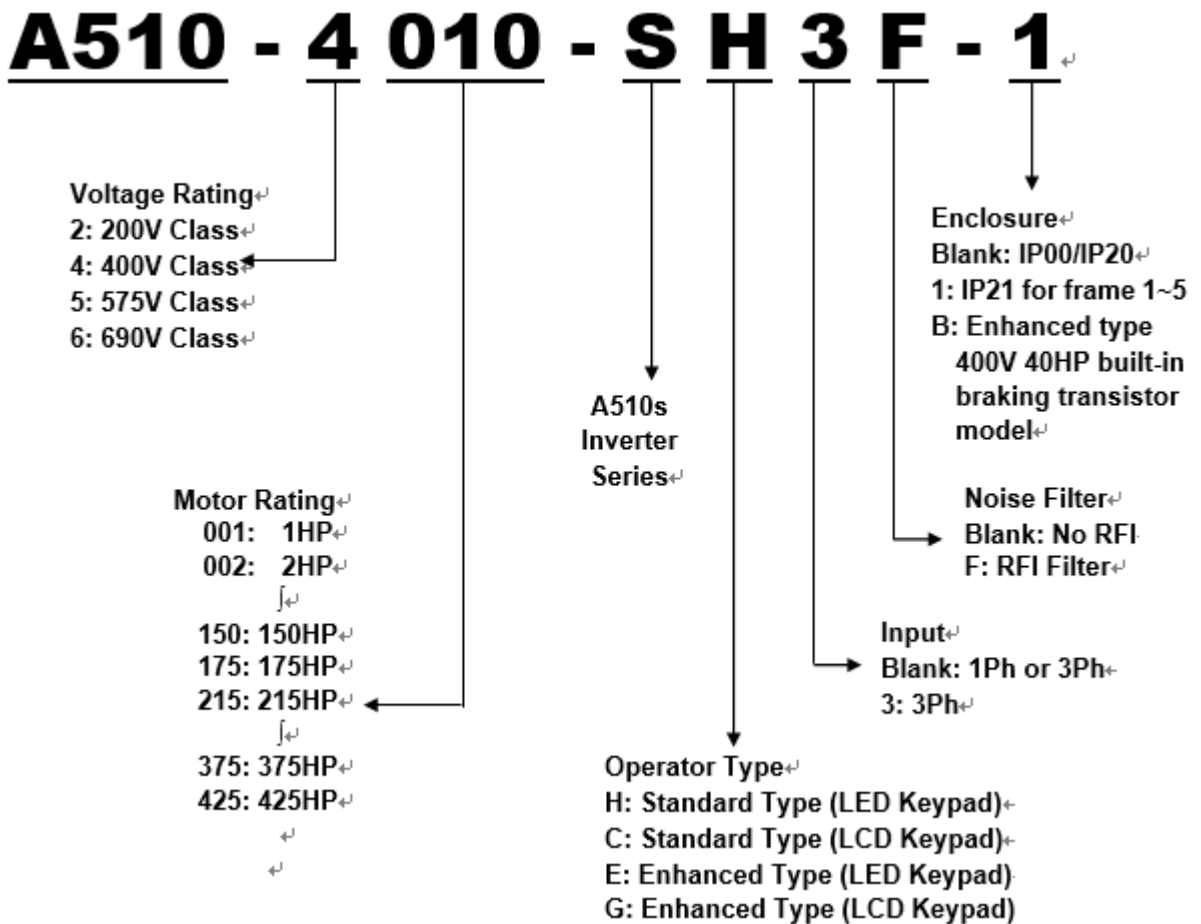

### 3.3 Model Identification

<u>A</u>	<u>B</u>	<u>CDE</u>	<u>F</u>	<u>G</u>	<u>HJ</u>	<u>K</u>	<u>L</u>
A : Product			F : Standard voltage		H-J : O/P Current		
1 : Inverter			1 : 100-120V		04P1 : 4.1 Amp (1HP)		
2 : SERVO			2 : 200-240V		12P1 : 12.1 Amp (5HP)		
3 : PLC			4 : 380-480V		0103 : 103 Amp (60HP)		
B : UL Category			G : Phase		K : Firmware Ver.		
0 : UL Recognized			0 : Single/Three phase		A : A510s		
1 : UL Listed			1 : Single phase		F : F510		
C-E : Serial number			3 : Three phase		L : EMC Filter		
001-999 (202)					blank : Not built-in		
					F : Built-in		

## 4. Safety Stop / Safe Torque Off. (STO).

A510s STO is a functional safety feature that complies with the safety functions in adjustable speed drives according to IEC 61800-5-2 ( type A safety component) and when put in use within a safety control system according to the required safety standards will provide safe Torque off (no output voltage) and Prevents an unintentional restart.

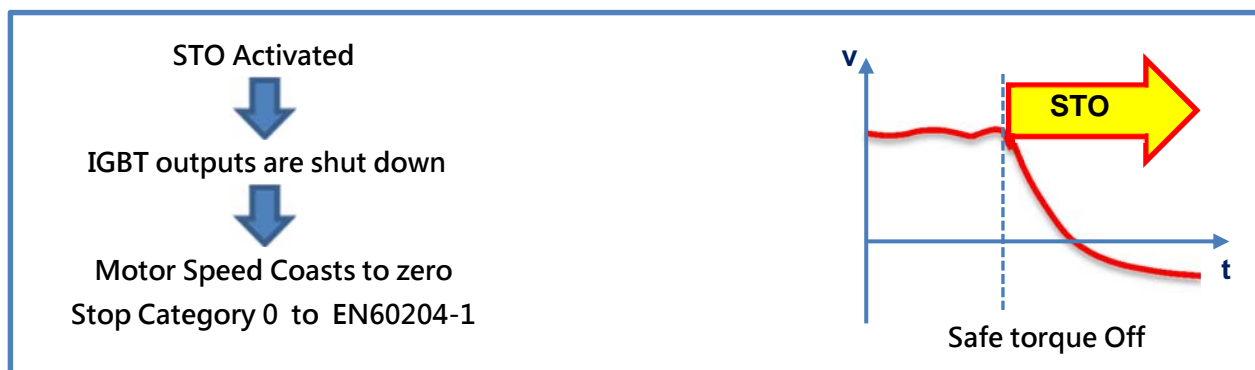

### ⚠ Caution

- The STO Function by itself is not an Emergency Stop and may be used as part of an Emergency Stop control system but all relevant standards must be consulted.
- Decision to use STO in a control system must be based on risk assessment, refer to the relevant standards EN/IEC 62061 or EN/ISO 13849-1.
- In application of STO due to the coast to stop function take into consideration the stopping time of the driven load.
- For further information on STO refer to EN61800-5-2 and For stop categories Refer to EN60204-1

## 5. Electromechanical and Safety integrated interface Comparison

Diagrams below show simple Inverter drive configurations for comparison between safe stop interfaces using electromechanical and Safety integrated type solutions.

**Electromechanical. Without STO function  
No SIL. Stop Category 0**

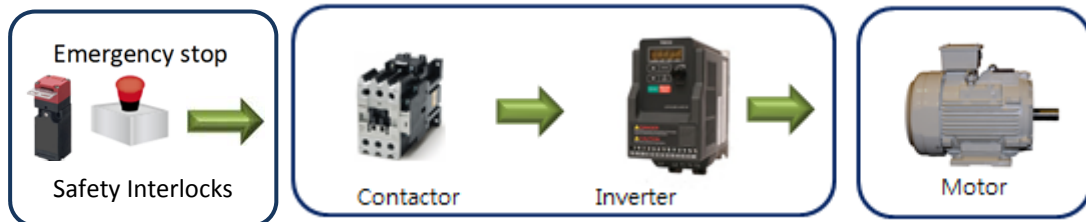

**Electromechanical. Without STO function  
SIL 2. Stop Category 0**

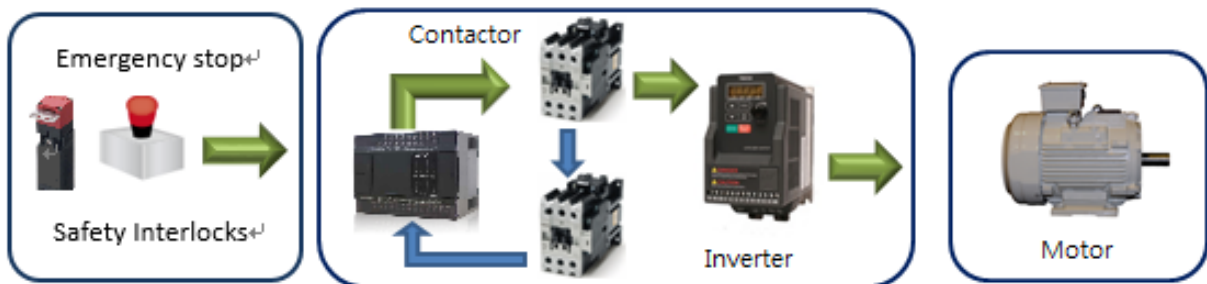

**Integrated STO FUNCTION  
SIL 2. Stop Category 0**





## 6. Terminal designation & interface

### 6.1 Power & Control terminals.

Frame 1. Terminal layout is shown as a typical example.

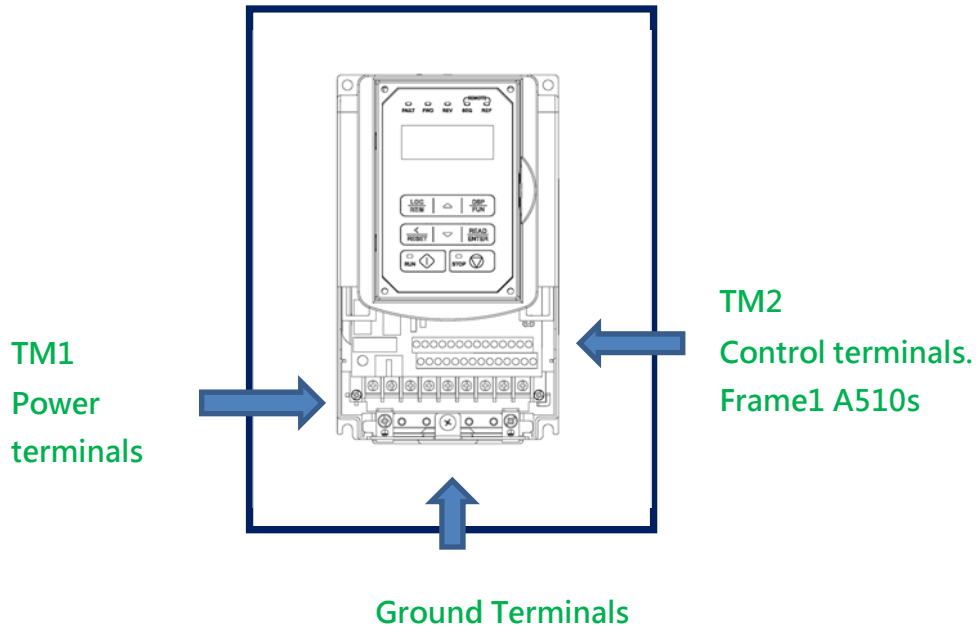

### 6.2 Control terminals & wiring

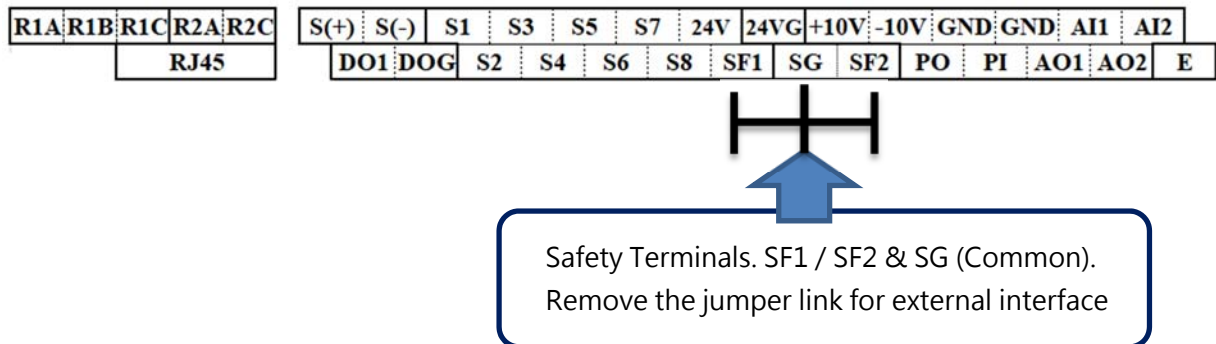
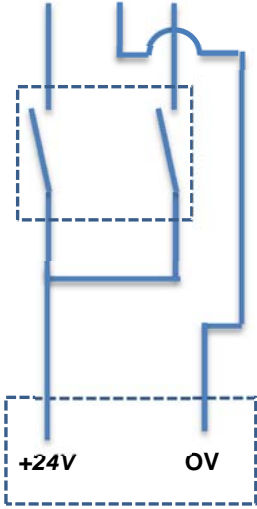

Table 1: Safety related terminals

Terminal Symbol	Description	Rating
SF1	The function status of SF1-SG terminal. Open: In safety stop mode. Short: Non-safety stop mode.	Input resistance : 4.22kΩ Input Current : 5 to 6.5 mA Input Voltage : 21.6 to 26.4 V
SF2	For function status of SF2-SG terminal. Open: In safety stop mode. Short: Non-safety stop mode.	
SG	Common terminal for SF1, SF2 terminals.	

6.3 External 24Vdc supply (Connection option).

R1A	R1B	R1C	R2A	R2C	S(+)	S(-)	S1	S3	S5	S7	24V	24VG	+10V	-10V	GND	GND	AI1	AI2
RJ45					DO1	DOG	S2	S4	S6	S8	SF1	SG	SF2	PO	PI	AO1	AO2	E



*External power Supply*

## 7. Safety Input logic & Status

TECO A510s safety stop function prevents a drive from supplying rotational energy to motors. Dual safety channels "SF1" and "SF2" cut off the gate-drive power for IGBT to turn off. Diagram below shows the basic block diagram design of the safety and interface for the safety inputs.

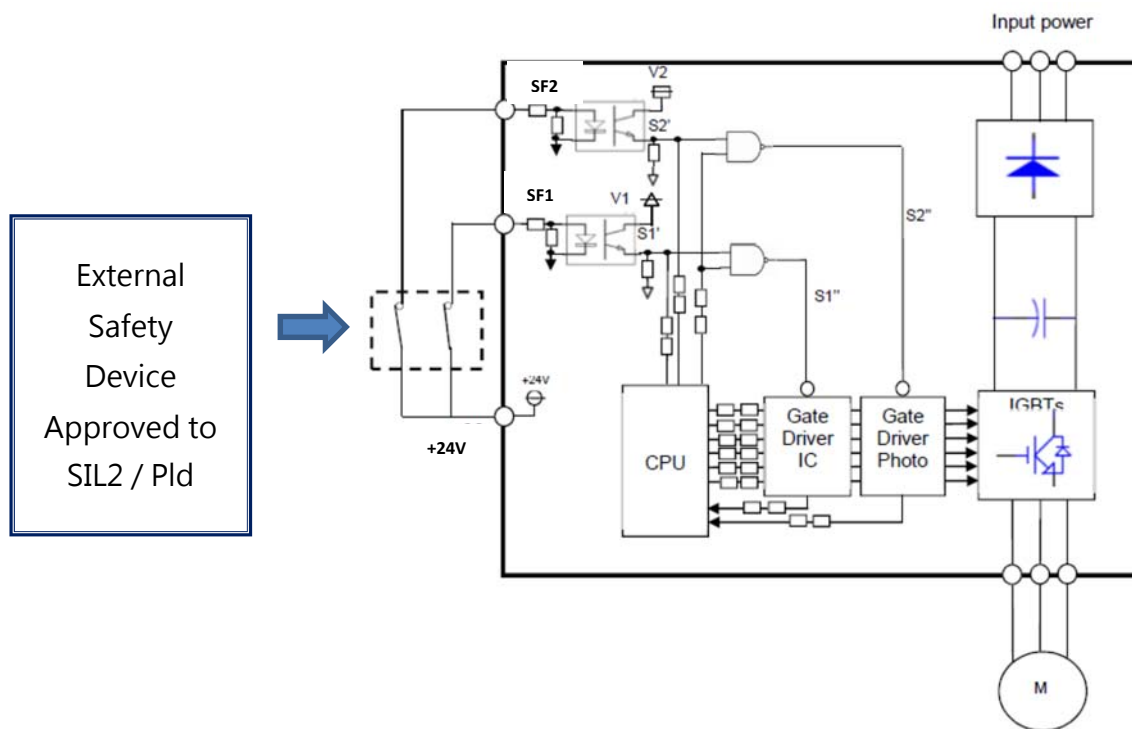

Figure 1: A510s safety stop function diagram

### WARNING

The safety stop function does not isolate electrically between drive and motor. To avoid an electric shock hazard, disconnect/isolate power to the drive and verify to ensure that the voltage is zero before performing any work on the motor (refer to your drive's User Manual for discharging time).

#### Directives

TECO A510s safety stop function refer to the following directives and categories :

- ISO13849-1 : 2008 Category 3/PLd
- IEC62061 : 2005
- IEC61800-5-2 : 2007
- IEC61508 SIL2
- IEC60204-1 : 2006 Stop category 0

### WARNING

The misuse of safety function leads to personal injury or death, property damage, or economic loss. To ensure that the system complies fully with requirement of safety, make a system-level risk assessment. TECO Electric Co. cannot assume responsibility for any system to comply with safety directive.

## 8. Installation and wiring

### CAUTION

The following information is merely a guide for proper installation. TECO Electric & Machinery Co. cannot assume responsibility for the compliance or the noncompliance to any code, national, local or otherwise for the proper installation of this equipment. A hazard of personal injury and/or equipment damage exists if codes are ignored during installation.

### CAUTION

Ensure the safety relay unit and the A510s unit is mounted closely in open type and all interconnection wiring is short and protected against open and short circuit faults. Refer EN/ISO13849-1.

### Installation

TECO A510s safety stop function should be used under following condition and environment.

### CAUTION

In order to meet safety stop, an approved safety relay unit to ISO13849-1 safety category 3. In addition, all other components with in the safety stop loop shall be 'safety approved' types.

### WARNING

To avoid an electric shock hazard, insert the magnetic contactor (MC) between power source and drive. Open the contact of MC and keep away from drive for discharging time (refer to your drive' s *User Manual* for information) before performing any work on the drive. And verify that the voltage on the bus capacitors has discharged before Measure the DC bus voltage at the P(+) and N(-) terminals or test points. (Refer to your drive' s *User Manual* for locations). The voltage must be zero.

### Wiring

The safety related terminals are described in Table 1 & Figure 1.

## 9. Safety Input Status

Table below shows the logic level status for external safety interface, internal circuit and drive output.

Table 2 Truth table of Safety related signals

+24VDC Power supply	External Safety Input Status		Internal safety circuit logic				Safety Circuit Failure	Drive Output Status OFF = Safe State ON= Enabled	Motor status
	SF1-SG	SF2-SG	S1'	S2'	S1''	S2''			
OFF	-	-	-	-	-	-	-	OFF	Stop
ON	OFF	OFF	L	L	H	H	Detected	OFF	Stop
	OFF	ON	L	H	H	L	Detected	OFF	Stop
	ON	OFF	H	L	L	H	Detected	OFF	Stop
	ON	ON	H	H	L	L	-	ON	Run

- The response time from safety stop signal input to drive shutoff is faster than 8ms.
- Hold the ON or OFF status for 1ms or longer to input signal to terminal SF1 or SF2.
- Signal input shorter than 1ms is not recognized.
- About the electric ratings of terminals, please refer to Chapter 3 in the front of the installation manual for detail.

### Diagnostic

Safety stop function protection mechanisms :

Safety stop terminal (SF1-SF2-SG)contact short wire, Disable safety stop mode, Motor running ;

1. When SF1-SG open and SF2-SG short, at this time, protection signal will cut off driver unit enable pin, IGBT none PWM signal, motor free run;
2. Otherwise, When SF1-SG short and SF2-SG open, at this time, protection signal will cut off driver unit input power, IGBT none PWM signal, motor free run;
3. Safety stop terminal (SF1-SF2-SG)contact short wire, the motor running ,When photo-coupler secondary side of the power supply V1 & V2 occurs suddenly OV or UV, CPU detected abnormal voltage state , sent "LO" signal to NAND logic gate cutting off gate drive enable signals, motor free run.

### Self-diagnostic test

A510s does the self-diagnostic test on the power-ON.

If A510s output alarm at power-ON, please take the action described in "Diagnostic" at above.

### **Test procedure for functionality**

As depicted "ATTENTION" in above, the test for the functionality is important. Please do the test following procedure.

- (1) Please make each state of SF1-SG and SF2-SG depicted at Table 2.
- (2) If there is any different state from Table 2, A510s has some malfunction.
- (3) If there is no different state from Table 2, check the systematic performance, such as, press the Emergency switch, press the start/restart button at the failure detected (RUN-SE opened), and so on.
- (4) Finally clear the error record of the A510s (see the user manual how to clear the error record).

## 10. Safety design and specifications

### STO design main requirements

Safety Function Requirement Specification SIL2	
Initiating devices	User connected sensor or other safety devices
Hazard	Rotation of the motor (To be derived from hazard assessment)
Consequence	Human harm or damage to machinery.
Safe State	PWM removed, therefore No Voltage output from the drive.
Required Action	Detect Safe input signals and remove PWM signal.
Response Time	8ms (from STO input signal detection to the final action of STO)
Target SIL	SIL = 2, PL d, category 3
Demand Rate	High demand rate
Mode of Operation	Continuous
PFHD	The PFHD of STO function shall be less than $0.5 \cdot 10^{-6}$
MTBF	The MTBF of drive system shall be more than 100,000 hours
Trip Mode	De-energize to trip
MTTR	No more than 4 hours (No field repair, only change new board)

Parameter	Value
PFD <sub>AVG</sub>	$2.58 \times 10^{-4}$
PFHD	$1.18 \times 10^{-8}$
PL	d
MTBF	8,096 years
DC <sub>AVG</sub>	84%

### Abbreviations:

SIL	Safety Integrated Level
PFHD	Probability of Dangerous failure Per hour
MTBF	Mean Time Between Failures
MTTR	Mean Time to Repair. ( hour)



## Manufacturer's Statement for A510s Enhanced series

A510s Enhanced efficiency according to IEC/EN 61800-9-2

Drive models: A510s Enhanced series, please refer to the table below for the model list

Efficiency class: IE2

Nominal voltage: Please refer to the tabel below

Nominal frequency: 50Hz

Nominal power: Please refer to the tabel below

Motor control: V/f, V/f+PG, SLV, SLV2, SV, PMSV,  
PMSLV

Nominal current: Please refer to the tabel below

Nominal apparent power: Please refer to the tabel below

Maximum operating temperature:

40°C for IP20

50°C for IP00 or top anti-dust cover removed

Frame 5 is 50°C, which is IP20 level

CDM losses and efficiency (calculated with default settings) point: As the picture right

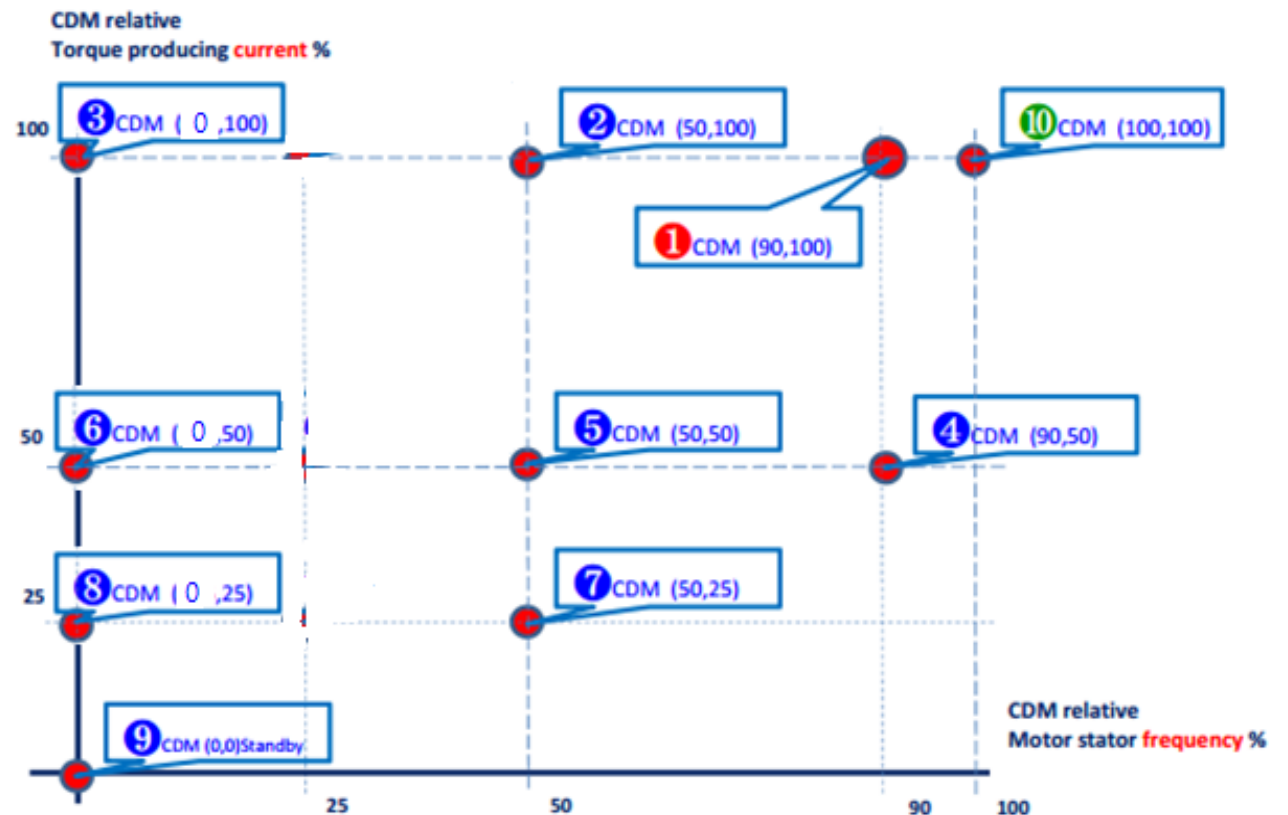

Manufacturer: TECO Electric & Machinery CO., LTD. — 10F, No.3-1, Park St., Nan-Kang, Taipei, 115603, Taiwan

EU contact: MOTOVARIO S.p.A — Via Quattro Passi 1/3 — 41043 — Formigine (MO) — ITALY. MOTOVARIO EORI number: IT02569681204



# CDM losses and efficiency table

Frame	Model Name	Nominal voltage (V)	Nominal current (A)	Nominal power (kW)	Nominal apparent power (KVA)
<b>380V Class</b>					
1	A510-4001-S□3(F)	380	3.4	0.75	2.6
1	A510-4002-S□3(F)	380	4.2	1.5	3.2
1	A510-4003-S□3(F)	380	5.5	2.2	4.2
2	A510-4005-S□3(F)	380	9.2	3.7	7
2	A510-4008-S□3(F)	380	14.8	5.5	11.3
3	A510-4010-S□3(F)	380	18	7.5	13.7
3	A510-4015-S□3(F)	380	24	11	18.3
4	A510-4020-S□3(F)	380	31	15	23.6
4	A510-4025-S□3(F)	380	39	18.5	29.7
4	A510-4030-S□3(F)	380	45	22	34.3
5	A510-4040-S□3(F)	380	60	30	45.7
5	A510-4040-S□3(F)-B	380	60	30	45.7
5	A510-4050-S□3(F)	380	75	37	57.2
5	A510-4060-S□3(F)	380	91	45	69.3
5	A510-4075-S□3	380	118	55	89.9
6	A510-4100-S□3	380	150	75	114
6	A510-4125-S□3	380	180	90	137
7	A510-4150-S□3	380	216	110	165
7	A510-4175-S□3	380	260	132	198
7	A510-4215-S□3	380	295	160	225
8	A510-4215-S□3H	380	330	160	251
8	A510-4270-S□3	380	380	200	290
8	A510-4300-S□3	380	450	220	343
8	A510-4375-S□3	380	523	280	400
8	A510-4425-S□3	380	585	315	461
<b>220V Class</b>					
1	A510-2001-S□	220	5	0.75	1.9
1	A510-2002-S□	220	8	1.5	3
2	A510-2003-S□	220	11	2.2	4.2
2	A510-2005-S□3	220	17.5	3.7	6.7
2	A510-2008-S□3	220	25	5.5	9.5
3	A510-2010-S□3	220	33	7.5	12.6
4	A510-2015-S□3	220	47	11	17.9
4	A510-2020-S□3	220	60	15	22.9
4	A510-2025-S□3	220	73	18.5	27.8
5	A510-2030-S□3	220	85	22	32.4
5	A510-2040-S□3	220	115	30	43.8
6	A510-2050-S□3	220	145	37	55.3
6	A510-2060-S□3	220	180	45	68.6
7	A510-2075-S□3	220	215	55	81.9
7	A510-2100-S□3	220	283	75	108
8	A510-2125-S□3	220	346	90	132
8	A510-2150-S□3	220	415	110	158

④ CDM STANDBY LOSS	⑤		⑥		⑧		⑦		⑤		②		①		①		⑩	
	p Loss(W)	η(%)	p Loss(W)	η(%)	p Loss(W)	η(%)	p Loss(W)	η(%)	p Loss(W)	η(%)	p Loss(W)	η(%)	p Loss(W)	η(%)	p Loss(W)	η(%)	p Loss(W)	η(%)
14	2	0.0	2	0.0	95	0.0	23	93.1	30	93.8	40	94.1	30	95.5	44	95.6	45	95.9
14	2	0.0	2	0.0	95	0.0	28	93.2	35	93.9	46	94.1	35	95.7	53	95.8	55	96.0
20	2	0.0	2	0.0	95	0.0	47	93.4	57	94.1	72	94.4	60	95.9	77	95.9	78	96.2
23	2	0.0	2	0.0	96	0.0	77	94.1	92	94.8	160	95.1	117	96.1	170	96.2	190	96.4
23	2	0.0	2	0.0	97	0.0	93	94.6	119	95.2	220	95.5	140	96.7	230	96.8	240	97.3
33	2	0.0	2	0.0	97	0.0	109	94.9	137	95.6	240	95.8	147	97.2	260	97.3	260	97.5
33	10	0.0	10	0.0	105	0.0	129	94.8	164	95.5	301	95.8	168	97.3	348	97.4	404	97.6
35	10	0.0	10	0.0	105	0.0	174	95.0	216	95.7	370	96.1	220	97.4	420	97.5	430	97.7
35	10	0.0	10	0.0	105	0.0	239	94.9	264	96.0	450	96.3	282	97.5	510	97.6	520	97.7
35	10	0.0	10	0.0	105	0.0	279	94.8	313	96.0	555	96.3	338	97.5	605	97.5	605	97.8
40	10	0.0	10	0.0	105	0.0	343	94.8	388	96.0	690	96.3	396	97.6	740	97.6	740	97.9
40	10	0.0	10	0.0	105	0.0	343	94.8	388	96.0	690	96.3	396	97.6	740	97.6	740	97.9
40	10	0.0	10	0.0	104	0.0	511	93.6	630	94.8	1190	95.1	622	97.0	1350	97.0	1350	97.4
40	10	0.0	10	0.0	104	0.0	678	93.7	826	94.8	1380	95.1	786	97.1	1480	97.1	1480	97.5
40	10	0.0	10	0.0	105	0.0	725	94.6	954	95.3	1630	95.6	985	97.2	1650	97.3	1660	97.7
42	50	0.0	50	0.0	96	0.0	758	93.7	1060	95.3	1888	95.7	1139	97.1	2076	97.4	2130	97.6
42	50	0.0	50	0.0	144	0.0	900	93.7	1269	95.3	2293	95.7	1364	97.1	2526	97.3	2594	97.5
46	50	0.0	50	0.0	143	0.0	1160	93.3	1624	95.0	2894	95.5	1738	97.0	3165	97.2	3243	97.4
46	50	0.0	50	0.0	143	0.0	1388	93.3	1958	95.0	3531	95.4	3778	96.8	3858	97.2	3951	97.4
46	50	0.0	50	0.0	144	0.0	1321	94.3	1881	95.7	3457	96.0	2037	97.4	3827	97.5	3934	97.7
56	50	0.0	50	0.0	144	0.0	1474	94.4	2085	95.8	3780	96.1	2259	97.4	4194	97.6	4313	97.7
56	100	0.0	100	0.0	194	0.0	1740	94.2	2458	95.7	4464	96.0	2658	97.4	4267	97.9	5078	97.7
56	100	0.0	100	0.0	194	0.0	2191	93.9	3089	95.4	5559	95.8	3326	97.2	4946	97.9	6285	97.6
56	100	0.0	100	0.0	194	0.0	2538	93.9	3600	95.4	6546	95.8	3875	97.2	5961	97.8	7391	97.6
56	100	0.0	100	0.0	195	0.0	2339	94.9	3355	96.2	6225	96.4	3663	97.6	6410	97.9	7170	97.9
13	2	0.0	2	0.0	96	0.0	23	93.8	26	94.9	42	95.2	36	95.5	46	95.5	47	95.7
19	2	0.0	2	0.0	95	0.0	40	93.4	49	94.1	54	94.3	53	95.8	58	95.8	60	96.0
19	2	0.0	2	0.0	96	0.0	61	94.0	72	94.6	88	94.9	82	96.0	89	96.0	90	96.2
20	2	0.0	2	0.0	96	0.0	95	94.1	112	94.8	115	95.1	133	96.3	120	96.4	122	96.5
30	2	0.0	2	0.0	96	0.0	135	94.1	159	94.8	162	95.1	180	96.5	169	96.6	185	96.6
30	2	0.0	2	0.0	96	0.0	144	93.9	186	94.6	285	94.9	189	96.7	291	96.8	310	97.0
30	10	0.0	10	0.0	104	0.0	170	93.9	223	94.6	385	94.8	259	96.6	425	96.6	435	96.9
31	10	0.0	10	0.0	104	0.0	215	94.1	281	94.7	465	95.0	313	96.7	495	96.8	525	97.0
32	10	0.0	10	0.0	104	0.0	284	94.1	408	94.3	692	94.4	465	96.2	758	96.3	758	96.7
35	10	0.0	10	0.0	104	0.0	335	94.4	478	94.6	855	94.7	504	96.6	865	96.7	875	97.1
35	10	0.0	10	0.0	105	0.0	422	94.9	598	95.1	1035	95.2	656	96.8	1095	96.9	1125	97.0
36	50	0.0	50	0.0	143	0.0	469	93.0	655	94.8	1167	95.3	732	96.7	1164	97.4	1401	97.1
36	50	0.0	50	0.0	143	0.0	571	93.2	809	94.9	1473	95.2	904	96.7	1453	97.4	1764	97.1
46	50	0.0	50	0.0	143	0.0	663	93.0	935	95.0	1695	95.4	1048	96.8	1567	97.6	2042	97.2
46	50	0.0	50	0.0	143	0.0	859	93.4	1234	95.0	2304	95.3	1383	96.8	2031	97.6	2761	97.1
56	100	0.0	100	0.0	193	0.0	1089	93.2	1532	94.9	2768	95.4	1714	96.8	3202	97.0	3326	97.2
56	100	0.0	100	0.0	193	0.0	1253	93.5	1776	95.1	3231	95.5	1995	96.9	3752	97.0	3901	97.2



**TECO Electric & Machinery Co., Ltd.**

10F., No.3-1, Yuancyu St., Nangang District,

Taipei City 115, Taiwan

Tel :+886-2-6615-9111

Fax :+886-2-6615-0933

<http://industrialproducts.teco.com.tw/>



Distributor

4KA72X583T61 Ver:10 2021.06

---

This manual may be modified when necessary because of improvement of the product, modification, or changes in specifications, This manual is subject to change without notice.