

Product data sheet Emotron

Variable speed drive FDU69-006-54/ 4KW/ 400-690V

Main Features

- NEW - Control panel with Real time clock. Optional Bluetooth communication.
- Available as robust and certified IP54 metal construction or IP20/21 version.
- All drive sizes are delivered with built-in Category C3 EMC-filter as standard. C3 requirements are fulfilled with 80 m motor cable (IP2Y= 25m).
- Soft starts minimize start currents and linear stops prevent water hammer.
- One Emotron FDU can control up to seven pumps/fans without external control systems.
- Energy saving function pauses the motor when it is not required to run to maintain pressure.
- Efficiency is increased by setting the pump to run at full speed at certain intervals to rinse out sludge.
- Temp/Speed controlled fans assures less noise, a more even drive temperature and higher efficiency.
- Load monitor function included as standard.
- Detachable multi-language control panel included as standard. Following languages are supported in the control panel:
English, Swedish, Dutch, German, French, Spanish, Russian, Italian, Czech, Turkish and Polish.
- Operation parameters can be set in your process units, for example m³/min. and bar.
- Removable control panel with own memory means it is easy to transfer or copy settings.
- UL (UL 840) approved version available (not IP2Y).
- Marine (DNV-GL & BV) approved version available (not IP2Y, IP2x).
- Liquid cooled version available for sizes above 90 A

Product data sheet

GENERAL SPECIFICATION

Component name	FDU69-006-54
Suitable Motor Capacity Capacity(KW)	4
Rated Output Current(A)	6
Maximum Output Current(A)	9.6
Input Voltage Range(V)	Three-phase 400~690V, 50/60Hz
Allowable Voltage Fluctuation	-15%~+10%
Output Voltage range(V)	Three-phase 0~480V
Mains Frequency (Hz)	45 to 65
Output Switching Frequency (kHz)	3
Input Power Factor (%)	0.95
<i>Environmental conditions</i>	
Nominal ambient temperature	0°C - 40°C (32°F- 104°F)
Atmospheric pressure	86–106 kPa (12.5 - 15.4 PSI)
Relative humidity according to IEC 60721-3-3	Class 3K4, 5...95% and no condensing
Contamination, according to IEC 60721-3-3	No electrically conductive dust allowed. Cooling air must be clean and free from corrosive materials. Chemical gases, class 3C2 (coated boards 3C3). Solid particles, class 3S2.
Component name	VFX48-2K5-54
Vibrations	According to IEC 60068-2-6, Sinusoidal vibrations: 10<f<57 Hz, 0.075 mm (0.00295 ft) 57<f<150 Hz, 1g (0,035 oz)
Altitude	0–1000 m (0 - 3280 ft) with derating 1%/100 m (328 ft) of rated current
Storage temperature	-20 to +60 °C (-4 to + 140 °F)
Storage atmospheric pressure	86–106 kPa (12.5 - 15.4 PSI)
Storage relative humidity according to IEC60721-3-1	Class 1K4, max. 95% and no condensing and no formation of ice.
<i>Basic I/O Data</i>	
<i>Control signal inputs: Analogue (differential), 4 channels</i>	
Analogue voltage/current	0-±10 V/0-20 mA via switch
Max. input voltage	+30 V
Input impedance	20 kΩ (voltage), 250 Ω (current)
Resolution	11 bits + sign
Hardware accuracy	0.5% type + 1 ½ LSB fsd
Non-linearity	1½ LSB
<i>Digital inputs: 8 channels</i>	
Input voltage	High >9 VDC, Low<4 VDC
Max. input voltage	+30 VDC
Input impedance	<3.3 VDC: 4.7 kΩ , ≥3.3 VDC: 3.6 kΩ

Product data sheet

Signal delay	≤8 ms
<i>Control signal outputs: Analogue, 2 channels</i>	
Output voltage/current	0-10 V/0-20 mA via software setting
Max. output voltage	+15 V @5 mA cont.
Short-circuit current (∞)	+15 mA (voltage) +140 mA (current)
Output impedance	10 Ω (voltage)
Resolution	10 bit
Maximum load impedance for current	500 Ω
Hardware accuracy	1.9% type fsd (voltage), 2.4% type fsd (current)
Offset	3 LSB
Non-linearity	2 LSB
<i>Digital outputs: 2 channels</i>	
Output voltage	High>20 VDC @50 mA, >23 VDC open Low<1 VDC @50 mA
Short-circuit current (∞)	100 mA max (together with +24 VDC)
<i>Relays, 3pcs</i>	
Contacts	0.1 – 2 A/Umax 250 VAC or 42 VDC
<i>Reference voltages</i>	
+10 VDC	+10 VDC @10 mA short-circuit current +30 mA max
-10 VDC	-10 VDC @10 mA
+24 VDC	+24 VDC short-circuit current +100 mA max (together with Digital Outputs)

Product data sheet

PERFORMANCE

Control performance for Emotron VFX 2.0 (Speed)

Speed control static accuracy
(linearity):



Closed loop = 0.01% of n_{nom} .
Open loop = 0.1% of n_{nom} .

Control performance for Emotron VFX 2.0 (Torque)

Torque control static accuracy
(linearity):



Closed loop: <3% of T_{nom} .
Open loop: <3% for speeds 10 - 100% of rated,
and <10% at zero speed (% of n_{nom}).

Speed Control dynamic accuracy
(impact drop):



Closed loop = 0.2%sec (100% load step)
Open loop = 0.4%sec (100% load step)

Torque control dynamic accuracy:



Closed and open loop:
100% torque step rise time = 1 ms.

Control performance for Emotron FDU 2.0 (V/Hz)

Speed control accuracy =
approximately 1% of n_{nom}
(slip frequency).

Torque accuracy =
approximately 5% of T_{nom}
(20 - 100% speed).

Product data sheet

GENERAL WIRING DIAGRAM

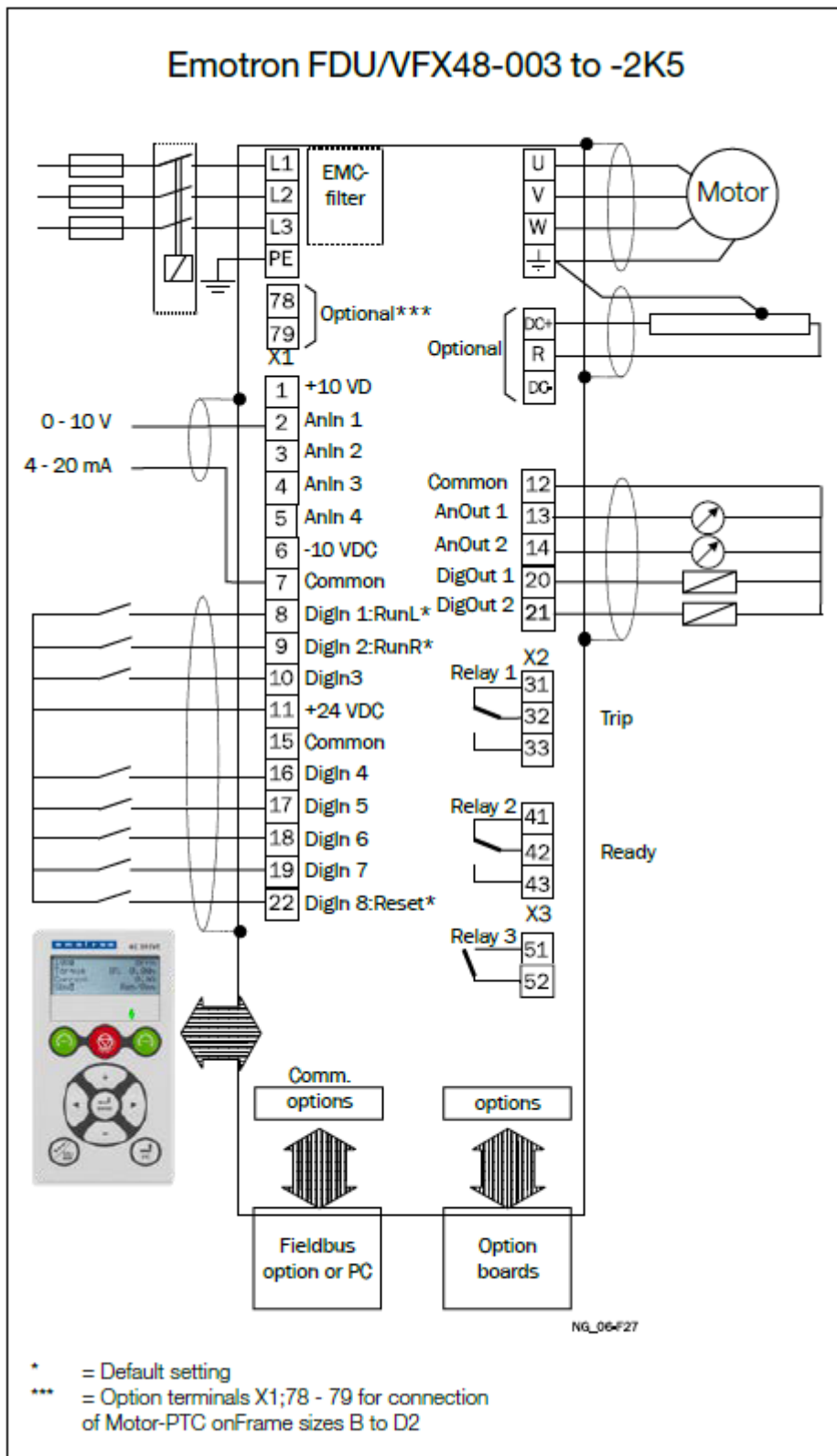

Product data sheet

X1	Name:	Function (Default):
1	+10V	+10 VDC Supply voltage
2	AnIn 1	Speed reference
3	AnIn 2	Not Used
4	AnIn 3	Not Used
5	AnIn 4	Not Used
6	-10V	-10VDC Supply voltage
7	Common	Signal ground
8	DigIn 1	RunL
9	DigIn 2	RunR
10	DigIn 3	Not Used
11	+24VDC	+24VDC Supply voltage
12	Common	Signal ground
13	AnOut 1	Min speed to max speed
14	AnOut 2	0 to max torque
15	Common	Signal ground
16	DigIn 4	Not Used
17	DigIn 5	Not Used
18	DigIn 6	Not Used
19	DigIn 7	Not Used

X1	Name:	Function (Default):
20	DigOut 1	Ready
21	DigOut 2	Brake/No trip
22	DigIn 8	Reset
X2	Name:	Function (Default):
31	N/C 1	Relay 1 Output= Trip. Active when the AC drive is in a Trip condition. The N/C is opened when the relay is active (valid for all relays). The N/O is closed when the relay is active (valid for all relays).
32	COM 1	
33	N/O 1	
41	N/C 2	Relay 2 Output= Ready. Active when the AC drive is ready to start.
42	COM 2	
43	N/O 2	
X3	Name:	Function (Default):
51	COM 3	Relay 3 Output= Not used.
52	N/O 3	

DRIVE DIMENSIONS

(Hx Wx D): preliminary 512x 178x 314 (mm).



Head Office, Sydney

TECO Australia Pty Ltd
335-337 Woodpark Road,
Smithfield NSW 2164
Tel: 02 9765 8118
Fax: 02 9604 9330



Melbourne

TECO Australia Pty Ltd
16 Longstaff Road,
Bayswater VIC 3153
Tel: 03 9720 4411
Fax: 03 9720 5355



Brisbane

TECO Australia Pty Ltd
50 Murdoch Circuit,
Acacia Ridge QLD 4110
Tel: 07 3373 9600
Fax: 07 3373 9699



Perth

TECO Australia Pty Ltd
18 Hazelhurst Street,
Kewdale WA 6105
Tel: 08 9479 4879
Fax: 08 9478 3876



New Zealand

TECO New Zealand Ltd
Unit 3, 477 Great South Road,
Penrose, Auckland
Tel: 64 9-526 8480
Fax: 64 9-526 8484
sales@teco.co.nz